



SCACOM Disk: Gold Quest 4

Interview with Michael Krämer

Interview with Bender

Commodores Patents

Games Convention 2008

Best C64 Games List



***The beautiful things in life are
free of charge!***



www.scacom.de.vu

***English*.SCACOM**

The magazine for all Commodore and Amiga fans - free of charge

Prologue

English SCACOM issue 4 comes with a special version of the game "Gold Quest 4" and lot of interesting articles!

A lot of news from the last three month and two interviews are included in this issue. You can also have a look at the Retro-corner on the Games Convention 2008. Also included is a very interesting article about patents from Commodore as well as the last part of our "C64 game list". Try our word search, look at the comic and find the solution of our game show!

Sad news: This is the last issue of English SCACOM because of the fact that it's a lot of work. Thanks to all fans and people supported our project!

Write an E-mail to
stefan_egger2000@yahoo.de.

Thanks to...

Camailleon
Christophe Kohler
Christian Rehberg
Michael Krämer
Telespielator

Who can help?

Everybody! Please send your text to me with your computer story or pictures!

What articles are in the SCACOM-magazine?

There are Tutorials, stories about experiences with Commodore computer, Interviews, Background pictures and other interesting stuff in our English SCACOM magazine.

I hope you like our homepage and the magazine! Have fun!

Imprint

English SCACOM is a free downloadable PDF magazine. It's scheduled every 3 months.

You can publish the magazine on your homepage without changes and link to www.scacom.de.vu only.

Each author has Copyright of articles published in the magazine. Don't use without permission of the author!

The best way to help would be if you write some articles for us.

Please send suggestions, corrections or complaints via e-mail.

Editorial staff:

Stefan Egger
Joel Reisinger
Michael Kronsteiner

Contact:

stefan_egger2000@yahoo.de
www.scacom.de.vu

Content

Picture of the month.....	4
News.....	6
Interview with Bender.....	9
Background picture.....	12
Interview with Michael Krämer	13
SCACOM Disk.....	15
Bobble Bubble.....	16
Games Convention 2008.....	17
Commodore Patents.....	19
The Innovative Museum.....	21
Feedback.....	22
Baracudas story.....	23
Best C64 Games List.....	24
Disk-cover for „Gold Quest 4“.....	27
Word search.....	28
Comic / Game Show.....	29
10 reasons / Some final pictures.....	30





Number of the month

A C64 Gold Edition was available at eBay. It costs 3343,33 Euro.



Book of the month

Brian bagnallinterviewd Jack Tramiel in the new book: "On the Edge - The Commodore Story" will be available in Februar 2009.

Hardware of the month

The seller of a rare Video-Module of the never-released CDTV CR got 3,83 Euro for it.

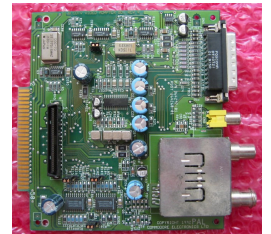

Picture of the month

A young Commodore fan: The boy plays "Giana Sisters" installed with WHD load on an A1200.

The picture was shot on the "Commodore Meeting" in Vienna in 2008.

It's nice to see that the young Gernation loves the old Commodore machines and games too!

News

WHD load

There are new and improved WHD slaves available for download!

www.whdload.de

1541U

A second and third batch of the 1541U is in production. If you pay +40 Euros you can get a unit with Ethernet connection. Also there is a new Firmware-Update (v1.1.) available.

www.1541ultimate.net

C64 .prg Generator

With this program you can write a BASIC program under windows-environment! Additional features:

- Program import (.prg, .T64 or .D64)
- Sprite editor
- Character Editor
- Binary import/export
- Code formatting

www.ajordison.co.uk/index.html

VICE for Amiga

The emulator simulates some VICE Commodore 8-bit systems. The new version 2.0 is available for AmigaOS 3.x/4.0, AROS (x86, PPC, x86-64) and MorphOS available.

www.viceteam.org/amigaos.html

Sub Hunter

You can now pre-order the game called "Sub Hunter" by Richard Bayliss! For £ 3.99 you get 25 underwater levels on cassette and a beautifully designed cover. Available in October 2008.



www.binaryzone.org/retrostore/index.php?main_page=product_info&cPath=82&products_id=430

Natami

The developments on NatAmi are finished to produce the first prototype. The Amiga clone is a not cycle-exact reimplementation of the Amiga custom chips. It is compatible with AGA and even has an improved chipset called SuperAGA

www.natami.net

PSP-UAE 0.72

The new UAE version 0.72 for PSP systems fixes some bugs such as the centering of the image in 4:3 mode. It also seeks no crashes when you press the home button. If kickstart 1.3 is not found, the emulator will search for the next higher version and will use them.

The developers want the speed of the version 0.70 or a little faster.

<http://pspuae.condor.serverpro3.com/>

Super Methan Brothers PSP

There is a new PSP adaptation of the classic Amiga platform game by Apache Software.



The game will only work on custom PSP 3.XX and 4.XX firmwares.

Copy the folder with the game files to ms:/PSP/GAME (or ms:/PSP/GAMEXXX where XXX is your custom firmware's version).

DOWNLOAD

http://deniska.dcemu.co.uk/bin/SMB_PSP.rar

iGame

The MUI-based user interface for WHD-Load Games is available in new version 1.5.

- genres are now in an external file
- "Never played" list
- Improved function "Show / Hide hidden slaves"
- Filter also works with genres
- Select the added writing to disc

Commodore T-Shirts

Commodore Gaming now sells Commodore T-Shirts.



www.commodoregaming.com

On the Edge: new book

The second, expanded edition of On the Edge includes information from marketing guru Kit Spencer, chip designer Bill Mensch and Commodore Cofounder Manfred Kapp. Also CEO and President Jack Tramiel was interviewed from Brian Bagnall!

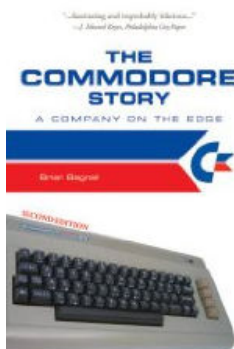

WinUAE 1.5.2

Since 1.5.1 had a bug version 1.5.2 is available! There are some small improvements and an experimental support for OpenAL sound. Also you can save your ROM paths in a file.

C64-Forever announced

Cloanto – known from Amiga Forever – announced a software-package for C64-fans.

www.c64forever.com

Space Invaders

The game with the space battles celebrates his 30th birthday. Happy birthday!

VICE v2.0

The Commodore emulator VICE in version 2.0 is available. It contains emulators for C64, C128, VC20, PET / CBM and the C264er series. A new feature let us copy text from the VICE window. All new features:

<http://www.viceteam.org/plain/NEWS>

Download:

<http://www.viceteam.org>

VICE for iPhone

Now also VICE is also available for the Apple iPhone. It's easy to write on the virtual keyboard because of the built in touchscreen. But it's hard to play, because the phone has no keys. As with the PSP you have to hack the firmware to start the emulator.

XS 1541 adapter

The famous cables of the X1541 series are a bridge between IEC interface at the Commodore computer and the printer port on the PC. But modern PCs don't have such a printer port. The XS-1541 adapter now uses either the serial port or a USB port. In addition you can use normal Commodore IEC bus as well as the IEEE standard found on the PET / CBM series of computers.

Projekt 64JPX

The "Joy Port Extender" called project makes it possi-

ble to use 4 or 6 buttons Sega game pads on the C64. SNES and PC controllers should also be supported.

C64 Emulator CCS v3.6

The popular C64 emulator is published with some improvements.

<http://www.computerbrains.com/ccs64/>

Commodore Free issue 22

Issue 22 of Commodore Free is available. You can download it in html, pdf, txt 40 column and seq file format.

www.commodorefree.com

Minimig: new Core

A new update fixes some existing errors and now offers the opportunity to write your highscores onto ADF files!

Update: Amiga Forever

An update for the Emulations package introduces a new format. Besides ADF and other well-known file extensions there is now also the new .Rp2 (retro Platform player) format. The justification for the introduction is that games with multiple disks are easier to start.

10 years amiga-news!

amiga-news had it's 10th birthday! Congratulations from us!

www.amiga-news.de

Cannon Folder: new Levels

72 level in 24 new missions are available for the shooter Cannon Fodder. The level

design as well as some sprite graphics changed. You can install the game with WHD load.

www.ppa.pl/cannonfodder

Wireless: RForce

RForce is an adaptor that transmits the signals of two joysticks wirelessly. The piece of hardware designed by joca-tech will have low power consumption (about 35 hours of play). It is compatible with many home computers that use the standard 9-pin connector. The response time is very good; a distance of 5 meters is not a problem, according to the developers. There are different versions available: a complete set will cost around 70 euros.

www.joca-tech.de

New Commodore Laptop

Commodore announces a new small and mobile laptop. For about 370 Euro you will get a laptop with 10-inch display, a 1.6 GHz VIA C7-M processor, WLAN, 1 GB of RAM and a 80 GB hard drive. The name of the new hardware is UMMD (ultra mobile media device) 8010 / F.

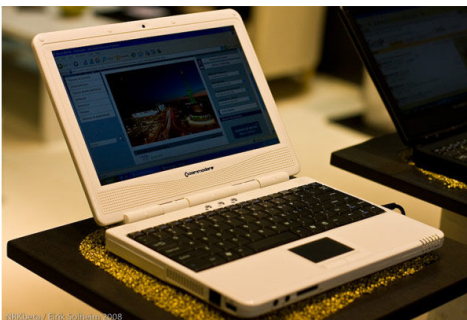

www.commodorecorp.com

Indivision AGA

The new Flickerfixer is available for 129 Euro. It's only compatible with the Amiga 1200. A later version will be compatible with A4000 and CD32. The Flicker fixer works without drivers, and can display all Workbench modes in VGA signals (only A2024 monitor driver is not supported). Colors are 100% the same on VGA displays and with 24 bit you get the full color depth of AGA. The product is based on FPGA and can be updated thru software.

www.jschoenfeld.com/news/news130.htm

CloneA

Finally there's some information on the Amiga clone of individual computer. In November or December, the technical data should be completed and published. Production and sales are planned for Q3/2009. The video output of Clone-A is based on Indivision AGA, but it is not identical.

C64 Radio

Radio 6581 plays SID tunes, C64 remixes and live shows.

www.Radio6581.com

1541U Update

Since Friday the 18th July the first update to the 1541U is available!

To upgrade to version 1.1 you have to download a .zip file from the homepage of 1541U. The update is only for PAL

regions. An NTSC version follows later.

- 1) Extract the .Zip file into the Root (sd0: \) directory.
- 2) put the SD card in the 1541U
- 3) Turn on the C64/C128 computer.

The C128D tested from us booted in BASIC v7.0. The update has still worked because it is done internally in the 1541U. It is a very safe process. But if something goes wrong, we are not liable for damages.

What has improved?

- Improved 6502 emulation
- The loading of Action replays will now work better.
- IEC pins of 8 mA to 16 mA respectively, which emit the problem in 1541-II should be fixed ..
- REU emulation has been greatly improved
- Minor swie the command "CD /" in the software IEC mode

What has been added?

- Retro Replay emulation
- Super Snapshot V5 emulation, with 32K of RAM
- Swap reset / freeze function buttons
- Hiding files, with ' . ' launch

300 articles in C64wiki

The first 300 articles: The time to do that was exactly 1 year, 10 month and 24 days.

www.c64-wiki.com

Interview with Bender

Stefan Egger (translated by Camailleon)

We talk to Christian Reberg ("Bender") who has the German website www.classiccomputer.de Homepage

Hello Bender, please introduce yourself!

My name is Christian Reberg, I live in Dortmund and I collect old computers. Was that all?

Why "Bender"? I suppose because of the TV series...

Yes, because of the robot from Futurama.

How did you get to the Forum64? When did you enter it for the first time?

I entered the Forum64 via internet (silly question), it was first in 2003. So soon kind of a 5th anniversary. Except for some wimps and the con men from the forum I quite like it. But most of the idiots are gone as fast as they appeared. It is the same as in real life.

When and how did you have the first contact with computers?

The first contact was at school, there were two rooms, one was full of CPC 6128s and one full of C 64s. Unfortunately the room with the C 64s was always closed because some people had a lot of fun destroying them and they also sometimes shut down while in running state. Therefore my first computer was the CPC, my first own

computer was a Sinclair Spectrum + which I had bought from a colleague at school. But the story is now well-known.

I read on your homepage that you got back your "first one". Please tell us how you made this and what it means to you!

I got the computer from HOL2001 in exchange for some VCS cartridges and money. Unfortunately the Sinclair turned out to be broken after sending. In case you should read this, Holger, I hope your cartridges break too (which usually happens quickly and these are then brought along to the next party ☺), joking aside, I am really grateful to him. I put it into my small shelf, so I can always see it. Sounds silly, but this was a very special

"first time". To play Space Invaders for the first time on a TV screen, was really great. Unfortunately, the Interface 2, which I owned at that time, is very rare and hard to find. If anyone wants to get rid of it, I will instantly be ready to provide money or other actions.

What computers did you own after the Sinclair Spectrum?

After the Sinclair I had a C 64 C from Media Markt for 279 DM. Then after a few years there was a PC20 III at a time when everybody already had a 286 or a 386SX. The PC 20 then disappeared quickly and an ASI 386 SX 20 appeared soon. This one had cost a lot of chips and was soon upgraded with Soundblaster and CD ROM. Then came a TEMA TC (Brinkmann own label) 486 DX 33 and the fol-



lowing time it was only randomly upgraded (Pentium 75 and up to the 1,8 GHz Athlon XP today).

Which was your first Commodore computer?

A Commodore 64 C, as already said, of which still today I own the original wrapping and the whole computer exists. It came back to me over a funny way. I had to sell it at that time, "there will only be a new one, when the old one is gone". That's the way my parents were, without foresight. Then it was gone for years and somehow I didn't think of it. Although I was totally in love with this thing, I even (don't laugh) had put it back into its original wrapping before going on holiday, so nobody else could use it. That way it was sold and then it was gone. Someday came the Amiga 500 for a friend into the house, but he said: "No, go away with this

thing, the playstation is available." So then I had an Amiga 500 with a complete equipment. Unfortunately, due to the history it was for me as a C 64 fan not allowed to attend to an Amiga. At that time an Amiga was seen as a machine for snobs at our school, the only guy at our school that owned an Amiga was a self-important pimple head who nobody really liked. And sometime, however, I pulled it out and after playing some rounds of Rick Dangerous and Out Run I was lost again. And so the first purchase of a C 64 over Revier Markt began. Then came ebay and you still could make a bargain. So I bought an C 64 and another one and one day there was an answer mail after a purchase: „This must be a joke, am I on Candid Camera?“ I phoned him and I found out that I had bought at the auction my own C 64 (it was living in Hamburg now).

The disks and disk boxes and even the cartridges still had my own the labels of the old days. Absolutely fantastic, after 12 years my own C64 was standing in front of me again. And there it is still today. Here you can take a look into Benders kid's room (already then I had robots at the wall ☺):

Why are you more a Commodore Fan? What fascinates you on a C64 and Co?

Herd instinct, there were hardly any alternatives. Everything else was gone and all the world talked about the C 64. So I had to have one too, with the advantage that every grandfather had the software for it. Fascinating? Well, it is more the memory of an easier and less complicated time, when 1 MHz meant the world.

Did you also have an Amiga?

As already mentioned above the Amiga was kind of discredited at our school and the truth was, that it was with a price of 900 DM so horribly expensive, that hardly anybody could afford it. Which of it is in line with truth can anybody figure out for himself.

Which computers do you use today?

Most of the time I use a PC, be it at home or at work. SAP doesn't run on a C 64 and my boss



puts up a weird look, when I want to plug it in there. Otherwise the choice kind of changes, but the C 64 is ready-for-use most of the time. Then I use also an Amiga or alternatively a Schneider CPC or a MSX or sometimes an Atari XL or a ST. I simply use what I am in the mood for.

What computers and game consoles do you own today?

Take a look at my page and you know what I own. With consoles I am a grad Super Nintendo Fan. This console ist just fantastic, uncomplicated and great concerning fun and entertainment. Also I like the PS2, the old X-Box has ist charm, same as the Dreamcast. I also own other consoles as Jaguar and Saturn, but rather more for collection reasons.

I know you had a very big collection! Why is it all gone now?

It got out of hands. And because of the fact that I don't really need about 60 C 64 and as many floppies, the whole stuff went to Magdeburg and a big part to Italy. The rare parts and donations stayed with me. If you now ask yourself, what the things do in Italy, they are used in a retro amusement arcade. A great thing which I was happy to support. There will be a big report about this soon. I am in contact with a rather known writer, who likes picking up such topics. Furthermore my family is also to be "blamed",

so it was also necessary to do a step there. But only the double and threefolds disappeared, every computer is still there at least once. Moreover I gave my word of honour that the donations to the museum will not be sold. This was also a reason for why I didn't accept an AS400 and a very old Olivetti calculating machine as a donation. They probably would have exceeded the dimensions.

Family? How ist he little kid?

Sonny is fit, he is alive and kicking. He is also already very good at using computers. He is a sunshine.

Do you catch yourself filling the cellar with computers again?

Unfortunately, yes. I just can't help it. Every C 64 on the boot sale is taken home, my old connections still supply me with lots of hardware. And I rather make sure it gets back to the cycle, before it might go into the trash bin.

We had a 264 special edition about the C16 and Plus/4... What do you think about these computers?

Ugh...shake. Next question.

You have very good homepage! Why did you make it?

With Microsoft Frontpage ☺ But actually I could blame Christian Zahn for it. After my first steps on the Internet, I found his page and I was fascinated for days. Such a great thing, to look at everything

and all the info. But as it is sometimes, you always find something to improve. I didn't like the photos and the infos were rather unemotional. I wanted to do that better. And I managed it, as some people told me.

You once wanted to create a C 64 page with tips and hardware etc. Then the project died. Why?

Yes, the C64 World. It's a pity, but I couldn't bring up the power to take care of this project alone. Sounds silly, but until something like that is put up in all its diversity, that is a lot of work. And also the other page

www.classiccomputer.de

needs caring. But maybe the project will rise again. The thought is good, a conversion would be possible in another shape as well. There are so many good ideas and tips which simply get lost in the Forum64 or are asked for again and again. So I wanted to create a kind of collecting point. There is the C64 Wikipedia, but I don't think much of it. It is a good overview for people who know the scene and know the established terms. But the average fool and ebay C 64 buyer is absolutely overwhelmed. It should get a memorial for everything that makes the C 64. But it is put on hold for now...

You have a cooperation with C64 online page! Until now I haven't noticed it – what exactly is it?

I didn't notice that much of it either, it kind of fell asleep from my side. I will contact Thomas again, a very nice contemporary, who I was allowed to welcome on the DoReCo. It is great but unfortunately the forum is rather inactive. But the choice of the domain might be wrong, under a COM address most of the people assume an English or a commercial page. And it is none of both. And the colours in the default settings are rather daunting and too dark. But this is his thing. Let's see what the time brings, in any case the cooperation will be pushed and advanced.

You are part of the CeviAktuell. What do you do there? Why and since when do you do that?

Every now and then I write down my small mental blackouts and send them to Boris, who then really prints them (and oh wonder I sometimes get some feedback).

How did you get the idea for the 2 floppies in the hobby room, which I really like?

Sometimes I think in our cellar there is something in the air which kind of confuses me, then you hear some floppies talk. But else I feel fine.

What do you think of this (SCACOM) magazine? Was it a good or a redundant idea? Where do you think is the difference to existing magazines?

Nothing where you express your emotions and communicate your fun is superfluous. And one notices this clearly in this magazine, it is created with a lot of love and one cannot deny that you have the right touch for it. It is okay, that you express your opinion that you make your own magazine and you go through with this thing. There is always a hassle, be it a new issue, a new website or a new hairdo. And when you look at the people who make a fuss about you and your website or trash-talk, these are always the same. Envious are always there. Nothing bad can be found about your magazine.

What wishes or projects do you have for the future?

To extend the cooperation with C64-Online, to get a SX 64 again (one of the biggest mistakes to give it away), maybe to realise the C64 World, to find a C 65 on a boot sale, to find a C 64 Gold at the roadside, there are so many things. But the private things preside over these and are more probable to reach. And the first things are now moving and a new car.

Thank you for the interview. Is there anything you want to get rid of?

Ah, leave me alone..... ☺

Background pictures

Stefan Egger

I've created some special background pictures with a program called "MicroStation" from Bentley. It's software for rendering and often used by architects. I learned to use this program in school.

There are two Background picture included with this magazine. The first picture shows an Amiga A1011 disk drive. The second picture shows a Commodore 1571. They have a resolution of 1280x960 pixels in JPG format.

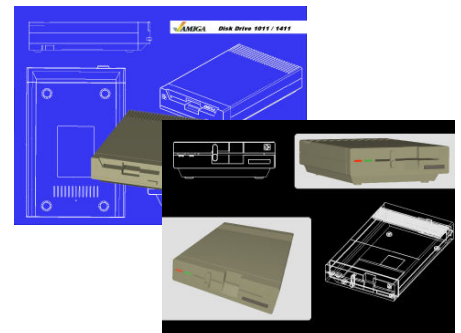

Download further background pictures in our gallery at www.scacom.de.vu:

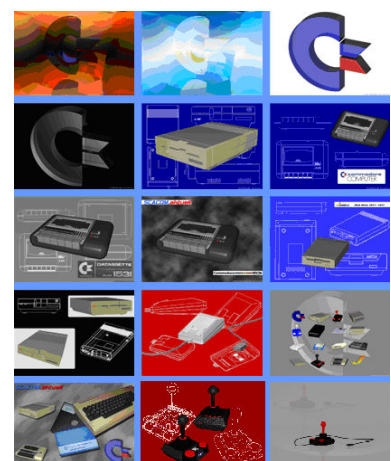

Interview with Michael Krämer

Stefan Egger (translated by Camailleon)

We made an interview with Michael Krämer, a member of the Cevi Aktuell editorial staff.

Hello Michael Krämer (of the Cevi Aktuell editorial staff, a German C64 magazine in PDF format), please introduce yourself and your hobbies in detail!

Alright... *laughs* ...as you already know, my name is Michael Krämer but I am also known under the alias 8R0TK4\$T3N (or short: Broti). At least I hope that :) ; I am 21 years old and live in Moers which lies at the wonderful Niederrhein.

My hobbies are of course classic computers as well as non-technical things as making music or playing chess/XiangQi. I am also a big friend of DVDs and I organise film nights with friends regularly or I am out and about somewhere with people I know.

What do you do along with your hobbies?

Next to my hobbies I am amongst others working for the Digital Talk, Cevi-Aktuell and Protovision. Additionally I have my finger in the pie of different other projects (not C64 oriented).

I've heard that you make movies and/or rework them. Tell us something about the film-making side of you!

That's right. I both film and rework and of course I have my finger in image editing. Actually it all began with two friends and me filming short clips with a digicam (max. 30 seconds). Later we switched to a real camera.

That way even bigger and more senseless films evolved. Then it came over us to synchronise something. So we created parodies of „Lord of the Rings“ and „Matrix“. In 2005 there was a film competition (I forgot by whom) and there we made our first serious movie of about 45 minutes for our school. Meanwhile the film-making is limited to home videos of parties and such things. Although I still have a screenplay for a silent movie in my drawer. But if and when I will put it into action is still written in the stars.

When and how was your first contact with computers? Which was the first one you had at home?

The first time I could know the promise of a computer I was 4 years old, when my father brought home a C64 with a 1541 and a green monochrome monitor.

Which computers did you own after that?

Later an Amiga 500 and a 486 with 50MHz were added. And then bit by bit PCs which were a bit better ;).

What classic computers or game consoles do you own nowadays?

I still own about eight or nine C64 (different models, could also be more :)), three C16, one C128, two Amiga 500, one Amiga 600, one IBM PC 300XL, one C-286-LT, one Atari VCS 2600, four Game Boys (ok, it is a handheld, but still somewhat „retro“ ;)) and a Poppy 9012 television game.

What is this Poppy 9012 television game that you mentioned?

The Poppy 9012 television game is a TV game from 1977 (I don't know anything about the manufacturer). It is a pong clone with 6 integrated games. These are: tennis, hockey, squash, handball, skeet shooting and battue. You either play with paddles or as the case may be with the gun.

Which of those is your favourite system and why?

My favourite system is and will always be the C64, because I grew up with it. You are kind of attached to it like

to your first pet or cuddle animal.

Why are you more a Commodore fan? What is fascinating about the C64 and co.?

On the C64 I was always fascinated by the ingenious and unique sound and it still does today. I also loved how much you could get out of this box, despite of its limits.

What are your top 5 of Amiga and C64 favourites?

On the Amiga this would be (without any order): The Secret of Monkey Island, It came from the desert, Lionheart, Turrigan 3 and Indiana Jones and the fate of Atlantis (if you played it, you know what it means to play a disc jockey *laughs*)

C64 (same here, no order): Archon 2, Turrigan, Super Nibbly, The Great Gianna Sisters and Mrs. Pac-Man

You are co-founder of the Cevi Aktuell (next to Boris Kretzinger). Tell us about the birth of the "Cevi"!

Well... *thinks* it started, when I had a letter from Boris Kretzinger in my mailbox, in April 2005. Inside was a folded piece of paper with one and a half pages of text, in which Boris asked, if I would like to support this project. I agreed of course, as I already knew Boris from our work on the Digital Talk, so I wrote a report about the MMC64,

which had been issued recently at that time. And so the Cevi Aktuell was born.

The magazine only contains topics on the C64. Why is that? What brought you to that? Isn't it hard to fill the magazine?

Now then, as the name already implies, it revolves around the C64. At the time when the Cevi-Aktuell evolved, there was no mere C64 magazine, which was for free. Of course it is hard to fill a magazine, you probably also know that.

What exactly is your job?

My tasks comprise the typical editorial work, which is looking for topics, translating sources if necessary, etc. Furthermore I also take care of our web site. I took over this task from the start, as Boris has a little less knowledge in HTML than me.

You worked amongst others with me on Gold Quest 4 by Thorsten Schreck. What did you do? What was the biggest bug you found?

Well, I played the game together with others and reported bugs. I would say, the greatest bug was probably the highscore error in the 2-player mode, where all the collected points were ascribed to the 2nd player.

What do you think about the final GQ4? Compare it to older Gold Quest games!

Well... Gold Quest 4 definitely joins the same scale of addiction as the first three parts of the tetralogy. In comparison to older parts a lot has happened concerning the graphics and the level design. I also think that the difficulty level compared to GQ3 is a bit easier.

How did you like working in the team? Do you often test games?

The teamwork was fabulous. It was a great team. I already worked on several games myself together with a friend and also tested them.

With issue 7 we celebrate one year of the SCACOM-Aktuell. What do you think of our "new" magazine? What would you change and what do you like best?

I think the magazine has an enjoyable variety in the different systems. A change which probably some people would like to have is the reduction of errors.

Do you think this magazine was mainly a good or a needless idea? Where do you see the difference to other existing magazines as e.g. Lotek?

I think the magazine was a good idea. After all it already differs to Lotek in the publication frequency. Also one can

find topics in your mag, which cannot be found in the Lotek.

We had/have a 264s special edition about the C16 and Plus/4... What do you think about these computers? (How did you like this edition?)

I think that also 264s have their charme (otherwise I wouldn't have a C16 standing around here).

What desires or projects do you have for the future?

My biggest wish is, that you still hear something about the C64 in 25 years. I am still working on some projects. Amongst others there is supposed to evolve a film synchro and I will busily go on composing my music project.

Do you want to get rid of something else?

I thank you for the honour the get interviewed. This doesn't happen every day *grin*. Else I would like to say hello to everyone who knows me and I wish you good luck with your project!

Thank you very much, we will take your advice to heart an try to minimise mistakes!

Links:

www.cevi-aktuell.de.vu

SCACOM-Disk

Stefan Egger

In this issue there is a special SCACOM Disk about "Gold Quest 4". Articles and interview about the game in last issue

In this issue there is a C64-disk included. There are two D64 images for two sides of the disk. Everybody can start the game with an Emulator like WinVICE or CCS64 because no Copyrighted files are needed.

Side A:

On this image there is a special version of Gold Quest 4 included. This is a special SCACOM version of the game with a lot of changes to other version. The changes in detail:

- different music
- 2 player mode
- different title screen
- Highscore Saver

Side B:

Also there comes a "Gold Quest 4 BETA" in the SCACOM version. You can play exclusively all four level in its first Beta-stage. Explore all the mistakes and be a Beta-tester.

We hope you enjoy this special SCACOM disk on emulator or your real C64!

At the end of this issue there is a spezial 5,25" Cover for Nhyaaaa! 11. So your SCACOM Disk is protected.

Also there is a sticker for the Diskette:



C64 Wiki

Bubble Bobble

Source: www.c64-wiki.com

Description

You and optionally one of your friends play Bub and Bob, two brontosaurus. By spitting bubbles you can trap your enemies into them. The next step is to touch or jump on these bubbles to make them burst. When all monsters are defeated, you can go on to the next level. After a certain amount of time, a special enemy called "Baron Blubba" appears, if not all the other enemies are already caught. Be aware of him.

Controls

- Joystick left/right: move left or right
- Joystick oben: jump
- Joystick oben+rechts: jump to the right
- Joystick oben+links: jump to the left
- Button: spit bubbles

Design

A 2D-screen per level with tiny sprites and a background tune. Almost equivalent to the same named arcade classic.

Hints

- If collected E,X,T,E,N,D, you skip the level and get an extra live
- Extra lives reaching 30.000 - 100.000 - 400.000 - 1.000.000 and 2.000.000 points
- When both players take a power up the same time, both get its powers

- By collecting the umbrella you can skip 3 or even 7 levels
- Some levels require to jump higher than normal. In multiplayer mode, one player has to spit bubbles while the other player jumps on them (jump on the bubble and then directly on the higher spot or else the bubble will burst). This is more difficult in singleplayer mode.





Cheats

To challenge other enemies

who shoot fire balls, press the following keys when the title screen appears: [S] [U] [P] [O] [R] [commodore key]. If the side of the screen turns red for a short period of time, start the game.

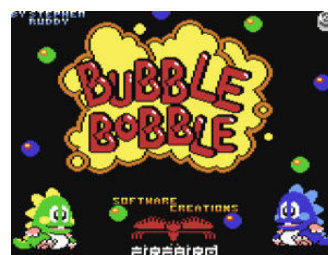
There's a trainer version of the game on Remember (Release 161). It includes different training modes.



Name	Bobble Bubble
Developer	Stephen Ruddy
Company	Software Creations / Firebird
Publisher	Firebird
Musician	Peter Clarke
HVSC-File	/Clarke_Peter/Bubble_Bobble.sid
Release	1987
Platform	Amiga, Apple II, Arcade, Atari ST, C64, Game Boy, Game Boy Advance, Game Gear, MSX, NES, PC-DOS, Playstation, Saturn
Genre	Arcade, Platformer
Gamemode	1 - 2 Multiplayer
Operation	
Media	
Language	English
Information	Sequel: Rainbow Islands



Games Convention 2008

Stefan Egger

At the Games Convention 2008 in Leipzig/Germany there were also old computers! You could try arcade-machines as well as a lot of popular old consoles and computer systems. Of course, all historical relevant computer platforms and exots like the Vectrex of 1982.

It was very interesting because a lot of young people were playing with old computers. But no matter whether you're young or old, everyone had fun. The number of visitors was significant.

Here are a few impressions and photos:





pictures © 2008: Flickr-User: kielerkai, Xboxhome und mr93 - Youtube.User: derNico86

Commodores Patents

Stefan Egger

A little insight into the patents of Commodore and Amiga.

Jay G. Miner has a patent called "video game and personal computer" submitted. Further information:

Patent number: 4777621
 Filing date: Jul 19, 1985
 Issue date: Oct 11, 1988
 Inventors: Jay G. Miner, Joseph C. Decuir, Ronald H. Nicholson
 Assignees: Commodore-Amiga, Inc.
 Primary Examiner: John G. Mills

A short summary:

„A video game home computer is implemented in NMOS (n type metal oxide semiconductor) technology with plural microprocessors. Centralized bus architecture and direct memory access (DMA) techniques are employed. A video display generator provides color signal outputs to drive a commercial television receiver display. This display generator receives inputs from both microprocessors and obtains data directly from memory. A bit map of display information is kept in memory, wherein bits of information in memory image the precise screen display for each instance in time. A bit map manipulator circuit performs, under microprocessor direction, logic function manipulation of the bit map

data. Access between system components is accomplished via the bus architecture on a priority queue basis. Chip count and chip area is minimized.“

There are detailed descriptions, technical drawings and other complicated technical component descriptions, which I will not argue.

Here is a patent which should protect the case designs for a Commodore printer. The patent had a period of 14 years...

Filing date: Apr 4, 1983
Issue date: Nov 26, 1985

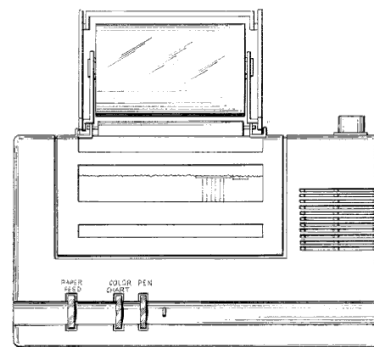
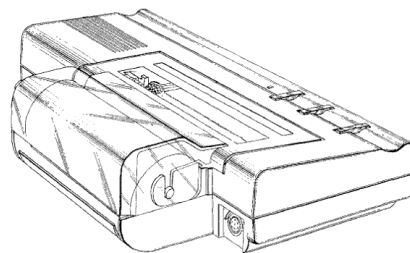

Even the cartridge casing of the C64 was patented.

Filing date: Apr 4, 1983
Issue date: Aug 27, 1985

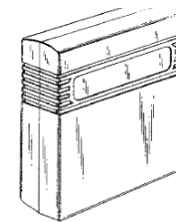

FIG. 1.

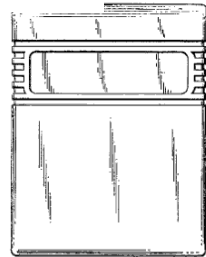
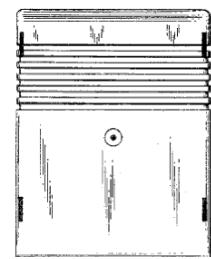
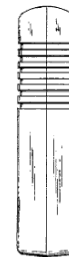
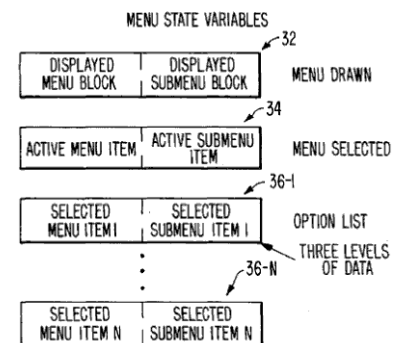

FIG. 2.



Even the Amiga menu system is patented (Jul 18, 1986)

FIG. 3.



In Figure 3, the exact menu structure in Figure 4 the entire surface.

FIG. 4.

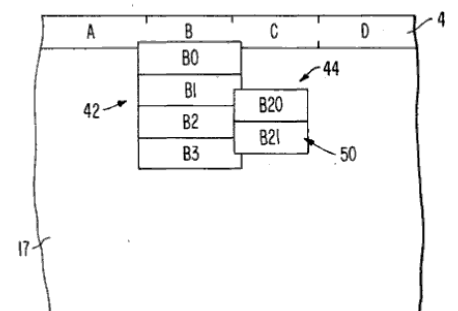

Manufacturers also discovered the Commodore computers. There is a patent on a piano keyboard for the C64...

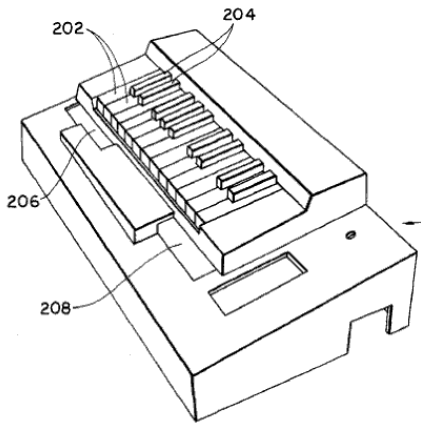

... and an information terminal that uses the Amiga technology (Amiga in red circle):

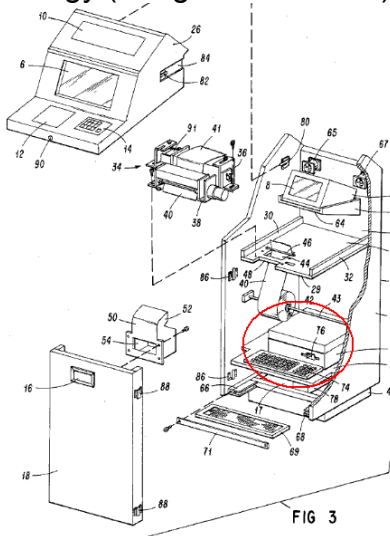

Here are a few more patents where cases as drawings can be seen!

Commodore CBM 610:
Patent number: D277755
Filing date: Aug 27, 1982
Issue date: Feb 26, 1985

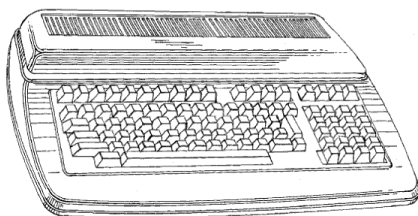

Here is the CBM 720, designed by Porsche:
Patent number: D277755
Filing date: Aug 27, 1982
Issue date: Feb 26, 1985

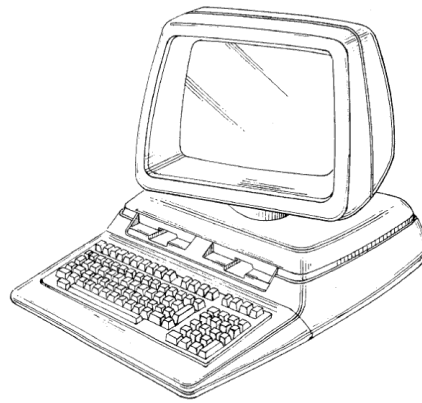

U.S. Patent Mar. 5, 1985 Sheet 2 of 3 Des. 277,857

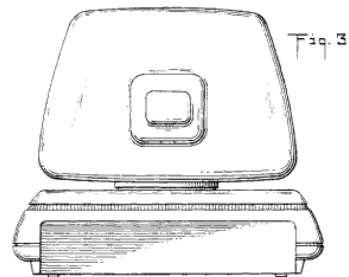
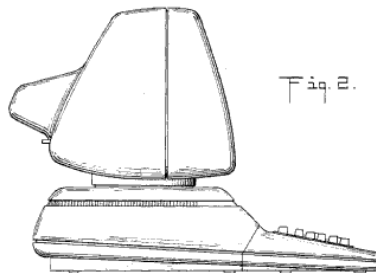

CD32 game console:
Patent number: D356835
Filing date: Jul 23, 1993
Issue date: Mar 28, 1995:

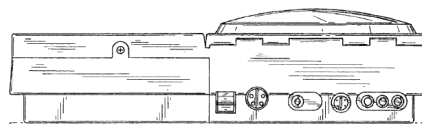
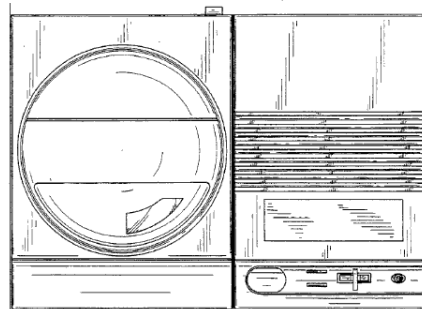

Even the VC10/Max Machine / Ultimax called computer, which appeared in Japan, was established on Aug 27, 1982 as a patent. It is thought

that he appeared only in Japan. Here's a page of the patent with different views of this rare Computers:

U.S. Patent Mar. 5, 1985 Des. 277,855

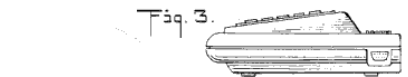
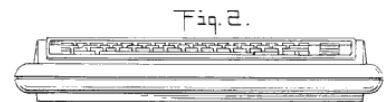
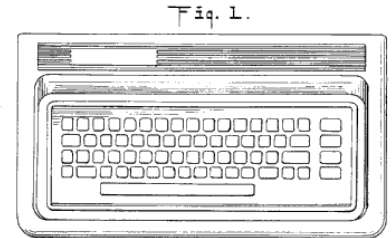

And an old Commodore typewriter of 1968:

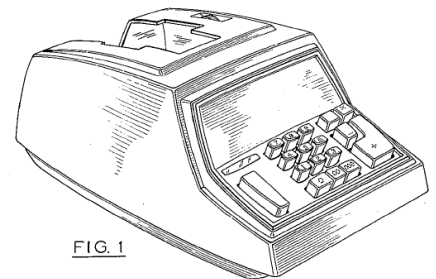

FIG. 1

I hope that this little insight into the patent world succeeded. Other patents of Commodore or other companies can link in their search.

Source and further patent search:

www.google.com/patents

The Innovative Museum

Stefan Egger

Why I've made it

I had a good idea for a modern museum and I collect Commodore Computers. But it's very sad that there are very few museums that focus on Computer History.

The idea

Museums should be more attractive to disabled people and children. There are a lot of museums in the whole world but very few of them are really modern or are adapted to the needs of the disabled. I think that there should be no steps and big places that people with wheelchairs can access it easily. Also there should be modern information touch screens. So the user can easily access a lot of information in several different languages, pictures and even 3D models! The museum can easily update the information, with no costs and low effort. For handicapped people and also for children (e.g. school classes) there are extra screens and with switches you can lower the showcase.

With Bentley's MicroStation you can see the room before it has been built. Therefore little problems can be solved beforehand and the desires of the orderer can be considered during the design process. So I designed all those things in real size. This workflow can help to decrease the cost and it's very fast.

My project

The project's name is "THE INNOVATIV MUSEUM". I've chosen this name because it's a totally new concept and all displayed items are very detailed and accurately because I own Commodore accessory (each displayed item was time-consuming with up to hours of work). Because of these details it takes effect very real.

It is one room to show the concept - in a museum there could be more similar rooms put together or other displayed items. It's a very safe place for the displayed objects and it's also imaginable to have different temperature for objects and the rest of the room (for preservation purposes).

The details

- Big room with a tinted window for sunlight
- Touch-Screens with pictures of the displayed items (pictures are rendered in MicroStation as well as composed in other graphic-programs).
- Modern showcases with lighting (lowered on side of the Amiga)
- Logos of the Computer-firms for more oversight
- Seven old advertising behind picture frames (glass with little holders)
- 19 Original Displayed items (11 different shapes)
- All models accurate and with scans or photos of all Logos

and stickers (from Original Hardware)

- Difficult rendering because of the Lighting and the Glass
- RPC People (free or demo content) and one RPC Plant for more realism
- Doors for changing the Items or repair the mechanism to lower the showcase

You can check yourself the exactness of the models if you search the web for pictures of Commodore Hardware!

The objects

Commodore:

- 1541 white
- 1541 brown
- 1541-II
- 1571
- 3 Datasets
- C64 DTV
- Diskettes 5.25"
- 2 Mousepads

Amiga:

- Competition Pro Joystick
- Mouse
- Commodore-Quartett (SCACOM)
- A 1011
- A 1411
- Diskettes 3.5"
- 2 Mousepads

Link:

<http://scacom.kilu.de/museum.html>



Idea and pictures © Stefan Egger

Feedback

Apache2k

As good as the 2nd issue.
Thumbs up!

Richard/TND

I'm reading the Nyaaaaah! article. The interview with Thorsten and also Baracuda's articles were great. Good read. I enjoyed it! My guess is that the sprite for C64 is from Chuckie Egg. Am I right?

Sledge

Hi Stefan,

is nice to read my german interview with you in english. Many thanks to Cami for the translation.

StarLab

Loved it!!

Especially enjoyed the article on Bill Gates.

I made mention of it on a webmaster forum with a link to your site. Not sure if that will do anything for the popularity of the Magazine, but it will give you a strong backlink to your site, if nothing else.

I will check out the older issues shortly.

Thanks...

Baracudas story

Baracuda

Baracuda talks about the Emsdetten Party in Germany (7th to 8th October 1995)

The Emsdetten Party 1995 should be a Big Event but Glare had a handicap at that time.

So he cancelled the planed competitions with other groups.

We in Smash Designs and some other guys thought that it was no matter not to visit him at home after he left the hospital.

So we drove at a weekend to his house by car. After a while we reached Emsdetten.

Emsdetten is a scene-city... Szeners know what i mean. :)

We arrive at the evening and after we had some fun in the car together. Asking people and some cows if they could tell us the right way to glares house ? .. ;)

Too bad that AEG couldn't mess with other releases and other groups at that time.

But our Flatline.PRIV we released rocks the masses..

Our 2 previews V1+V2 looks a bit different to the Final Version.

The PC lamers from the neighborhood there were the losers of the day, hehe...

I spread the SDS Tools - a Toolcollection done by myself only with Tools by Smash Designs Coders (DCP, AEG, BAD, Titan) done on: 28.06.1995 with an infonote about.

I helped Glare & Tale to type the English text for their mags (DA CAPO and a mental mag can't remember the name yet..)

So AEG helped them to code the Intro and Main Stuff. Won't forget our fans on that evening, hehe..

DA CAPO is still in my Diskbox and no one saw this mag.. ? Can't believe that but it seems true..

Sources:

Text by Baracuda/SMASH-DS/BLAZON/CRYPT/THE STOCK

Party Reports:

@Glare's Place (the cancelled Party)

Organizers:

Glare

Date:

7 - 8 October 1995

Place:

Emsdetten
Germany

Event Types:

Copy Party, Demo Party, Meeting, Standalone Compo

Attendants : (6)

Ace, AEG, Baracuda, Glare, Nasty Boy, Tale

Productions released outside compos:

Basic Demo by Smash Designs (One-File Demo)

About SCACOM

English SCACOM supported the C64-Wiki (www.c64-wiki.com). Have a look at our C64-wiki page where you can read some of our articles and interviews from SCACOM:

<http://www.c64-wiki.com/index.php/SCACOM>

Our magazines' homepage www.english-scacom.de.vu will remain online for the next time. But there will be no further Updates.

Again: Thanks to all fans and supportes!

Best C64 Game List - Part 2

Christophe Kohler

Here is the second and last part of the best C64 Games that were ported from other Systems!

After some research (and help from the guys of lemon64, thanks), here is THE BEST C64 GAMES LIST. This is the first part of it (part two will be in the next issue).

Ghost'n'Goblins (Arcade)



Green Beret (Arcade)



H.E.R.O. (Atari 1984)



Jumpman (Atari)

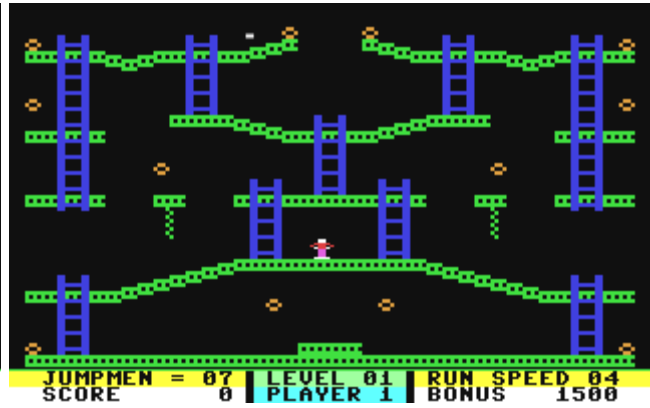

Matrix (VC 20)

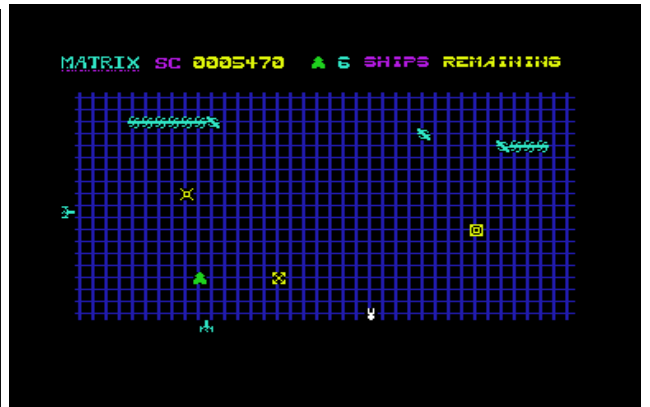

Mercenary (Atari)



Montezuma's Revenge (Atari)



MULE (Atari)

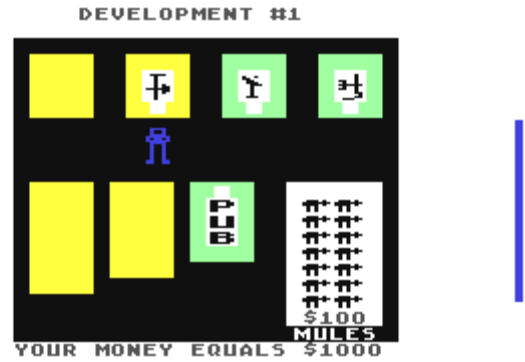

Rally Speedway (Atari)



Spelunker (Atari)



Spy vs Spy serie (Atari)



Wizard of Wor (Arcade)



Disk-cover for „Gold Quest 4“



System: C64
 a game by INFERIOR
 www.inferior-c64.de.vu
 Cover-Design by Telespielator

You can play all four level in its first Beta-stage. Explore all mistakes and be a Beta-tester.



Side B : Gold Quest BETA

This is a special SCACOM version of the game with a lot of changes to other version.



Side A: Gold Quest 4



Word search

In the puzzle there are 14 words on the topic of "C64 games" hidden

F T Q H E T N M U I D I R U I J X T
 Z R Z H T U R R I C A N H Q E X S A
 T F Y Q U U E U F C I N K N L W W J
 G K M Y I D S R N H P J G X I P V G
 L G F O N E O N A M P M U J T I J X
 C G M E T G X M G H K K L W E F S U
 R G F A G L L A B D E E P S N B Y Q
 P E R E A K L C K S I K A T A K O P
 D I R N S S R W I B C Z J R X Q B I
 P N A C N P P A R A D R O I D Q R T
 A I Q G I A H S K V D B A T K K E S
 G T W A B N D W C O P Z P E K S D T
 J Y D U V Y E H T O U F S I K H N O
 O H S N Q Z H M B E A T H G U C O P
 F G G T U X C P I T F A L L W Z W H
 P I T L S O C C E R M A S T E R B Q
 O T Y E U Y N L Z B A R K A N O I D
 H Z X T J I O R S W X L P A C M A N

- Arkanoid
- Defender
- Elite
- Frogger
- Gauntlet
- Giana
- Jumpman
- Katakis
- Krakout
- Pacman
- Paradroid
- Pirates
- Pitfall
- Pitstop
- Soccermaster
- Speedball
- Turrican
- Uridium
- Wonderboy
- Zynaps

Right there are all words that are hidden in the letter soup above.

The words can be hidden in directions, (vertically, horizontally and diagonally, and in two possible reading directions). It is recommended print this page!

In the next issue there is the solution of the puzzle!

W P X Z W S E O T E S S W X
 U O R O Q V G Z F U D I U A
 T C S O B L B T I Z F A T X
 Q L B T T I T M R X K Z R Y
 G P H C H O H W A E S N I Y
 M A P R X G V T K F E O A R
 C R R Y X X I I I E D B D A
 R A P P Z X R L S F G J D D
 E M N T S G R G R I D S N W
 S O W Q W Q S B I O N O A
 T U R I P R M P H A A N I R
 B N Y Q Y A H K N N Y F R D
 W T X Y S I Q E B W M O O E
 F W O H E N A T O P A D U A

Solution from issue 3 "C64 Demo Scene":

Comic



Game Show

1 games are those graphics? Solution in next issue!



C64



Amiga

Solution of last issue:
C64: Chuckie Egg, Amiga: Test Drive 2



10 reasons . . .

... to own a Amiga:

- 1) Because they were ahead of the time: 4096 Colors since 1985
- 2) If you can simply turn off the computer
- 3) Because you can run the best demos from the scene
- 4) Because even after over 20 years old games can be funny
- 5) Because today you can start all your favorite games with WHDLoad quickly from hard disk!
- 6) From Original A500 up to the professional A4000T - an Amiga is always fun!
- 7.) Minimig: Portable and small Amiga
- 8) Because there will be more new WHD load slaves
- 9) USB on Amiga: Not all things will work but it is still cool!
- 10) Because all Amiga computer have a nice design



... to own a Commodore 64:

- 1) Because is a solution for all the problems
- 2) Because he is not the best, the fastest and most beautiful computer but the only one with a "heart"
- 3) Because of the blinking cursor and the friendly "Ready"
- 4) Because there are a lot of texts about him in our favorite magazines ...
- 5) Because you never can play all the games. There are simply too many!
- 6.) 1541 Ultimate - Good hardware for good computers!
- 7.) Netracer - Network games on the C64!
- 8) Very robust
- 9) Lot of Multiplayer-games: Who is the "Decathlon" Champion?
- 10.) 22 million people can not be wrong!



Some final pictures



Commodore was a Technology-company. That was really true what the advertising promises. Topics such as the PC division, Multimedia CDTV console, UNIX on the A3000 and the Commodore logo are represented as buildings. That looks cool!

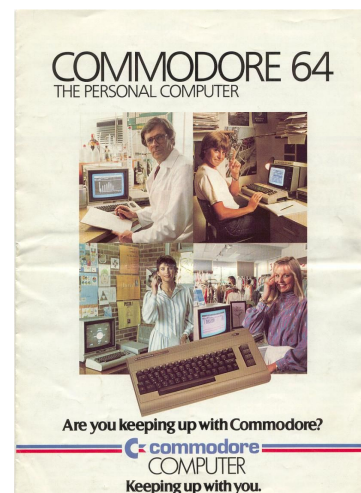

Are you keeping up with Commodore? In addition to a song and the poster above, there are also embarrassing TV commercials: There you can see that all Commodore owners greet themselves with a stupid gesture.