



XR-2943

Fax/Data Microcontroller with V.42bis

T-75-33-90

GENERAL DESCRIPTION

The XR-2943 is a dedicated microcontroller that provides command control for the XR-2900 Fax/Data modem chip set. The XR-2943 provides control for CCITT recommended V.42 error detection, including LAPM and MNP 2-4 protocols, with V.42bis BTLZ / MNP 5 data compression. Also supported is the Class 2 (EIA PN 2388) standard 'AT+F' extended command set.

The system architecture of the XR-2943 allows the actual command sets for the 'AT', 'AT+F', MNP, and LAPM and V.42 bis to reside external to the XR-2943, allowing ease of customization. Exar provides these command sets to use as is, or the designer can modify to the requirements of the design.

The XR-2943 operates from a single +5 volt power supply, offering low power consumption through CMOS technology.

FEATURES *

Group 3 Send/Receive Fax
Compatibility with Available Applications Software
Error Free Data Transfer:

DATA Mode

- LAPM
- MNP 2-4

MNP Class 5 Data Compression
•4800 BPS Throughput

Increased Data Throughput by V.42bis Data Compression

- 9600 BPS Throughput

'AT' Command Control

EIA PN 2388 (CL2) Standard Commands ('AT+F')

- Easily Modified, Exar Supplied
- 'AT'/AT+F/MNP/V.42/V.42bis

*(Apply when used with XR-2900 Fax/Data modem chip set)

APPLICATIONS

Error Free Fax/Data Modem Applications
Stand-Alone Fax/Data Modems
Smart Modems
Laptop Modems (Send and Receive Fax or Data)
Networked Fax Machines

PIN ASSIGNMENT

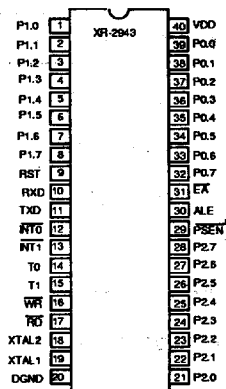

(See back pages for PLCC and QFP packages)

3

ORDERING INFORMATION

Part Number	Package	Operating Temp.
XR-2943CP	40 Pin Plastic Dip	0°C to 70°C
XR-2943CJ	44 Pin PLCC	0°C to 70°C
XR-2943CQ	44 Pin QFP	0°C to 70°C

ABSOLUTE MAXIMUM RATINGS

Power Supply	-0.3V to + 7V
Input Voltage	-0.7V to (VDD +0.3V)
DC Input Current	±10mA
(any input)	
Power Dissipation (Package Limitation)	1W
Derate above 25°C	11 mW/°C
Storage Temperature Range	-65°C to +125°C

SYSTEM DESCRIPTION

The XR-2943, when coupled to the XR-2900 Fax/Data modem chip set, allows the implementation of a Group 3 fax/2400 BPS V.22bis modem. With MNP/ V.42/V.42bis operation included for data mode, compressed and error-free operation is provided.

The XR-2943 is just one in the family of controller options for the XR-2900 Fax/Data modem chip set, including:

FUNCTION	CONTROLLER
'AT' and 'AT+F'	8031
'AT'/AT+F/V.42/MNP 5	XR-2942
'AT'/AT+F/V.42/V.42bis/MNP 5	XR-2943

XR-2943

T-75-33-90

ELECTRICAL CHARACTERISTICSTest Conditions: $T_A = 25^\circ\text{C}$, $V_{DD} = 5V \pm 10\%$, $F_{CLK} = 11.0592\text{MHz} \pm 0.05\%$, unless otherwise specified.

SYMBOL	PARAMETERS	MIN	TYP	MAX	UNITS	CONDITIONS
V_{DD}	Power Supply Voltage	4.5	5	5.5	V	
I_{DD}	Power Supply Current		18	22	mA	
V_{IH}	Input High Voltage	1.8			V	Except XTAL1 and RST
V_{IH}	Input High Voltage	3.5			V	XTAL 1 and RST
V_{OH}	Output High Voltage	2.4			V	Ports 1,2,3 $I_{OH} = -60\mu\text{A}$
V_{OH}	Output High Voltage	2.4			V	Port 0 (External Bus Mode) ALE, PSEN $I_{OH} = -400\mu\text{A}$
V_{OL}	Output Low Voltage			0.45	V	Ports 1,2,3, $I_{OL} = 1.6\text{ mA}$
V_{OL}	Output Low Voltage			0.45	V	Port 0, ALE, PSEN $I_{OL} = 3.2\text{ mA}$
I_{IH}	Input High Current (Leakage)			± 10	μA	$0.45 \leq V_I \leq V_{DD}$
I_{IL}	Input Low Current			-50	μA	$V_{IN} = 0.45V$

XR-2943

T-75-33-90

SYSTEM OPERATION

A typical application utilizing the XR-2943 to support the XR-2900 Fax/Data chip set, is shown in Figure 1. The XR-2900 provides the complete modem data pump function for:

CCITT	V.29	9600, 7200 BPS and 4800BPS
	V.27ter	4800 and 2400 BPS
	V.22bis	2400 BPS
	V.22	1200 BPS
	V.23(mode 2)	1200 / 75 BPS
	V.21(Ch 2)	300 BPS
Bell	212A	1200 BPS
	103	300 BPS

Command control is supported by the XR-2943 for:

MNP 2-4	Microcom Error Correction
MNP 5	Microcom Data Compression
LAPM	CCITT Recommended V.42 Error Correction
BT LZ	British Telecom Lempel Ziv (V.42bis)
'AT'	Industry Standard 'AT' Commands
'AT+F'	EIA2388(CL2) Fax Commands

Although the XR-2943 does provide complete command control, the actual commands for the various modes reside in an external 32k Bytes EPROM. With this architecture and an Exar supplied command set, maximum flexibility is offered. The command set can be used as is, or customer tailored to a particular design.

The unique architecture utilized by the XR-2900 and command controller allow the same hardware (Printed Circuit Board (PCB)) to support several different types of Fax/Data modems. By changing available pin-to-pin compatible microcontrollers, the Fax/Data modem types listed in Table 1 are all possible with the same printed circuit board. As mode types are changed by the μ C, EPROM supported command sets and SRAM size change and/or elimination are also required. In each case Exar provides complete production worthy command sets which may be used as is, or easily modified to meet specific application requirements. To aid in software modifications, Tables 2, 3 and 4 list the XR-2943 memory mapping, indicating customer usable regions.

External memory modifications requiring μ C (XR-2943) support will need entry/re-entry point information. This point is important as the XR-2943 contains program memory with Exar proprietary V.42/MNP5/Auto Fax/Data Select functions not accessible externally (fusible link protected) or available to Exar customers. The V.42bis algorithm is located in external EPROM, however, source code is not provided for this routine.

2400 BPS Data Mode	Microcontroller Part Number	External Memory Requirements (Bytes)	
		EPROM	SRAM
'AT'	8031 (Generic ROMLESS μ P)	32k	8k/32k
'AT' / MNP5/V.42	XR-2942	32K	8K/32K
'AT'/MNP5/V.42/ V.42bis	XR-2943	32K	32K

Table 1. 2900 BPS Modem Options / μ C, EPROM, RAM Requirements

XR-2943

T-75-33-90

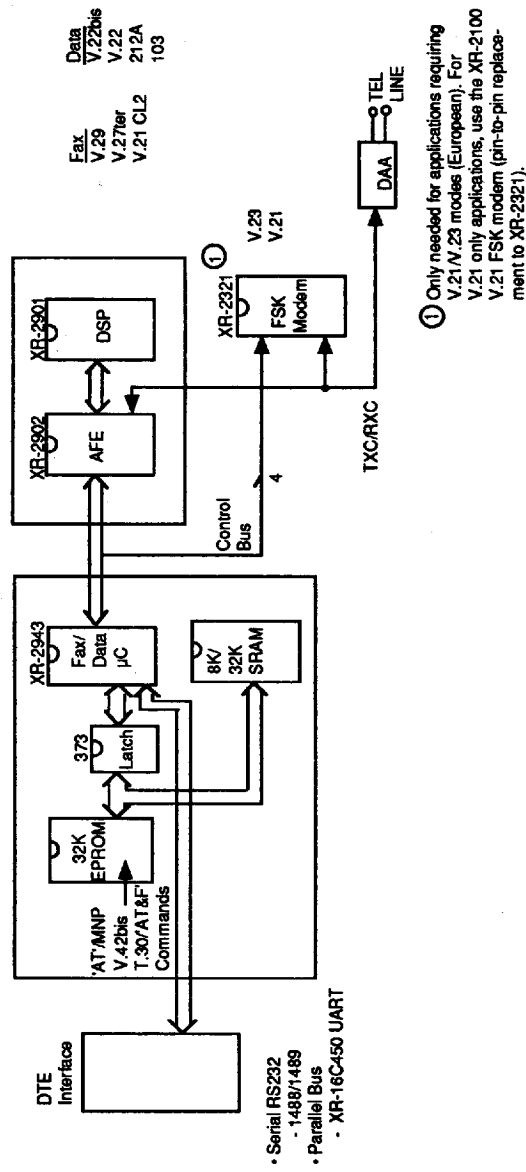

Figure 1. Fax/Data Modem with V.42bis/MNP5 (Data Mode) Block Diagram

XR-2943

T-75-33-90

ENTRY POINTS AND MEMORY MAPPING

Status / Mode Setting	Memory Locations	Description
Status	Location	Description
SPD_FLG	20 H.7	Speed Conversion Enable Flag.
BK_PRE	51 H	Break Prescaler Timer
BK_TMR	52 H	Break Timer (Only in Normal Mode)
MRCVP2	803BH	Disconnect to Check Auto-Reliable Fallback Mode.
PASS_B	9D14H	Escape Code Checking Byte in Speed Conversion Mode.
SPEED	9D15H	Speed Indicator For All Modes. 0-19200 BPS 1 - 9600 BPS 2 - 4800 BPS 3- 2400 BPS 4 - 1200 BPS 5 - 300 BPS
Z_BUF	9D16H	Auto Reliable Fallback Character.
BACK_RAM	9D1AH	Starting Address for Command Buffer Backup.
OPT_P	9D50H	Output Port Selection Option (FOFF H to 40 FFH). This Parameter is Initialized Immediately After Power On and constantly monitored by MNP Module.
MNP_S	9E22H	Reliable Link Indicator
RETRAN	24H.0	RETRANSMISSION

Function Call Locations - V.42bis/V.42/ MNP 5 Program Entry Points

Function	Location	Description
SCTINT_1	0006H	Interrupt 0 Jump-In Point.
SCRINT_1	0016H	Interrupt 1 Jump-In Point.
SPINT_1	0026H	Serial Port Interrupt Jump-In Point.
MSG_CP	0030H	Exar Copyright Message.
P_ECRAM_1	0060H	After Escape MNP Re-Entry Point.
MSG_CPY	0063H	Exar Copyright Calling Subroutine.
MNP_IN	0066H	MNP Program Immediate Re-Entry Point for modifying MNP Program.
SPD_INM	0069H	Speed Conversion Program Jump-In Point.
INI_SPDM	006CH	Speed Conversion Initialization Routine.

V21_IN_1	006FH	300 BPS Speed Conversion Timer SetUp.
EC_MAIN	0080H	Calling Main MNP Program. This is the only location which will initiate the MNP program.

XR-2943 Re-Entry Points

Function	Location	Description
PWR_ONS	C000H	Power On
OUT_SCT	C003H	Interrupt 0
OUT_T0	C006H	Timer 0
OUT_SCR	C009H	Interrupt 1
OUT_T1	C00CH	Timer 1
OUT_SP	C00FH	Serial Port Interrupt
OUT_T2	C012H	Timer 2
MNP_OUT	C015H	MNP Program Intermediate Point
CHK070S	C01BH	MNP 'ESC' Jump Out Point
DISCONNECT	C01EH	MNP Disconnect
ON_LOOPS	C021H	Auto-Reliable Fallback Point.
SPD_OUTS	C024H	Speed Conversion Jump Out Point.
V21_INS	C027H	Call Speed Conversion ASM for 300 BPS.
SPD_TXD	C02AH	Put TXDATA to Modem Chip.
SPD_RXD	C02DH	Get RXDATA From Modem Chip.
I_TXSYNTTQ	C030H	GET TX CRC-CCITT CALCULATION ROUTINE
I_RXSYNTT	C033H	GET RX CRC-16 CALCULATION ROUTINE
I_TXASYN16	C036H	GET TX CRC-16 CALCULATION ROUTINE
I_RXASYN16	C039H	GET RX CRC-16 CALCULATION ROUTINE
I_SNDREL	C03CH	GET SENDING RESULT CODE SUBROUTINE
I_MNPINIT	C03FH	MNP PARAMETER INITIALIZATION ROUTINE
I_V42INIT	C042H	V42 PARAMETER INITIALIZATION ROUTINE
I_SETURMNP	C045H	UART SETTING ROUTINE
I_ENCODE	C048H	BTLZ ENCODING ROTINE
I_DECODE	C04BH	BTLZ DECODING ROTINE
I_BTFLUSH	C04EH	BTLZ DATA FLUSHING ROUTINE
I_BTINIT	C051H	BTLZ COMPRESSION INITIALIZATION

3

XR-2943

T-75-33-90

RAM Locations

The stack in the 'AT' program starts from 0C0H on page 1 and occupies 64 bytes of space. Internal RAM on page 0 has 23 bytes and page 1, 64 bytes of free indicator space.

The external RAM data memory is as follows:

- | | |
|----------------------------|-------------|
| 1) Error Control | 8000H-8FFFH |
| 2) Data Compression Buffer | 9000H-93FFH |
| 3) FAX/Remote Access | 9400H-95FFH |
| 4) Available for use | 9600H-97FFH |
| 5) V.42/V.42 bis | 9800H-99FFH |
| 6) Break Buffer | 9A00H-9AFFH |
| 7) DTE TX Buffer | 9B00H-9BFFH |
| 8) DTE RX Buffer | 9C00H-9CFFH |

- | | |
|---------------------------------|-------------|
| 9) Misc. Registers | 9D00H-9DFFH |
| 10) MNP RAM Backup Buffer | 9E00H-9EFFH |
| 11) 'AT' RAM Backup Buffer | 9F00H-9FFFH |
| 12) BTLZ Compression Dictionary | C000H-FFFFH |

Note: Before jumping into the MNP program the control code will backup the entire 256 bytes of AT RAM into external RAM. In addition, before jumping out of the MNP program it will backup the entire 256 bytes of MNP RAM into external RAM.

The Miscellaneous register function list is provided below. The option code control allows the firmware engineer to change the factory defaults in source code, then reassemble.

OPTION	LOCATION	PARAMETER	COMMAND	DESCRIPTION
Opt_0	9D09H	0	\N0	Non-MNP
		1	\N2	Reliable Mode
		2*	\N3	Auto_Reliable Mode
Opt_1	9F0AH	0	\Q1	Normal XON/XOFF
		1		Not used
		5*	\Q2	Unidirectional RTS/CTS
		3	\X1	XON/XOFF Pass Through
		4	\Q4	XON/XOFF Send Only
		2	\Q3	Bidirectional RTS/CTS
Opt_2	9D0BH (BIT0)	0		Disable Speed Conversion
		1		Enable Speed Conversion
Opt_2	9D0BH (BIT1)	0	\J0	Disable Serial port rate adjust
		1*	\J1	Enable Serial port rate adjust
Opt_2	9D0BH (BIT2)	0*	\G0	Disable modem port flow control
		1	\G1	Enable modem port flow control to XON/XOFF (for Normal mode only)
Opt_2	9D0BH (BIT3)	0*	-P0	Parity bit for checking XON/XOFF
		1	-P1	Ignore parity bit checking for XON/XOFF
Opt_2	9D0BH (BIT4)	0*		Not used
		1		
Opt_2	9D0BH (BIT5)	0*		Not used
		1		

XR-2943

T-75-33-90

OPTION	LOCATION	PARAMETER	COMMAND	DESCRIPTION
Opt_2	9D0BH (BIT6)	0* 1	\M0 \M1	V.42 Mode MNP Mode
Opt_2	9D0BH (BIT7)	0 1*	%C0 %C1	Disable Data Compression Enable Data Compression
Opt_3	9D0CH	0 1 2 3*	\A0 \A1 \A2 \A3	Block size to transmit, 64bytes 128 bytes 192 bytes 256 bytes
Opt_4	9D0DH	0-9 3*	\Bn	Xmit break during normal mode at data mode, n=100ms
Opt_5	9D0EH	1 2 3*	\K1 \K3 \K5	Expedited, Destructive Expedited, Non-destructive Non-expedited, Non-destructive
Opt_6	9D12	(81H)	\O	Originate Reliable Link
Opt_6	9D12H	(82H)	\U	Accept Reliable
Opt_6	9D12H	(80H)	\Y	Switch to Reliable Link
Opt_7	9D13 (BIT0)	1 0		For 300 BPS connect indicator For other speed
Opt_8	9D0FH (BIT1,0)	0 1* 2 3	\V0 \V1 \V2 \V3	Standard Result code form Result code for MNP
Opt_8	9D0FH (BIT3,2)	0* 1 2	\C0 \C1 \C2	No set for Auto-reliable buffer Set Auto-reliable buffer Set fall back character
Opt_8	9D0FH (BIT4)	0 1*	\L0 \L1	MNP Stream mode MNP Block mode
Opt_8	9D0FH (BIT5)	0 1*	\Q0-\Q4 \Q5,\Q6	For \Q5, \Q6 turnoff CTS
Opt_8	9D0FH (BIT6)	0* 1		V.42 only negotiation
Opt_8	9D0FH (BIT7)	0* 1		Eliminate ODP for V.42
Opt_9	9D10H	0* N	%An	Auto-reliable fallback character

3

XR-2943

T-75-33-90

OPTION	LOCATION	PARAMETER	COMMAND	DESCRIPTION
Opt_A	9D11H	0* N	\Tn	Inactivity Timer
Opt_B	9D51H (BIT4)	0* 1	%Dn	Default Clear RX Buffer after disconnect
Opt_C	9D52H	6-250 32*	S90	Maximum String Length (BTLZ) character
Opt_D	9D53H (BOIT1,0)	0 1 2 3*		Disable BTLZ Compression Enable BTLZ one-way encode only Enable BTLZ one-way decode only Enable BTLZ two-way compression
Opt_D	9D53H (BIT1,0)	0 1 2* 3		Dictionary size option-512 entry 1024 (1K) entries 2048 (2K) entries 4048 (1K) entries
Opt_E	9D56H			

XR-2943

T-75-33-90

Interrupt Vectors

The XR-2943 brings out all interrupt vectors to the external program. This allows easy customer modification of service routines to suit a particular application. The interrupt vectors of the XR-2943 are as follows:

```

ORG 0
LJMP PWR_ONS; Jump to Power
           OnSet Up
           Routine

EXT_INT0:  ORG 3H           ; Interrupt 0 for
           SCT

SCTINT1:   LJMP OUT_SCT

T_INT0:    LJMP SCTINT
           ORG 0BH           ;Timer 0 Interrupt

EXT_INT1:  LJMP OUT_T0
           ORG 13H           ;Interrupt 1 for
           SCR

SCRINT_1:  LJMP OUT_SCR
           LJMP SCRINT
           ORG 1BH

T_INT1:    LJMP OUT_T1
           ORG 23H           ;Timer 1
           Interrupt

INT_SER:   LJMP OUT_SP           ;Serial Port Interrupt

```

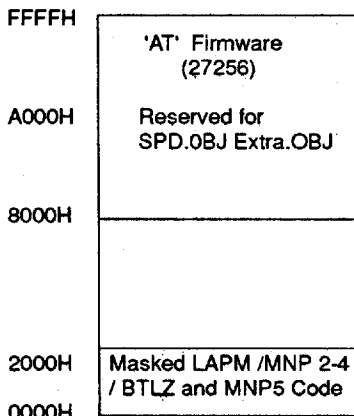

Note: 27256 = 32K Byte EPROM

Table 2. XR-2943 ROM Map

```

SPINT_1:  LJMP SPINT
           ORG 2BH

T_INT2:    LJMP OUT_T2           ;Timer 2 Interrupt

```

XR-2943 PROGRAM/DATA MEMORY MAPS

Tables 2, 3 and 4 show the ROM and RAM memory maps for XR-2943. It should be noted that without the use of separate CS (Chip Select) for the XR-2902 and the XR-2321, there would be an overlap of address locations.

As it is indicated in Table 2, 32K bytes of EPROM is assigned to 'AT' command firmware. This section of the ROM is located between 8000H and FFFFH.

BTLZ, LAPM, MNP 2-4 and MNP 5 code is masked in the microcontroller (XR-2943), and resides in the 8K bytes of memory, between address locations 0000H and IFFFH.

Table 3 shows the RAM map, in which the space between 0000H and 002CH address locations is used for modem chip address. Table 4 shows the modem chip (XR-2902) address assignment. Included is addressing for the XR-2321 and XR-2100. These chips are optional to the system design, but may be added where V.21 or V.23/V.21 standards are required. The XR-2321 provides both V.23 and V.21 FSK data standards, while the XR-2100 provides only V.21. See XR-2321 or XR-2100 datasheets for details.

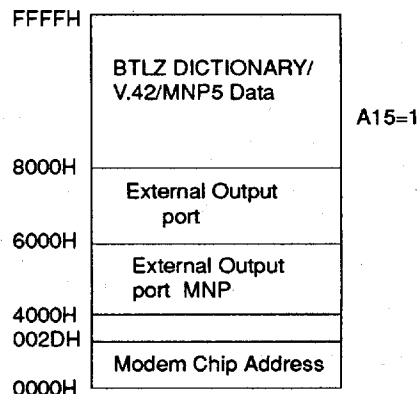

Table 3. XR-2943 RAM Map

XR-2943

T-75-33-90

MODEM CHIP	RAM ADDRESS	\overline{CS}
XR-2902	0000H - 001FH	A15=0 and A5 = 0
XR-2321	0028H - 002CH	A5=1 and A15=0
XR-2100	0028H - 0029H	A5=1 and A15 =0

Table 4. Modem Chip Address

Also RAM space between 8000H and FFFFH is assigned for the V.42bis dictionary, and MNP5 data and fax data. RAM locations between 4000H and 7FFFH are available for I/O ports such as LED, EIA, etc.

V.42 / MNP OPERATION

The XR-2943 when coupled with the XR-2900 Fax/Data modem chip set allows the implementation of a group 3 fax and an **error-free, increased throughput** 2400 BPS data modem. To gain an understanding of V.42bis/V.42/MNP 5 modes for data operation, the following basic information has been included. A basic understanding of error correction techniques, flow control, speed buffering, and data compression will allow the designer to better understand a V.42/MNP5/V.42bis modems capabilities and how to best utilize them. One excellent introductory book on the subject of data compression for both fax and data modes is DATA COMPRESSION by Gilbert Held. The publisher is WILEY.

V.42 is a CCITT recommended error correction protocol which allows asynchronous DTE's (Data Terminal Equipment) to communicate error-free with other such equipped modems.

The actual error detection protocol used in V.42 is an HDLC (High-level Data Link Control) based protocol called LAPM, for **Link Access Procedure for Modems**. For additional detailed information beyond the following basic description, refer to the CCITT Recommendations, Series V, 'Data Communication Over the Telephone Network'. The latest version is known as the '**Blue Book**' (Blue Covers) or Series, dated 1988 (Melbourne), a recent update from the '**Red Book**'.

V.42 Basic Operation/Features

- HDLC-based error correction protocol-LAPM
- Asynchronous (Async or 'start/stop') DTE Communication - error free

- Actual line transmission is synchronous (sync)- no start or stop bits (stripped from data), however initial handshake, subsequent to modem handshake is asynchronous
- Error Detection
 - Data sent in 'frames' or blocks with a nominal size (default) of 128 Octets (Octet - 8 bit) data frames.
 - Start/Stop bit elimination from data creates an actual data throughput improvement, roughly 120% of nominal. 2400 BPS becomes about 2900 BPS.
 - Encoded information added to data frame for receiver to 'decode' and determine if the block was error free. 16-bit cyclic redundancy check (CRC) methods are used for data encoded information to:
 - (1) indicate correct data and (2) recognize imperfect data frame.
 - Retransmission (automatic) of determined imperfect frames to ensure perfect data is received.

V.42/ V.42bis operation is found to be virtually identical (specifically to variable parameters) to that of MNP reliable / normal modes of operation. For this reason the MNP command set is also used for V.42/V.42bis variables control.

DATA COMPRESSION

Two general families exist of data compression techniques. The first is logical compression, which is limited to a defined file type. It is called logical because fixed defined paths exist for the compression and decompression; e.g. year, month, date, or the type of account: savings or checking. This technique would substitute a number 4 for April placing in 3 bits what would require 40 bits (7 bits and parity per character). To allow the inclusion of other months (above July, the seventh month) would require an additional bit, but the net number of bits being sent is reduced.

For compressing the type of account, a single bit would allow the encoding of either 'checking' or 'savings', rather than using the ASCII representation which would require up to 64 bits to transfer the two words. Both of these examples would require positioning limitations or the use of packets, where the location in the packet determines what logical decompression technique should be used to decode the information stored. This result is in an overhead of bits being needed to allow reliable decompression of the information.

The second technique is physical compression. This technique does not limit itself to certain types of information and files, but is more complicated to be implemented. Physical encoding compresses redundant characters substituting coded characters. As an extreme example, a page full of the letter 'a' could be sent as 'a5610', noting the fact that 5,610 'a's appear on the page. In this example the throughput would be 1122 times normal. Unfortunately, the situation to send such a large amount of compressed data does not occur too often. In addition to the encoded data, a start encoding symbol is needed to inform the decoder on the receiving side that the standard decoding technique should be used.

The two sub groups of physical compression is block encoding and stream encoding. Block encoding in general is a slower process, for it requires the entire file to be processed before sending. The use of stream encoding allows the mix of on-line information (entered by keyboard for example) and stored data. The default for the XR-2943 is stream mode. This is controlled by the \L command.

BTLZ[®] OPERATION

BTLZ is a patented technique to increase throughput to nearly 4 times an uncompressed file. To produce this greater performance BTLZ uses an adaptive dictionary that is partially reset from time to time to adapt to the possibly changing file. This 2-Dimensional dictionary allow for a greater compression ratio than the 1 Dimensional technique used by MNP[®] 5 which take ASCII codes and provide a shortened code.

The dictionary is created using data that is transmitted, therefore, no transmission time is needed to exchange dictionary data. The resetting, presetting or updating of the dictionary is under lock-step, where each deletion is predefined. Either a full reset to the first level occurs (most common letters and space character found in files), or removal of dead ends. This adaptive process provides two things. If not done, the dictionary would need to be infinite in size, for all possible data combinations (words) would have a path. In a repetitive data pattern situation this is ideal. For example, "THE QUICK BROWN FOX JUMPED OVER THE LAZY DOG" repeated over an over would be learned by the XR-2943 using BTLZ and compression would reach the maximum set between the DTE and DCE (19.2 KBPS). However, in a real life situation such files have limited usefulness. With a typical text file, random for the short term, the compression ratio is around 3.4:1.

It is this randomness that Mr. Jacob Ziv and Mr. Abraham Lempel based their compression theory upon. The idea that for short duration data transfer, a repetitive pattern can be seen, however for longer term data transfer, editing of the dictionary is needed. Their introductory paper: On the Complexity of Finite Sequences (IEEE Transactions on Information Theory, Volume IT-22 Number 1; January 1976; PP 75-81) goes into some detail as to how their compression technique was developed. This information is not needed to use the XR-2943.

British Telecom Lempel Ziv is a patented Data Compression technique used in the V.42bis standard.

MNP[®] OPERATION

MNP, or Microcom Networking Protocol was developed by Microcom, Inc., a modem manufacturer. Since conception, it has been in a constant state of update/improvement. For this reason 'classes' of operation emerged to signify each major update or improvement.

Relative to the V.22bis or 2400 BPS modems, up to class or level 5 has become the 'standard'. MNP is not used with the FAX modes of operation. As mentioned before HDLC framing techniques are used.

MNP CLASSES

(Throughput data is based on 2400 BPS line speed).

Class 1 A half duplex protocol and no included in many new designs. Throughput was about 70% or 1690 BPS. The XR-2943 does not support this class.

Class 2 Asynchronous operation with byte oriented data formatting. Throughput is roughly 84% of nominal or about 2000 BPS.

Class 3 Conversion to synchronous, bit oriented data handling is transmitted in blocks consisting of 1 to 64 characters. Throughput is about 108% or 2600 BPS.

Class 4 Basic characters are the same as Class 3, but block size is dynamic, up to 256 Bytes, (flexible size is based on data transmission quality). Throughput is 120% or 2900 BPS.

Class 5 Includes Class 3 and 4 with data compression techniques added. The compression effectiveness is dependent on the type of data, but typical throughput enhancements are up to 200% or 4800 BPS.

ERROR CORRECTION

Modem users have come to expect sophisticated circuitry like automatic adaptive equalization for varying phone characteristics and retrain modes for ensuring continued optimal performance. These techniques dramatically improve performance characteristics which is quantified by BER vs S/N measurements, the probability of errors when the modem signal is in the presence of noise.

The previously mentioned techniques are aimed at improving the modem data pump through analog (or digitally synthesized) circuitry. Techniques are becoming popular for not only improving, but virtually eliminating data errors through protocols implemented in the modem's command microcontroller (μ C). Prior to these 'hardware' based schemes, error correction provided in the applications software was available, such as X-MODEM or Kermit for asynchronous file transfer. In mainframe environments, SDLC or HDLC schemes were used.

Software based error correction schemes do however have their disadvantages. One important one being reduced data throughput. The throughput performance varies, but all schemes reduce data transfer below its nominal rate. Values of 30% are common, equating to only about 800 BPS for a 2400 BPS connection.

The hardware based error correction protocols supported by the XR-2943 for data mode are those as specified by the CCITT LAPM, and MNP. These schemes convert asynchronous data to be transmitted to a synchronous format (start and stop bits are stripped) for a packet-oriented protocol. Throughput values again vary, however typical values of 108% for the lower MNP Class 3 and 120% for MNP Class 4 or LAPM. These equate to roughly 2600 - 2900 BPS for 2400 BPS modems.

Actual error correction is based on adding information to the block-oriented data, through a 16-bit CRC (Cyclic Redundancy Check) calculation. The receiving side calculates CRC values for each block and if found to be incorrect, a retransmission of that block will be requested.

Typical frame sizes for LAPM are 128 Octets (8-bit start/stop bit stripped characters).

DETERMINATION OF BLOCK SIZE SETTING

The block size adjustment allows the user to compensate for situations where a high probability of errors exist. This condition occurs when the signal to noise ratio is extremely low. The XR-2900 provides performance curves for 2400 BPS (V.22bis) operation and single points BERT data for 1200 and 300 BPS. As a rule of thumb, under typical dial-up telephone connections, the negotiate block size feature of MNP and V.42 provides satisfactory results (generally 256 characters/block). However, if the signal to noise ratio is much less than 16dB S/N (at 2400 BPS) the probability of receiving data with an error is much greater, which would require retransmission of the entire block. By reducing the block size, the amount that is needed to be retransmitted is reduced, which increases the throughput. Under poor line conditions, the throughput would be reduced for a greater number of link acknowledgments would be needed.

XR-2943

T-75-33-90

For BTLZ 2 dimensional encoding, the maximum number of character setting (register S90) can help in obtaining a higher throughput earlier than if the straight learning mode of BTLZ is used. If it is known that a certain number of characters are repetitive, that setting will provide an increase in throughput. However, if the file contents change, become more random, a reduction in throughput will occur. The default setting of 32 characters is a compromise for a typical text file.

DATA COMPRESSION

The CCITT recommendation for V.42bis specifies a data compression mode, as provided by British Telecom Lempel-Ziv (BTLZ). Modem controller protocols have advanced to the point where in addition to providing error-free data transfer with the use of LAPM or MNP 2-4, they can also offer data compression operation.

These data compression schemes are BTLZ and MNP 5. Although MNP 5 is not specifically part of the V.42bis recommendation, it has been included in the XR-2943 to serve only as a further enhancement to

the XR-2943 based modems and ensure data compression compatibility with the established MNP 5 modems.

MNP Class 5 is the protocol for data compression. It is by far the most accepted protocol for this function. CCITT recommendations have updated the V.42 standard to include the BTLZ data compression technique. This new standard is V.42bis, which provides better throughput characteristics than MNP 5.

MNP 5 data compression offers the XR-2900 Fax/Data modem chip set roughly 100% increase in throughput (in data mode), or 200% of nominal. This translates to a maximum modem throughput of 2400 BPS x 2 = 4800 BPS for a text file.

MNP 5 techniques utilize a scheme which abbreviates redundant data characters for a much higher transmission efficiency or throughput increase. Because of its dependency on redundant characters, the amount of improvement will vary. Typical improvement values are in the range of 75 to 125%, or 4200 to 5400 BPS for a 2400 BPS modem link.

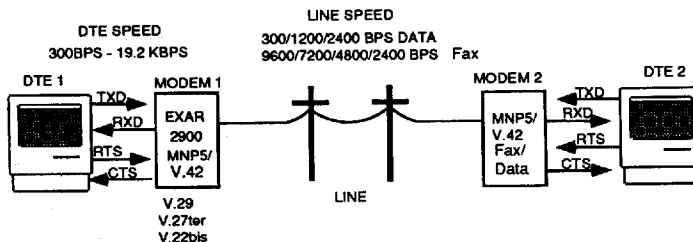

Figure 2. Basic Modem Connection

XR-2943 V.42/MNP FUNCTIONS AND COMMANDS

The XR-2943 with external EPROM provides control for the following major functions:

FUNCTION	DESCRIPTION
<ul style="list-style-type: none"> • 'AT' Command Control • 'AT+F' Commands • MNP Level 2-4 	<ul style="list-style-type: none"> Provides 'AT' Command Set Control Provides control of the FAX functions EIA 2388 (CL2) Provides error correction for 100% perfect data transfer.
<ul style="list-style-type: none"> • MNP Level 5 	<ul style="list-style-type: none"> Allows roughly a 100% increase (4800 BPS for V.22bis mode) in data throughput, through data compression techniques.
<ul style="list-style-type: none"> • V.42bis (BTLZ®) 	<ul style="list-style-type: none"> Using 2-dimensional adaptive coding, 400 % of nominal data throughput is possible.
<ul style="list-style-type: none"> • V.42 (LAPM) • Speed Conversion 	<ul style="list-style-type: none"> 100% perfect data transfer Maintain up to 19,200 BPS DTE (terminal speed) for 300 BPS to 9600 BPS line speeds, both for LAPM/MNP and non-error correcting connections.

XR-2943

T-75-33-90

FLOW CONTROL

As previously outlined, a method for regulating the flow of data to be transmitted is necessary when DTE data rates exceed line rates. Figure 2 illustrates a basic modem connection and helps illustrate where flow controls fit in.

Flow control can be under hardware or software control.

HARDWARE FLOW CONTROL

Hardware Flow Control allows the modem to lower or raise its CTS (Clear to Send) line to the DTE. This provides an ON/OFF control of data flow from DTE to modem. If the modem data buffer becomes full it lowers the CTS line to stop transmit data flow to allow the modem to "catch-up".

SOFTWARE FLOW CONTROL

An alternative to hardware flow control is control by software, known as Xon/Xoff. This is accomplished by special characters inserted into the data stream to start and stop data flow. Control Q (^Q) is used to start or restart data flow and Control S (^S) to stop data flow.

Three different variations of Xon/Xoff control modes are:

- Send Only
- Normal
- Passthrough

Application Software Interface

The firmware of the XR-2943 (combined masked and supporting code) supports the working document of the Telecommunication Industry Association, for fax

'AT&F' commands, temporarily assigned the EIA part number 2388. The level of support is service class 2, which places most of the CCITT T.30 (fax handshaking) command functions in the modem (XR-2901, XR-2902 and XR-2943). Figure 3 indicates the approximate division between modem (DCE) and PC (DTE) for T.30 and T.4 (fax bit mapping).

The command section of the XR-2943 data sheet defines the commands, responses and functions of the firmware supplied with the XR-2943. It is possible to send those commands to the XR-2900 system by keyboard entry, visually monitor the responses and send or receive data of the proper format. However, to use the XR-2900 modem system effectively, it is best to use an application software package that automatically monitors the response strings and acts accordingly.

In general the application software would be required to perform:

- ASCII to Bitmap Conversion
- PCX to Bitmap Conversion
- TIFF to Bitmap Conversion
- PICT to Bitmap Conversion

In an imbedded system, such as a text editor, the above list could be reduced to include only the ASCII to Bitmap Conversion. Because ASCII is encoded, information as to the font, italics, bold, underline, and other word processor options are lost. It is expected that either the communication packages will start recognizing some Word processor options, or an integration of word processors and communication software such as seen today. The second step is to perform:

- BITMAP to 1 Dimensional Coding or
- BITMAP to 2 Dimensional Coding as per the CCITT T.4 specification.

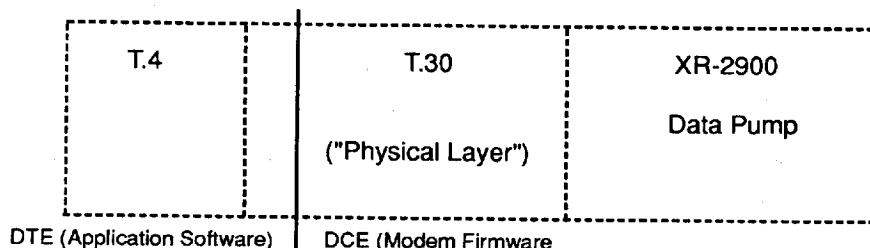

Figure 3. T.4/T.30 Partitioning For DCE/DTE

T-75-33-90

THE QUICK BROWN FOX JUMPED OVER THE LAZY DOG

ASCII Codes: 54 H 48 H 45 H

4C H 41 H

THE

LA

Bit Mapped
Equivalent

First Line: [The LA]

T.4 ...0111 011 000111 0100111 010 000111 011 110 010 1110 010...

Coding: 2W 4B 1W 1B 2W 1B 1W 4B 6W 1B 6W 1B

Figure 4. T.4 Encoding

XR-2943

T-75-33-90

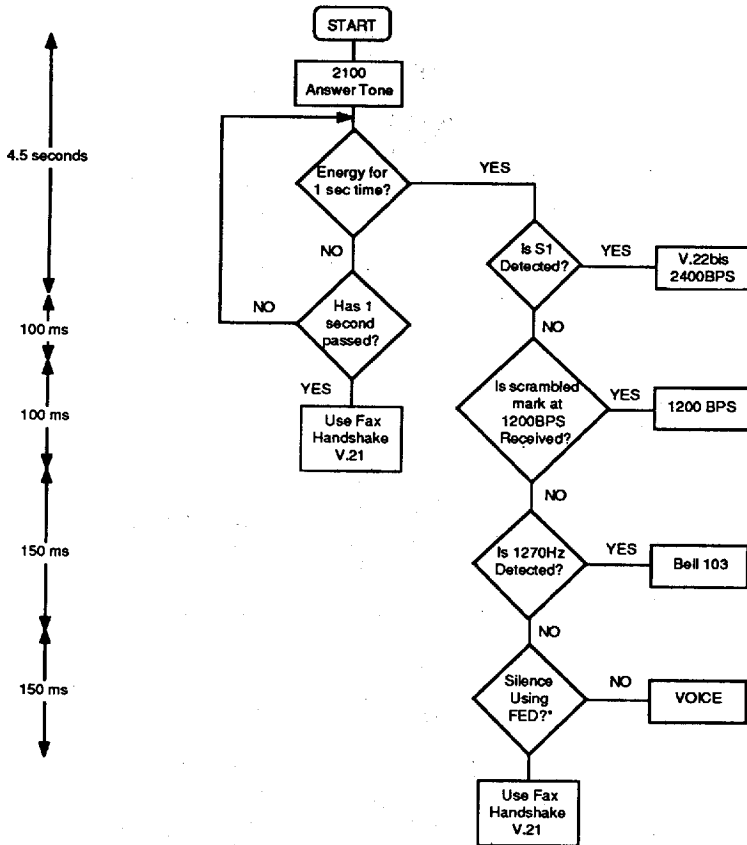

Figure 5. Auto Fax/Data Negotiation For Answer Mode

XR-2943

T-75-33-90

Figure 4 shows the process of taking text and encoding it 1 dimensionally using the CCITT T.4 Huffman codes. The entire line must total 1728 picture elements or pels. The application software will need to convert from files set up for 640 pels per line to one containing 1728 or more.

Modified Huffman encoding is a technique of data compression where unexpected lengths of either black or white are given long codes and the more common run lengths are given much smaller codes. In the example of figure 4, the lengths of white and black are much shorter than found in the typical file and the compression ratio is actually worse than if it was possible to send uncompressed.

In the Vertical dimension, either 98 dpi (dots per inch) or 198 dpi would be selected. This would determine the number of scan lines needed per page as well as determine the quality of the reproduced image. Two dimensional Huffman encoding is not supported. Both of these modes would need to be enabled by using the VR (vertical resolution) and DF (data format) subparameter of the +FDIS command.

AUTO Fax/Data Negotiate: The XR-2943 supports the EIA PN 2388 standard on auto Fax/Data negotiation. Figure 5 shows the flow for this process to proceed. The entire process requires less than 4 seconds permitting it to be compatible with fax machines and data modems available today.

T.30 Description

The CCITT T.30 specification was intended to standardize the signaling between two fax machines. This permits any group III fax card or machine to communicate with another also meeting the standard.

The T.30 specification defines the fax transmission and reception process into five steps or phases:

- Phase A:** Call Establishment
 - Phase B:** Negotiation of data rate, and capabilities of both machines
 - Phase C:** Message (Page) Transmission
 - Phase D:** Post Message (Page) Transmission; confirm send; possibly more pages
 - Phase E:** Call Release (Hang up)
- Figure 6 provides a general flow chart of the process.

Phase A of the CCITT T.30 specification establishes that a fax modem is answering the line and not a data modem. The uniqueness of this handshake allows the ability to add the feature of switching between fax and data modes with the XR-2900 Fax/Data modem chip set. In addition, the optional identification of the called and calling unit takes place using CCITT V.21 modulation and demodulation. The data is framed (synchronous) to ensure reliable communication at this point, even on an extremely poor phone line. By taking this extra step the CCITT has provided a means to negotiate (during Phase B) the data rate to a lower rate, as required. This can be utilized by the application software developer to add a security mode: if the correct response is not provided, the session can be ended at this point.

Phase B is the exchange of information as to capabilities of the two fax modems, again using V.21 channel 2 synchronous transmission and reception. Information such as scanning speed, number of dimensions of Huffman encoding, and grey scale encoding is sent at this time.

Phase B also includes the phasing and training process for the fax modem data pump. The *calling* (originating) modem transmits a bi-phase signal at the proper baud rate for the transmission (2400 symbols/second for 9600 BPS) to allow the called (answering) modem to adjust for group delay distortion as well as gain loss of the line. If not successful, a failure to train (FTT) is sent from the *called* modem to the calling modem at 300 BPS using the framing described above. The *calling* modem tries at the next lower speed. Once this process is successful, the *called* modem confirms that it is programmed to receive.

The sending of the page or information occurs during **Phase C** at the maximum negotiated data rate (9600 BPS for the XR-2900).

Phase D is the confirmation of the end of message and of receiving the page. This usually indicates that the page has been received properly. At this time the optional multiple pages signal can be sent. If another page is to be sent or received, phase C is repeated.

Phase E disconnects the phone line (on hook).

XR-2943

T-75-33-90

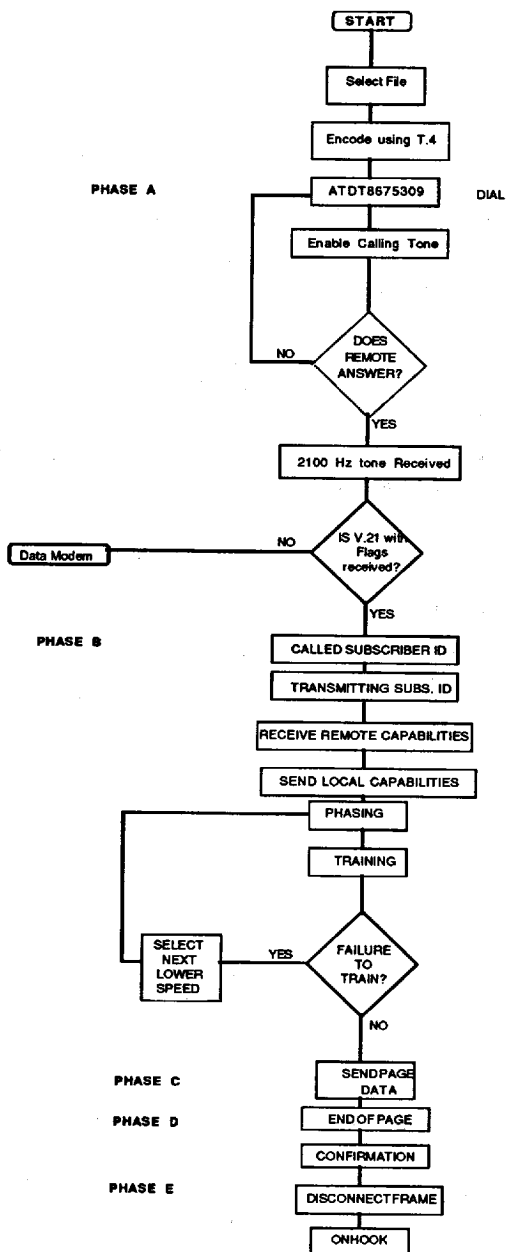

Figure 6. CCITT T.30 Process Sequence (Transmit a Single Page)

XR-2943

T-75-33-90

The XR-2943 supports automatic call establishment. However this does not preclude a manual to automatic process, using an external dialer and starting the application program to send the fax (off hook immediate and wait for phase A to begin).

The process is similar when receiving a call. However, with the Exar proprietary Fax/Data auto select, the modem will determine during phase A whether a fax machine/card or data modem is calling. Details for this are provided in this datasheet.

PROTOCOL NEGOTIATION

During data mode, the XR-2943 supports error correcting or reliable modes of operation for not only LAPM, but also MNP type protocols. Also, since data compression operation is specified by the CCITT V.42bis specifications, BTLZ has been included along with the industry standard MNP@5 for increased compatibility. Because of these multiple protocols supported, and to simplify the command process the XR-2943 offers two powerful protocol negotiation commands:

1) ATM0 Default Mode

This command selects an automatic protocol negotiation mode. First BTLZ (V.42bis) with LAPM negotiation will be attempted. If not possible, MNP operation will be negotiated. The highest possible class of MNP operation will be negotiated (depending upon setting of the %C command). If the remote modem does not support error correction, normal 2400 BPS (or 1200/300 BPS) operation will be supported.

2) ATM1

This command will **disable LAPM and BTLZ** operation. Here only MNP 2-5 and non-error correcting modes of operation will be supported.

It is strongly recommended that the default conditions be used when first starting to use the sophisticated features of the XR-2943. The default conditions have been selected to provide effortless use of the XR-2943.

The following is a command set summary for the XR-2943. Provided are:

Data Mode

- 1) Basic Connection/Dialing Commands
- 2) Dialing Modifiers
- 3) Standard Hayes 'AT' Command Set
- 4) 'S' Register Descriptions/Functions. These registers are used for controlling the value or function of various 'AT' commands.
- 5) BTLZ/MNP/LAPM Commands. The entire list represents the MNP command set. Most of the MNP commands also apply to LAPM, with the exceptions indicated.

Fax Mode

- 6) Extended 'AT + F' Commands for class 2 (support of EIA PN 2388)
- 7) Fax responses

XR-2943

T-75-33-90

COMMAND	DESCRIPTION / RANGE - SIZE
A/ AT ATA ATB0 ATB1 ATB2 ATD ATDP ATDT	Execute previous command, without striking <CR> key Attention Answer Immediate CCITT V.22 mode Bell 212A mode DEFAULT V.23 mode Dial Command Dial Using pulse dial Dial Using DTMF tone dial DEFAULT
The following 8 modifiers will dial using the previously used technique (pulse or tone), or the T or P command can be added after the D (dial) command. 0-9 A B C D * #	
ATDW ATD@ ATD! ATDR ATDS=n ATD/ ATD; ATD. ATE0 ATE1 ATH0 ATH1 ATI0 ATI1 ATI2 ATI3 ATL0 ATL1 ATL2 ATL3 ATM0 ATM1 ATM2 ATM3 ATO ATO1 ATQ0 ATQ1 ATSn? ATSn= ATV0	Wait for Dial Tone for Period Set by S7 Register Quiet Answer: Wait for 5 Seconds of Silence Before Dialing Hookflash: Commonly Used PBX Systems Reverse Answer Mode Dial Stored Number when n= 0-3 Wait 0.125 Seconds Return to Command Mode After Dialing Pause for Time Set by S8 Register Command Echo Disabled Command Mode Echo Enabled DEFAULT Go On Hook (Open Relay) Go Off Hook (Close Relay) Identification Code Identification Code "OK" Response if Checksum Verifies EXAR EPROM Revision Date Lowest Volume Setting Same as ATL0 Medium Volume Setting DEFAULT Maximum Volume Speaker Always Off Speaker On Until Carrier Is Detected DEFAULT Speaker Always On DTMF Tones are not Heard, but Speaker is on Until Carrier Detected Originate Immediate or Return to Data Mode Request a Retrain When in V.22bis Mode Provide Result Codes DEFAULT Disable Result Code Provide S Register Value Set S Register Value Terse (and Verbose) Responses, affected by \Vn

XR-2943

T-75-33-90

NUMERIC	DESCRIPTION / RANGE - SIZE	
		W0
0	OK	Command Executed
1	CONNECT	Connection at 0 to 300 BPs
2	RING	Ring Signal Detected
3	NO CARRIER	Carrier Signal not Detected
4	ERROR	Error
5	CONNECT 1200	Connection at 1200 BPS
6	NO DIALTONE	No DialTone Detected
7	BUSY	Busy Signal Detected
8	NO ANSWER	No Silence Detected
10	CONNECT 2400	Connection at 2400 BPS
11	CONNECT 4800	Connection at 4800 BPS
12	CONNECT 9600	Connection at 9600 BPS
14	CONNECT 19200	Connection at 19200 BPS
		W1
22	CONNECT 1200/REL 4	MNP Class 4 Link
22	CONNECT 1200/REL 5	MNP Class 5 Link
23	CONNECT 2400/REL 4	MNP Class 4 Link
23	CONNECT 2400/REL 5	MNP Class 5 Link
22	CONNECT 1200/V.42	V.42 Link
23	CONNECT 2400/V.42	V.42 Link
22	CONNECT 1200/V.42bis	V.42bis Link
23	CONNECT 2400/V.42bis	V.42 bisLink

3

XR-2943

T-75-33-90

COMMAND	DESCRIPTION / RANGE - SIZE
ATV1	Verbose Response DEFAULT . See ATV0 for Responses
ATX0	Enable Result Codes 0-4
ATX1	Enable Result Codes 0-5, 10
ATX2	Enable Result Codes 0-6, 10
ATX3	Enables Result Codes 0-5 and 7 and 10
ATX4	Enables Result Codes 0-10 DEFAULT
ATY0	Disable Long Space Disconnect DEFAULT
ATY1	Enable Long Space Disconnect
ATZ0	Software Reset, Restore S Register from profile location 0 in NVRAM
ATZ1	Restore S Registers From Profile Location 1 in NVRAM
AT&C0	EIA Carrier Line Always Forced on DEFAULT
AT&C1	EIA Carrier Line Follows Data Carrier
AT&D0	DTR Always on DEFAULT
AT&D1	Modem Goes to Command Mode When DTR Goes Off
AT&D2	Modem Goes on HOOK and Returns to Command Mode When DTR Goes Off
AT&D3	Modem Initializes When DTR Goes Off
AT&F	Fetch S Registers From EPROM for Factory Default
AT&G0	No Guard Tone DEFAULT
AT&G1	550 Hz Guard Tone Enabled
AT&G2	1800 Hz Guard Tone Enabled
AT&J0	RJ-11 Select DEFAULT
AT&K0	Flow Control Disabled
AT&K1	No Function
AT&K2	No Function
AT&K3	RTS/CTS Flow Control Default
AT&K4	Xon/Xoff Flow Control
AT&K5	Xon/Xoff Pass Through
AT&L0	Switched Line Select DEFAULT
AT&L1	Leased Line Select
AT&M0	Asynchronous Mode DEFAULT
AT&M1	Synchronous Mode With Asynchronous Dial
AT&M2	Synchronous Mode and Dial the Stored Number Immediately
AT&M3	Synchronous Mode With DTR Controlling Data/Talk
AT&P0	US Make/Break Ratio For Pulse Dialing DEFAULT
AT&P1	UK Make/Break Ratio For Pulse Dialing
AT&Q0	Direct mode (same as Hayes)
AT&Q1	Same as &M1
AT&Q2	Same as &M2
AT&Q3	Same as &M3
AT&Q5	Error Control Mode
AT&Q6	Normal Mode
AT&R0	Clear To Send (CTS) Follows RTS DEFAULT
AT&R1	CTS Always On
AT&S0	Data Set Ready (DSR) Always on DEFAULT

XR-2943

T-75-33-90

COMMAND	DESCRIPTION / RANGE - SIZE
AT&S1	DSR Normal
AT&T0	Terminate Test in Progress DEFAULT
AT&T1	Initiate Local Analog Loopback For Time Set by Register S18
AT&T2	Not Defined
AT&T3	Initiate Digital Loopback for Time Set by Register
AT&T4	(Not Supported)
AT&T5	Disable Remote Digital Loopback (RDLB) Response
AT&T6	Initiate RDLB
AT&T7	Initiate RDLB with Self Test
AT&T8	Initiate ALB with Self Test (for Direct / Normal Mode only)
AT&W0	Write User Profile 0 into NVRAM
AT&W1	Write User Profile 1 into NVRAM
AT&X0	Modem Provides Transmit Clock
AT&X1	DTE Supplies Transmit Clock (Not Supported)
AT&X2	Slave Clock Mode (Not Supported)
AT&Y0	Power Up Recall User Profile 0
AT&Y1	Power Up Recall User Profile 1
AT&V	List Configuration both Active and Stored
AT&Z m=An	Store Telephone Number into NVRAM (XL93C46) where: <i>m</i> is the number location (0-3) <i>A</i> is <i>P</i> or <i>T</i> (pulse or Tone) <i>n</i> is the telephone number

3

XR-2943

T-75-33-90

COMMAND	LAPM Yes/No	DESCRIPTION/RANGE - SIZE	FUNCTION
AT \ N0	Y	Normal	
AT \ N1	Y	Direct	
AT \ N2	Y	MNP 2-5/Reliable	
AT \ N3	N	MNP 2-5/Auto Reliable	
AT \ N4	Y	V.42 Mode	
AT \ N5	Y	V.42 Mode Auto Reliable	
AT \ N6	Y	V.42 / MNP 2-5 Reliable	
AT \ N7*	Y	V.42 / MNP 2-5 Auto Reliable	
AT \ A0	N	64 Characters	Transmit Block Size
AT \ A1	N	128 Characters	
AT \ A2	N	192 Characters	
AT \ A3*	N	256 Characters	
AT %An	Y	n = 0-127 ASCII	Auto-Reliable Fallback Character
AT \ L0*	N	Stream Link	Block MNP Link (Stream Mode)
AT \ L1	N	Block Link \\L1 = \\L0	
AT \ O	N	Initiate Reliable Link After Escape Command Independent of Modem Initial mode (ANS or ORG)	Originate Reliable Link
AT \ U	N	Accept Reliable Link after Escape Command request from Initiator of Link	Accept Reliable Link
AT \ Y	N	Establish Reliable Link after Connecting in Normal Mode	Switch to Reliable Mode
AT \ Z	N	Switch to Normal Mode After Establishing a Reliable Link	Switch to Normal Mode
AT % C0	Y	Compression Disabled	Compression On/Off Control
AT % C1*	Y	Compression Enabled	
AT \ V0	Y	Standard Non-MNP Result Codes	Result Code Form
AT \ V1*	Y	Modified MNP Result Codes (As Listed Below)	
AT \ Bn	Y	N = 0 - 9 (100ms Increments) Used in Normal Mode Default = 3, Error Control Mode Always 300ms	Transmit Break for Normal Data Mode
AT \ C0*	Y	Does not buffer Data Default	Set Auto-Reliable Buffer Break Control
AT \ C1	Y	Buffers All Data on Answering Modem until 200 Characters (Non-Sync) are Returned	
AT \ C2	Y	Does Not Buffer Data on Answering Modem, according to % An to fall back	
AT \ K1	Y	"Destructive" signaling regardless of its sequence in data sent and received;	Break Control for Reliable Data Mode
AT \ K3	Y	data in process at time is destroyed "Expedited" signaling regardless of its sequence in data sent and received; data integrity maintained	

XR-2943

T-75-33-90

COMMAND	LAPM Yes/No	DESCRIPTION / RANGE - SIZE	FUNCTION
AT \ K5*	Y	"In sequence" signaling as data is sent and received; data integrity maintained ahead of and after break	Inactivity Timer
AT \ K0,2,4	-	Not Supported (Will be equal to AT \ K5 if selected)	
AT \ Tn	Y	N = 0-90 min N* = 0 (disable)	
%D0*	Y	Hang up without clearing buffer	
%D1	Y	Clear the receive buffer before hang up	
- Cn	Y	Maximum String Length(BLTZ) Range: 6-250 Characters Default: 32 Characters	
- Dn	Y	Dictionary Size and One / Two-way Mode(BLTZ), - Dictionary size options 0 - 512 entries, 1 - 1024(1K) entries, *2 - 2048(2K) entries, 3 - 4069(4K) entries	
AT \ I	-	Not Functional	
AT \ J0*	Y	BPS Rate Adjust Disabled	
AT \ J1	Y	BPS Rate Adjust Enabled	
AT \ S	Y	List Profiles	
AT \ G0*	Y	Disables Modem Port Flow Control	Set Modem Port Flow Control
AT \ G1	Y	Sets Modem Port Flow Control to Xon / Xoff	
AT \ X0*	Y	Does Not Pass Xon / Xoff to Remote Modem	Xon / Xoff Pass Through Control
AT \ X1	Y	Passes Xon / Xoff to Remote Modem	
AT \ Q0	Y	Disable Flow Control	Serial Port Flow Control
AT \ Q1	Y	Bidirectional Xon / Xoff Enabled	
AT \ Q2*	Y	Unidirectional Hardware Control by CTS	
AT \ Q3	Y	Bidirectional Hardware Control by RTS / CTS	
AT \ Q4	Y	Unidirectional Xon /Xoff Send Only	
AT \ Q5		Keep CTS off until connect unidirectional hardware flow control	
AT \ Q6		Keep CTS off until connect for bidirectional hardware flow control	
AT % U	Y	Not Functional	Clear Serial Port Speed Serial Port Check Parity
AT - P0*	Y	Ignores Parity for Special Characters	
AT - P1	Y	Processes Special Characters Only if they have Correct Parity	

Note: * Denotes Default Condition

XR-2943

T-75-33-90

See Command
AT \ V1 Above

STANDARD RESULT CODES \ V0		MODIFIED RESULT CODES \ V1	
Verbose	Numeric	Verbose	Numeric
CONNECT	1		
CONNECT 1200	5	CONNECT 1200 / REL 4 or 5	22
CONNECT 2400	10	CONNECT 2400 / REL 4 or 5	23
CONNECT 4800	11		
CONNECT 9600	12	CONNECT 1200/V.42 or V.42bis	22
CONNECT 19200	14	CONNECT 2400/V.42 or V.42bis	23

XR-2943

T-75-33-90

3

S	REGISTER FUNCTION															
S0	Number of Rings to Answer: Default = 0 (no answer)(stored)															
S1	Ring Count: Stores Number of Rings: Resets After Every Call															
S2	Escape Code Character: Default = 043 (ASCII for "+")															
S3	Carriage return Character: Default = 013															
S4	Line Feed Character: Default = 010															
S5	Back Space Character: Default = 008															
S6	Wait for Dial Tone: Default = 002 (seconds) (minimum setting)															
S7	Wait for Carrier After Dial: Default = 030 (seconds)															
S8	Duration of Delay for Comma: Default = 002 (seconds)															
S9	Carrier Detect Response Time: Default = 0.6 (seconds)															
S10	Loss of Carrier Response Time Default = 1.4 (seconds)															
S11	Touch Tone Duration: Default = 095 (milliseconds)															
S12	Escape Code Guard Time: Default = 1 (second)															
S13	Reserved															
S14	Bit Mapped Register: Stored in NVRAM (XL93C46) Bit 0 Reserved Bit 1 Echo Bit 2 Result Codes Bit 3 Numeric Result Codes Bit 4 Always 0 Bit 5 Tone/Pulse Dialing Bit 6 Reserved Bit 7 Answer/Originate															
S15	Reserved															
S16	Test Register Bit 0 ALB Bit 1 Reserved Bit 2 Local Digital Loopback Bit 3 Remote Digital Loopback (Not Supported) Bit 4 Initiate Remote Test Bit 5 Initiate Remote Test With Self Test Bit 6 Analog Loopback With Self Test Bit 7 Reserved															
S17	Reserved															
S18	Test Time Stored in NVRAM (XL93C46) Default = 000 (seconds)															
S19	Reserved															
S20	Reserved															
S21	Bit Mapped Register Stored in NVRAM (XL93C46) READ ONLY Bit 0 0 = RJ11 Jack Bit 1 Not Used Bit 2 CTS RTS Function Bit 3 DTR Function Bit 4 DTR Function <table border="1" style="margin-left: 20px;"> <thead> <tr> <th>Bit 4</th> <th>Bit 3</th> <th>Function</th> </tr> </thead> <tbody> <tr> <td>0</td> <td>0</td> <td>DTR Always True Default</td> </tr> <tr> <td>0</td> <td>1</td> <td>DTR Off, Forces Command State</td> </tr> <tr> <td>1</td> <td>0</td> <td>DTR Off, Forces Modem Offline</td> </tr> <tr> <td>1</td> <td>1</td> <td>Modem Initializes With DTR OFF (ATZ)</td> </tr> </tbody> </table>	Bit 4	Bit 3	Function	0	0	DTR Always True Default	0	1	DTR Off, Forces Command State	1	0	DTR Off, Forces Modem Offline	1	1	Modem Initializes With DTR OFF (ATZ)
Bit 4	Bit 3	Function														
0	0	DTR Always True Default														
0	1	DTR Off, Forces Command State														
1	0	DTR Off, Forces Modem Offline														
1	1	Modem Initializes With DTR OFF (ATZ)														

XR-2943

T-75-33-90

REGISTER NUMBER	REGISTER FUNCTION
S22	Bit 5 EIA Carrier Status
	Bit 6
	Bit 7 Guard Tone Select
	<u>Bit 7</u> <u>Bit 6</u> <u>Function</u>
	0 0 No Guard Tone <u>Default</u>
	0 1 550 Hz Guard Tone
	1 0 1800 Hz Guard Tone
	1 1 Reserved
	Option Bit - Mapped Register
	Bit 0 Determines Speaker Volume
	Bit 1
	<u>Bit 1</u> <u>Bit 0</u> <u>Speaker Volume</u>
	0 0 Low
	0 1 Low
	1 0 Medium <u>Default</u>
	1 1 High
	Bit 2 Determines the Speaker Status
	Bit 3
	<u>Bit 3</u> <u>Bit 2</u> <u>Speaker Status</u>
	0 0 Always Off
0 1 On Until Carrier is Detected <u>Default</u>	
1 0 Always On	
1 1 As '01', Except Off for Dialing	
Bit 4, 5 and 6 Determine Response Messages	
<u>Bit 6</u> <u>Bit 5</u> <u>Bit 4</u> <u>Message</u>	
0 0 0 Basic Message Set	
1 0 0 Extended with Connect 1200 and Connect 2400	
1 0 1 Extended with 'No Dial Tone'	
1 1 0 Extended with 'Busy'	
1 1 1 Extended with All Messages <u>Default</u>	
Bit 7 Determines Off Hook/On Hook (Make/Break) Ratio for Pulse Dialing	
<u>Bit 7</u> <u>Ratio</u>	
0 39/61 (USA and Canada) <u>Default</u>	
1 33/67 (Uk and Hong Kong)	
Option Bit Mapped Register	
(LSB) Bit 0 Not Supported	
<u>Bit 3</u> <u>Bit 2</u> <u>Bit 1</u>	
0 0 0 300	
0 0 1 Not Used	
0 1 0 1200	
0 1 1 2400	
1 0 0 4800	
1 0 1 9600	
1 1 0 19200	
1 1 1 38400(reserved)	
Bit 4 Determines the Parity for Transmitting and Receiving Data	

S23

XR-2943

T-75-33-90

REGISTER NUMBER	REGISTER FUNCTION																																																																										
	<p>Bit 5</p> <table border="1"> <thead> <tr> <th>Bit 5</th> <th>Bit 4</th> <th>Parity</th> </tr> </thead> <tbody> <tr> <td>0</td> <td>0</td> <td>Even <u>Default</u></td> </tr> <tr> <td>0</td> <td>1</td> <td>Space/None</td> </tr> <tr> <td>1</td> <td>0</td> <td>Odd</td> </tr> <tr> <td>1</td> <td>1</td> <td>Mark</td> </tr> </tbody> </table> <p>Bit 6 Determines Guard Tone Frequency</p> <p>Bit 7 (Used in European Applications)</p> <table border="1"> <thead> <tr> <th>Bit 7</th> <th>Bit 6</th> <th>Guard Tone (Hz)</th> </tr> </thead> <tbody> <tr> <td>0</td> <td>0</td> <td>Disabled <u>Default</u></td> </tr> <tr> <td>0</td> <td>1</td> <td>550</td> </tr> <tr> <td>1</td> <td>0</td> <td>1800</td> </tr> <tr> <td>1</td> <td>1</td> <td>Reserved</td> </tr> </tbody> </table> <p>Not Used</p> <p>Delay to DTR (Stored in NVRAM) <u>Default = 005 (seconds)</u></p> <p>RTS to CTS Delay (Synchronous Mode Only) <u>Default = 1 (milliseconds)</u></p> <p>Bit Mapped Register <u>STORED IN NVRAM</u></p> <p>Bit 0</p> <p>Bit 1 Transmission Mode</p> <table border="1"> <thead> <tr> <th>Bit 1</th> <th>Bit 0</th> <th>Function</th> </tr> </thead> <tbody> <tr> <td>0</td> <td>0</td> <td>Asynchronous Mode <u>Default</u></td> </tr> <tr> <td>0</td> <td>1</td> <td>Synchronous Mode 1</td> </tr> <tr> <td>1</td> <td>0</td> <td>Synchronous Mode 2</td> </tr> <tr> <td>1</td> <td>1</td> <td>Synchronous Mode 3</td> </tr> </tbody> </table> <p>Bit 2 Reserved</p> <p>Bit 3 Reserved</p> <p>Bit 4</p> <p>Bit 5 Transmission Mode</p> <table border="1"> <thead> <tr> <th>Bit 5</th> <th>Bit 4</th> <th>Function</th> </tr> </thead> <tbody> <tr> <td>0</td> <td>0</td> <td>Internal Modem Clock Used <u>Default</u></td> </tr> <tr> <td>0</td> <td>1</td> <td>DTE Supplied Clock</td> </tr> <tr> <td>1</td> <td>0</td> <td>Slave Clock Mode</td> </tr> <tr> <td>1</td> <td>1</td> <td>Same as 00</td> </tr> </tbody> </table> <p>Bit 6 CCITT or Bell Handshaking Standard</p> <table border="1"> <tbody> <tr> <td>0</td> <td>CCITT</td> </tr> <tr> <td>1</td> <td>Bell (including CCITT V.22bis) <u>Default</u></td> </tr> </tbody> </table> <p>Bit 7 Reserved</p> <p>Reserved</p> <p>Negotiate Failure Fallback (Affected by %C and \N)</p> <p><u>Bits</u></p> <table border="1"> <tbody> <tr> <td>0</td> <td>Hang Up</td> </tr> <tr> <td>1</td> <td>Attempt a standard asynchronous connection (&Q0)</td> </tr> <tr> <td>3</td> <td>Attempt an asynchronous connection using automatic speed buffering (&Q6)</td> </tr> <tr> <td>4</td> <td>Attempt a V.42 Alternative Protocol connection (MNP compatible); if negotiation fails, attempt a standard asynchronous connection</td> </tr> <tr> <td>5</td> <td>Attempt a V.42 Alternative Protocol connection (MNP compatible); if negotiation fails attempt a standard asynchronous connection</td> </tr> </tbody> </table>	Bit 5	Bit 4	Parity	0	0	Even <u>Default</u>	0	1	Space/None	1	0	Odd	1	1	Mark	Bit 7	Bit 6	Guard Tone (Hz)	0	0	Disabled <u>Default</u>	0	1	550	1	0	1800	1	1	Reserved	Bit 1	Bit 0	Function	0	0	Asynchronous Mode <u>Default</u>	0	1	Synchronous Mode 1	1	0	Synchronous Mode 2	1	1	Synchronous Mode 3	Bit 5	Bit 4	Function	0	0	Internal Modem Clock Used <u>Default</u>	0	1	DTE Supplied Clock	1	0	Slave Clock Mode	1	1	Same as 00	0	CCITT	1	Bell (including CCITT V.22bis) <u>Default</u>	0	Hang Up	1	Attempt a standard asynchronous connection (&Q0)	3	Attempt an asynchronous connection using automatic speed buffering (&Q6)	4	Attempt a V.42 Alternative Protocol connection (MNP compatible); if negotiation fails, attempt a standard asynchronous connection	5	Attempt a V.42 Alternative Protocol connection (MNP compatible); if negotiation fails attempt a standard asynchronous connection
Bit 5	Bit 4	Parity																																																																									
0	0	Even <u>Default</u>																																																																									
0	1	Space/None																																																																									
1	0	Odd																																																																									
1	1	Mark																																																																									
Bit 7	Bit 6	Guard Tone (Hz)																																																																									
0	0	Disabled <u>Default</u>																																																																									
0	1	550																																																																									
1	0	1800																																																																									
1	1	Reserved																																																																									
Bit 1	Bit 0	Function																																																																									
0	0	Asynchronous Mode <u>Default</u>																																																																									
0	1	Synchronous Mode 1																																																																									
1	0	Synchronous Mode 2																																																																									
1	1	Synchronous Mode 3																																																																									
Bit 5	Bit 4	Function																																																																									
0	0	Internal Modem Clock Used <u>Default</u>																																																																									
0	1	DTE Supplied Clock																																																																									
1	0	Slave Clock Mode																																																																									
1	1	Same as 00																																																																									
0	CCITT																																																																										
1	Bell (including CCITT V.22bis) <u>Default</u>																																																																										
0	Hang Up																																																																										
1	Attempt a standard asynchronous connection (&Q0)																																																																										
3	Attempt an asynchronous connection using automatic speed buffering (&Q6)																																																																										
4	Attempt a V.42 Alternative Protocol connection (MNP compatible); if negotiation fails, attempt a standard asynchronous connection																																																																										
5	Attempt a V.42 Alternative Protocol connection (MNP compatible); if negotiation fails attempt a standard asynchronous connection																																																																										
S24																																																																											
S25																																																																											
S26																																																																											
S27																																																																											
S28-35																																																																											
S36																																																																											

3

XR-2943

T-75-33-90

REGISTER NUMBER	REGISTER FUNCTION
S37	Not Supported
S38	Not Supported
S39	Reserved
S40	Not Supported
S41	Not Supported
S43-45	Reserved
S46	Protocol Selection: Bits 136 LAPM only (V.42) 138 V.42bis enable
S47	Not Supported
S48	Feature Negotiation Action 0 Negotiation disabled; presume the remote modem is configured for and has the capabilities necessary for the connection selected with S46 3 Negotiation enabled, but originating modem remains silent during detection phase. For connections with MNP modems; defeats connection sequence with other V.42 modems 7 Negotiation enabled 128 Negotiation disabled; forces fallback options specified in S36 to be taken immediately
S82	Break Handling: Affected by \K commands 3 "Expedited" signaling regardless of its sequence in data sent and received; data integrity maintained 7 "Destructive" signaling regardless of its sequence in data sent and received; data in process at time is destroyed 128 "In sequence" signaling as data is sent and received; data integrity maintained ahead of and after break
S86	Not Supported

Special Notes regarding the use of S registers above S27 and AT/n Commands.

1. Changes of S register values above S27 will effect the profile display for AT/n Commands. AT/n Commands however, do not modify the setting of S registers.
2. It is intended that a user or application software package will use only one method (S register \ n Commands) to effect the error control functions. Use of a combination could result in unpredictable behavior.

XR-2943

T-75-33-90

"AT + F" COMMANDS

The following are the list of commands supported by the XR-2900. They follow the Aug. 20, 1990 EIA standard PN-2388 (class 2).

All of the commands listed can be used in a string length of up to 40 characters, always preceeded by "AT". For example, "AT&D2E1V0+FCLASS=2<CR>" is a valid command sequence. A semicolon(;) must be used to separate =F commands.

COMMAND	DESCRIPTION	RESPONSE	COMMENTS
+FCLASS = <i>n</i>	Establish Class	OK	<i>n</i> integer values are 0 or 2 0 for Data mode 2 for FAX mode
+FCLASS=?	Service Class Setting Default Fax Parameters DCE Capability	0,2	Provides service Class list Indicates latest setting Each number's location in the string represents the function listed below:
+FCLASS?		0 or 2	
+FDCC=VR, BR, WD, LN, DF, ER, FT, ST	Current Session Parameters	OK	VR Vertical Resolution *0 for 98 dpi (dots/inch) 1 for 196 dpi BR DCE Bit Rate (modulation) 0 = 2400 BPS V.27ter 1 = 4800 BPS V.27 ter 2 = 7200 BPS V.29 *3 = 9600 BPS V.29 WD Page Width *0 = 1728 PIXELS IN 215 mm 1 = 2048 pixels in 255 mm 2 = 2432 pixels in 303 mm 3 = 1216 pixels in 151 mm 4 = 864 pixels in 107 mm LN Page Length *0 = A4, 297 mm 1 = B4, 364 mm 2 = unlimited DF Data Format *0 = 1. D Modified Huffman 1 = Not Supported 2 = Not Supported ER ErrorFree Mode *0 = Disable 1 = Not Supported
+FDIS=VR, BR, WD, LN, DF, ER, FT, ST		OK	

3

XR-2943

T-75-33-90

COMMAND	DESCRIPTION	RESPONSE	COMMENTS
+FLID = "Local ID"	Local FAX ID String	OK	FT Binary File Transfer *0 = Disable 1 = Not Supported ST Scan Time 5 = 20 ms 20 character alpha numeric string for identification 0-9 space, +, ASCI 32-127
+FCR = 0	Capability to Receive	OK	DCE will not receive, but will answer and handshake
+FCR = 1		OK	
+FCQ = 0,1	Copy Quality	OK	n = 2, Not Supported
+FBUG = 0, 1	Debug Mode: HDLC Frame	OK	
FMINSP = 0, 1, 2, 3	Minimum Transmit Speed	OK	0: 2400, 1: 4800, 2: 7200, 3: 9600
+FBOR = 0	Bit Order (DCE to DTE)	OK	MSB First
+FBOR = 1		OK	LSB First
+FDR	Begin Phase C Reception	CONNECT	Beginning of file is noted by DC2(12H) character
+FAA = 0	Auto Answer Mode	OK	FAX only communication
+FAA = 1		OK	Auto Fax/Data determination
+FDT =	Begin Sending Page	CONNECT	Marks beginning of Phase C data
+FHPS=0, 1	Handshake Protocol	OK	0: OK 1: Error
+FET=0,2	End of page	OK	1: Not Supported Indicates additional pages if any 0 for another page no parameter changes

XR-2943

T-75-33-90

RESPONSES from XR-2900 FIRMWARE:

The following lists valid responses to be expected from the XR-2942 firmware. The standardization of these responses allows the Application software to verify that a particular mode has been entered and monitoring of the fax transmission or reception process is easier.

RESPONSE	DESCRIPTION	COMMENTS
+FCON	FAX connection	Occurs after V.21 flags received
+FCSI:	Called Station ID	Report ID being Received (originate)
+FTSI:	Transmit Station ID	
+FDIS:	Session Negotiation Parameters	Uses format shown in Commands Section
+FDCS:	Report of DCS Frame Information	The Format is the same as +FDIS command
+FET:0, 2	Post Page Message Response	0: Another Page coming same document 1: Not Supported 2: No more pages or documents
+FPTS: 1, 2		1: Message Confirmation 2: Bad quality
+FHNG: 0	Call terminated status	Normal and proper connections

3

XR-2943

T-75-33-90

APPLICATIONS INFORMATION

The XR-2943 is shown in a typical 'stand-alone' application in the modem schematic. The XR-2943 provides the command controller function for the XR-2900 Fax/Data modem chip set yielding a high quality modem. For data operation the modem operates error-free through LAPM or MNP 2-4 modes and can offer increased throughput with V.42bis or MNP 5. The XR-2321 adds CCITT V.21 and V.23 FSK modes, it is optional and can be eliminated for designs not requiring these modes.

Detailed information for the XR-2900 is available in XR-2900 Fax/Data modem chip set datasheet.

Layout Hints

In order for the XR-2943 to provide optimal support for best performance of the modem, some design hints/rules should be followed.

- Locate the XR-2902 AFE near the DAA section
 - provide for a short transmit / receive carrier input path, away from any digital control lines.
- Maintain separate analog and digital grounds/power lines back to the power supply source.
- Bypass (capacitor decouple) the XR-2901, XR-2902, XR-2943 and op amp power supplies with both 0.01 μ F ceramic and 0.47 μ F tantalum capacitors near their actual pins. Ensure analog/digital supplies are bypassed to their respective ground.
- Crystal - parallel resonant type. Typical loading capacitors are 18pF.

SYSTEM PERFORMANCE

Performance for an error-correcting modem has two major areas.

1) DATA PUMP PERFORMANCE

With error-detection capabilities turned off, the integrity of the data pump to pass data in the presence of impairments. Most often the major specification measured here is the probability of data errors with the receive carrier impaired by noise, or BER (bit error rate) vs S/N (Signal-to-Noise ratio).

Figure 8 shows BER vs S/N for the circuit in Figure 12, as measured with the test set-up in Figure 9.

2) ERROR CONTROLLER PERFORMANCE

The XR-2943, when in LAPM or MNP modes provides the control and detection required to yield perfect data transfer (Data Modem mode).

Beyond error correction, throughput, or data transfer rate, is another important parameter to the modems overall performance.

LAPM and MNP 2-4 Modes are not specifically provided for increased throughput. However an additional benefit of their error-detecting schemes is roughly a 20% increase in throughput. Using the 'Quick Brown Fox....' pattern, both LAPM and MNP 4 modes yielded better than a 20% throughput increase. V.22bis mode was used for this test, with an actual throughput of better than 2900 BPS measured.

MNP 5 Data Compression Included in the XR-2943 allows roughly a 100% throughput increase over the modems nominal data rate. As previously discussed, the throughput performance of MNP 5 varies with different types of data. (Figure 10 shows data for various data patterns). (Figure 11 illustrates the test set-up used for measuring the circuit of Figure 12).

XR-2943

T-75-33-90

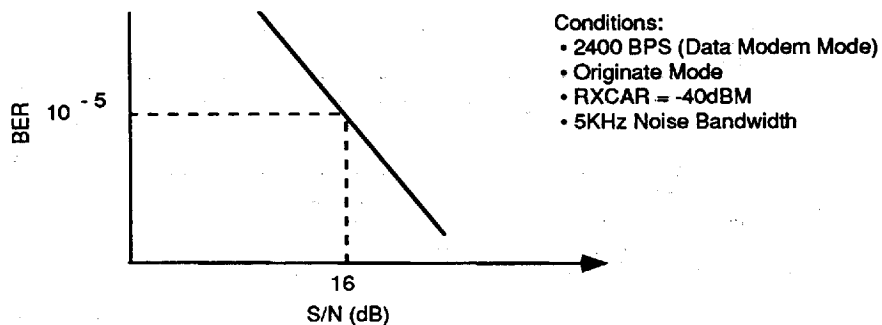

3

Figure 8. 2400 BPS Data Mode BER vs S/N (Non-Error Correcting)

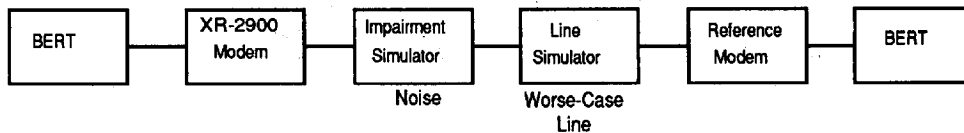

Figure 9. Data Quality Test Set-up

XR-2943

T-75-33-90

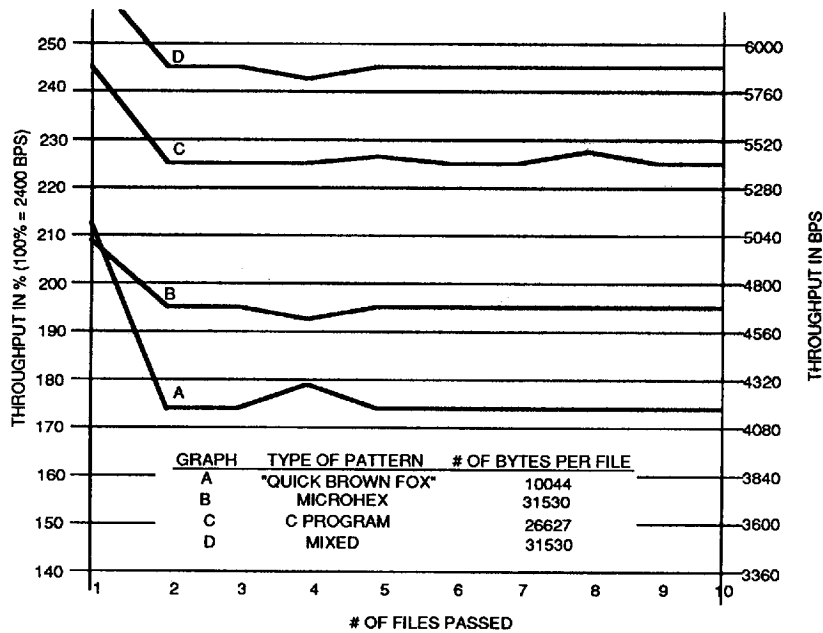
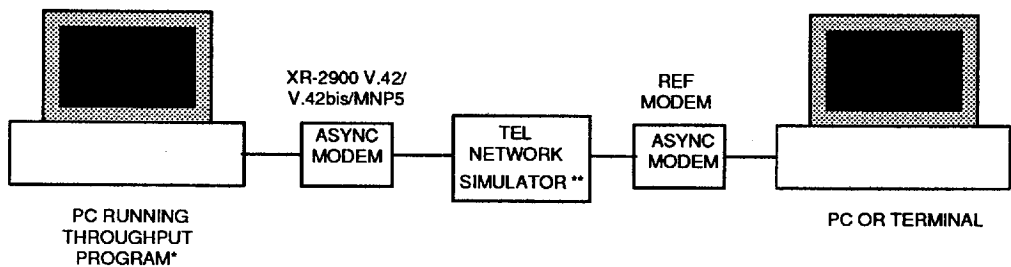

Figure 10. Effective Data Throughput For MNP5



- * APT (asynchronous Performance Tester), also contains data or files to be used during measurement. Product of Concord Data Systems.
- ** Simulates line impairment and attenuation conditions.

Figure 11. MNP5 Throughput Measurement Test (Data Mode)

XR-2943

T-75-33-90

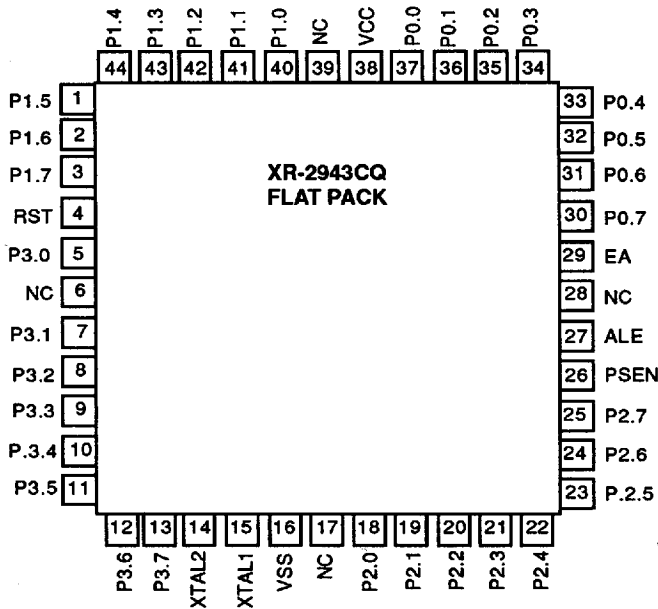
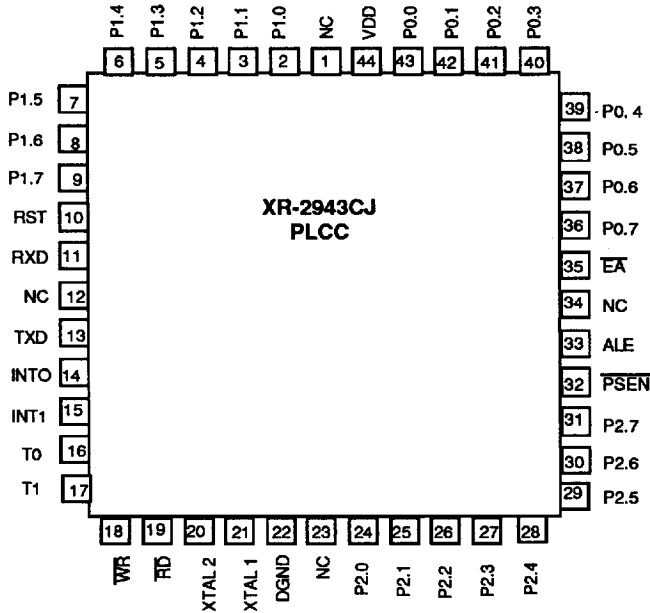

3