

- (1) IO instructions restrict the flow of information between accumulator in CPU, I/O lines, in ROM's and RAM's, and RAM storage. IO stands for IO Read. In this case the CPU will receive data from RAM storage locations or I/O input lines of 4001's.
- (2) The SRC instruction designates the chip number and address for a following IO instruction.

MCS-4 BASIC INSTRUCTION CYCLE

4001 ROM

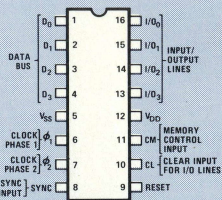

4002 RAM

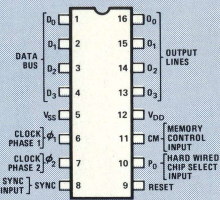

4003 SR

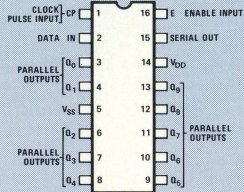

4004 CPU

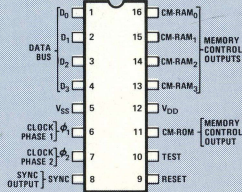

4008

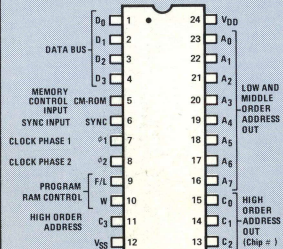

4009

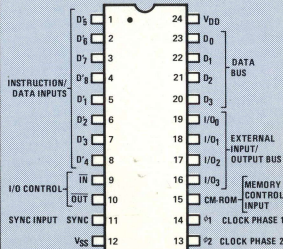

MCS-4^{T.M.} MICRO COMPUTER SET

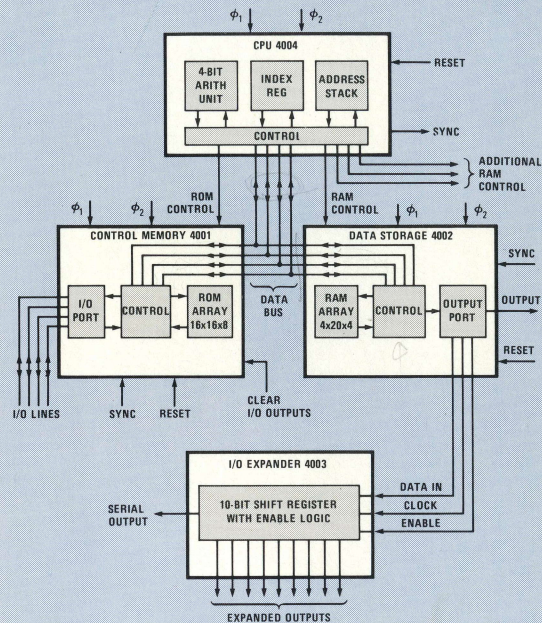

MCS-4 BASIC SYSTEM

intel[®] 3065 Bowers Ave., Santa Clara, Ca., 95051
Phone: (408) 246-7501

MCS-4^{T.M.} Instruction Set

[Those instructions preceded by an asterisk (*) are 2 word instructions that occupy 2 successive locations in ROM]

MACHINE INSTRUCTIONS

MNEMONIC	OPR D ₃ D ₂ D ₁ D ₀	OPA D ₃ D ₂ D ₁ D ₀	DESCRIPTION OF OPERATION
NOP	0 0 0 0	0 0 0 0	No operation.
*JCN	0 0 0 1 A ₂ A ₂ A ₂ A ₂	C ₁ C ₂ C ₃ C ₄ A ₁ A ₁ A ₁ A ₁	Jump to ROM address A ₂ A ₂ A ₂ A ₂ , A ₁ A ₁ A ₁ A ₁ (within the same ROM that contains this JCN instruction) if condition C ₁ C ₂ C ₃ C ₄ (1) is true, otherwise skip (go to the next instruction in sequence).
*FIM	0 0 1 0 D ₂ D ₂ D ₂ D ₂	R R R 0 D ₁ D ₁ D ₁ D ₁	Fetch immediate (direct) from ROM Data D ₂ , D ₁ to index register pair location RRR. (2)
SRC	0 0 1 0	R R R 1	Send register control. Send the address (contents of index register pair RRR) to ROM and RAM at X ₂ and X ₃ time in the Instruction Cycle.
FIN	0 0 1 1	R R R 0	Fetch indirect from ROM. Send contents of index register pair location 0 out as an address. Data fetched is placed into register pair location RRR.
JIN	0 0 1 1	R R R 1	Jump indirect. Send contents of register pair RRR out as an address at A ₁ and A ₂ time in the Instruction Cycle.
*JUN	0 1 0 0 A ₂ A ₂ A ₂ A ₂	A ₃ A ₃ A ₃ A ₃ A ₁ A ₁ A ₁ A ₁	Jump unconditional to ROM address A ₃ , A ₂ , A ₁ .
*JMS	0 1 0 1 A ₂ A ₂ A ₂ A ₂	A ₃ A ₃ A ₃ A ₃ A ₁ A ₁ A ₁ A ₁	Jump to subroutine ROM address A ₃ , A ₂ , A ₁ , save old address. (Up 1 level in stack.)
INC	0 1 1 0	R R R R	Increment contents of register RRRR. (3)
*ISZ	0 1 1 1 A ₂ A ₂ A ₂ A ₂	R R R R A ₁ A ₁ A ₁ A ₁	Increment contents of register RRRR. Go to ROM address A ₂ , A ₁ (within the same ROM that contains this ISZ instruction) if result ≠ 0, otherwise skip (go to the next instruction in sequence).
ADD	1 0 0 0	R R R R	Add contents of register RRRR to accumulator with carry.
SUB	1 0 0 1	R R R R	Subtract contents of register RRRR to accumulator with borrow.
LD	1 0 1 0	R R R R	Load contents of register RRRR to accumulator.
XCH	1 0 1 1	R R R R	Exchange contents of index register RRRR and accumulator.
BBL	1 1 0 0	D D D D	Branch back (down 1 level in stack) and load data DDDD to accumulator.
LDM	1 1 0 1	D D D D	Load data DDDD to accumulator.

INPUT/OUTPUT AND RAM INSTRUCTIONS

(The RAM's and ROM's operated on in the I/O and RAM instructions have been previously selected by the last SRC instruction executed.)

WRM	1 1 1 0	0 0 0 0	Write the contents of the accumulator into the previously selected RAM main memory character.
WMP	1 1 1 0	0 0 0 1	Write the contents of the accumulator into the previously selected RAM output port. (Output Lines)
WRR	1 1 1 0	0 0 1 0	Write the contents of the accumulator into the previously selected ROM output port. (I/O Lines)
WPM	1 1 1 0	0 0 1 1	Write the contents of the accumulator into the previously selected half byte of read/write program memory (for use with 4008/4009 only)
WR ₀ (4)	1 1 1 0	0 1 0 0	Write the contents of the accumulator into the previously selected RAM status character 0.
WR ₁ (4)	1 1 1 0	0 1 0 1	Write the contents of the accumulator into the previously selected RAM status character 1.
WR ₂ (4)	1 1 1 0	0 1 1 0	Write the contents of the accumulator into the previously selected RAM status character 2.
WR ₃ (4)	1 1 1 0	0 1 1 1	Write the contents of the accumulator into the previously selected RAM status character 3.
SBM	1 1 1 0	1 0 0 0	Subtract the previously selected RAM main memory character from accumulator with borrow.
RDM	1 1 1 0	1 0 0 1	Read the previously selected RAM main memory character into the accumulator.
RDR	1 1 1 0	1 0 1 0	Read the contents of the previously selected ROM input port into the accumulator. (I/O Lines)
ADM	1 1 1 0	1 0 1 1	Add the previously selected RAM main memory character to accumulator with carry.
RD ₀ (4)	1 1 1 0	1 1 0 0	Read the previously selected RAM status character 0 into accumulator.
RD ₁ (4)	1 1 1 0	1 1 0 1	Read the previously selected RAM status character 1 into accumulator.
RD ₂ (4)	1 1 1 0	1 1 1 0	Read the previously selected RAM status character 2 into accumulator.
RD ₃ (4)	1 1 1 0	1 1 1 1	Read the previously selected RAM status character 3 into accumulator.

ACCUMULATOR GROUP INSTRUCTIONS

CLB	1 1 1 1	0 0 0 0	Clear both. (Accumulator and carry)
CLC	1 1 1 1	0 0 0 1	Clear carry.
IAC	1 1 1 1	0 0 1 0	Increment accumulator.
CMC	1 1 1 1	0 0 1 1	Complement carry.
CMA	1 1 1 1	0 1 0 0	Complement accumulator.
RAL	1 1 1 1	0 1 0 1	Rotate left. (Accumulator and carry)
RAR	1 1 1 1	0 1 1 0	Rotate right. (Accumulator and carry)
TCC	1 1 1 1	0 1 1 1	Transmit carry to accumulator and clear carry.
DAC	1 1 1 1	1 0 0 0	Decrement accumulator.
TCS	1 1 1 1	1 0 0 1	Transfer carry subtract and clear carry.
STC	1 1 1 1	1 0 1 0	Set carry.
DAA	1 1 1 1	1 0 1 1	Decimal adjust accumulator.
KBP	1 1 1 1	1 1 0 0	Keyboard process. Converts the contents of the accumulator from a one out of four code to a binary code.
DCL	1 1 1 1	1 1 0 1	Designate command line.

NOTES: (1) The condition code is assigned as follows:

C₁ = 1 Invert jump condition C₂ = 1 Jump if accumulator is zero C₄ = 1 Jump if test signal is a 0
C₁ = 0 Not Invert jump condition C₃ = 1 Jump if carry/link is a 1

(2) RRR is the address of 1 of 8 index register pairs in the CPU.

(3) RRRR is the address of 1 of 16 index registers in the CPU.

(4) Each RAM chip has 4 registers, each with twenty 4-bit characters subdivided into 16 main memory characters and 4 status characters. Chip number, RAM register and main memory character are addressed by an SRC instruction. For the selected chip and register, however, status character locations are selected by the instruction code (OPA).

