

SEMICONDUCTOR NOISE FIGURE CONSIDERATIONS

Prepared by
Richard Brubaker
Applications Engineering

A summary of many of the important noise figure considerations related with the design of low noise amplifiers is presented. The basic fundamentals involving noise, noise figure, and noise figure-frequency characteristics are then discussed with the emphasis on characteristics common to all semiconductors. A brief introduction is made to various methods of data sheet presentation of noise figure and a summary is given for the various methods of measurement. A discussion of low noise circuit design, utilizing many of the previously discussed considerations, is included.



MOTOROLA Semiconductor Products Inc.

SEMICONDUCTOR NOISE FIGURE CONSIDERATIONS

INTRODUCTION

The design of low noise amplifiers requires a basic working knowledge of subjects such as circuit stability, cross modulation, noise figure, etc.

The purpose of this report is to provide, in a single working reference, basic semiconductor noise figure considerations. Emphasis is on basic fundamentals rather than complex mathematical derivations. Because much of the theory, particularly with noise, is statistical and quite complicated, derivations will in fact be avoided with details available in suggested references.

NOISE SOURCES

The three types of noise sources generally associated with solid state devices are thermal noise, shot noise and excess noise.

THERMAL NOISE – Thermal noise^{1,2,6,7,16} results from the random motion of free carriers in a medium caused by thermal agitation. Although the sum of all the noise currents over a long period of time is zero, at any given instant a net current in one direction may result. In an ideal resistor, the net current produces a voltage which has a constant spectral density independent of frequency. The self-generated noise voltage across a resistor is:

$$e_n = \sqrt{4 k T R B}$$

where:

e_n = Johnson noise (rms volts)

k = Boltzmann's constant (1.38×10^{-23} joule/°k)

T = Temperature (degrees Kelvin)

R = Effective Resistance (Ohms)

B = Equivalent bandwidth (Hz) of the system through which the noise is measured.

The thermal noise associated with a solid state device results from resistance within the device. Thermal noise in a transistor comes principally from the base spreading resistance (r_b').

SHOT NOISE – Shot noise^{2,6,7,16}, and thermal noise for that matter, depends on the nature of charge carriers for generation. The basic difference, is that thermal noise is produced by the erratic movement of free charge while shot noise is produced by the change (i.e., appearance and

disappearance) of the charge carriers with respect to the circuit current.

The basic equation for full shot noise in a diode is:

$$i_n = \sqrt{2q I_{dc} B}$$

where:

i_n = shot noise (rms amps)

q = electron charge (1.59×10^{-19} coulombs)

I_{dc} = diode direct current (amps)

B = equivalent bandwidth (Hz)

Another important characteristic of both thermal and shot noise is the flat frequency spectrum. This frequency independent characteristic is an important consideration in the construction of equivalent device noise models.

Sources of shot noise in a transistor are currents within the emitter-base and collector-base diodes.⁵

EXCESS NOISE – Excess noise^{2,14,16} usually occurs at low frequencies and is also known as 1/f noise. The exact mechanism producing this phenomenon is not well known. It is thought to be associated with "traps" within the emitter depletion layer which capture and release carriers at different frequency rates but with energy levels varying inversely with frequency. This noise is not only present in junction transistors and field-effect transistors, but also in certain types of resistors.^{1,2} In general, the excess noise in junction transistors and field-effect transistors is negligible above 1 kHz.⁴

NOISE FIGURE

The sensitivity of an amplifier is limited by the signal-to-noise ratio available at the antenna or input. The presence of any of the previously described noise sources within the system only serves to further deteriorate this ratio. The amount of deterioration of the available input signal-to-noise ratio is called the noise figure and may be defined as:

$$F = \frac{P_{si}}{P_{so}} = \frac{P_{ni}}{P_{no}} \frac{1}{G}, \quad (1)$$

Circuit diagrams external to Motorola products are included as a means of illustrating typical semiconductor applications; consequently, complete information sufficient for construction purposes is not necessarily given. The information in this Application Note has been carefully

checked and is believed to be entirely reliable. However, no responsibility is assumed for inaccuracies. Furthermore, such information does not convey to the purchaser of the semiconductor devices described any license under the patent rights of Motorola Inc. or others.

where:

F = noise figure in power ratio

P_{si} = signal input power

P_{ni} = noise input power

P_{so} = signal output power

P_{no} = noise output power

G = power gain of system

Noise figure is generally expressed in decibels, i.e.:

$$F_{(dB)} = 10 \log_{10} \left(\frac{P_{no}}{G P_{ni}} \right) \quad (2)$$

From a practical standpoint, a distinction needs to be made between two types of noise figure, "Spot noise figure"^{3,4} and "average noise figure."³ Spot noise figure is the noise figure measured in a narrow frequency band, useful for specifying the noise figure at individual frequencies. Average noise figure is measured over a particular frequency spectrum such as the bandwidth of an IF amplifier and is useful when specifications approximating total system performance are required.

GENERAL CHARACTERISTICS — A discussion of noise figure variations versus frequency for all types of semiconductor devices is a complex study and actually beyond the scope of this paper. On the other hand, a preliminary study of transistor noise figure versus frequency can cover several general points which are common with other device types. A study of this type usually utilizes an equivalent circuit involving device parameters and noise sources from which noise figure is derived. The complexity of the resultant noise figure expression will vary with the complexity of the equivalent circuit used. A relatively simple yet adequate noise figure expression for this purpose is Nielson's equation.^{5,6,7,8} A modified version of this expression is:

$$F = 1 + \frac{r_e}{2R_g} + \frac{r'_b}{R_g} + \frac{(R_g + r_e + r'_b)^2}{2\beta_o R_g r_e} \left[1 + \beta_o \left(\frac{f}{f_{ab}} \right)^2 \right] \quad (3)$$

where:

$$r_e = \frac{26}{I_E \text{ (mA)}} \text{ (ohms)}$$

r'_b = base spreading resistance (ohms)

R_g = source resistance

β_o = low frequency common emitter current gain

f = frequency (Hz)

f_{ab} = common base cut-off frequency

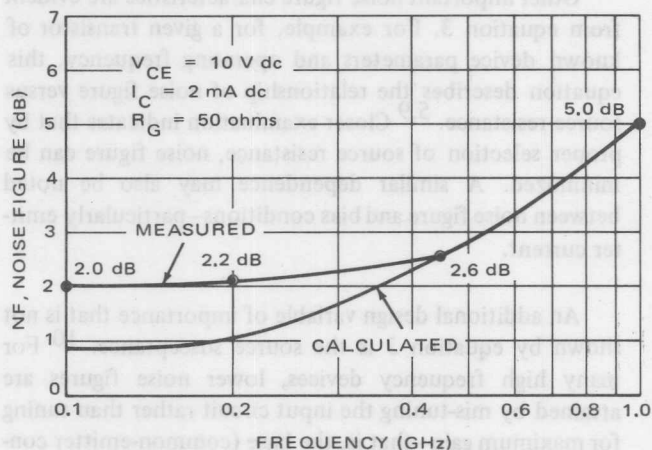

FIGURE 1 — TYPICAL SPOT NOISE FIGURE versus FREQUENCY (CALCULATED AND MEASURED) FOR 2N4957 SILICON PNP TRANSISTOR

The graph in Figure 1 gives both the measured and calculated curves of noise figure versus frequency for the 2N4957 transistor. Generally, the measured curve is flat in the mid-frequency range, increasing at approximately 6 dB per octave at higher frequencies. The discrepancy between measured and calculated values of noise figure in the mid-frequency range results from either not considering all noise sources or not properly analyzing the assumed noise sources. Regardless, the noise model used is reasonably accurate and adequate for the purpose of this paper.

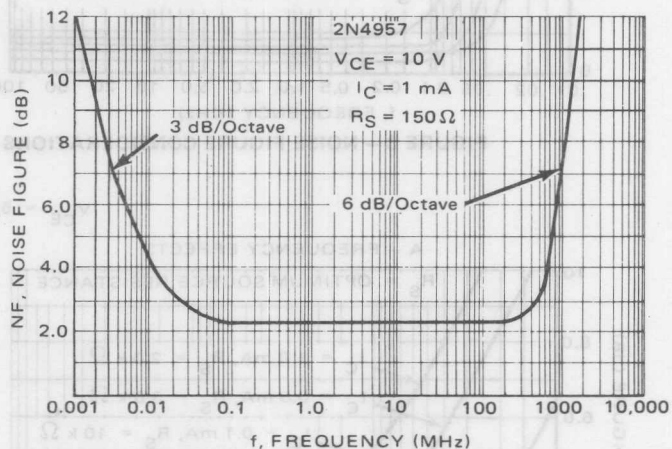

FIGURE 2 — NOISE FIGURE ASYMPTOTES

Transistor noise figure at low frequencies (1 kHz or less) is not predicted by Nielson's equation. The major noise contributor in this region is excess noise. The slope of the curve in this lower frequency is approximately -3 dB per octave. Figure 2 shows a typical noise figure versus frequency curve for the 2N4957 which includes the region affected by excess noise.

Although equivalent noise circuits vary depending on device type (such as junction and MOS-FETs) the same general characteristic noise figure versus frequency curve exists for each (see figures 3, 4, 5, 6 and 7).

Other important noise figure characteristics are evident from equation 3. For example, for a given transistor of known device parameters and operating frequency, this equation describes the relationship of noise figure versus source resistance.^{5,9} Closer examination indicates that by proper selection of source resistance, noise figure can be minimized. A similar dependence may also be noted between noise figure and bias conditions—particularly emitter current.

An additional design variable of importance that is not shown by equation 3 is the source susceptance.¹⁰ For many high frequency devices, lower noise figures are attained by mis-tuning the input circuit rather than tuning for maximum gain—that is, the base (common-emitter con-

figuration) sees a resistance shunted by a susceptance (usually capacitive). The value of this susceptance is found by empirical methods. Again, the considerations are true with junction and MOS field-effect transistors. That is, the noise figure, in general, is optimum for a particular bias point and source admittance.

CHARACTERIZING THE DEVICE

Noise figure curves from device data sheets take several forms. One of the simplest presentations is noise figure versus frequency at a fixed bias point (see Figure 5). This bias point is usually a compromise between minimum noise figure and maximum power gain. Curves of this type, as a rule, do not provide the optimum source resistance necessary for minimum noise figure.

A convenient method of showing source resistance variations for a fixed frequency is shown in Figure 8. This figure shows at a glance the optimum source resistance for

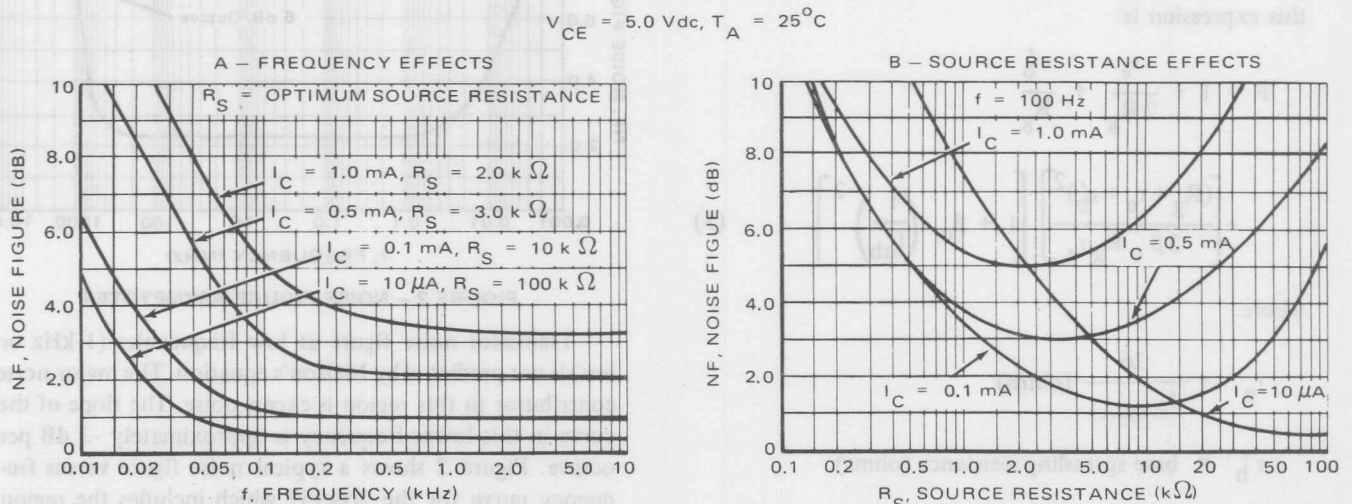
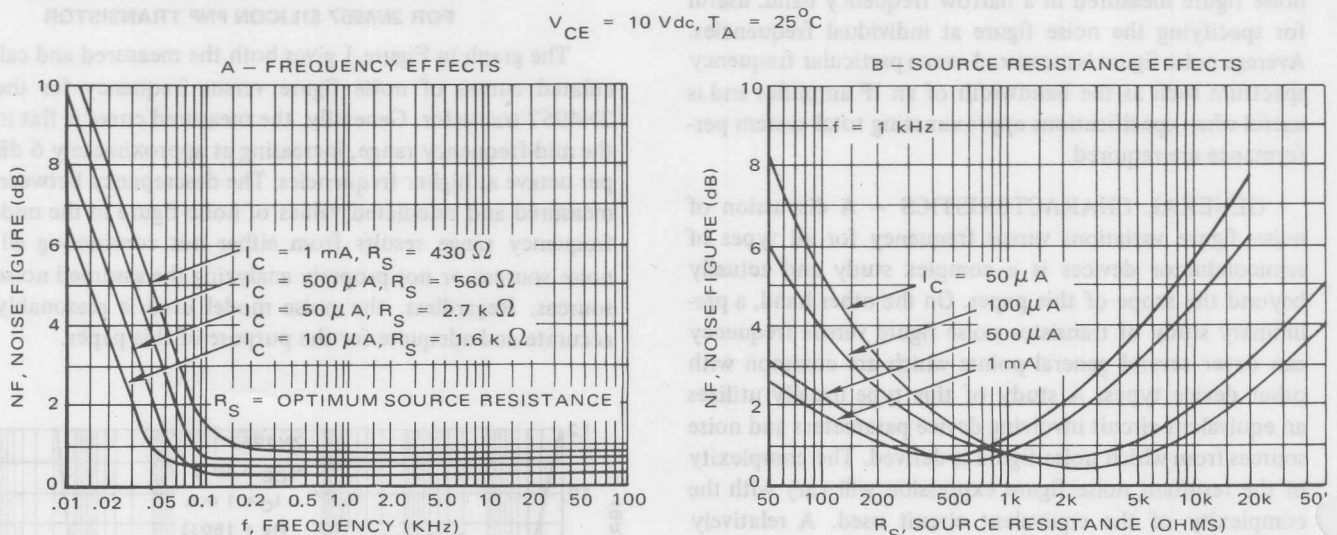

various values of collector current. Similar curves (see Figure 10) at other frequencies allows a more complete picture of noise figure to be made.

Another method of demonstrating source resistance effects is shown in Figure 4B. Here the noise figure is plotted versus source resistance for several values of bias current. This presentation is common for low frequency devices. Another presentation which usually incorporates the previous curve is shown in Figure 4A. This figure shows noise figure versus frequency for several values of collector current. Each value of collector current includes the optimum source resistance for this value of current. The optimum source resistance is usually taken from a figure similar to Figure 4B.

An example of a field-effect transistor presentation similar to Figure 4 is shown in Figure 6 for a junction field-effect and Figure 7 for a tetrode connected junction field-effect transistor.

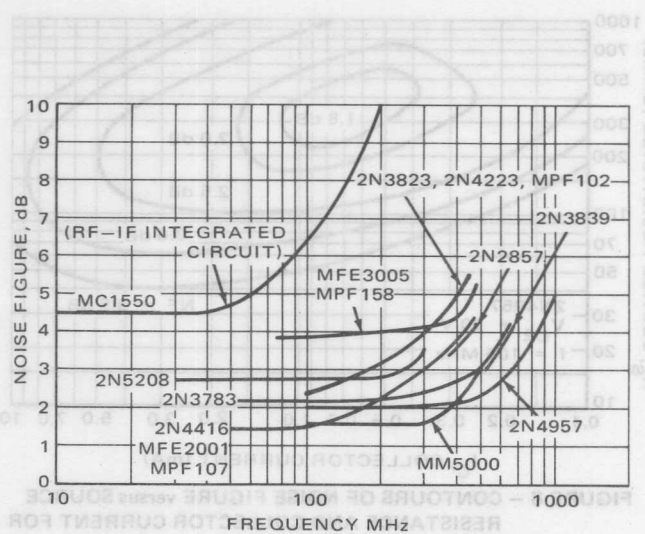

FIGURE 5 - NOISE FIGURE versus FREQUENCY FOR VARIOUS RF SEMICONDUCTOR DEVICES

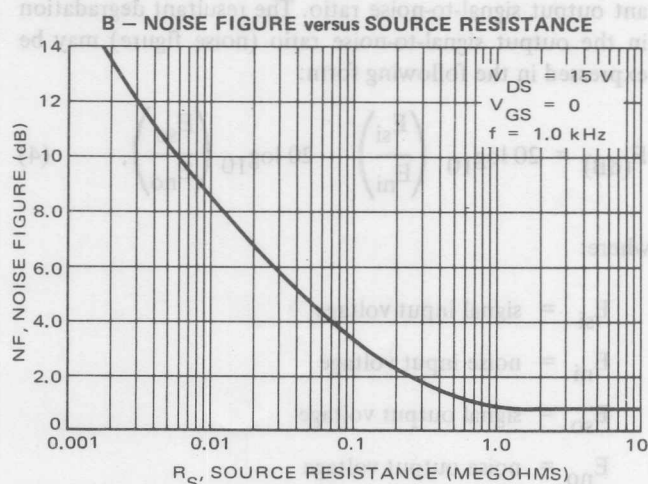
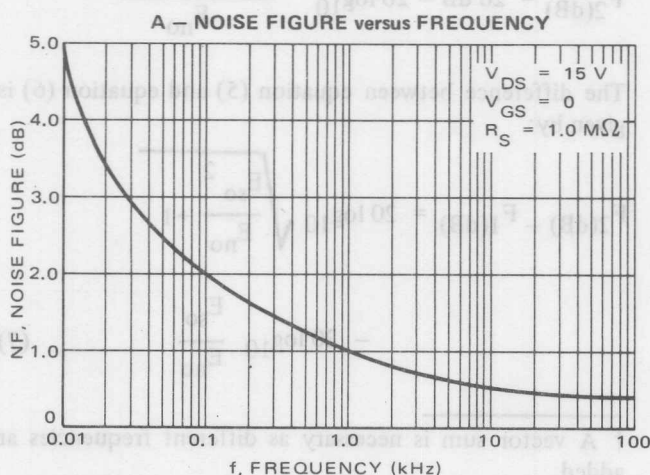

FIGURE 6 - NOISE FIGURE versus FREQUENCY FOR THE 2N4220, J-FET

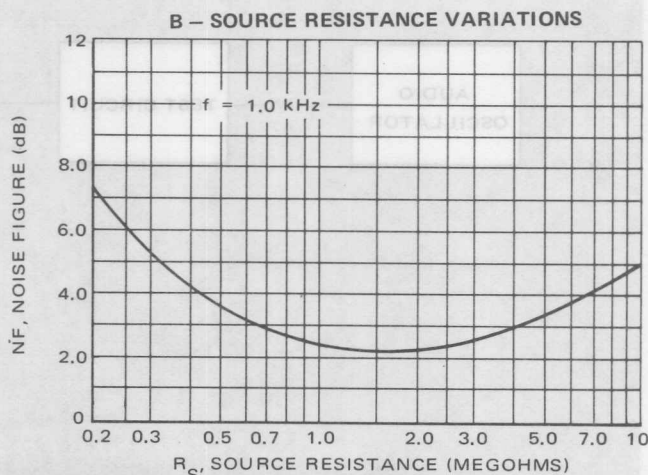
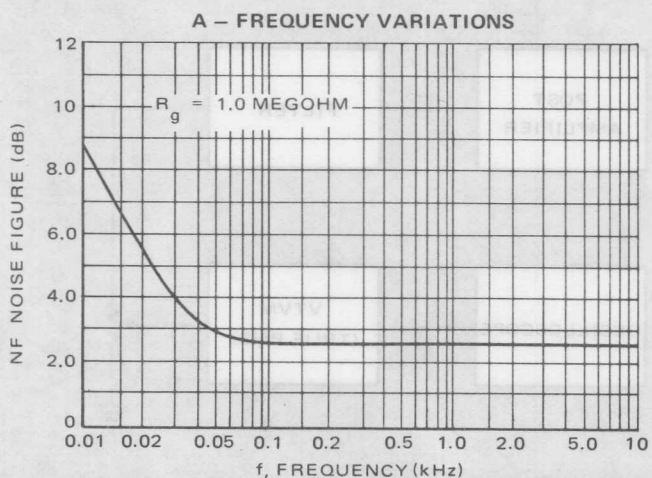

FIGURE 7 - NOISE FIGURE versus SOURCE RESISTANCE FOR THE 3N124, TETRODE J-FET

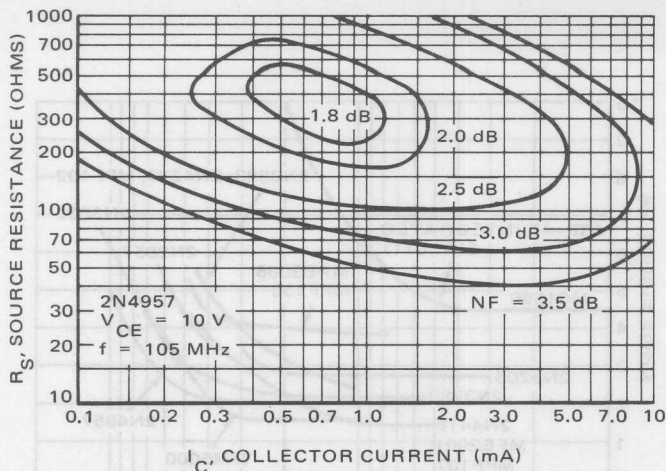

FIGURE 8 - CONTOURS OF NOISE FIGURE versus SOURCE RESISTANCE AND COLLECTOR CURRENT FOR 2N4957 AT 105 MHz

LOW FREQUENCY NOISE FIGURE MEASUREMENTS

SIGNAL GENERATOR METHOD - One of the simplest methods for measuring noise figure at low frequencies is to fix the input signal-to-noise ratio, and note the resultant output signal-to-noise ratio. The resultant degradation in the output signal-to-noise ratio (noise figure) may be expressed in the following form:

$$F(\text{dB}) = 20 \log_{10} \left(\frac{E_{si}}{E_{ni}} \right) - 20 \log_{10} \left(\frac{E_{so}}{E_{no}} \right), \quad (4)$$

where:

E_{si} = signal input voltage

E_{ni} = noise input voltage

E_{so} = signal output voltage

E_{no} = noise output voltage

(For measurement purposes the signal levels are expressed in terms of voltage rather than power.) If the source resistance R_s is known, E_{ni} can be calculated from equation (1) and E_{si} adjusted so the input signal to noise ratio is a convenient value such as 20 dB.

For such a case:

$$F_1(\text{dB}) = 20 \text{ dB} - 20 \log_{10} \left(\frac{E_{so}}{E_{no}} \right). \quad (5)$$

Since the measured output signal also includes E_{no} , the actual signal measured is:

$$\sqrt{E_{so}^2 + E_{no}^2}^\dagger$$

Substituting the measured output signal into equation (5), the original relation becomes:

$$F_2(\text{dB}) = 20 \text{ dB} - 20 \log_{10} \frac{\sqrt{E_{so}^2 + E_{no}^2}}{E_{no}} \quad (6)$$

The difference between equation (5) and equation (6) is given by:

$$F_2(\text{dB}) - F_1(\text{dB}) = 20 \log_{10} \sqrt{\frac{E_{so}^2}{E_{no}^2} + 1} - 20 \log_{10} \frac{E_{so}}{E_{no}} \quad (7)$$

† A vector sum is necessary as different frequencies are added.

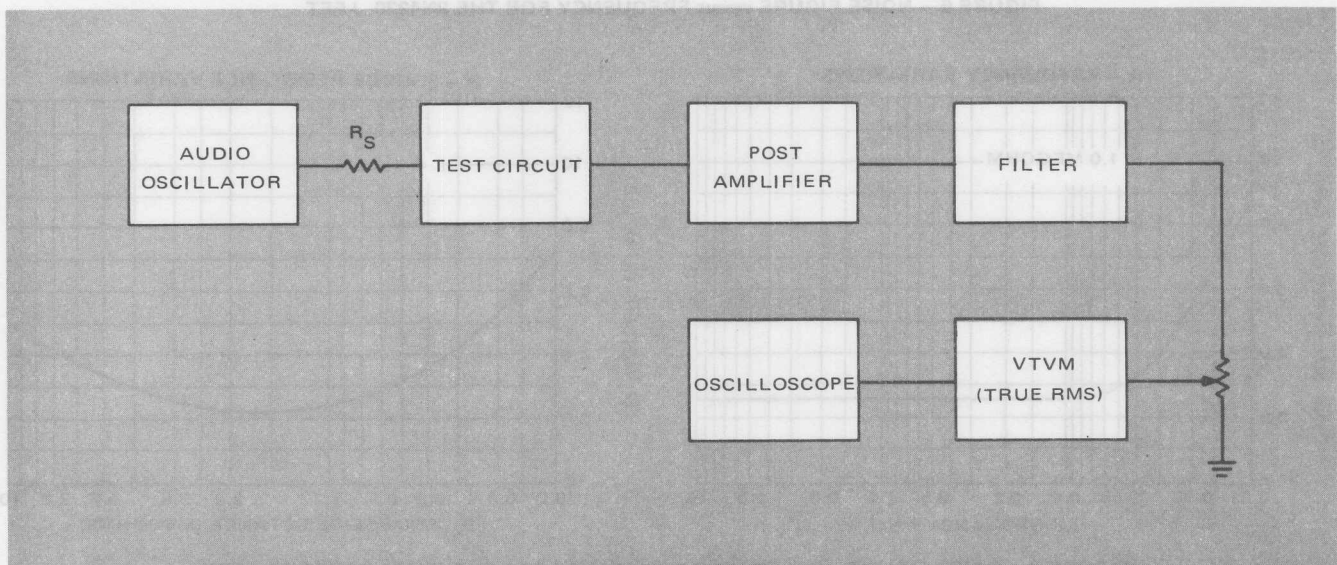

FIGURE 9 - TEST SET-UP FOR LOW FREQUENCY NOISE FIGURE MEASUREMENT-SIGNAL GENERATOR METHOD

As an example, this difference or error is less than 0.5 dB for a device having a noise figure up to 10 dB if the input signal to noise ratio is 20 dB.

The general procedure (see Figure 9) for utilizing this method is as follows: First, adjust the input voltage signal to noise ratio to 20 dB. Second, adjust the variable attenuator such that the voltmeter indication of E_{SO} is full scale. Next, reduce the input signal to zero and note the drop in output voltage (dB). Since the output voltage without a signal is E_{NO} , the actual drop in output in dB represents the ratio of E_{SO} and E_{NO} . This ratio, when subtracted from 20 dB, is the noise figure (without error correction).

CONSTANT-GAIN METHOD

The basis for this method involves maintaining a constant known voltage gain and measuring E_{NO} (see equation 8). Knowing these terms, in addition to the bandwidth (which is determined by a band-pass filter as in the first method) and the source resistance, the noise figure can be calculated. A commercial instrument employing this operating principle is the Quan-Tech Noise Analyzer, Model 2173-2181.

$$F = \frac{P_{no}}{P_{ni}} \frac{1}{G}, \quad G = \text{power gain}$$

or, in terms of voltage:

$$F = \frac{E_{no}^2}{E_{ni}^2 (G_V)^2}; \quad (8)$$

where $G_V =$ voltage gain.

HIGH FREQUENCY NOISE FIGURE MEASUREMENTS

OUTPUT DOUBLING METHOD – Probably the simplest technique to measure noise figure at high frequencies is the noise doubling method. This involves increasing the noise generator output until the noise power in the output is doubled. The noise power produced by the noise generator under these conditions is the same as that produced by the circuit. That is:

$$P_{no} = G P_{ng},$$

where:

P_{no} = noise power out from source and device

G = power gain

P_{ng} = noise generator power output

If this term is substituted into equation (2), we have the following expression:

$$F = \frac{P_{ng}}{P_{ni}} \quad (9)$$

The actual values of both P_{ng} and P_{ni} are functions of not only source resistance but also the input impedance of the "device-under-test" circuit. A convenient method of defining P_{ng} and P_{ni} is on an available power basis, or,

$$P_{ni} = \frac{e_{ni}^2}{4 R_g}, \quad (10)$$

and

$$P_{ng} = \frac{i_{ng}^2 R_g}{4}. \quad (11)$$

For the case where the noise generator used is a temperature-limited tungsten-filament diode with a mean-square current of

$$i_{ng} = 2q I_{dc} B \quad (\text{see shot noise}) \quad (12)$$

$$F = \frac{q I_{dc} R_g}{2 k T_0} \quad (13)$$

Assuming the temperature of the source (T_0) is 290°K and that R_g is 50 ohms, this expression reduces to:

$$F = I_{dc} \quad (\text{in mA}). \quad (14)$$

The actual technique used to double the noise output power involves more than connecting an RF voltmeter to the output of the test circuit and noting when the twice power output point is reached. First, the noise power levels are very low and a post amplifier is required to increase these levels to the capability of the RF voltmeter. In addition, this power amplifier (if spot noise is desired) must have a bandwidth less than the test amplifier and must not overload for the signal levels encountered. Finally, the actual RF voltmeter used must be linear and must respond to the RMS voltage.

The contribution of noise by the post amplifier is taken into account by the following equation:

$$F = F_1 + \frac{F_2 - 1}{G_1} + \frac{F_3 - 1}{G_1 G_2} \dots \frac{F_{(n-1)}}{G_1 G_2 \dots G_{(n-1)}}, \quad (15)$$

where,

F = overall noise figure (power ratio)

F_1 = noise figure of the first stage (power ratio)

F_2 = noise figure of the second stage (power ratio)

F_3 = noise figure of the third stage (power ratio)

G_1 = power gain of the first stage (ratio)

G_2 = power gain of the second stage (ratio).

Additional considerations, such as "image response", are beyond the scope of this paper. For more information on these considerations, see references 18, 19, and 25.

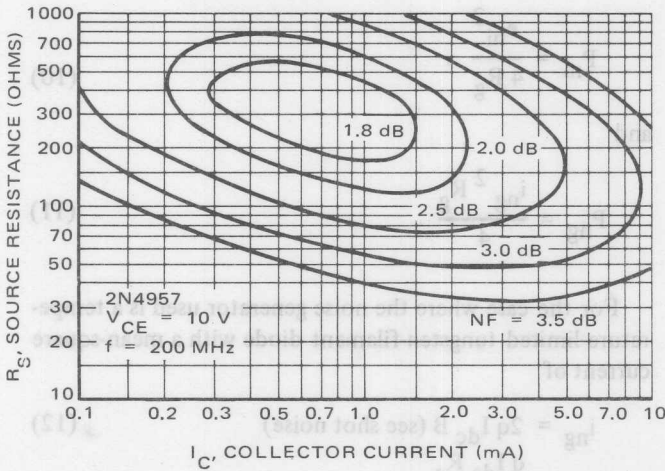

FIGURE 10 — CONTOURS OF NOISE FIGURE versus SOURCE RESISTANCE AND COLLECTOR CURRENT AT 200 MHz

COMMERCIAL EQUIPMENT TECHNIQUE — More sophisticated noise measurement techniques generally use a noise generator with two modes of operation. One mode utilizes the output power from a source such as a temperature limited diode or a gas-discharge tube. The second mode usually utilizes the noise output power of the generator source resistance at room temperature.

A noise generator of this type is connected to the input of a system under test and the two resultant output levels from the "system" are used to determine the noise figure (See Figure 12). The general equation¹⁷ relating noise figure and the two output levels is:

$$F = 10 \log_{10} \left[\frac{T_2 - T_0}{T_0} \right] - 10 \log_{10} \left[\frac{P_{no2}}{P_{no1}} - 1 \right] \quad (16)$$

where the expression $[(T_2 - T_0)/T_0]$ is a measure of the relative excess noise power from the noise generator and P_{no1} and P_{no2} are the two resultant power output levels. These levels correspond respectively to the "fired" and "unfired" modes of operation of the noise source.

The relative excess noise power is usually specified by the manufacturer. A typical value for an Argon gas tube is 15.2 dB. However, for accurate measurements, each source must be individually checked at each frequency of intended use.

Equation (16) is the basis for several of the most popular manual and automatic commercial noise characterization systems.^{17,18,19}

A typical manual noise figure system using an IF attenuator is shown in Figure 11. The objective in using the attenuator is to determine the ratio of P_{no1} and P_{no2} . This ratio is called the "Y" factor. Initially, a convenient detector level is noted with the noise diode in the unfired mode. Next, the noise diode is fired and the attenuator readjusted to reduce the new detector level to the original level. The amount of attenuation added is the ratio of P_{no2} to P_{no1} . The resultant noise figure is calculated by substituting the excess noise power and the attenuator change in equation (16).

Automatic noise measuring equipment in general, gate the noise diode "on" and "off" at a fixed rate and continuously record the output power ratio. Methods of reducing this ratio to a continuous noise figure reading will vary with manufacturer.

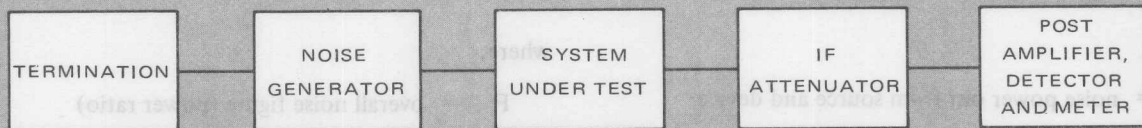

FIGURE 11 — MANUAL NOISE FIGURE SYSTEM USING AN IF ATTENUATOR

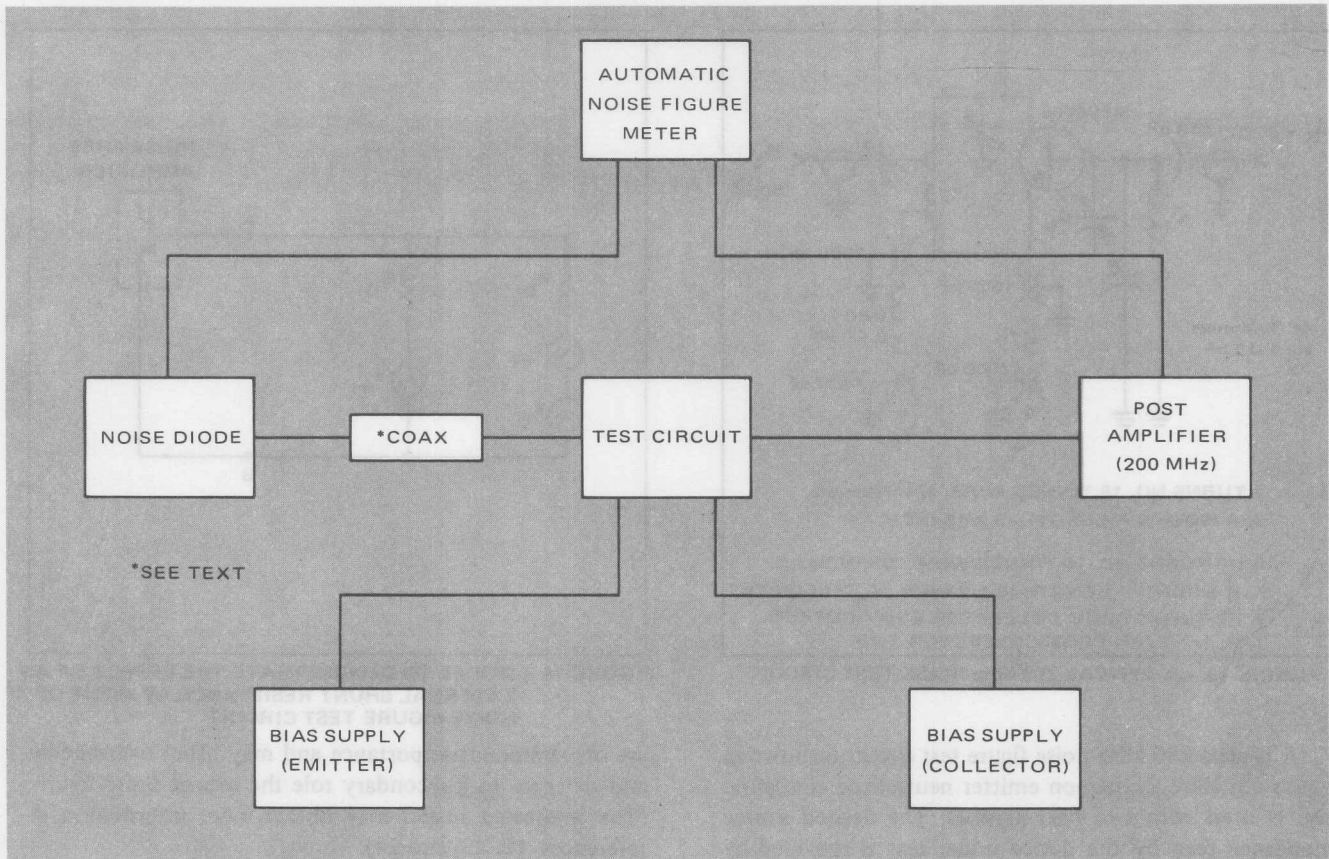

FIGURE 12 – TYPICAL TEST SET-UP FOR 200 MHz NOISE FIGURE MEASUREMENT

TYPICAL VHF NOISE FIGURE MEASUREMENTS USING AUTOMATIC EQUIPMENT

A typical 200 MHz noise figure test set-up using automatic noise measuring equipment is shown in Figure 12.

The noise diode is connected to the test circuit through a special coaxial cable which transforms the 50 ohm noise diode impedance to a higher impedance level, (such as 100 ohms) with negligible circuit loss. Input circuit losses are important since each dB of input circuit loss adds directly to the noise figure. The special coaxial cable length is trimmed to exactly one-quarter of a 200 MHz wavelength, such that when one end of the cable is terminated in 50 ohms, the resultant impedance level at the other end is the desired resistive value with minimum shunting capacitance (0.2 pF max). The cable characteristic impedance necessary to give the desired source resistance is calculated from:

$$R_o^2 = R_S R_L$$

where

R_o = characteristic impedance of cable (ohms)

R_L = resistance of noise diode (50 ohms)

R_g = desired source resistance (ohms)

Several values of source resistance values are readily attained by using coaxial cable with standard values of characteristic impedance. Additional resistance values can be attained by varying the center-conductor wire size of the cable.

Directly following the test amplifier is the post amplifier. This amplifier provides the additional gain necessary to operate the automatic noise figure equipment. Although the required gain is also a function of the test circuit gain, a typical power gain is 50 dB.

Since system bandwidth is determined by the automatic noise equipment, no special bandwidth restrictions are required.

Any contribution of the post amplifier to the total measured noise figure may be calculated with Equation 15. A post amplifier with a noise figure low enough to avoid any significant contribution to the total noise figure is highly desirable.

The input impedance of the post amplifier should be 50 ohms since this impedance level will provide the load for the test circuit. If the device under test is mismatched at the output, the resultant source resistance seen by the post amplifier can increase to several hundred ohms and may result in instability problems with the post amplifier. Consequently, the first stage of the post amplifier should be stable regardless of the source resistance.

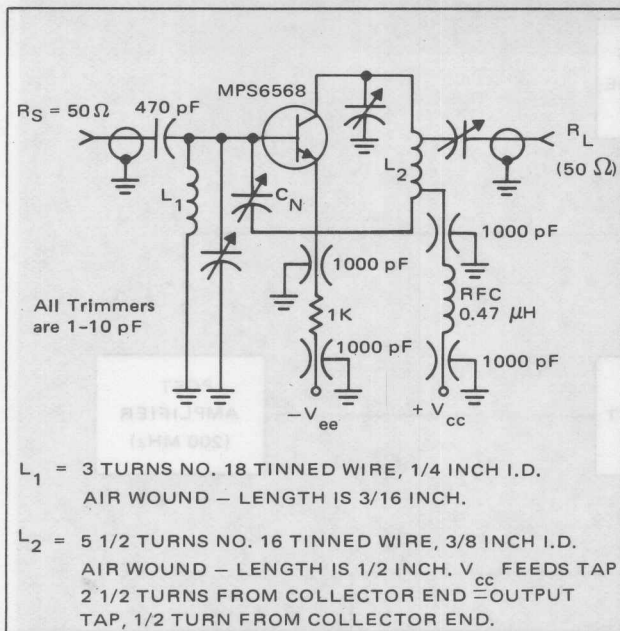

FIGURE 13 — A TYPICAL 200 MHz NOISE TEST CIRCUIT

A typical 200 MHz noise figure test circuit is shown in Figure 13. Here a common emitter neutralized configuration is used with two bias supplies. The desired source impedance seen by the device under test is provided by the special coaxial cable previously discussed, and the input tank circuit provides the necessary tuning. The coil (L_1) must be carefully constructed to minimize input circuit loss; not only should the unloaded Q be high, but the actual inductance value should be as large as possible and still maintain tuning.

In general, all lead lengths should be minimum and circuit layout should be such that the neutralizing capacitor (C_N) is provided the shortest path between the base and L_2 , through a small hole in the shield. Piston-type capacitors are recommended for C_N .

The immediate area should be carefully examined for unknown noise generators. A screen room is certainly a "must." As a general statement, each piece of equipment in the screen room must be examined as a potential noise source. For instance, it is not uncommon to find that the signal generator used to measure power gain, generates a considerable amount of noise power even with the generator output power level reduced.

DESIGN CONSIDERATIONS FOR HIGH FREQUENCY LOW NOISE AMPLIFIERS

The actual design of a low noise amplifier whether intended for audio or RF applications usually involves considerations other than low noise figure. Particularly in high frequency applications, considerations such as cross-modulation, intermodulation distortion and dynamic range

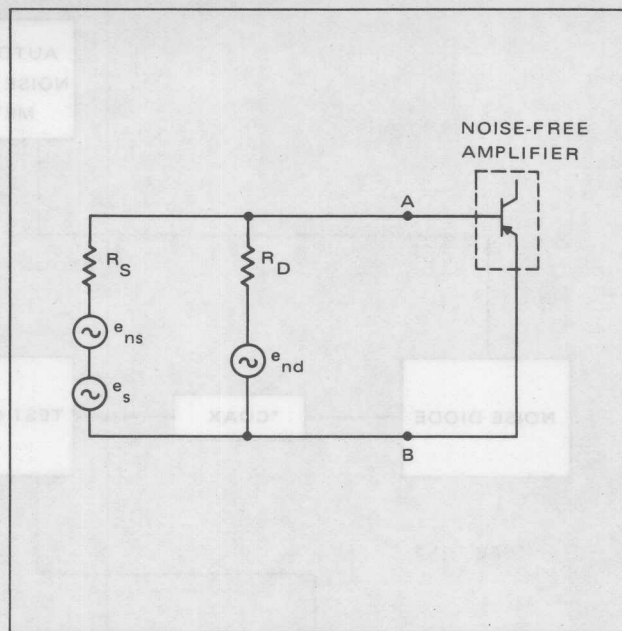

FIGURE 14 — MODEL TO DEMONSTRATE THE EFFECT OF AN EXTERNAL SHUNT RESISTANCE AT INPUT OF NOISE FIGURE TEST CIRCUIT

are of paramount importance and may often overshadow and delegate to a secondary role the overall noise figure. (The interested reader may obtain more information in references 10, 23, and 24).

As previously mentioned, the device must operate under specified bias conditions and generator source admittance to realize the optimum device noise figure. In addition to providing the device with this environment, another major noise contributor, input circuit loss, must also be considered. This circuit loss usually takes the form of an equivalent input shunting resistance resulting from coil loss, bias resistance, capacitor loss, or other component losses such as stand-offs and sockets.

An excellent method of demonstrating the effect of an external resistance shunting the input circuit is to consider the circuit in Figure 14. The amplifier is considered noise free. The calculated noise figure¹⁵ up to point A-B is:

$$F = 1 + \frac{R_S}{R_D}$$

For the case where the shunting resistor R_D equals the source resistance, the noise figure will be degraded 3 dB before the device is even considered. The minimum noise figure occurs when $R_D \gg R_S$ which means that R_D must be large or R_S small. The former condition may be difficult to achieve since the input of the amplifier is generally a tuned circuit and the maximum value of R_D (considering the tuned circuit only) will be limited by practicable coil losses. Correspondingly, R_S may not be arbitrarily reduced since the device requires a certain source resistance for minimum noise figure.

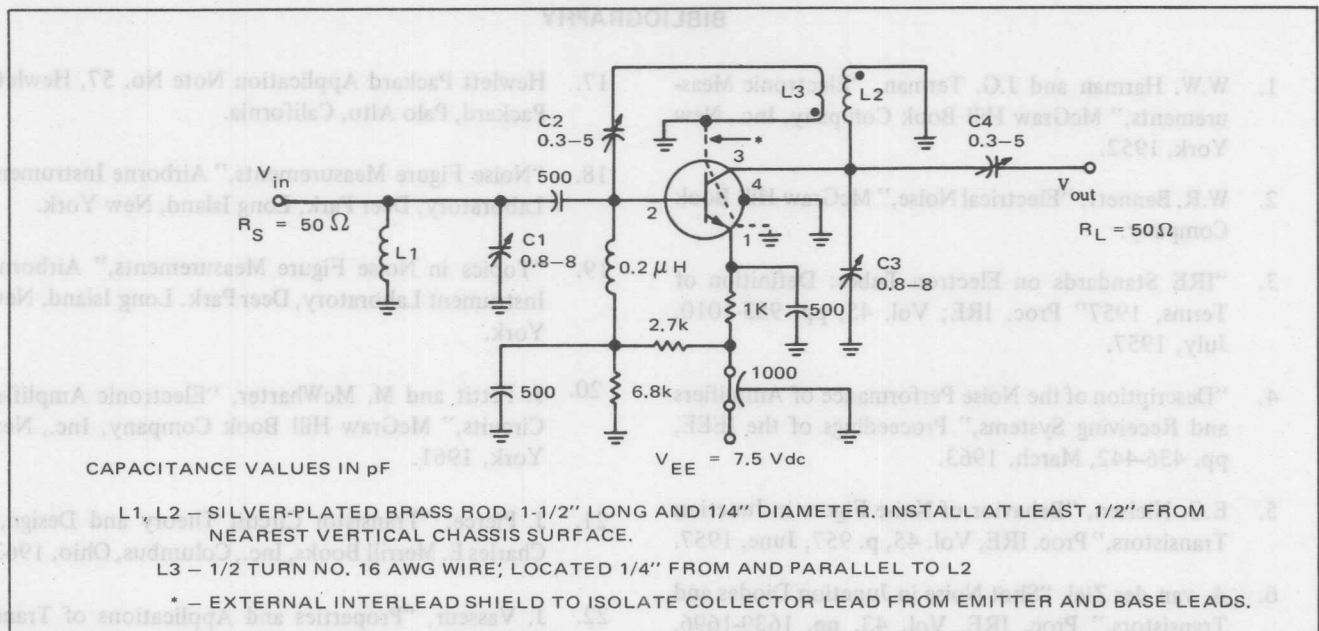
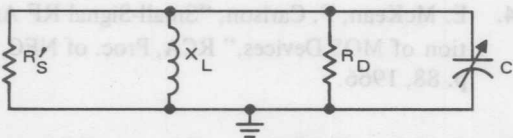

FIGURE 15 – A UHF LOW NOISE TEST CIRCUIT, 450 MHz

The effect of reducing the bandwidth can be seen by examining the following where tuning is shown in the input circuit:



$$R_D = \text{coil loss } (R_D = Q_U X_L)$$

$$X_L = \text{reactance of coil}$$

$$R_S' = \text{optimum source resistance}$$

The circuit bandwidth of this figure is described as:

$$\text{Bandwidth} \cong \frac{X_L f_o}{R'}$$

where:

$$f_o = \text{center frequency}$$

$$R' = \frac{R_D R_S'}{R_D + R_S'} \cong R_S'$$

Thus, it can be seen that reducing the bandwidth for a fixed value of R_S' will require X_L to also decrease. Unfortunately, reducing X_L will also reduce R_D . Thus, decreasing the bandwidth of the input circuit will result in generally a higher noise figure, since the circuit loss increases.

An example of a UHF low noise test circuit is shown in Figure 15 in which noise figures as low as 2.1 dB are measured. 27,28.

The common emitter and common base configuration have approximately the same noise figure.⁵ The final choice of which configuration to use is usually made by carefully considering other factors such as power gain, stability, and whether or not neutralization is acceptable.

DESIGN CONSIDERATIONS FOR LOW FREQUENCY NOISE AMPLIFIERS

Excess noise (the predominant noise contributor at low frequencies) does not fit into a convenient noise model such as proposed by Nielsen. However, empirical investigation shows a similar dependence of noise figure on bias conditions and source impedance (see Figures 3 and 4). This dependence is of considerable importance in low frequency design and may dictate the type of device used (bipolar or field effect transistor). The major difficulty concerns transforming the system source impedance to the desired value (seen by the device) necessary for optimum noise figure. At high frequencies, transformation is readily accomplished with a simple tuned circuit. At low frequencies, however, transformation is limited to a transformer. Transformers are usually avoided if possible because of bandwidth, weight, noise pickup, loss and cost considerations. Consequently, rather than transforming the required source impedance (magnetic pick-up, etc.) to the desired resistance seen by the device, the device is usually selected and biased such that the required resistance seen by the device approximates the actual source resistance.

BIBLIOGRAPHY

1. W.W. Harman and J.G. Terman, "Electronic Measurements," McGraw Hill Book Company, Inc., New York, 1952.
2. W.R. Bennett, "Electrical Noise," McGraw Hill Book Company.
3. "IRE Standards on Electron Tubes: Definition of Terms, 1957" Proc. IRE; Vol. 45, pp. 983-1010, July, 1957.
4. "Description of the Noise Performance of Amplifiers and Receiving Systems," Proceedings of the IEEE, pp. 436-442, March, 1963.
5. E.G. Nielsen, "Behavior of Noise Figure in Junction Transistors," Proc. IRE, Vol. 45, p. 957, June, 1957.
6. A. van der Ziel, "Shot Noise in Junction Diodes and Transistors," Proc. IRE, Vol. 43, pp. 1639-1696, November, 1955.
7. A. van der Ziel, "Shot Noise in Transistors," Proc. IRE, Vol. 48, pp. 114-115, January, 1960.
8. H.A. Haus, et. al., "Representation of Noise in Linear Two-Ports," Proc. IRE, Vol. 48, pp. 69-74, January, 1960.
9. F.M. Gardner, "Optimum Noise Figure of Transistor Amplifiers," Proc. IRE, pp. 45-48, March, 1963.
10. W.A. Rheinfelder, "Design of Low-Noise Transistor Input Circuits." Hayden Book Company, Inc., New York, 1964.
11. J.J. Freeman, "Principles of Noise," John Wiley and Sons, Inc., 1958.
12. H.T. Friss, "Noise Figure of Radio Receivers," Proc. IRE, Vol. 32, No. 7, pp. 419-422, July, 1944.
13. W. Davenport and W. Root, "Random Signals and Noise," McGraw Hill Book Company, Inc., 1958.
14. L. Smullin and H. Haus, "Noise in Electron Devices," John Wiley and Sons, Inc., New York, 1959.
15. K. Sturley, "Radio Receiver Design," John Wiley and Sons, Inc., New York, 1953.
16. A. van der Ziel, "Noise," Prentice-Hall, Inc., 1954.
17. Hewlett Packard Application Note No. 57, Hewlett Packard, Palo Alto, California.
18. "Noise Figure Measurements," Airborne Instrument Laboratory, Deer Park, Long Island, New York.
19. "Topics in Noise Figure Measurements," Airborne Instrument Laboratory, Deer Park, Long Island, New York.
20. J. Pettit and M. McWharther, "Electronic Amplifier Circuits," McGraw Hill Book Company, Inc., New York, 1961.
21. J. Pierce, "Transistor Circuit Theory and Design," Charles E. Merrill Books, Inc., Columbus, Ohio, 1963.
22. J. Vasseur, "Properties and Applications of Transistors," The MacMillan Company, New York, 1964.
23. W. Austin, J. Dean, D. Griswold, and O. Hart, "T.V. Applications of MOS Transistors," RCA Proc. of NEC, Vol. 22, 1966, p. 1061.
24. E. McKean, F. Carlson, "Small-Signal RF Amplification of MOS Devices," RCA, Proc. of NEC, Vol. 22, p. 88, 1966.
25. G. Valley, H. Wallman, "Vacuum Tube Amplifier," p. 720, The McGraw Hill Book Company, Inc., New York, 1948.
26. R. Lane, "The Comparative Performance of FET and Bipolar Transistors at VHF," IEEE Journal of Solid-State Circuits, Vol. SC-1, No. 1, September, 1966.
27. R. Hejhall, "RF Small Signal Design Using 2-Port Parameters," Motorola Application Note AN-215, Motorola Semiconductor Products, Inc., Phoenix, Arizona.
28. D. Brubaker, "UHF Amplifier Design Using Data Sheet Design Curves," Motorola Application Note AN-419, Motorola Semiconductor Products, Inc., Phoenix, Arizona.



MOTOROLA Semiconductor Products Inc.

Printed in Switzerland

AN 421