

# PHILIPS

Data handbook



Electronic  
components  
and materials

## Components and materials

Book C19

1986

Piezoelectric ceramics

# PIEZOELECTRIC CERAMICS

*page*

Description of symbols . . . . .	ii
<b>General</b>	
Introduction . . . . .	1
Materials and grades . . . . .	13
Principal properties . . . . .	14
Applications . . . . .	16
Connection . . . . .	17
Quality aspects . . . . .	18
Stability . . . . .	19
Temperature effects . . . . .	20
<b>Discs and plates</b>	
Type selection . . . . .	28
<b>Actuators</b>	
Introduction . . . . .	35
Flexure elements . . . . .	37
Type selection . . . . .	39
<b>Transducers</b>	
Introduction . . . . .	43
Type selection . . . . .	47
Index of catalogue numbers . . . . .	56

## Description of Symbols

$\epsilon_0$	= dielectric constant of free space = $8,85 \times 10^{-12}$ farads/metre.
$\epsilon^T/\epsilon_0$	= relative dielectric constant, free.
$\epsilon^S/\epsilon_0$	= relative dielectric, clamped
$\tan \delta = \frac{1}{Q_E}$	= dissipation factor at 1 kHz, low electric field.
$k_p$	= planar coupling factor.
$k_{31}$	= transverse or lateral coupling factor.
$k_{33}$	= longitudinal coupling factor.
$k_{15}$	= shear coupling factor.
$k_t$	= thickness coupling factor (laterally clamped).
$d$	= piezoelectric charge constant.
$g$	= piezoelectric voltage constant.
$S^E$	= elastic compliance at constant electric field.
$S^D$	= elastic compliance at constant charge density.
$C^E$	= elastic stiffness at constant electric field.
$C^D$	= elastic stiffness at constant electric charge density.
$Q_m^E$	= mechanical quality factor radial mode.
$N_1$	= frequency constant.

## DATA HANDBOOK SYSTEM

Our Data Handbook System comprises more than 60 books with specifications on electronic components, subassemblies and materials. It is made up of four series of handbooks:

ELECTRON TUBES	BLUE
SEMICONDUCTORS	RED
INTEGRATED CIRCUITS	PURPLE
COMPONENTS AND MATERIALS	GREEN

The contents of each series are listed on pages iv to viii.

The data handbooks contain all pertinent data available at the time of publication, and each is revised and reissued periodically.

When ratings or specifications differ from those published in the preceding edition they are indicated with arrows in the page margin. Where application information is given it is advisory and does not form part of the product specification.

Condensed data on the preferred products of Philips Electronic Components and Materials Division is given in our Preferred Type Range catalogue (issued annually).

Information on current Data Handbooks and on how to obtain a subscription for future issues is available from any of the Organizations listed on the back cover.

Product specialists are at your service and enquiries will be answered promptly.

## ELECTRON TUBES (BLUE SERIES)

The blue series of data handbooks comprises:

- T1 Tubes for r.f. heating**
- T2a Transmitting tubes for communications, glass types**
- T2b Transmitting tubes for communications, ceramic types**
- T3 Klystrons**
- T4 Magnetrons for microwave heating**
- T5 Cathode-ray tubes**  
Instrument tubes, monitor and display tubes, C.R. tubes for special applications
- T6 Geiger-Müller tubes**
- T7 Gas-filled tubes (will not be reprinted)**
- T8 Colour display systems**  
Colour TV picture tubes, colour data graphic display tube assemblies, deflection units
- T9 Photo and electron multipliers**
- T10 Plumbicon camera tubes and accessories**
- T11 Microwave semiconductors and components**
- T12 Vidicon and Newvicon camera tubes**
- T13 Image intensifiers**
- T14 Infrared detectors**
- T15 Dry reed switches**
- T16 Monochrome tubes and deflection units**  
Black and white TV picture tubes, monochrome data graphic display tubes, deflection units

} Data collations on these subjects are available now.  
Data Handbooks will be published in 1985.

## SEMICONDUCTORS (RED SERIES)

The red series of data handbooks comprises:

- S1 Diodes**  
Small-signal germanium diodes, small-signal silicon diodes, voltage regulator diodes (< 1,5 W), voltage reference diodes, tuner diodes, rectifier diodes
- S2a Power diodes**
- S2b Thyristors and triacs**
- S3 Small-signal transistors**
- S4a Low-frequency power transistors and hybrid modules**
- S4b High-voltage and switching power transistors**
- S5 Field-effect transistors**
- S6 R.F. power transistors and modules**
- S7 Surface mounted semiconductors**
- S8 Devices for optoelectronics**  
Photosensitive diodes and transistors, light-emitting diodes, displays, photocouplers, infrared sensitive devices, photoconductive devices.
- S9 Power MOS transistors**
- S10 Wideband transistors and wideband hybrid IC modules**
- S11 Microwave transistors**
- S12 Surface acoustic wave devices**

## INTEGRATED CIRCUITS (PURPLE SERIES)

The purple series of data handbooks comprises:

### EXISTING SERIES

Superseded by:

<b>IC1</b>	<b>Bipolar ICs for radio and audio equipment</b>	IC01N
<b>IC2</b>	<b>Bipolar ICs for video equipment</b>	IC02Na and IC02Nb
<b>IC3</b>	<b>ICs for digital systems in radio, audio and video equipment</b>	IC01N, IC02Na and IC02Nb
<b>IC4</b>	<b>Digital integrated circuits</b> CMOS HE4000B family	
<b>IC5</b>	<b>Digital integrated circuits – ECL</b> ECL10 000 (GX family), ECL100 000 (HX family), dedicated designs	IC08N
<b>IC6</b>	<b>Professional analogue integrated circuits</b>	
<b>IC7</b>	<b>Signetics bipolar memories</b>	
<b>IC8</b>	<b>Signetics analogue circuits</b>	IC11N
<b>IC9</b>	<b>Signetics TTL logic</b>	IC09N and IC15N
<b>IC10</b>	<b>Signetics Integrated Fuse Logic (IFL)</b>	IC13N
<b>IC11</b>	<b>Microprocessors, microcomputers and peripheral circuitry</b>	IC14N

## NEW SERIES

<b>IC01N</b>	<b>Radio, audio and associated systems</b> Bipolar, MOS	(published 1985)
<b>IC02Na</b>	<b>Video and associated systems</b> Bipolar, MOS Types MAB8031AH to TDA1524A	(published 1985)
<b>IC02Nb</b>	<b>Video and associated systems</b> Bipolar, MOS Types TDA2501 to TEA1002	(published 1985)
<b>IC03N</b>	<b>Integrated circuits for telephony</b>	(published 1985)
<b>IC04N</b>	<b>HE4000B logic family</b> CMOS	
<b>IC05N</b>	<b>HE4000B logic family – uncased ICs</b> CMOS	(published 1984)
<b>IC06N</b>	<b>High-speed CMOS; PC54/74HC/HCT/HCU</b> Logic family	(published 1985)
<b>Supplement to IC06N</b>	<b>High-speed CMOS; PC74HC/HCT/HCU</b> Logic family	(published 1985)
<b>IC07N</b>	<b>High-speed CMOS; PC54/74HC/HCT/HCU – uncased ICs</b> Logic family	
<b>IC08N</b>	<b>ECL 10K and 100K logic families</b>	(published 1984)
<b>IC09N</b>	<b>TTL logic series</b>	(published 1984)
<b>IC10N</b>	<b>Memories</b> MOS, TTL, ECL	
<b>IC11N</b>	<b>Linear LSI</b>	(published 1985)
<b>IC12N</b>	<b>Semi-custom gate arrays &amp; cell libraries</b> ISL, ECL, CMOS	
<b>IC13N</b>	<b>Semi-custom</b> Integrated Fuse Logic	(published 1985)
<b>IC14N</b>	<b>Microprocessors, microcontrollers &amp; peripherals</b> Bipolar, MOS	(published 1985)
<b>IC15N</b>	<b>FAST TTL logic series</b>	(published 1984)

### Note

Books available in the new series are shown with their date of publication.



## COMPONENTS AND MATERIALS (GREEN SERIES)

The green series of data handbooks comprises:

- C1 Programmable controller modules**  
PLC modules, PC20 modules
- C2 Television tuners, coaxial aerial input assemblies, surface acoustic wave filters**
- C3 Loudspeakers**
- C4 Ferroxcube potcores, square cores and cross cores**
- C5 Ferroxcube for power, audio/video and accelerators**
- C6 Synchronous motors and gearboxes**
- C7 Variable capacitors**
- C8 Variable mains transformers**
- C9 Piezoelectric quartz devices**
- C10 Connectors**
- C11 Varistors, thermistors and sensors**
- C12 Potentiometers, encoders and switches**
- C13 Fixed resistors**
- C14 Electrolytic and solid capacitors**
- C15 Ceramic capacitors**
- C16 Permanent magnet materials**
- C17 Stepping motors and associated electronics**
- C18 Direct current motors**
- C19 Piezoelectric ceramics**
- C20 Wire-wound components for TVs and monitors**
- C21\* Assemblies for industrial use**  
HNIL FZ/30 series, NORbits 60-, 61-, 90-series, input devices
- C22 Film capacitors**

\* Will be issued in 1985.

## INTRODUCTION

Piezoelectricity is the general term to describe the property exhibited by certain crystals of becoming electrically polarized when stress is applied to them. Quartz is a good example of a piezoelectric crystal. If stress is applied to such a crystal, it will develop an electric moment proportional to the applied stress. This is the *direct piezoelectric effect*. Conversely, if it is placed in an electric field, a piezoelectric crystal changes its shape slightly. This is the *inverse piezoelectric effect* and is a thermodynamic consequence of the direct effect.

Piezoelectricity is also exhibited by ferroelectric crystals, e.g. tourmaline and Rochelle salt. These already have a spontaneous polarization, and the piezoelectric effect shows up in them as a change in this polarization.

Besides the crystals mentioned above, an important group of piezoelectric materials are the piezoelectric ceramics, of which PXE is an example. These are polycrystalline ferroelectric materials with the perovskite crystal structure — a tetragonal/rhombohedral structure very close to cubic. They have the general formula  $ABO_3$  (Fig. 1), in which A denotes a large divalent metal ion such as Pb, and B denotes a small tetravalent metal ion such as Zr or Ti.

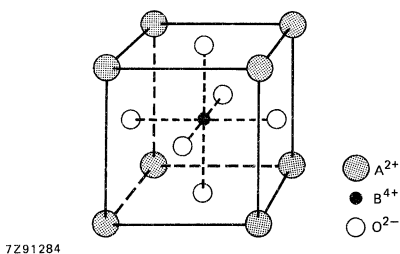

Fig. 1.

PXE can be fashioned into components of almost any shape and size. And as well as being strongly piezoelectric, PXE is hard, strong, chemically inert and completely unaffected by humid environments.

The PXE ceramics in this Data handbook are solid solutions of lead titanate ( $PbTiO_3$ ), and lead zirconate ( $PbZrO_3$ ), modified by additives. They are available in several grades distinguished by their electrical and physical properties to meet particular requirements.

### THE PIEZOELECTRIC EFFECT IN CERAMIC MATERIALS

In a ferroelectric crystal, each cell of the crystal lattice spontaneously polarizes along one of a series of allowed directions. This spontaneous polarization disappears at a critical temperature (the Curie point), above which the crystal becomes paraelectric.

If the crystal is cooled through its Curie point in the presence of an external electric field, the dipoles tend to align in the allowed direction most nearly aligned with the field. If this crystal is then stressed, the lattice will distort, leading to a change in the dipole moment of the crystal (piezoelectric effect). Within a certain stress range (which depends on the crystal concerned), this change in dipole moment with stress is approximately linear and reversible.

A PXE ceramic may be regarded as a mass of minute crystallites, randomly oriented. After it has been fired, the ceramic material will be isotropic and will exhibit no piezoelectric effect because of this random orientation.

The ceramic may be made piezoelectric in any chosen direction by a poling treatment which involves exposing it to a strong electric field. When the field is removed, the dipoles remain locked in alignment, giving the ceramic material a *remanent* polarization and a permanent deformation (i.e. making it anisotropic), as well as making it permanently piezoelectric. This poling treatment is usually the final stage of PXE component manufacture.

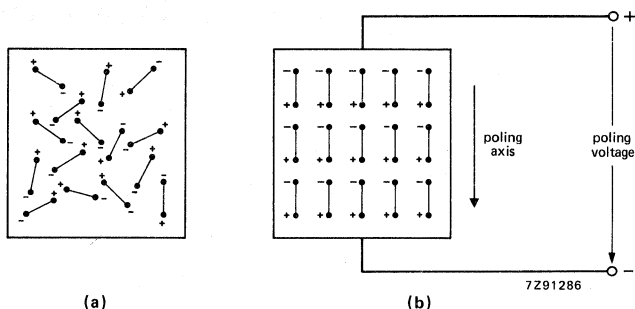

Fig. 2 Electric dipoles (of the domain) in piezoelectric materials (a) before and (b) after polarization (ideal conditions).

A PXE component will usually have metal electrodes deposited on its surface perpendicular to its poling axis (Fig. 2). When a voltage is applied between them, the body distorts along its poling axis. The random orientation of the crystallites, and the fact that only certain polarization directions are allowed, means that it is not possible to get perfect dipole alignment with the field. A reasonable degree of alignment is, however, possible since there are several allowed directions within each crystalline.

Figure 3 illustrates the piezoelectric effect in a cylinder of PXE material. For clarity the magnitude of the effect has been exaggerated.

Figure 3a shows the cylinder under no-load conditions. If an external force produces compressive or tensile strain in the material, the resulting change in dipole moment causes a voltage to appear between the electrodes. If the cylinder is compressed, the voltage will have the same polarity as the poling voltage (Fig.3b). If it is stretched, the voltage across the electrodes will have opposite polarity to the poling voltage (Fig. 3c). These are examples of *generator action* – the conversion of mechanical energy into electrical energy. Examples of piezoelectric-induced generator action can be found in cigarette and gas lighters, gramophone pick-ups, accelerometers, hydrophones and microphones.

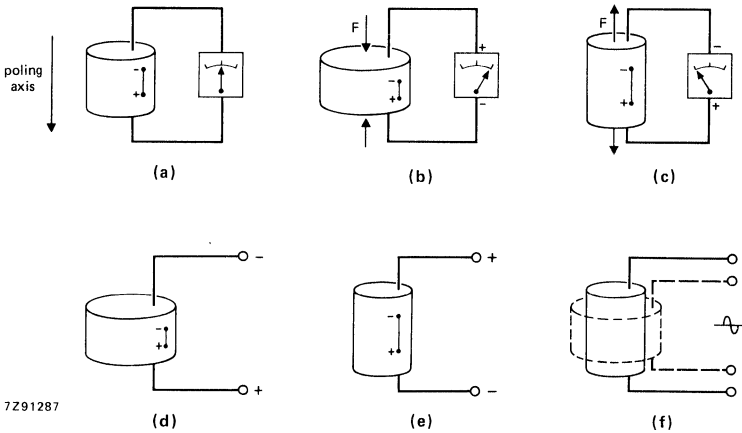

Fig. 3 The piezoelectric effect on a cylindrical body of piezoelectric ceramic. For the sake of clarity only one dipole is shown.

If a voltage of opposite polarity to the poling voltage is applied to the electrodes, the cylinder will shorten (Fig. 3d). If the applied voltage has the same polarity as the poling voltage, the cylinder will lengthen (Fig. 3e). Finally, if an alternating voltage is applied to the electrodes, the cylinder will grow and shrink at the same frequency as that of the applied voltage. These are examples of *motor action* – conversion of electrical energy into mechanical energy. PXE-induced motor action is found in transducers for ultrasonic cleaning equipment, ultrasonic atomizers and fuel injection systems.

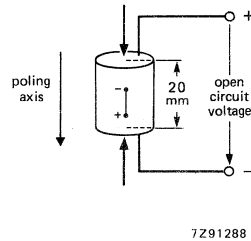
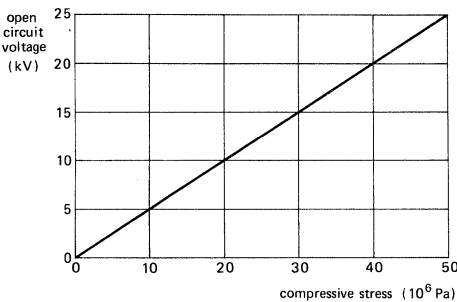

Fig. 4 Open circuit voltage of a 20 mm long piezoelectric ceramic cylinder as a function of compressive stress applied.

Figure 4 shows how the open-circuit voltage generated by a 20 mm long PXE cylinder varies with applied compressive stress. The figure shows that the voltage is directly proportional to the stress for applied stresses up to 50 000 kPa at which point the generated voltage equals 25 kV.

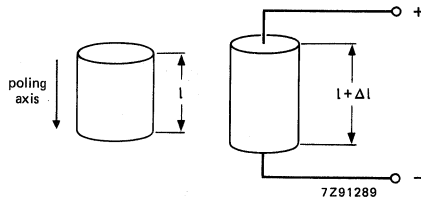

Fig. 5 Elongation of a cylindrical piezoelectric ceramic body caused by a d.c. voltage.

The maximum piezoelectric-induced strain,  $\Delta l/l$  (Fig. 5), in a PXE cylinder (PXE 5) is around  $1,6 \times 10^{-4}$  — corresponding to a maximum electric field strength of 450 V/mm. In a 20 mm cylinder, this would produce an extension of about  $3,3 \mu\text{m}$ . These figures relate only to the static strain. The dynamic behaviour of the cylinder will be quite different. At the frequency of mechanical resonance, for example, the maximum amplitude induced by an alternating field may be much greater than the  $3,3 \mu\text{m}$  maximum static displacement.

## PIEZOELECTRIC RELATIONSHIPS

### Direct piezoelectric effect

The electric dipole  $P$  developed in a piezoelectric ceramic medium by a tensile stress  $T$  parallel to its poling axis is given by

$$P = dT \quad (1)$$

in which  $d$  is a material constant known as the: piezoelectric voltage constant.  
(Note: for compressive stress, the sign of  $T$  is reversed).

In terms of the electric field  $E$  and electric displacement  $D$ , the polarization of a dielectric is

$$P = D - \epsilon E \quad (2)$$

in which  $\epsilon$  is the permittivity, itself a stress dependent quantity. To a first approximation, this dependence can be neglected and (1) and (2) combined to give  $dT = D - \epsilon^T E$ , or

$$D = dT + \epsilon^T E \quad (3)$$

where  $\epsilon^T$  is the permittivity at constant stress. This can also be written as

$$E = -gT + D/\epsilon^T \quad (4)$$

where  $g = d/\epsilon^T$  is known as the: piezoelectric charge constant.

### Inverse piezoelectric effect

In the absence of mechanical stresses, the strain  $S$  (i.e.  $\Delta l/l$ ) experienced by a piezoelectric ceramic medium when subject to an external electric field is given by

$$S = dE$$

or

$$S = gD.$$

The strain experienced by an elastic medium subject to a tensile stress  $T$  is according to Hooke's Law

$$S = sT$$

where  $s$  is the compliance of the medium.

Generally, however, the response of a stressed piezoelectric medium will be a complex interaction between both electrical and mechanical parameters. To a good approximation, the total strain  $S$  experienced by the medium is

$$S = s^E T + dE \quad (5)$$

or

$$S = s^D T + gD \quad (6)$$

in which  $s^E$  and  $s^D$  are respectively the specific compliances at constant electric field and constant electric displacement.

Note: in SI units,  $d$  is expressed in C/N (or its equivalent m/V), and  $g$  is expressed in Vm/N (or its equivalent m<sup>2</sup>/C).

**Coupling factor k**

From expressions (5) and (6),  $s^E$  and  $s^D$  are related by

$$s^D = [1 - k^2] s^E$$

with  $k = d^2/[s^E \epsilon^T]$  or  $k^2/[1 - k^2] = g^2 \epsilon^T/s^D$ .

Introduced this way, k is merely a convenient numerical quantity, but at frequencies well below the resonant frequency of the ceramic body, it has real physical meaning. Then

$$k^2 = \left[ \frac{\text{stored energy converted}}{\text{stored input energy}} \right]$$

k is referred to as the: coupling factor.

This formula holds for both electro-mechanical and mechano-electrical conversions. A study of the values of k in the *table of principal properties* shows that up to 50% of the stored energy can be converted at low frequencies. The values of  $k^2$  quoted in the table are the theoretical maxima. In practical transducers, the coupling factor is usually lower.

Although a high  $k^2$  is usually desirable for efficient transduction, it should not be thought of as an efficiency. Relations (3) to (6) take no account of dissipative mechanisms, and energy that is not converted can, in principle, still be recovered. For instance, in the case of electro-mechanical action, the unconverted energy remains as a charge in the capacitance of the PXE.

## DIRECTION DEPENDENCE

The discussions so far relate to uniaxial stress/electric-field conditions. Under more general conditions, the anisotropic nature of the piezoelectric material must be considered. This can be described in terms of the anisotropic properties of the piezoelectric and coupling constants, permittivity and compliance. To do this, it is necessary to define directional and shear axes.

For PXE ceramics, the direction of positive polarization is usually taken as that of the Z axis of a right-hand orthogonal crystallographic axial set X, Y, Z. Since PXE materials have complete rotational symmetry about the polar axis, the senses of X and Y chosen in an element are not important. If, as shown below, the X, Y and Z directions are represented by 1, 2 and 3 respectively, and the shear about these axis by 4, 5 and 6, the various related parameters can be written with subscripts referring to these.

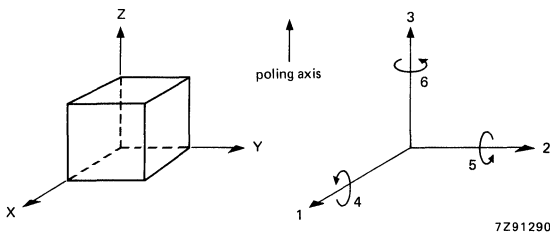

Fig. 6.

### Permittivity $\epsilon$

The first subscript gives the direction of the dielectric displacement, the second indicates the electric field direction. For example:

$\epsilon_{11}^T$  is the permittivity for dielectric displacement and electric field in the 1-direction under conditions of constant stress, and

$\epsilon_{33}^T$  is the permittivity for dielectric displacement and electric field in the 3-direction under conditions of constant stress.

The table of principal properties gives the relative permittivity, i.e.  $\epsilon/\epsilon_0$  ( $\epsilon$  is the absolute permittivity,  $\epsilon_0$  the permittivity of vacuum =  $8.85 \times 10^{-12}$  farad/metre).

### Compliance $s$ , modulus of elasticity $Y$ ( $= 1/s$ )

The first subscript refers to the direction of strain and the second gives the direction of stress. For example:

$s_{33}^E = 1/Y_{33}^E$  is the strain per unit stress in the 3-direction at constant electric field.

$s_{55}^D = 1/Y_{55}^D$  is the shear strain per unit shear stress about an axis perpendicular to the poling direction at constant electric displacement.

### Piezoelectric constants $d$ , $g$ and $k$

The first subscript refers to the electric field or displacement direction, and the second gives the direction of the mechanical stress or strain. For example:

$d_{33}$  is the induced strain per unit field in the 3-direction. Alternatively, it is the electric dipole per unit applied stress in the 3-direction.

$g_{31}$  is the electric field in the 3-direction per unit applied stress in the 1-direction. Alternatively, it is the induced strain in the 1-direction per unit dielectric displacement in 3-direction.



**Coupling factor k**

$k_{31}$  is the coupling factor between the stored mechanical energy input in the 1-direction and the stored electrical energy converted in the 3-direction (or vice versa).

**Special cases  $k_p$  and  $k_t$**

The planar coupling factor  $k_p$  of a thin disc denotes the coupling between the electric field in the 3-direction (thickness direction), and the simultaneous mechanical actions in the 1- and 2-directions which results in radial vibration (Fig. 7); hence the term radial coupling ( $k_r = k_p$ ).

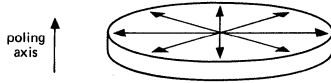

7291291

Fig. 7.

The thickness coupling factor  $k_t$  of a thin disc with arbitrary contour denotes the coupling between the electric field in the 3-direction (thickness direction) and the mechanical vibration in the 3-direction. This is smaller than  $k_{33}$  because of the constraint imposed by the large lateral dimensions of the disc relative to the thickness.

**Frequency constant N**

The frequency constant is the product of a resonant frequency and the linear dimension governing the resonance. For a 31, 15 or 33 mode resonance, and for planar or radial mode resonance, the relevant frequency constants are  $N_1$ ,  $N_5$ ,  $N_3$  and  $N_p$ .

Example: For a disc with diameter D and thickness d, the radial resonant frequency is:

$$f_{rad} = \frac{N_p}{D}$$

The thickness resonant frequency is:

$$f_{th} = \frac{N_p}{d}$$

The frequency constants are equal to half the governing sound velocity in the ceramic body, except for the constant  $N_p$ .

## DYNAMIC BEHAVIOUR

A piezoelectric transducer, operating near or at the mechanical resonant frequency can be characterized by the following simple equivalent circuit.

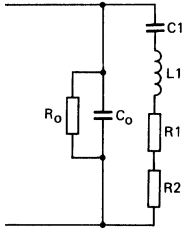

7Z91278

Fig. 8.

$C_0$  = capacitance of the clamped transducer.

$R_0$  = dielectric loss of the transducer  
 $[2\pi f (C_0 + C_1) \tan \delta]^{-1}$ .

$R_1$  represents the mechanical loss in the transducer.

$R_L$  represents the acoustic or mechanical load.

$C_1$  and  $L_1$  represent the rigidity and the mass of the material.

If the electrical admittance ( $Y$ ) of the vibrating transducer is plotted against the frequency, one obtains the following resonant curve. (Fig. 9).

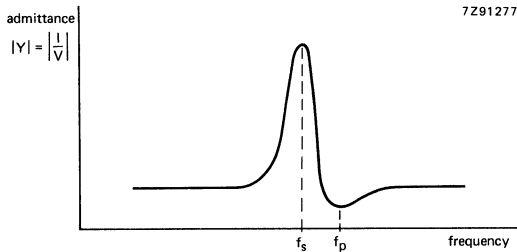

Fig. 9.

The frequency  $f_s$ , at which the admittance is maximum, is called the series resonant frequency. The minimum value of the admittance is found at the parallel resonant frequency  $f_p$ .











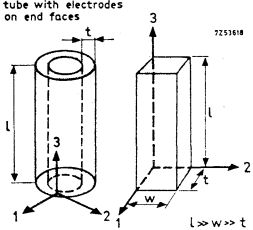

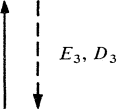
## DEPOLARIZATION



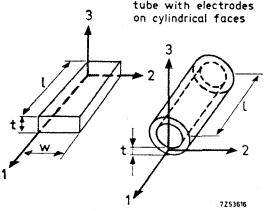

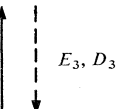

The polarization (poling) of piezoelectric materials is permanent. However, when working with these materials, the following points should be borne in mind:

- (1) The temperature of the material should be kept well below the Curie point.
- (2) The material should not be exposed to very strong alternating electric fields or direct fields, opposing the direction of poling.
- (3) Mechanical stress, exercised on the material, should not exceed specified limits.

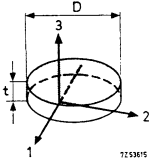
Failure to comply with these three conditions may result in depolarization (depoling) of the material so that the piezoelectric properties become less pronounced or disappear completely.

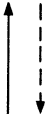
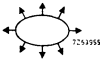
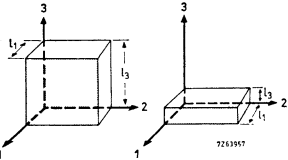
## MODES OF VIBRATION

resonant element with electrodes	biasing polarization	a.c. field and polarization	main component of a.c. stress and strain	conditions satisfied	pertinent coupling factor and frequency constant vibrational mode
 <p>tube with electrodes on end faces 7251618</p>		 <p><math>E_3, D_3</math></p>	 <p><math>T_3, S_3</math></p> <p>(axial direction in tube)</p>	$S_1 = S_2 = 0$ $T_1 = T_2 = 0$	$(k_{33})T_1T_2 = k_{33}$ $(N_3^E)T_1T_2 = N_3 = f_1l$ length mode with parallel excitation
			<p>parallelepiped</p>  <p><math>T_1, S_1</math></p> <p>tube  <math>T</math> and <math>S</math>            in radial direction</p>  <p>7263954</p>	$S_2 = S_3 = 0$ $T_2 = T_3 = 0$	$(k_{31})S_2S_3 = k_{31}^*$ $(N_1^E)S_2S_3 = N_1^* = f_r t$ thickness mode with transverse excitation
 <p>tube with electrodes on cylindrical faces 7253006</p>		 <p><math>E_3, D_3</math></p>	 <p>7263954</p> <p>tube  <math>T</math> and <math>S</math>            in radial direction</p> <p>parallelepiped</p>  <p><math>T_3, S_3</math></p>	$S_1 = S_2 = 0$ $T_1 = T_3 = 0$	$(k_{33})S_1S_2 = k_r$ $(N_3^E)S_1S_2 = N_r = f_r t$ thickness mode with parallel excitation
			 <p><math>T_1, S_1</math></p> <p>(axial direction in tube)</p>	$S_2 = S_3 = 0$ $T_2 = T_3 = 0$	$(k_{31})T_2T_3 = k_{31}$ $(N_1^E)T_2T_3 = N_1 = f_1l$ length mode with transverse excitation

		 $E_3, D_3$	 $T_1, S_1$  (radial direction) (also $T_2, S_2$ in circular direction)	$S_3 = 0$ $T_3 = 0$	$k_{31} \sqrt{2/(1-\sigma)} = k_p$ $N_p^E = N_p = P_r D$ planar mode with transverse excitation
		 $E_1, D_1$	shear in 31-plane  $T_5, S_5$  	propagation of shear waves in 1-direction if $l_1 = t \ll l_3$ , in 3-direction if $l_3 = t \ll l_1$	$k_5$ $N_5^E = N_5 = f_r t$ thickness shear mode thickness $t$ being $l_1$ or $l_3$ whichever is smaller



## MATERIALS AND GRADES

The following grades are available:

**PXE 5:** This material combines a high coupling coefficient and high piezoelectric charge constant. It is ideally suited for low-power applications. Among these are numerous non-resonant applications such as pick-up elements, fine movement control, feedback plates, microphones, pressure and acceleration sensors, and hydrophones. PXE 5 can also be used for low-power resonant applications (e.g. air transducers for remote control purposes). This grade has an excellent time stability characteristics, and a high electrical resistivity at high temperatures.

**PXE 21:** A grade which has been developed for ignition purposes. It has a high voltage constant which ensures a high voltage output. This material is suitable for impact mechanisms used for the ignition of gases and explosives.

**PXE 41:** A low loss-material for medium power applications. In particular, the high mechanical quality factor and low loss factor (even at intensive drive) make PXE 41 suitable for high power ultrasound applications at medium range temperatures and pre-stresses. Furthermore, PXE 41 can be exposed to high repetitive quasi-static loads and dynamic loads for ignition purposes.

**PXE 42:** A low loss material for high power applications. Its low dielectric loss and high mechanical quality factor, combined with a tolerance of high temperature and mechanical stress, make it particularly suitable for the generation of ultrasonic power. It is the recommended material for ultrasonic cleaning.

**PXE 43:** A low loss material for high power applications. Its low dielectric loss and high mechanical quality factor, combined with a very good behaviour at high electric fields and increased temperatures, make it suitable for ultrasonic welding.

**PXE 52:** A material with a higher permittivity and a higher charge constant than PXE 5. Due to its lower Curie point it also has a lower temperature stability. The material is suitable for sensitive detection-tone generation and for fine movement control applications.

**PXE 71:** A grade with moderate permittivity and high temperature stability as well as a high shear coupling coefficient. Ageing of the permittivity of this material, and hence phase distortion of the electrical resonance circuit, is extremely low; it is therefore suitable for h.f. shear resonance applications where phase is important, e.g. in ultrasonic delay lines for colour television receivers.

PRINCIPAL PROPERTIES

The following grades, consisting of modified lead zirconate titanates are distinguished according to their electrical and mechanical properties and field of application. Unless otherwise stated, the specified values are measured at  $20 \pm 5 \text{ }^\circ\text{C}$ , 24 h after poling.

property and symbol	unit	PXE 5	PXE 52	
<b>thermal data</b>				
Curie temperature	$^\circ\text{C}$	285	165	
specific heat	J/kg K	420	420	
thermal conductivity	W/m K	1,2	1,2	
<b>mechanical data</b>				
density $\rho_m$	$10^3 \text{ kg/m}^3$	7,7	7,8	
compliance $\left\{ \begin{matrix} s_{33}^E \\ s_{11}^E \\ s_{55}^E \end{matrix} \right\}$	$10^{-12} / \text{Pa}$	18 15 38,5	20 16	
Poisson's ratio $\sigma$		$\approx 0,3$	0,3	
mechanical quality factor for radial mode $Q_m^E$		$\approx 80$	$\approx 65$	
frequency constants $\left\{ \begin{matrix} N_P^E \\ N_D^E = \frac{1}{2} \nu_{33}^D \\ N_T^E = \frac{1}{2} \nu_{11}^T \\ N_S^E = \frac{1}{2} \nu_{55}^S \end{matrix} \right\}$	Hz m	2000 1850	1950 1900	
	or	1450	1400	
compressive strength	m/s	930		
tensile strength	$10^6 \text{ Pa}$	$> 600$ $\approx 80$	$> 600$ $\approx 80$	
<b>electrical data</b>				
relative permittivity $\left\{ \begin{matrix} \epsilon_{33}^T / \epsilon_0 \\ \epsilon_{11}^T / \epsilon_0 \end{matrix} \right\}$ ( $\epsilon_0 = 8,85 \cdot 10^{-12} \text{ F/m}$ )		2000 1800	3500 3000	
resistivity $\rho_{el}$ ( $25 \text{ }^\circ\text{C}$ )	$10^{12} \text{ } \Omega\text{m}$	1		
time constant $\rho_{el} \epsilon_{33}^T$ ( $25 \text{ }^\circ\text{C}$ )	min	$> 300$	$> 500$	
dielectric loss factor $\tan \delta$	$10^{-3}$	20	16	
<b>electro-mechanical data</b>				
coupling factor $\left\{ \begin{matrix} k_p \\ k_{33} \\ k_{31} \\ k_{15} \end{matrix} \right\}$		0,63 0,69 0,37 0,66	0,65 0,74 0,39	
	piezoelectric charge constants $\left\{ \begin{matrix} d_{33} \\ d_{31} \\ d_{15} \end{matrix} \right\}$	$10^{-12} \text{ C/N}$	390	580
		or	-190	-270
	piezoelectric voltage constants $\left\{ \begin{matrix} g_{33} \\ g_{31} \\ g_{15} \end{matrix} \right\}$	m/V	515	
$10^{-3} \text{ Vm/N}$		22,0	19	
or		-10,9	-8,7	
	$\text{m}^2 / \text{C}$	32,5		
<b>time stability</b>				
coupling factor $k_p$ permittivity $\epsilon_{33}^T$ frequency constant $N_P^E$ quality factor $Q_m^E$ dielectric loss factor $\tan \delta$	relative change per time decade (%)	-0,5	-0,6	
		-1,0	-1,0	
		0,5	0,3	
			-3	

The properties of components manufactured from PXE are dependent on the dimensions of the product and method of manufacture, and also on the measuring level. Therefore a meaningful interpretation of the properties of the material is best done in consultation with the supplier.

PXE 21	PXE 41	PXE 42	PXE 43	PXE 71
270	315	325	300	270
420	420	420	420	420
1,2	1,2	1,2	1,2	1,2
7,75	7,90	7,70	7,70	7,75
18,6	14,6	15,3	12,6	—
15,1	12,2	12,7	11,3	15,0
	37,0			38,0
≈ 0,3	≈ 0,3	≈ 0,3	0,3	≈ 0,3
≈ 80	≈ 1000	≈ 750	1000	≈ 80
2000	2200	2200	2350	2050
1900	2000	2015	2050	—
	1620			1500
	950			920
> 600	> 600	> 600	> 600	> 600
≈ 80	≈ 80	≈ 80	≈ 80	≈ 80
1750	1200	1300	1000	1300
	1400			1700
0,1	0,05			1
> 25	> 7			> 250
18	2,5	2,5	2	20
0,62	0,58	0,58	0,50	0,60
0,72	0,68	0,68	0,63	—
0,37	0,34	0,34	0,30	0,35
	0,70			0,66
385	268	285	210	—
— 180	— 119	— 130	— 95	— 147
	480			500
25,0	25,2	25,0	25,0	—
— 11,6	— 11,6	— 11,0	— 10,7	— 12,8
	38,5			33,2
— 1,5	— 1,5	— 2,5	— 2	— 0,5
— 2	1	— 6,0	— 4,5	— 0,5
0,5	0,5	1,5	1	0,5
	10			
	— 10			



## APPLICATIONS

High voltage generators (for ignition purposes):	gas appliances, cigarette lighters, fuzes for explosives, flash bulbs.
High power ultrasonic generators:	ultrasonic cleaning for industrial and domestic appliances, sonar, echo sounding, ultrasonic welding of plastics and metals, ultrasonic drilling and machining of brittle materials, ultrasonic soldering, atomization.
Transducers for sound and ultrasound in air:	microphones e.g. for telephones, intruder alarm systems, remote control, loudspeakers, e.g. tweeters, audio tone generators in signalling devices.
Pick-ups and sensors:	record players, accelerometers, detection systems in machinery, e.g. textile, medical equipment, motor cars, e.g. knock sensor.
Resonators and filters:	radio, television, telecommunications.
Delay lines:	colour television.
Push buttons and keyboards:	teleprinters, desk calculators and electronic computers, slot machines, telephones.
Miscellaneous:	ink jet printers, fine movement control, flow meters.

## CONNECTION

An electrical contact may be made by soldering bonding or clamping wires to the electrodes which can be metallized in silver or nickel.

### SOLDERING

The electrode surface should be free from grease and dust. If tarnished, the silver should be lightly cleaned. Suggested soldering prescription:

- soldering iron: standard 25 to 50 W type with copper bit,
- soldering iron temperature: 250 to 300 °C for silver electrodes and 400 °C for nickel electrodes,
- preferred solder: Sn/Pb 60/40, with slightly activated resin,\*
- soldering time:  $3 \pm 1$  s,
- standard wire diameter: 0,3 mm or fine stranded flex.

The soldering time should be kept as short as possible; otherwise the disc or plate may be partly depolarized (to an extent depending on temperature and time).

\* e.g. "Fluitin", SnPb 60/1532  
or "Billiton", SnPb 60/RS4  
or "Multicore", SnPb 60/366.

## QUALITY ASPECTS

The production batches of our piezoelectric ceramic products are inspected for mechanical, electrical and visual properties. The quality of the products is in conformity with MIL-STD-105D.

A. Q. L. values are laid down as follows:

inspection	A.Q.L.	inspection level
mechanical	1	I
electrical	0,65	II
visual	1	I

Mechanical and visual inspections follow normal procedures, electrical inspection methods are laid down in I.R.E. standards on piezoelectric products.

For special applications, special requirements on the products are necessary: it is advised that the specification be determined in co-operation with the supplier.

## STABILITY

The properties of piezoelectric elements are more or less temperature and time dependent. The stability, as a function of time, is of particular interest. Fortunately the poling ages approximately logarithmically (Figs 10 and 11), so that the rate of change in permittivity, coupling factor, frequency constant, and so on, reduces rapidly in the course of time. Powerful ambient influences are likely to change the original ageing pattern. This applies particularly to the permittivity, the mechanical quality factor, and the dielectric loss factor,  $\tan \delta$ .

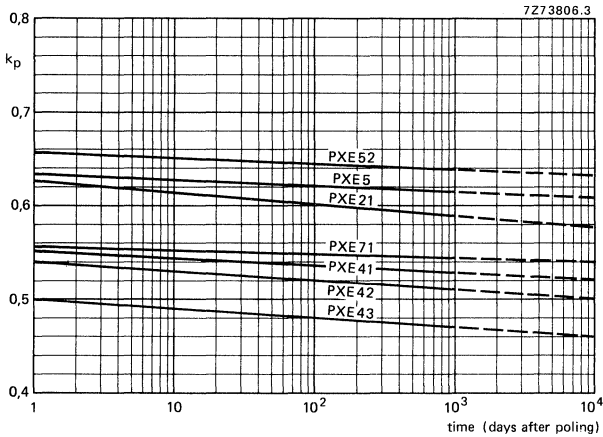

Fig. 10.

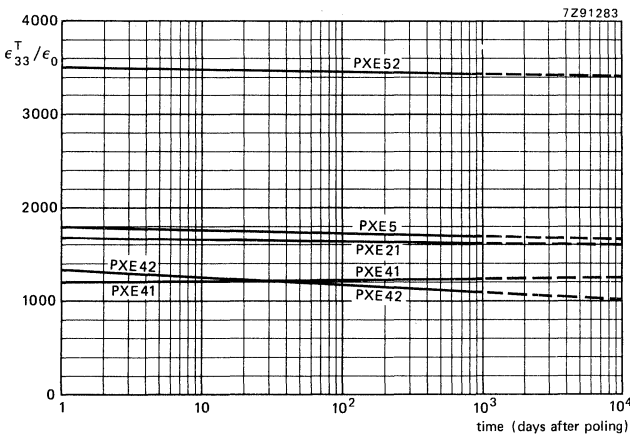
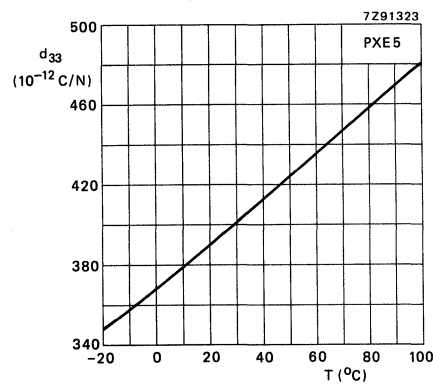
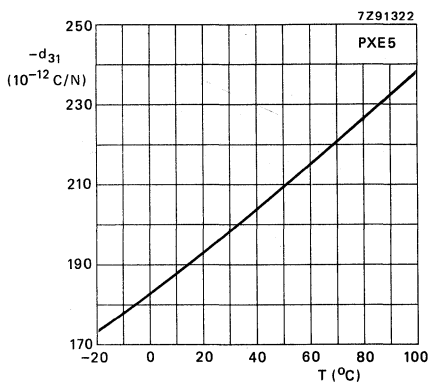
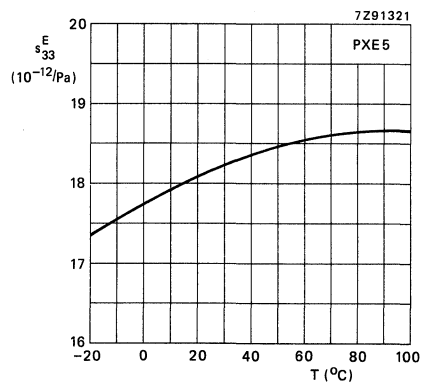
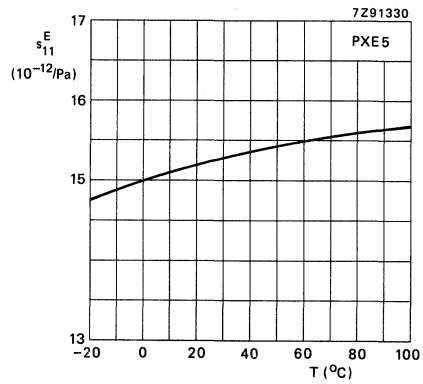
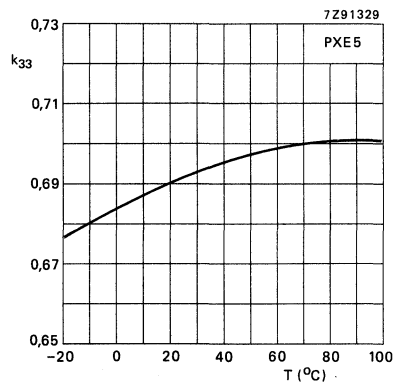
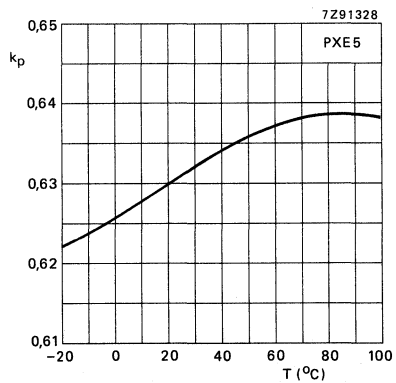
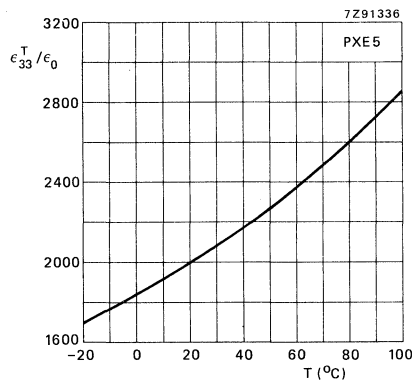
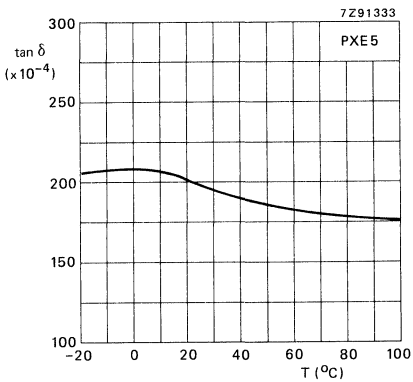
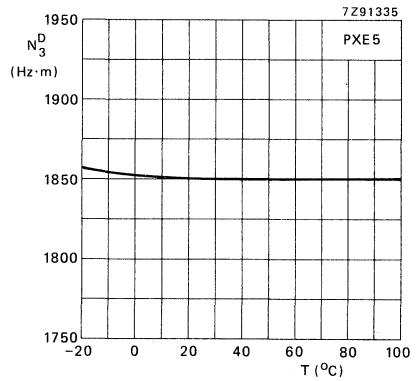
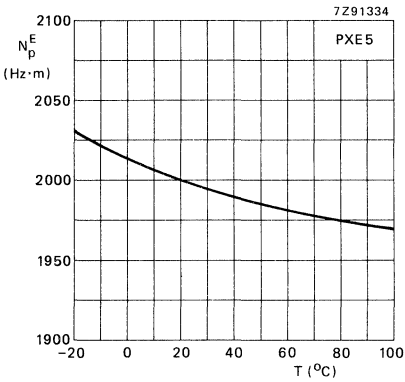
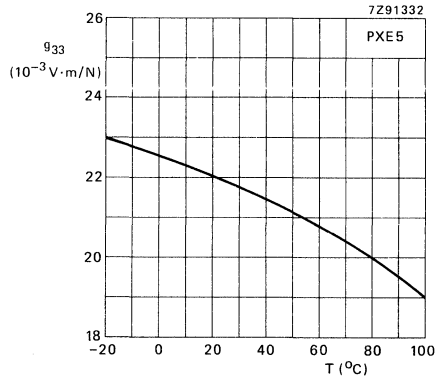
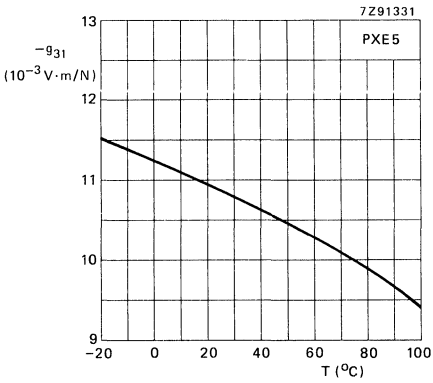

Fig. 11.

# TEMPERATURE EFFECTS

## PXE 5





TEMPERATURE EFFECTS

PXE 21

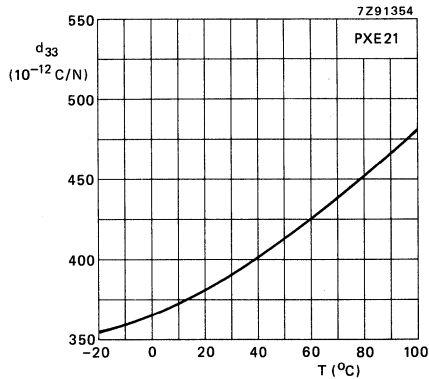
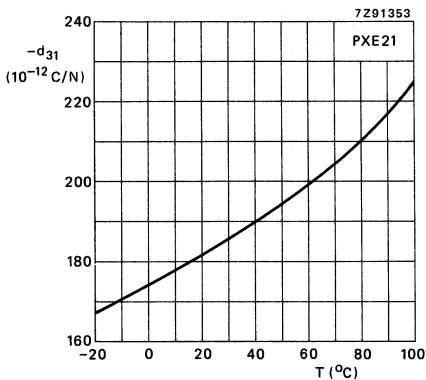
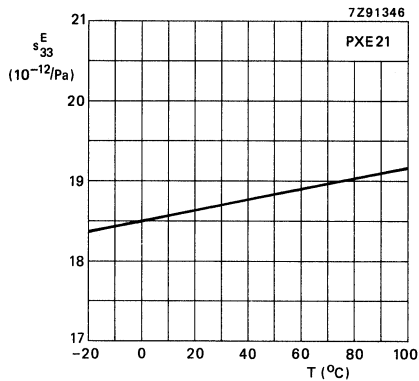
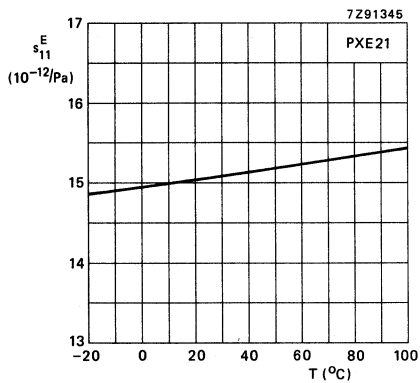
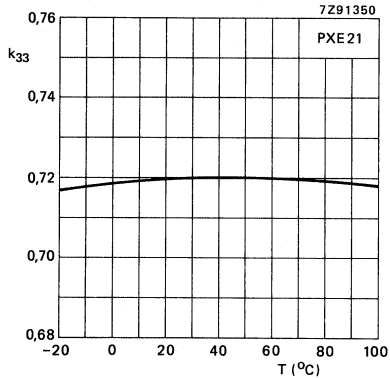
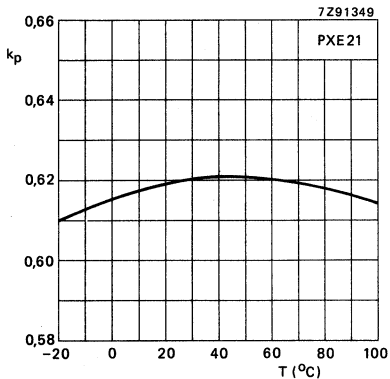

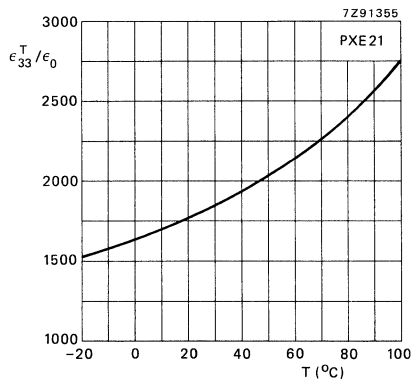
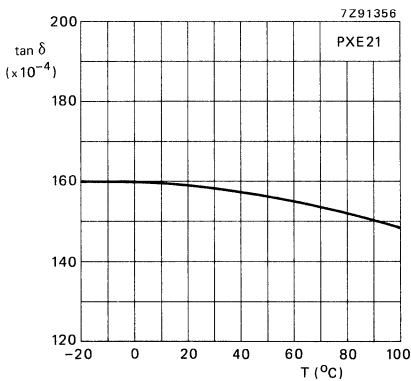
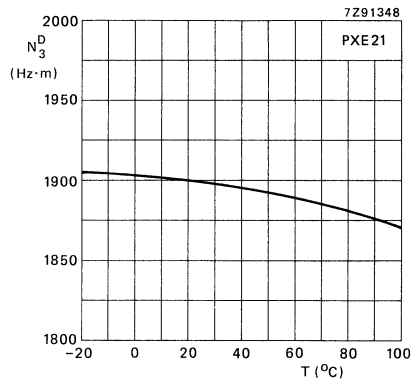
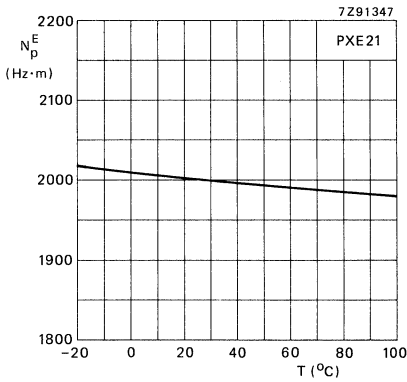
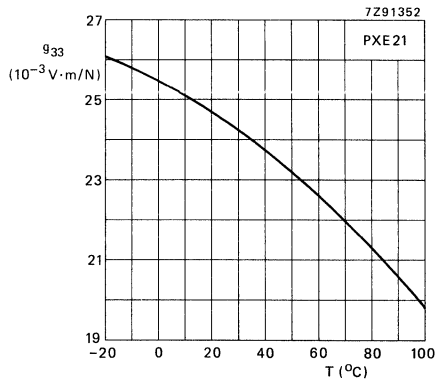
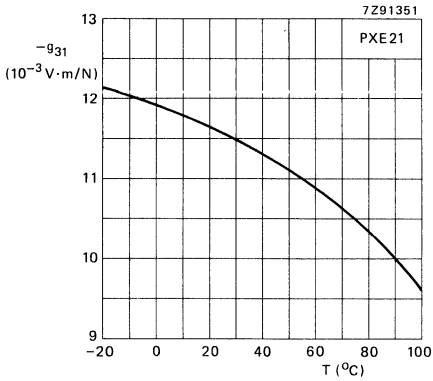



TEMPERATURE EFFECTS

PXE 41

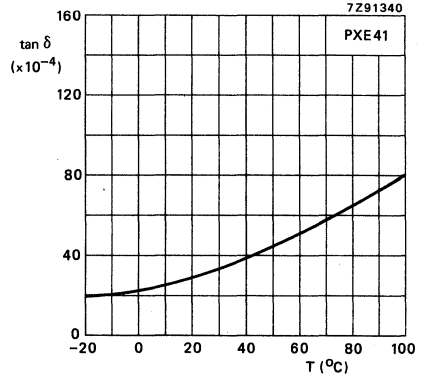
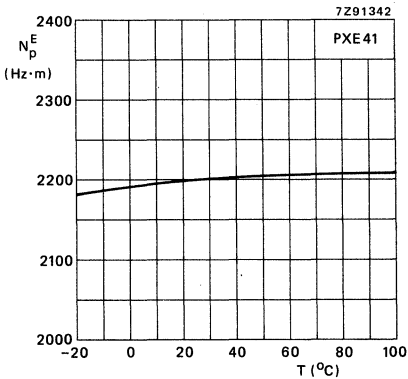
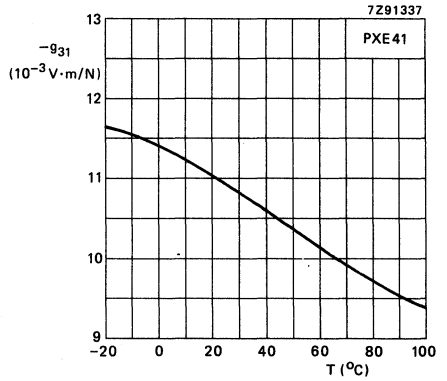
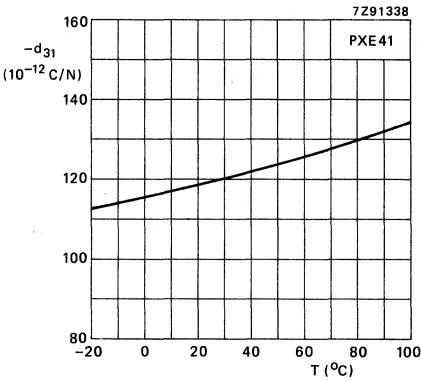
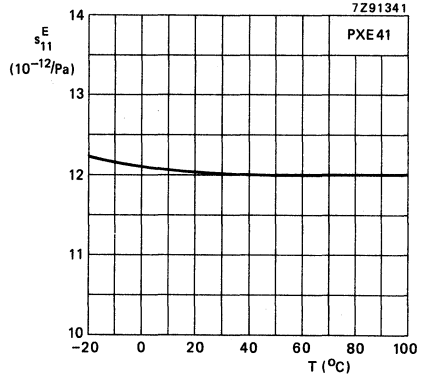
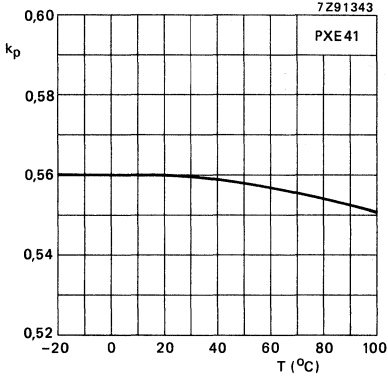

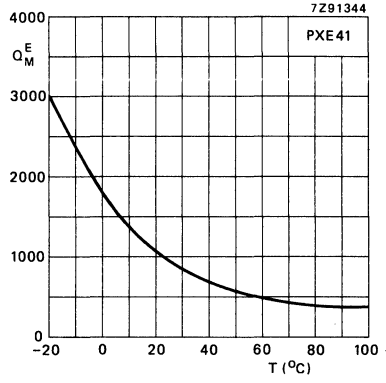
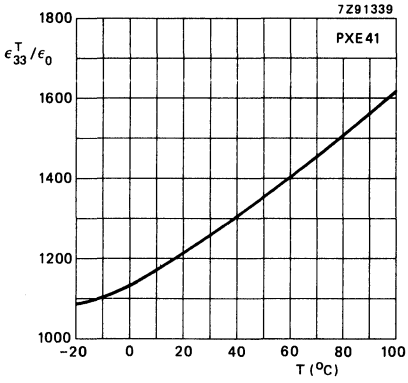

TEMPERATURE EFFECTS

PXE 52

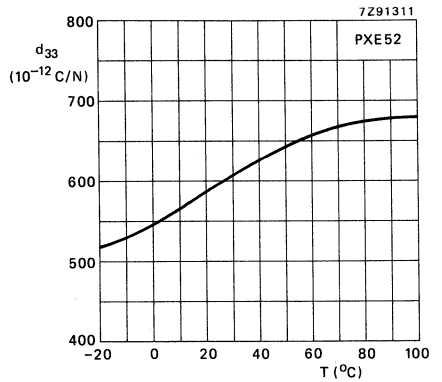
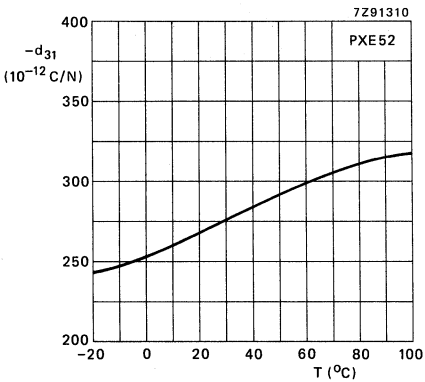
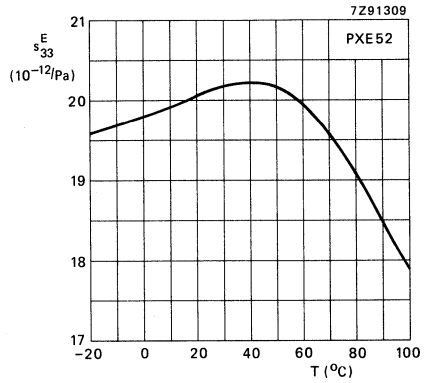
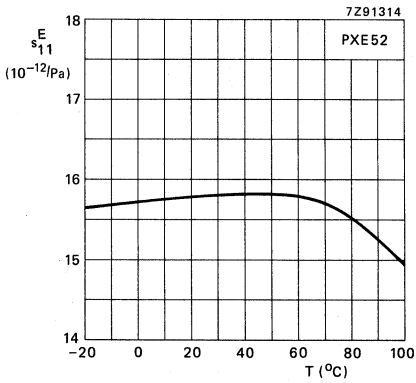
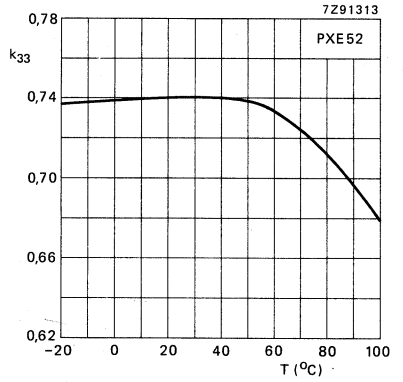
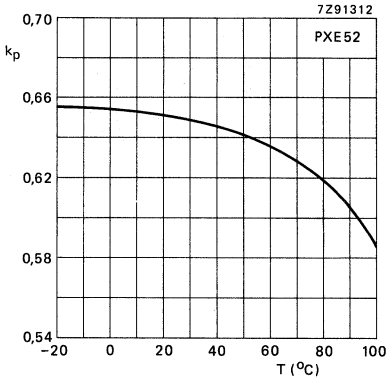

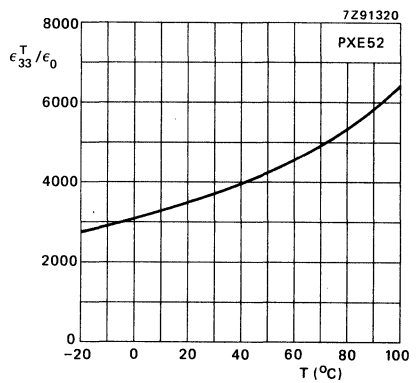
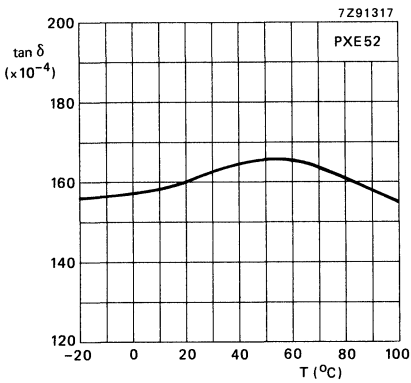
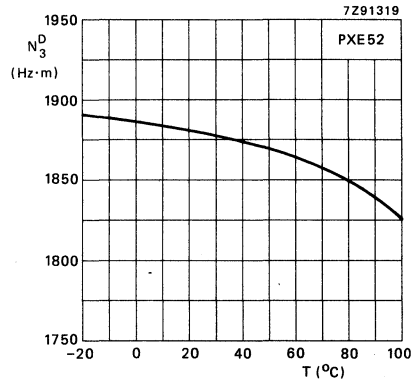
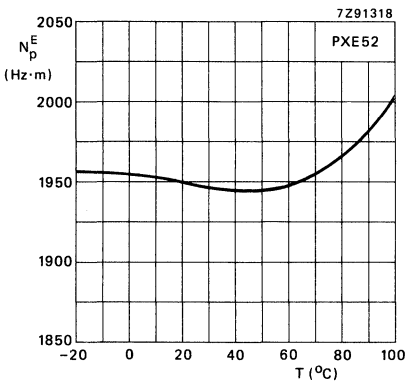
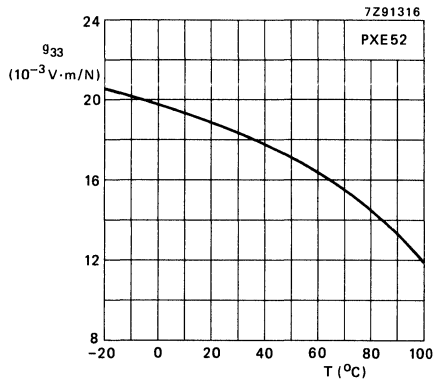
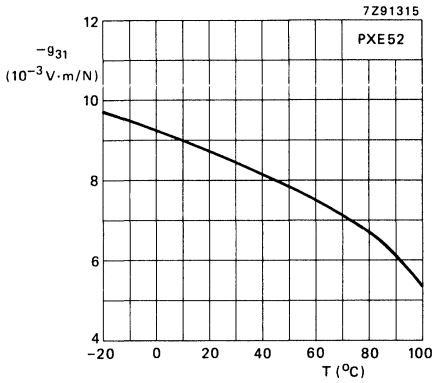

## DISCS AND PLATES

### DISCS with nickel plated electrodes

PXE discs can be used in a great number of applications. Electrical contact may be made by soldering wires to the electrodes. The grade is PXE 5, but other grades and sizes may be asked for. A non-metallized edge of 0,5 mm is allowed for 10-16-20 and 25 mm dia. The positive pole is marked.

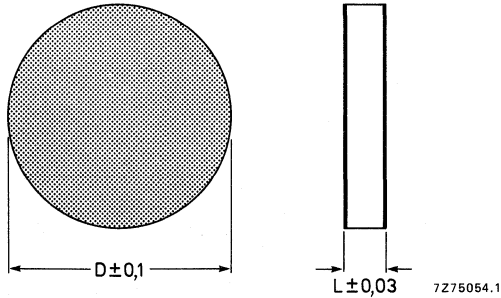

Material: PXE 5

D mm	L mm	catalogue number
5,0	0,3	4322 020 17500
5,0	0,5	17510
5,0	1,0	17520
5,0	2,0	17530
10,0	0,2	4322 020 17540
10,0	0,5	17550
10,0	1,0	17560
10,0	2,0	17570
10,0	3,0	17580
10,0	5,0	17590
16,0	0,2	4322 020 17600
16,0	0,5	17610
16,0	1,0	17620
16,0	2,0	17630
16,0	3,0	17640
20,0	0,2	4322 020 17650
20,0	0,5	17660
20 0	1,0	17670
20,0	2,0	17680
25,0	0,2	4322 020 17690
25,0	0,5	17700
25,0	1,0	17710
25,0	2,0	17720

**PLATES with nickel plated electrode**

→ Square and rectangular plates. Electrical contact may be made by soldering wires to the electrodes. The material grade is PXE 5, but other grades and sizes with thickness of 0,25 to 1,0 mm may be asked for. The positive pole is marked.

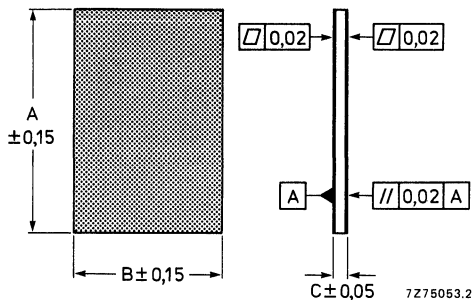

Material: PXE 5

$k_{31} \geq 0,30$

A mm	B mm	C mm	catalogue number
4	4	0,3	4322 020 13500
8	4	0,3	13520
12	4	0,3	13540
6	6	0,3	13550
12	6	0,3	13580
8	8	0,3	13590
10	10	0,3	13620
12	12	0,3	13640
12	6	0,5	13650
12	6	1,0	13660

**DISCS AND PLATES for one side connection**

These devices have provision for connecting both electrodes from one side by means of a wrap-round electrode as shown below; they are therefore particularly suitable for bonding to flat substrates where electrical connection to both sides is difficult. The electrodes are silver.

**DISC**

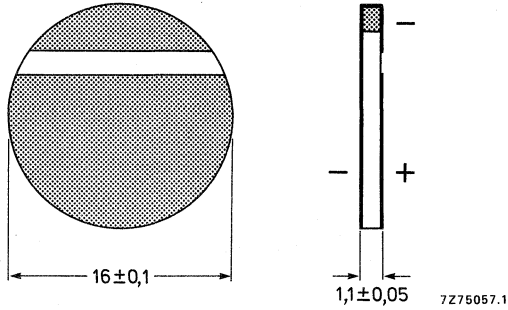

Material:	PXE 5
Effective coupling factor $k_{\text{eff}}$ :	$\geq 0,30$
Catalogue number:	4322 020 02270

**DISCS for audio applications, acoustic elements**

For use in devices such as clocks and watches, smoke alarm devices, audio alarms, telephone/microphone, small loudspeakers and tweeters.

Available in 2-electrode- or 3-electrode version.

Electrodes are nickel, solderable.

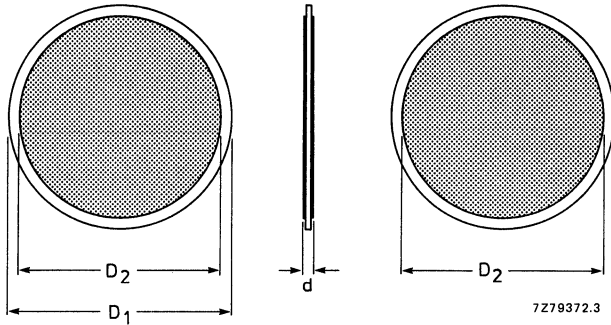

Two electrode configuration.

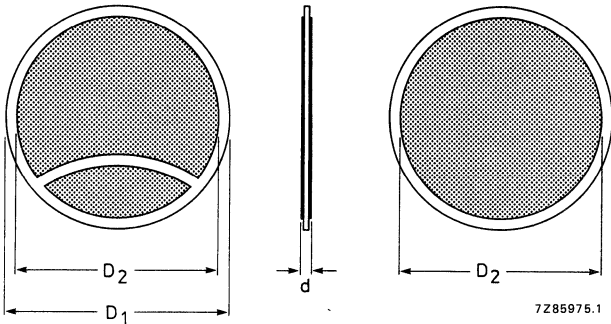

Three electrode configuration.

Material grade: PXE 52

D <sub>1</sub> mm	D <sub>2</sub> mm	d mm	2-electrodes catalogue no.	3-electrodes catalogue no.
10	9	0,11	4322 020 17730	
16	15	0,15	17740	4322 020 17770
20	19	0,15	17750	17780
25	24	0,15	17760	17790

These discs are supplied **not poled**. They are to be poled after glueing with  $400 \pm 20$  V (d.c.) during 2 s in air with a series resistor of 100 k $\Omega$ .



**DISCS glued on nickel plated membrane for buzzers; acoustic elements**

Available in 2-electrode or 3-electrode version

Electrodes are **nickel**, solderable.

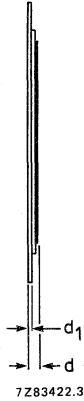
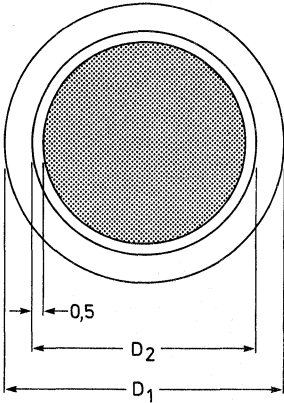

Two electrode configuration.

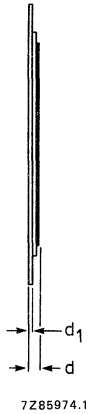
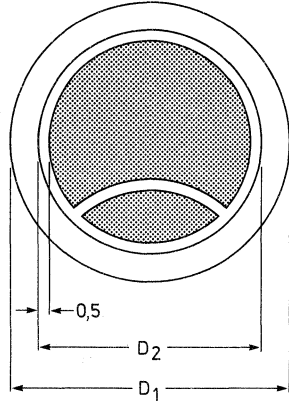

Three electrode configuration.

Material: PXE 52

D <sub>1</sub> mm	D <sub>2</sub> mm	d <sub>1</sub> mm	d mm	2 electrodes catalogue no.	3 electrodes catalogue no.
12,5	10	0,1	0,3	4322 020 16320	—
20	16	0,15	0,4	16330	4322 020 16390
27	20	0,15	0,4	16340	16400
35	25	0,15	0,4	16350	16410
43	25	0,15	0,4	16360	—
46	25	0,15	0,4	16370	—
50	25	0,15	0,4	16380	—

**DISCS glued on nickel plated membrane for buzzers Not for new designs.**

Available in 2-electrode or 3-electrode version.

Electrodes are silver.\*

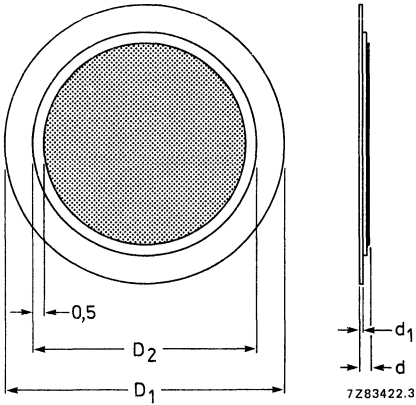

Two electrode configuration.

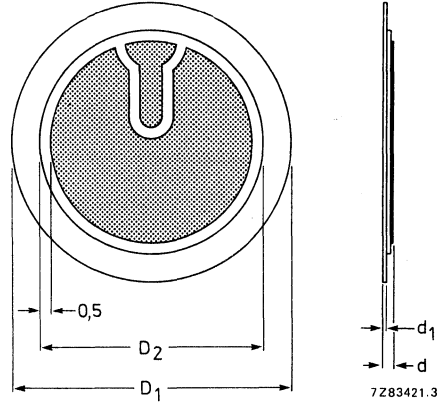

Three electrode configuration.

Material: PXE 52

D <sub>1</sub> mm	D <sub>2</sub> mm	d <sub>1</sub> mm	d mm	2 electrodes catalogue no.	3 electrodes catalogue no.
20	16	0,2	0,5	4322 020 08820	4322 020 08870
27	20	0,2	0,5	08840	08880
35	25	0,2	0,5	08850	08890

\* See data on preferred types with nickel electrodes.

**TWEETER MEMBRANE**

For high frequency tweeter loudspeakers.

Available with or without leads. The electrodes are either silver or nickel plated (preferred). The positive pole is marked.

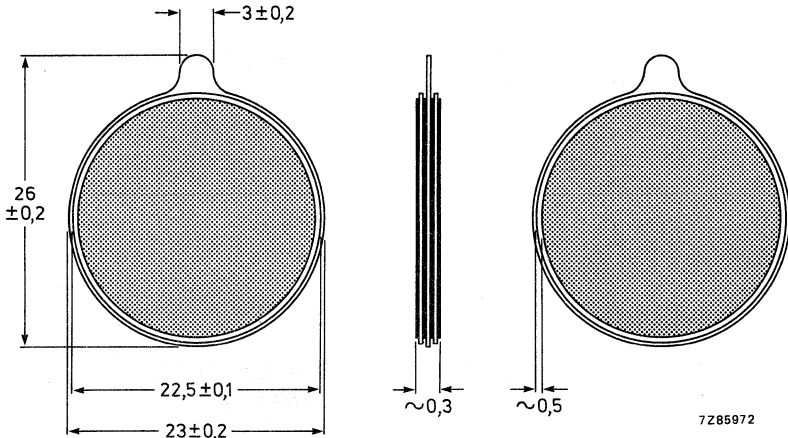

Fig. 1 Without leads.

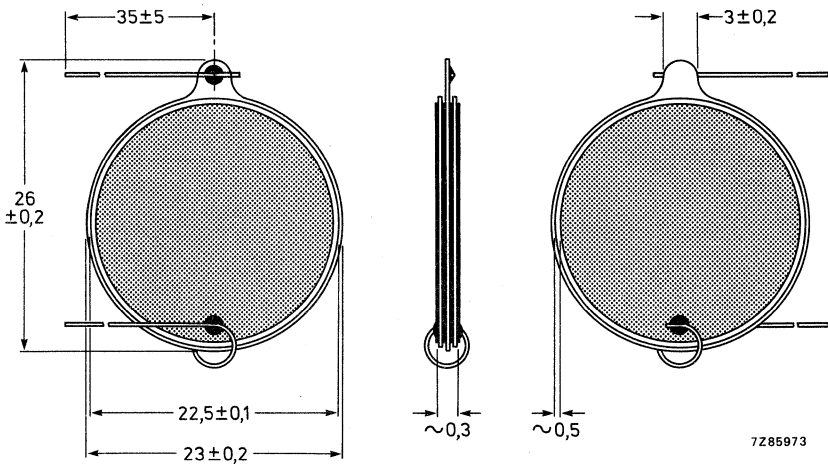

Fig. 2 With leads.

Material: PXE 52

	without leads catalogue no.	with leads catalogue no.
silver electrodes	4322 020 08990	4322 020 16490
nickel electrodes	4322 020 16470	4322 020 16480

## ACTUATORS

Operating in the 31 or 33 mode below the resonant frequency, actuators transfer electrical energy into "large" displacements in comparison with the displacements of simple PXE transducers.

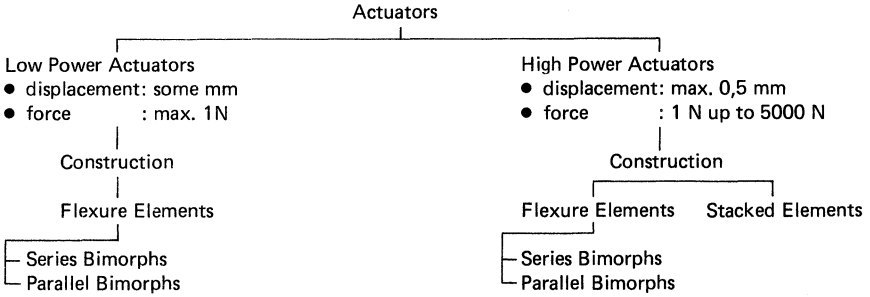



## PXE FLEXURE ELEMENTS: BIMORPH

Many applications require displacements far greater than are possible with simple PXE transducers operating in the 31 or 33 modes. Moreover, the voltages required to produce these displacements are very high, and because they present a considerable mismatch to air, these elements are unsuitable for use as electro-acoustic transducers.

A much more compliant structure operating in the 31 mode is the flexure element, the simplest form of which is the bilaminar cantilever or *bimorph*. This consists of two thin PXE strips bonded together. Bimorphs are usually mounted as a cantilever and usually operate in the 31 mode (see Figs 1 and 2).

A *series bimorph* is one whose PXE strips are connected to the voltage source in series (Fig. 1), and a *parallel bimorph* is one whose strips are individually connected to the voltage source (Fig. 2).

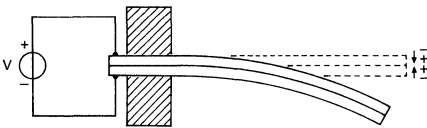

7Z91280

Fig. 1 Series bimorph.

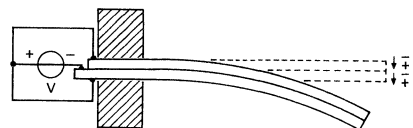

7Z91281

Fig. 2 Parallel bimorph.

In the series bimorph, one of the PXE strips will always be subject to a voltage opposite to the polarizing voltage, so there is always a danger of depolarization. This is also true of the parallel bimorph configuration of Fig. 2, but if it is connected as shown in Fig. 3, both strips will be driven in the polarization direction, thereby avoiding drift in characteristics caused by depolarization.

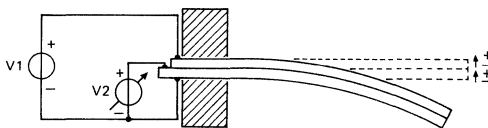

$V_2 \leq V_1$

7Z91282

Fig. 3.

PRACTICAL DESIGN DATA

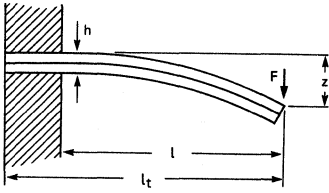

- $l_t$  = total length
- F = force on tip
- W = width
- l = free length
- h = total thickness
- z = deflection of tip
- Field strength: max. 500 V/mm

7291279

	parallel	series
deflection (m/V)	$9 \cdot 10^{-10} \frac{l^2}{h^2}$	$4,5 \cdot 10^{-10} \frac{l^2}{h^2}$
bending (m/N)	$7 \cdot 10^{-11} \frac{l^3}{Wh^3}$	$7 \cdot 10^{-11} \frac{l^3}{W \cdot h^3}$
resonance frequency (Hz)	$400 \frac{h}{l^2}$	$400 \frac{h}{l^2}$
charge output (C/N)	$8 \cdot 10^{-10} \frac{l^2}{h^2}$	$4 \cdot 10^{-10} \frac{l^2}{h^2}$
capacitance (F)	$8 \cdot 10^{-8} \frac{l_t W}{h}$	$2 \cdot 10^{-8} \frac{l_t W}{h}$
voltage output (V/N)	$10^{-2} \frac{l^2}{h l_t W}$	$2 \cdot 10^{-2} \frac{l^2}{h l_t W}$

## SERIES BIMORPH PLATES

A range of square and rectangular plates in grade PXE 5 for use in record players, accelerometers, detection systems in machinery, medical equipment and air transducers. The electrodes are nickel plated and are solderable.

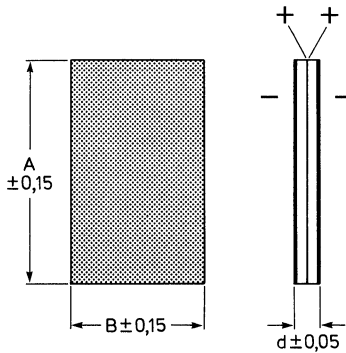

7285971

Material: PXE 5

A mm	B mm	d mm	catalogue number
4	4	0,6	4322 020 04570
6	4	0,6	04580
8	4	0,6	04590
10	4	0,6	04600
12	4	0,6	04610
6	6	0,6	04620
8	6	0,6	04630
10	6	0,6	04640
12	6	0,6	04650
8	8	0,6	04660
10	8	0,6	04670
12	8	0,6	04680
10	10	0,6	04690
12	10	0,6	04700
12	12	0,6	04710
12,7	1,6	0,6	08250
15,5	1,6	0,6	08240
70	1,6	0,6	08230

Other sizes on request.



### PARALLEL BIMORPH PLATE

This plate is used for dynamic track sensing in VCR2000 equipment. It consists of two polarized plates bonded together to a parallel bimorph plate. The electrodes are nickel plated and can be soldered.

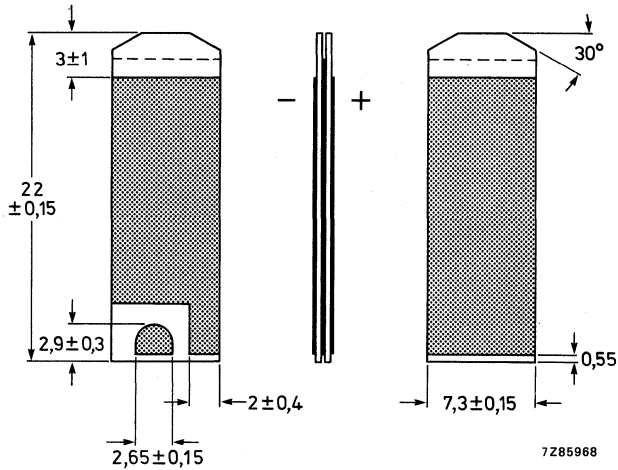

Material	PXE 5
Catalogue number	4322 020 07590
Resonant frequency	$900 \text{ Hz} < f_s < 1300 \text{ Hz}$
Deflection	measured at 25 to 100 Hz with 300 V (peak to peak), free length 15,2 mm, 215 to 280 $\mu\text{m}$ (peak to peak)

## PARALLEL BIMORPH PLATES

A range of rectangular parallel bimorph plates in grade PXE 5 of which the inner electrode is executed as a wrap-round. The electrodes are nickel plated and are solderable.

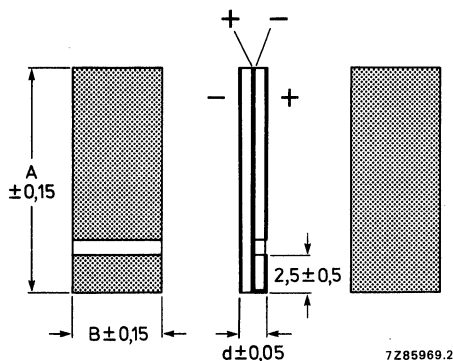

Material: PXE 5

A mm	B mm	d mm	catalogue number
15	6	0,6	4322 020 14530
20	6	0,6	14540
25	6	0,6	14550
30	6	0,6	14560
35	6	0,6	14570
15	12	0,6	14580
20	12	0,6	14590
25	12	0,6	14600
30	12	0,6	14610
35	12	0,6	14620

Other sizes on request.

## HIGH-POWER ACTUATOR

The high-power actuator produces in the 33 mode displacements far greater than those possible with simple PXE transducers operating in the 31 or 33 modes. It comprises a pile of PXE discs, held in compression with a force of about 1000 N by a cylindrical steel spring and interleaved with copper foil electrodes. The high compressive forces give the structure exceptional rigidity by eliminating all free play between the discs.

A voltage between the electrodes causes the discs to expand, stretching the cylindrical spring and producing an overall extension of the actuator. The actuator has a response time of around 200  $\mu$ s.

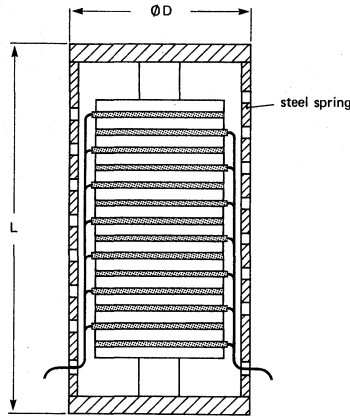

7291285

catalogue number	4322 020 19050	4322 020 19060	4322 020 19070	
→ Dimensions D x L	16 x 50	22 x 75	32 x 100	mm
Stroke 0 to 500 V	~ 20	~ 30	~ 50	$\mu$ m
Stroke 0 to 800 V	~ 35	~ 50	~ 80	$\mu$ m
Capacitance at 25 °C	~ 100	~ 250	~ 800	nF
Stiffness	~ 30	~ 50	~ 80	N/ $\mu$ m
Max. applied force	2000	3000	5000	N

## PIEZOELECTRIC CERAMICS FOR ULTRASONIC TRANSDUCERS

### INTRODUCTION

PXE, usually in the form of axially poled discs or rings, may be used in high-intensity ultrasonic transducers. Typical applications are echo-sounding (PXE 41), ultrasonic cleaning (PXE 42), and ultrasonic welding and machining (PXE 43).

For echo-sounding, a disc is driven in the 33 thickness mode and is usually housed in a protective plastic encapsulation. The preferred operating frequency lies between 150 and 200 kHz which gives a compact transducer with adequate directivity and reasonable range.

A simple ultrasonic cleaning transducer is formed by a PXE disc, bonded to a metal disc which is itself bonded to the underside of a cleaning tank. The disc is driven in the radial mode at a frequency in the range 40 kHz to 60 kHz and causes the tank wall to vibrate in complex flexure modes, radiating ultrasound in to the tank. For highest ultrasonic intensities, it is advisable to adopt a pre-stressed sandwich construction in which two PXE discs or rings, separated by a thin metal shim, are sandwiched between two metal blocks. The PXE elements are driven in the 33 thickness mode and the complete assembly constitutes a half wave resonator. The whole structure is held together by bolts which subject the ceramic to a compressive force. In this way the ceramic is prevented from going into tension when vibrating. This structure also has the advantages of good heat dissipation, reduced losses owing to the good mechanical properties of metals, and a piezoelectric coupling which need not be much lower than that of a single-piece ceramic transducer. Such sandwich transducers operate in the frequency range 20 kHz to 50 kHz. They may be used for ultrasonic cleaning, in which case they are bonded to the underside of the cleaning tank. For welding or machining, the transducer is bolted to an additional mechanical transformer (horn) which serves to match the output to the acoustic load.

### ACOUSTIC MATCHING OF TRANSDUCERS

When a transducer is coupled to a solid load, matching is usually achieved by means of a horn transformer. For matching to a liquid load, an extra layer with a thickness of one-quarter wavelength may be interposed between transducer and liquid. This interface layer should have an acoustic impedance, intermediate between that of the transducer and the liquid. Many synthetic materials, such as epoxy resins and other plastics, fall within this range.

In sandwich transducers, matching with liquids may also be assisted by forming the radiating metal block from a metal of low acoustic impedance, such as aluminium or magnesium alloy.

### DYNAMIC BEHAVIOUR OF THE TRANSDUCER

High intensity transducers are normally driven at resonance, and the equivalent circuit is as in Fig. 3\*. For maximum efficiency, the transducer should be tuned electrically by means of an inductance given by  $L = 1/(4\pi^2 f^2 C_0)$ . The impedance of the transducer then appears as purely ohmic.

\* See Introduction.

LARGE-SIGNAL PROPERTIES OF PXE 42 AND PXE 43

Behaviour of  $\tan \delta$  and relative permittivity  $\epsilon_{33}^T/\epsilon_0$  under large driving fields.

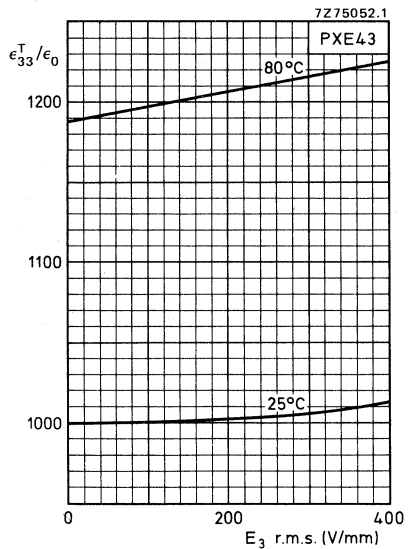
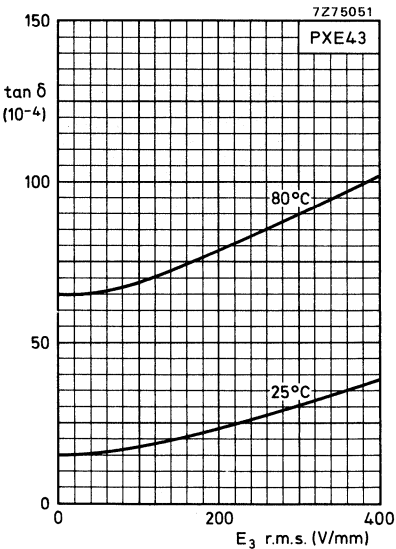
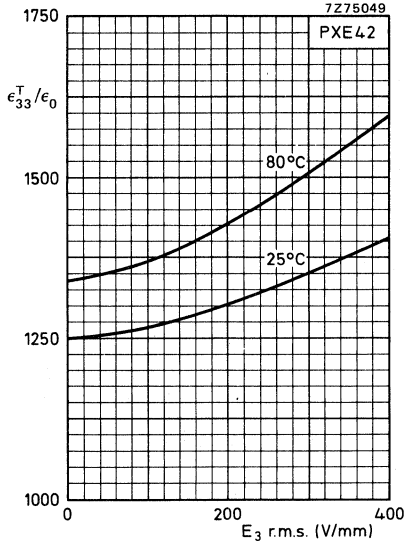
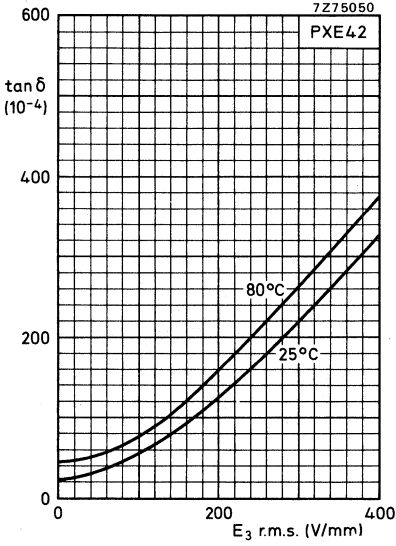

Variation of mechanical quality factor  $Q_m^E$  and elastic compliance  $s_{11}^E$  with dynamic stress in PXE 41, PXE 42, PXE 43.

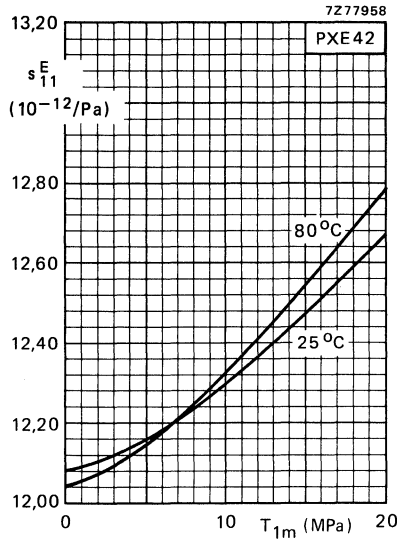
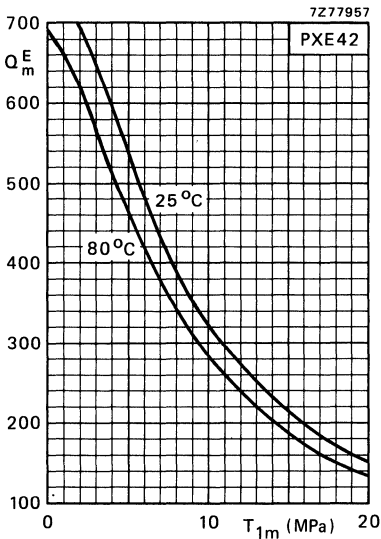
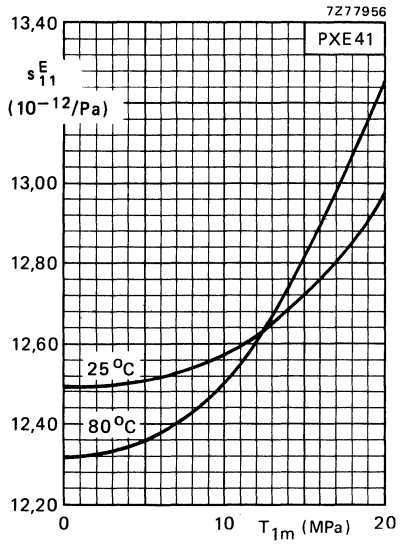
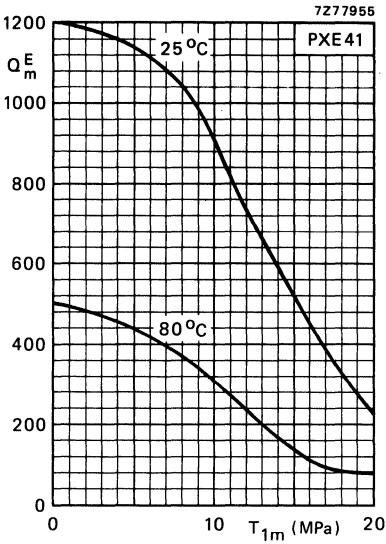

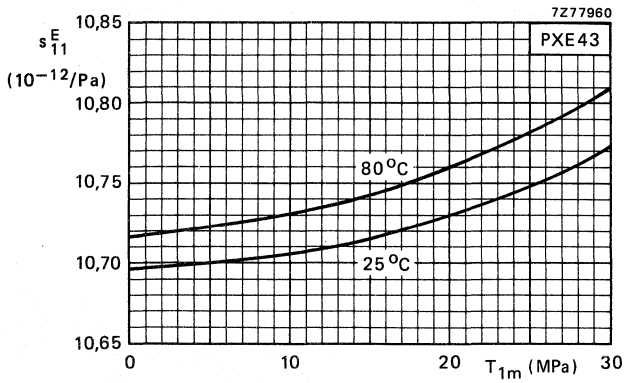
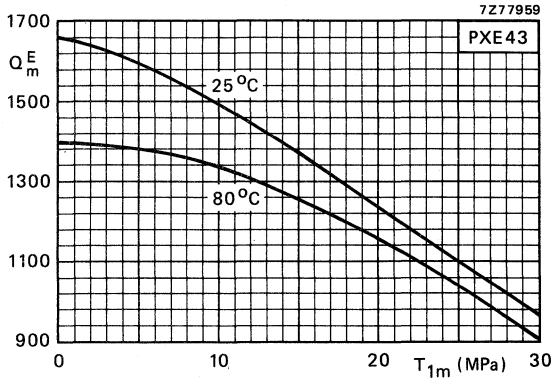

## PIEZOELECTRIC RINGS for ultrasonic applications

The electrodes of the rings are silver plated. The electrode which has been connected to the positive terminal of the polarizing apparatus is identified. The direction of polarization is axial.

### TECHNICAL DATA

Catalogue number	4322 020 06060	4322 020 06130	4322 020 06170
Dimensions in mm	$\phi 10 \times \phi 5 \times 2$	$\phi 20 \times \phi 6 \times 5$	$\phi 20 \times \phi 6 \times 5$
Material	PXE 41	PXE 42	PXE 41
$f_p/f_s$	$\geq 1,05$	$\geq 1,05$	$\geq 1,05$
Nominal capacitance (pF)	320	650	650
Tan $\delta$ max.	4,0	4,0	$4,0 \times 10^{-3}$

### APPLICATIONS

For use in a wide range of applications, e.g.:

- low-power ultrasonic microbonding in semiconductor processes;
- ultrasonic drilling of small holes;
- ultrasonic dental descalers;
- small ultrasonic cleaning devices;
- underwater acoustics.

### MECHANICAL DATA

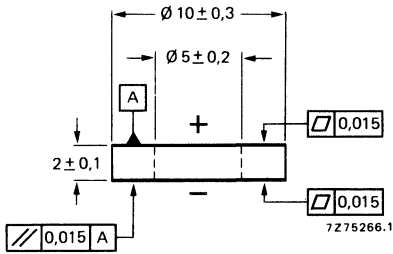

Type 4322 020 06060

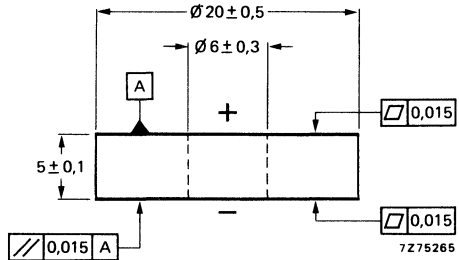

Types 4322 020 06130 and 4322 020 06170



### PIEZOELECTRIC RING for ultrasonic atomisers

The electrodes of the ring are silver plated. The electrode which has been connected to the positive terminal of the polarizing apparatus, is identified. The direction of polarization is axial.

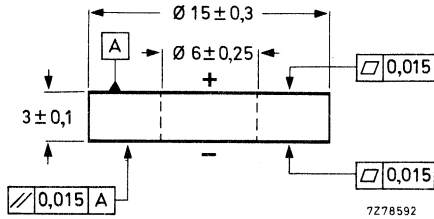

Material	PXE 42
$f_p/f_s$	$\geq 1,06$
Nominal capacitance	550 pF
Tan $\delta$ max.	$4,0 \times 10^{-3}$
→ Catalogue number	4322 020 06470

## PIEZOELECTRIC DISCS for ultrasonic cleaning

The electrodes of the discs are silver plated. The electrode which has been connected to the positive terminal of the polarizing apparatus, is identified. The direction of polarization is axial.

Material: PXE 41  
 Nominal capacitance: 7200 pF  
 Catalogue number: 4322 020 05590

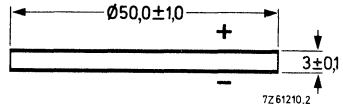

Material: PXE 42  
 Nominal capacitance: 2000 pF  
 Catalogue number: 4322 020 05660

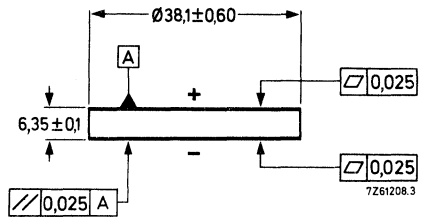

## PIEZOELECTRIC RINGS for ultrasonic cleaning

The electrodes of the rings are silver plated. The electrode which has been connected to the positive terminal of the polarizing apparatus, is identified. The direction of polarization is axial.

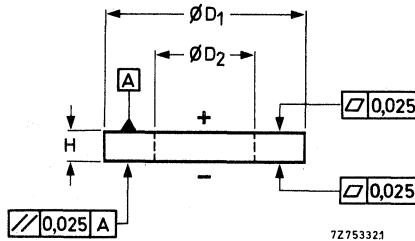

Material: PXE 42

$D_1$ mm	$D_2$ mm	$H$ mm	nom. capacitance pF	catalogue number
$38,1 \pm 0,6$	$12,7 \pm 0,35$	$4 \pm 0,1$	2800	4322 020 06090
$38,1 \pm 0,6$	$12,7 \pm 0,35$	$6,35 \pm 0,1$	1800	4322 020 06040
$\rightarrow 50 \pm 1$	$20 \pm 0,5$	$6 \pm 0,1$	3000	4322 020 06050

### PIEZOELECTRIC RINGS for ultrasonic welding

The electrodes of the rings are silver plated. The electrode which has been connected to the positive terminal of the polarizing apparatus, is identified. The direction of polarization is axial.

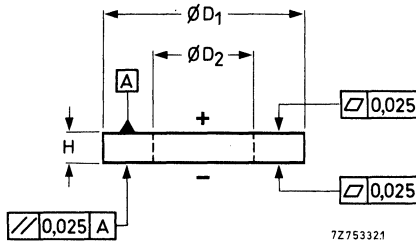

Material: PXE 43

$D_1$ mm	$D_2$ mm	$H$ mm	nom. capacitance pF	catalogue number
$20 \pm 0,5$	$6 \pm 0,3$	$5 \pm 0,1$	500	4322 020 06290
$25 \pm 0,6$	$10 \pm 0,3$	$5 \pm 0,1$	725	4322 020 06280
$38,1 \pm 0,6$	$12,7 \pm 0,35$	$6,35 \pm 0,1$	1400	4322 020 06270
$50 \pm 1$	$20 \pm 0,5$	$5 \pm 0,1$	2900	4322 020 06150
$50 \pm 1$	$20 \pm 0,5$	$6 \pm 0,1$	2400	4322 020 06140

## PIEZOELECTRIC DISCS

for echo sounding probes

The electrodes of the discs are silver plated. The electrode that has been connected to the positive terminal of the polarizing apparatus, is identified. The direction of polarization is axial.

Material: PXE 41  
 Resonant frequency:  $151 \pm 5$  kHz  
 (thickness mode)  
 Thickness: approx. 14,3 mm  
 (adapted to resonant frequency)  
 Nominal capacitance: approx. 620 pF  
 Catalogue number: 4322 020 05240

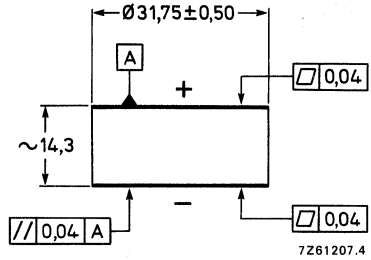

Material: PXE 41  
 Resonant frequency:  $200 \pm 10$  kHz  
 (thickness mode)  
 Thickness: approx. 10,2 mm  
 (adapted to resonant frequency)  
 Nominal capacitance: approx. 520 pF  
 Catalogue number: 4322 020 05750

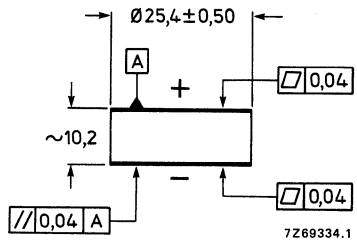

## TRANSDUCER FOR DELAY LINES

These products are used in modern acoustic delay systems with an electro-mechanical transducer which converts electric signals to acoustic signals and back again to electric signals, after having travelled through an acoustic delay medium. Example: colour television receivers.

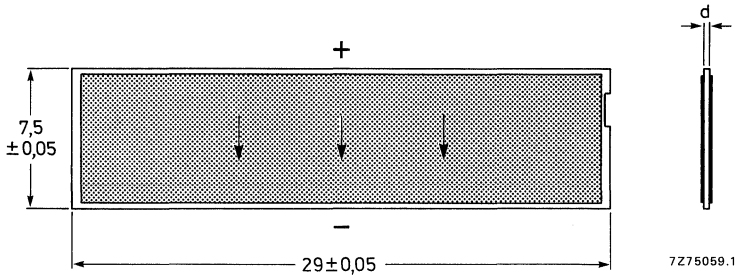

Material: PXE 71  
Resonant frequency:  $4,1 \pm 0,1$  MHz  
Thickness (d): approx. 0,24 mm (adapted to resonant frequency)  
Nominal capacitance: 13 300 pF  
Catalogue number: 3322 027 09001



## INDEX



## INDEX OF CATALOGUE NUMBERS

catalogue number	page	catalogue number	page	catalogue number	page
3322 027 09001	53	4322 020 08870	33	4322 020 17530	28
4322 020 02270	30	08880	33	17540	28
04570	39	08890	33	17550	28
04580	39	08990	34	17560	28
04590	39	13500	29	17570	28
04600	39	13520	29	17580	28
04610	39	13540	29	17590	28
04620	39	13550	29	17600	28
04630	39	13580	29	17610	28
04640	39	13590	29	17620	28
04650	39	13620	29	17630	28
04660	39	13640	29	17640	28
04670	39	13650	29	17650	28
04680	39	13660	29	17660	28
04690	39	14530	41	17670	28
04700	39	14540	41	17680	28
04710	39	14550	41	17690	28
05240	52	14560	41	17700	28
05590	49	14570	41	17710	28
05660	49	14580	41	17720	28
05750	52	14590	41	17730	31
06040	50	14600	41	17740	31
06050	50	14610	41	17750	31
06060	47	14620	41	17760	31
06090	50	16320	32	17770	31
06130	47	16330	32	17780	31
06140	51	16340	32	17790	31
06150	51	16350	32	19050	42
06170	47	16360	32	19060	42
06270	51	16370	32	19070	42
06280	51	16380	32		
06290	51	16390	32		
06470	48	16400	32		
07590	40	16410	32		
08230	39	16470	34		
08240	39	16480	34		
08250	39	16490	34		
08820	33	17500	28		
08840	33	17510	28		
08850	33	17520	28		

# Electronic components and materials for professional, industrial and consumer uses from the world-wide Philips Group of Companies

**Argentina:** PHILIPS ARGENTINA S.A., Div. Elcoma, Vedia 3892, 1430 BUENOS AIRES, Tel. 541-7141/7242/7343/7444/7545.  
**Australia:** PHILIPS INDUSTRIES HOLDINGS LTD., Elcoma Division, 11 Waltham Street, ARTARMON, N.S.W. 2064, Tel. (02) 439 3322.  
**Austria:** ÖSTERREICHISCHE PHILIPS BAUELEMENTE INDUSTRIE G.m.b.H., Triester Str. 64, A-1101 WIEN, Tel. 62 91 11.  
**Belgium:** N.V. PHILIPS & MBLE ASSOCIATED, 9 rue du Pavillon, B-1030 BRUXELLES, Tel. (02) 242 74 00.  
**Brazil:** IBRAPE, Caixa Postal 7383, Av. Brigadeiro Faria Lima, 1735 SAO PAULO, SP, Tel. (011) 211-2600.  
**Canada:** PHILIPS ELECTRONICS LTD., Elcoma Division, 601 Milner Ave., SCARBOROUGH, Ontario, M1B 1M8, Tel. 292-5161.  
**Chile:** PHILIPS CHILENA S.A., Av. Santa Maria 0760, SANTIAGO, Tel. 39-4001.  
**Colombia:** IND. PHILIPS DE COLOMBIA S.A., c/o IPRELENZO LTD., Cra. 21, No. 56-17, BOGOTA, D.E., Tel. 2 49 76 24.  
**Denmark:** MINIWATT A/S, Strandlodsvej 2, P.O. Box 1919, DK 2300 COPENHAGEN S, Tel. (01) 54 11 33.  
**Finland:** OY PHILIPS AB, Elcoma Division, Kaivokatu 8, SF-00100 HELSINKI 10, Tel. 1 72 71.  
**France:** R.T.C. LA RADIOTECHNIQUE-COMPELEC, 130 Avenue Ledru Rollin, F-75540 PARIS 11, Tel. 338 80-00.  
**Germany (Fed. Republic):** VALVO, UB Bauelemente der Philips G.m.b.H., Valvo Haus, Burchardstrasse 19, D-2 HAMBURG 1, Tel. (040) 3296-0.  
**Greece:** PHILIPS S.A. HELLENIQUE, Elcoma Division, 52, Av. Syngrou, ATHENS, Tel. 9251511.  
**Hong Kong:** PHILIPS HONG KONG LTD., Elcoma Div., 15/F Philips Ind. Bldg., 24-28 Kung Yip St., KWAI CHUNG, Tel. (0)-24 51 21.  
**India:** PEICO ELECTRONICS & ELECTRICALS LTD., Elcoma Dept., Band Box Building, 254-D Dr. Annie Besant Rd., BOMBAY - 400 025, Tel. 4220387/4220311.  
**Indonesia:** P.T. PHILIPS-RALIN ELECTRONICS, Elcoma Div., Panim Bank Building, 2nd Fl., Jl. Jend. Sudirman, P.O. Box 223, JAKARTA, Tel. 716131.  
**Ireland:** PHILIPS ELECTRICAL (IRELAND) LTD., Newstead, Clonskeagh, DUBLIN 14, Tel. 69 33 55.  
**Italy:** PHILIPS S.p.A., Sezione Elcoma, Piazza IV Novembre 3, I-20124 MILANO, Tel. 2-67521.  
**Japan:** NIHON PHILIPS CORP., Shuwa Shinagawa Bldg., 26-33 Takanawa 3-chome, Minato-ku, TOKYO (108), Tel. 448-5611.  
(IC Products) SIGNETICS JAPAN LTD., 8-7 Sanbancho Chiyoda-ku, TOKYO 102, Tel. (03) 230-1521.  
**Korea (Republic of):** PHILIPS ELECTRONICS (KOREA) LTD., Elcoma Div., Philips House, 260-199 Itaewon-dong, Yongsan-ku, SEOUL, Tel. 794-4202.  
**Malaysia:** PHILIPS MALAYSIA SDN. BERHAD, No. 4 Persiaran Barat, Petaling Jaya, P.O.B. 2163, KUALA LUMPUR, Selangor, Tel. 77 44 11.  
**Mexico:** ELECTRONICA, S.A. de C.V., Carr. México-Toluca km. 62.5, TOLUCA, Edo. de México 50140, Tel. Toluca 91 (721) 613-00.  
**Netherlands:** PHILIPS NEDERLAND, Marktgroep Elonco, Postbus 90050, 5600 PB EINDHOVEN, Tel. (040) 793333.  
**New Zealand:** PHILIPS NEW ZEALAND LTD., Elcoma Division, 110 Mt. Eden Road, C.P.O. Box 1041, AUCKLAND, Tel. 605-914.  
**Norway:** NORSK A/S PHILIPS, Electronica Dept., Sandstuveien 70, OSLO 6, Tel. 680200.  
**Peru:** CADESA, Av. Alfonso Ugarte 1268, LIMA 5, Tel. 326070.  
**Philippines:** PHILIPS INDUSTRIAL DEV. INC., 2246 Pasong Tamo, P.O. Box 911, Makati Comm. Centre, MAKATI-RIZAL 3116, Tel. 86-89-51 to 59.  
**Portugal:** PHILIPS PORTUGUESA S.A. R.L., Av. Eng. Duarte Pacheco 6, 1009 LISBOA Codex, Tel. 68 31 21.  
**Singapore:** PHILIPS PROJECT DEV. (Singapore) PTE LTD., Elcoma Div., Lorong 1, Toa Payoh, SINGAPORE 1231, Tel. 35 02 000.  
**South Africa:** EDAC (PTY) LTD., 3rd Floor Rainer House, Upper Railway Rd. & Ove St., New Doornfontein, JOHANNESBURG 2001, Tel. 614-2362/9.  
**Spain:** MINIWATT S.A., Balmes 22, BARCELONA 7, Tel. 301 63 12.  
**Sweden:** PHILIPS KOMPLEMENTER A.B., Lidingsvägen 50, S-11584 STOCKHOLM 27, Tel. 08/7821000.  
**Switzerland:** PHILIPS A.G., Elcoma Dept., Allmendstrasse 140-142, CH-8027 ZÜRICH, Tel. 01-488 22 11.  
**Taiwan:** PHILIPS TAIWAN LTD., 3rd Fl., San Min Building, 57-1, Chung Shan N. Rd, Section 2, P.O. Box 22978, TAIPEI, Tel. (02)-5631717.  
**Thailand:** PHILIPS ELECTRICAL CO. OF THAILAND LTD., 283 Silom Road, P.O. Box 961, BANGKOK, Tel. 233-6330-9.  
**Turkey:** TÜRK PHILIPS TICARET A.S., Elcoma Department, İnönü Cad. No. 78-80, ISTANBUL, Tel. 43 59 10.  
**United Kingdom:** MULLARD LTD., Mullard House, Torrington Place, LONDON WC1E 7HD, Tel. 01-5806633.  
**United States:** (Active Devices & Materials) AMPEREX SALES CORP., Providence Pike, SLATERSVILLE, R.I. 02876, Tel. (401) 762-9000.  
(Passive Devices) MEPCO/ELECTRA INC., Columbia Rd., MORRISTOWN, N.J. 07960, Tel. (201) 539-2000.  
(Passive Devices & Electromechanical Devices) CENTRALAB INC., 5855 N. Glen Park Rd., MILWAUKEE, WI 53201, Tel. (414) 228-7380.  
(IC Products) SIGNETICS CORPORATION, 811 East Arques Avenue, SUNNYVALE, California 94086, Tel. (408) 739-7700.  
**Uruguay:** LUZILECTRON S.A., Avda Uruguay 1287, P.O. Box 907, MONTEVIDEO, Tel. 91 43 21.  
**Venezuela:** IND. VENEZOLANAS PHILIPS S.A., c/o MAGNETICA S.A., Calle 6, Ed. Las Tres Jotas, App. Post. 78117, CARACAS, Tel. (02) 2393931

**For all other countries apply to:** Philips Electronic Components and Materials Division, International Business Relations, Building BA6, P.O. Box 218, 5600 MD EINDHOVEN, The Netherlands, Tel. +31 4072 3304, Telex 35000 phtncf

This information is furnished for guidance, and with no guarantee as to its accuracy or completeness; its publication conveys no licence under any patent or other right, nor does the publisher assume liability for any consequence of its use; specifications and availability of goods mentioned in it are subject to change without notice; it is not to be reproduced in any way, in whole or in part, without the written consent of the publisher.