

TYPES 2N389 and 2N424 N-P-N DIFFUSED JUNCTION SILICON POWER TRANSISTORS

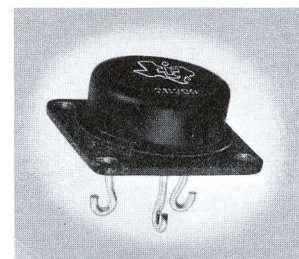

85 watts at 25°C with infinite heat sink

**Minimum beta of 8 at -55°C
-65°C to +200°C operating and storage range
Temperature stabilized at 215°C**



qualification testing

Each unit is heat cycled from -65°C to +175°C for ten cycles, and then the hermetic seal is tested by subjecting immersed units to hydraulic pressure. Each unit is thoroughly tested to determine the electrical design characteristics. Production samples are life tested periodically to determine the effects of storage and dissipation and ensure maximum attainable reliability.

mechanical data

To assure maximum reliability, stability and long life, the case is hermetically sealed by a proven projection welding technique and is designed to meet the stringent requirements of MIL-T-19500. Four mounting holes in the base provide means for mounting the unit, with good thermal contact, to an external heat sink. Each unit has a metal case with glass-to-metal seal between case and leads. Approximate weight is 12 grams.

THE COLLECTOR IS IN ELECTRICAL CONTACT WITH THE CASE

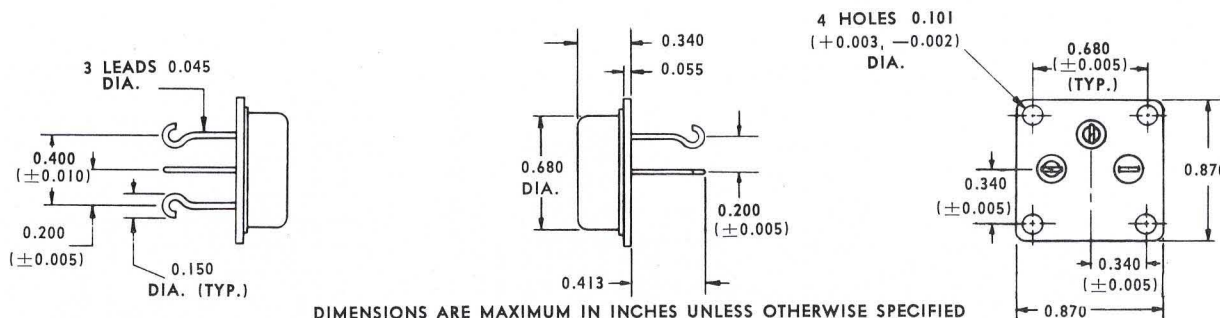

maximum ratings

Collector voltage referred to emitter at 25°C (Breakdown voltages are indicated below)
Total dissipation at 25°C (case temperature)* 85 W
Total dissipation at 100°C (case temperature)* 45 W
Junction temperature (maximum range) -65°C to +200°C

* Derate 0.485 W/°C increase in case temperature within range of 25°C to 200°C

maximum and minimum design characteristics at T_c = 25°C (except as indicated)

| PARAMETER | TEST CONDITIONS | 2N389 | | 2N424 | | unit |
|---|---|-------|------|-------|------|------|
| | | min. | max. | min. | max. | |
| BV _{CER} Breakdown Voltage | I _C = 10mA, R _{BE} = 33 | 60 | — | 80 | — | Volt |
| BV _{EBO} Breakdown Voltage | I _E = 10mA, I _C = 0 | 10 | — | 10 | — | Volt |
| I _{CER} Collector Cutoff Current | T _C = 100°C, V _{CE} = 60V, R _{BE} = 33 | — | 10 | — | 10 | mA |
| I _C Collector Current † | V _{BE} = 8V, V _{CE} = 15V | 1.5 | — | 0.75 | — | Amp |
| R _{CS} Saturation Resistance † | I _C = 1A, I _B = 0.2A | — | 5 | — | 10 | Ohm |
| h _{FE} Current Transfer Ratio † | I _C = 1A, V _{CE} = 15V | 12 | 60 | 12 | 60 | — |
| h _{FE} @ -55°C † | I _C = 1A, V _{CE} = 15V | 8 | — | 8 | — | — |

† Semiautomatic testing is facilitated by using pulse techniques to measure these parameters. A 300-microsecond pulse (approximately 2% duty cycle) is utilized. Thus, the unit can be tested under maximum current conditions without a significant increase in junction temperature, even though no heat sink is used. The parameter values obtained in this manner are particularly pertinent for switching circuit design and, in general, indicate the true capabilities of the device.

LICENSED UNDER BELL SYSTEM PATENTS

SEMICONDUCTOR-COMPONENTS DIVISION

TEXAS INSTRUMENTS
INCORPORATED
POST OFFICE BOX 312 • DALLAS, TEXAS

TYPES 2N389, 2N424
BULLETIN No. DL-S 962, AUGUST, 1958
REPLACES BULLETINS No. DL-S 769, AUGUST, 1957 and DL-S 790, JULY, 1957

TYPICAL CHARACTERISTICS (AS INDICATED)

TYPE 2N389

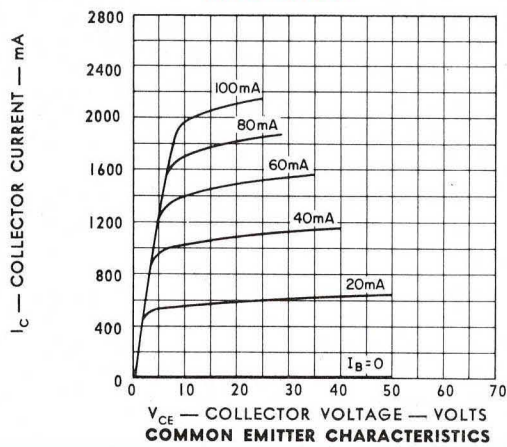

TYPE 2N424

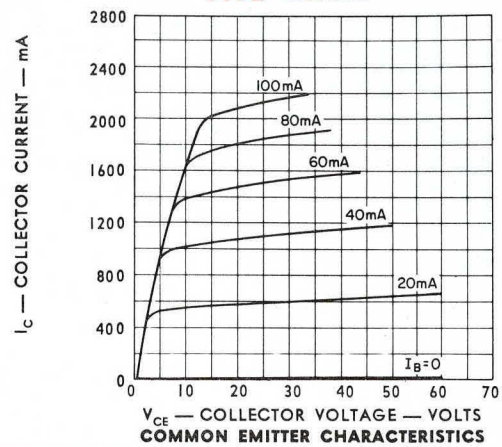

TYPE 2N389

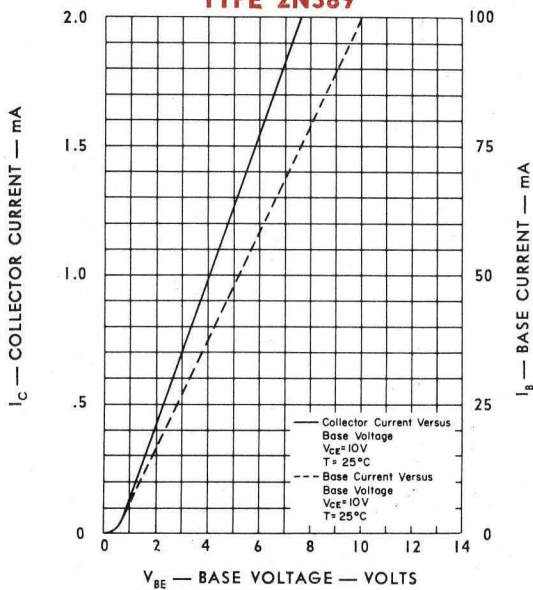

TYPE 2N424

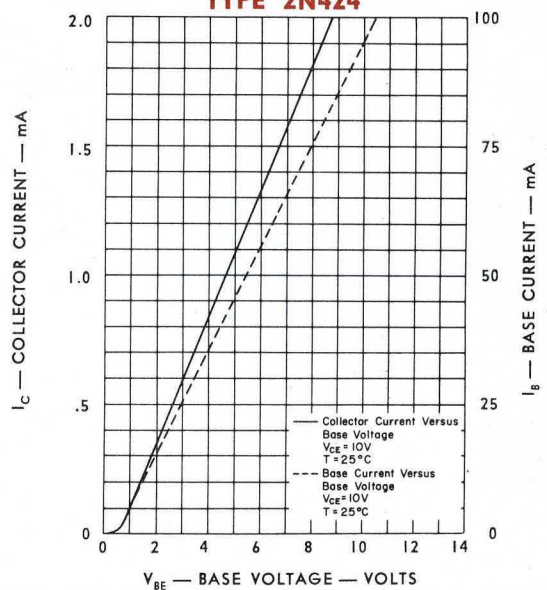

typical design characteristics at $T_c = 25^\circ\text{C}$

| PARAMETER | TEST CONDITIONS | 2N389 | 2N424 | unit |
|--|--|-------|-------|-----------------|
| H_{i_e} Input Impedance | $V_{CE} = 30V$ $I_C = 0.3A$ $I_C = 0.1a$ | 75 | 75 | ohm |
| H_{r_e} Forward Current Gain | $V_{CE} = 30V$ $I_C = 0.3A$ $I_C = 0.1a$ | 30 | 30 | — |
| H_{o_e} Output Admittance | $V_{CE} = 30V$ $I_C = 0.3A$ $V_{ce} = 10V$ | 1000 | 1000 | μmho |
| H_{r_e} Reverse Voltage Gain | $V_{CE} = 30V$ $I_C = 0.3A$ $V_{ce} = 10V$ | 0.003 | 0.003 | — |
| h_{r_e} Forward Current Gain @ 1 megacycle | $V_{CE} = 30V$ $I_C = 0.3A$ $f = 1\text{mc}$ | 8.5 | 6.0 | — |

EXPLANATION OF CURVES:

1. The curves shown are based on extensive data. Individual units or small groups of units may not conform.
2. All temperatures are ambient except where noted.

TYPICAL PRODUCTION DISTRIBUTIONS (AS INDICATED)

TYPE 2N389

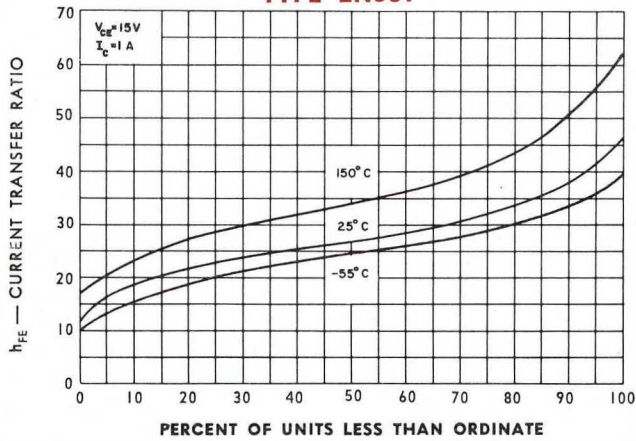

TYPE 2N424

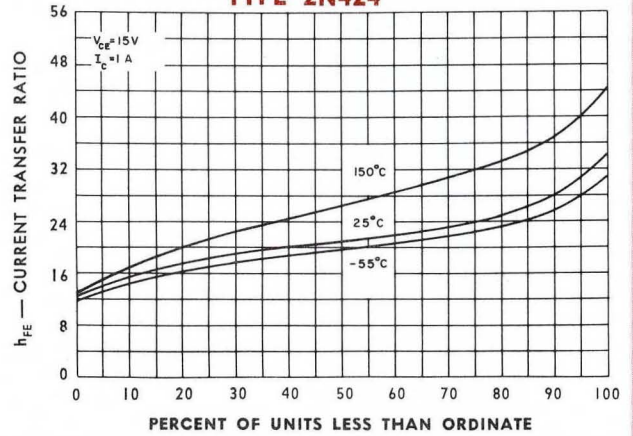

TYPE 2N389

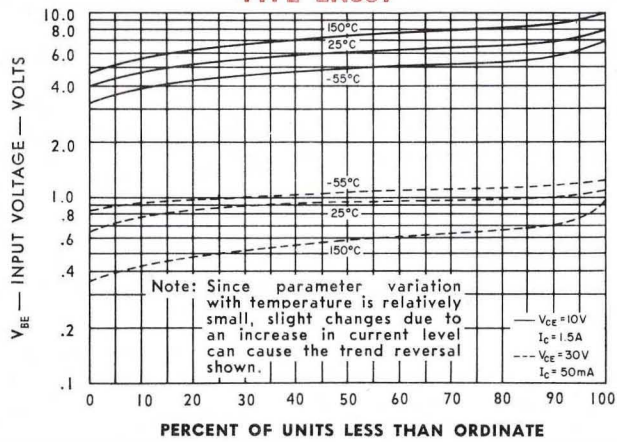

TYPE 2N424

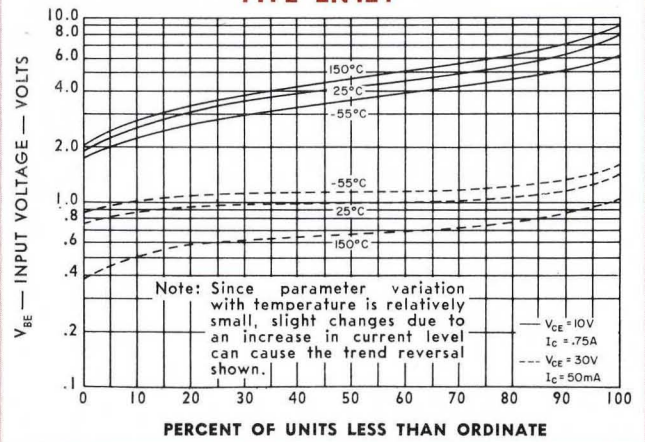

TYPE 2N389

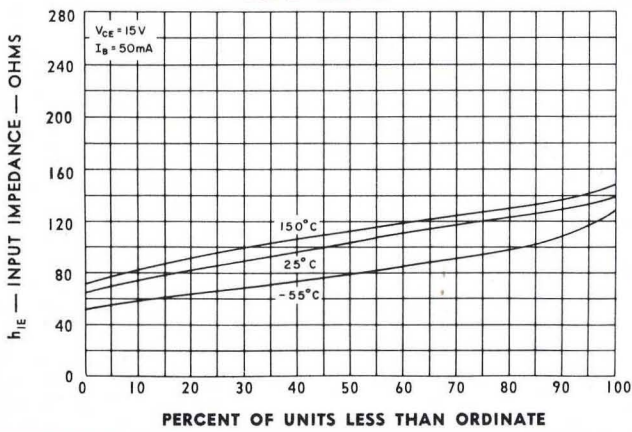

TYPE 2N424

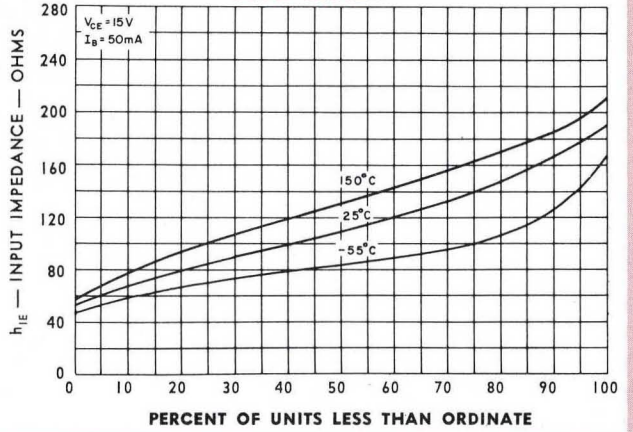

exactly to the curves. Hence, these curves should be considered to be typical.



TYPICAL PRODUCTION DISTRIBUTIONS

(AS INDICATED)

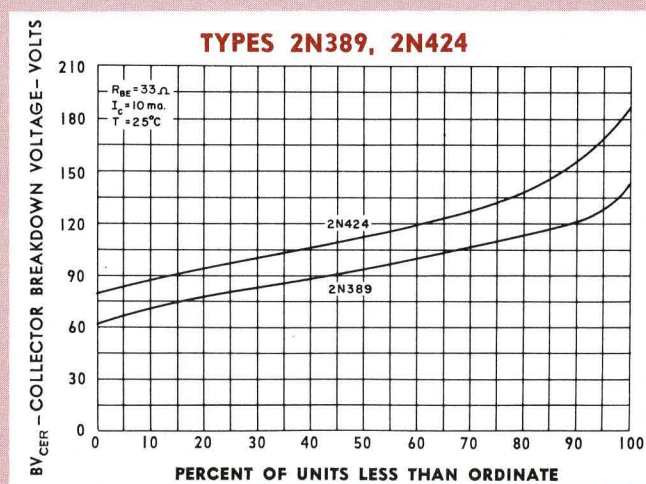
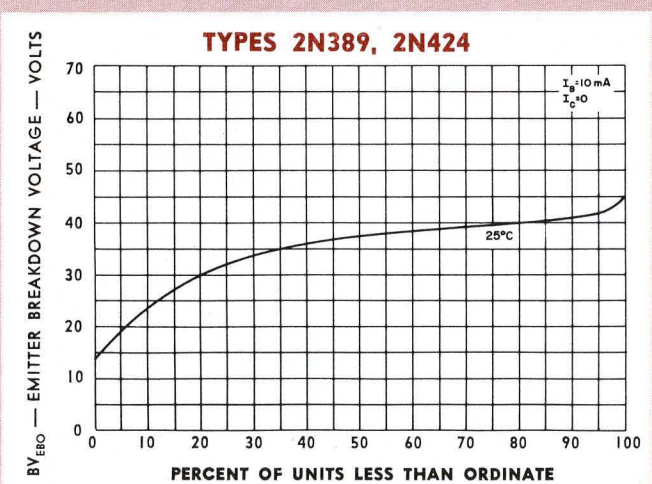
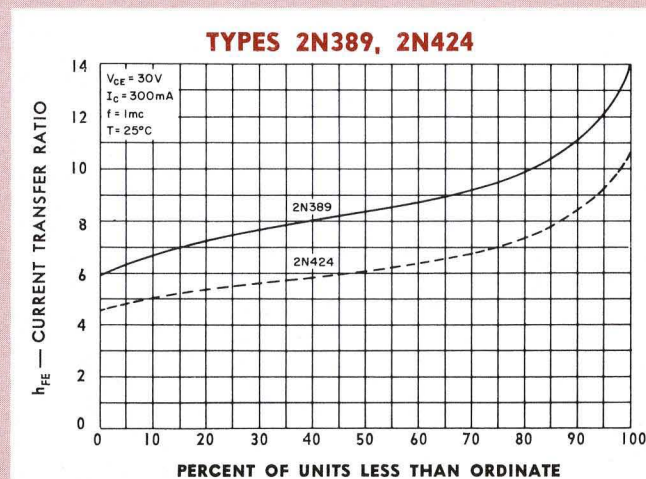
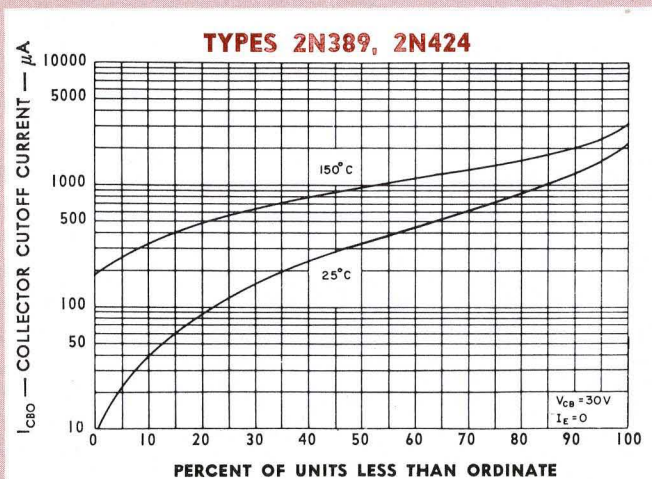
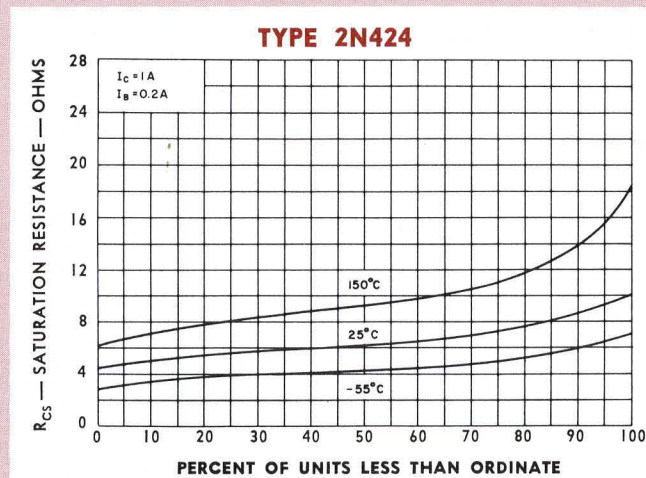
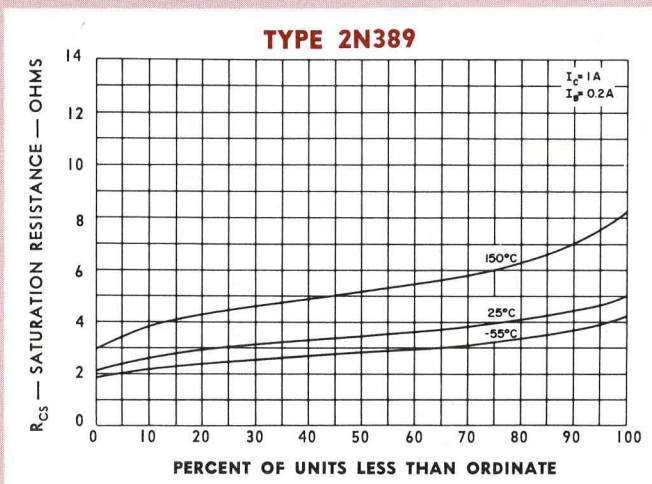

TYPICAL PRODUCTION DISTRIBUTIONS

(AS INDICATED)

TYPE 2N389

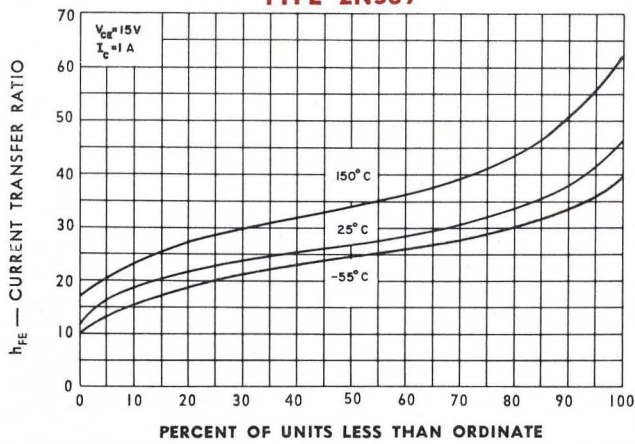

TYPE 2N424

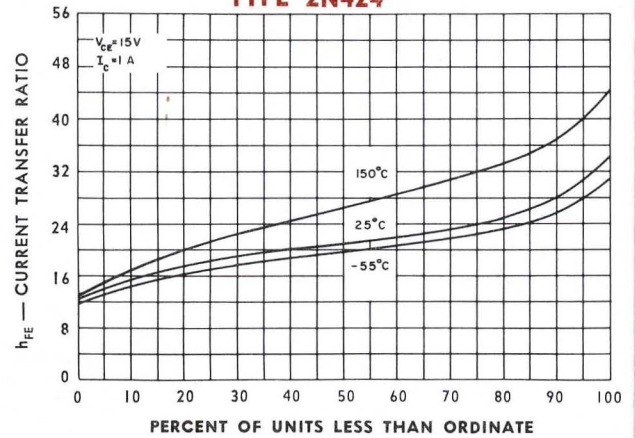

TYPE 2N389

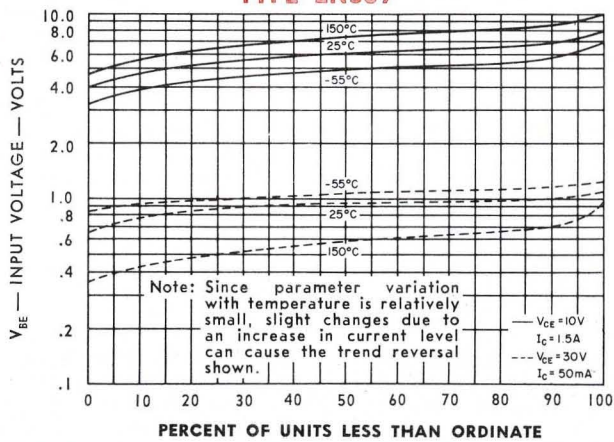

TYPE 2N424

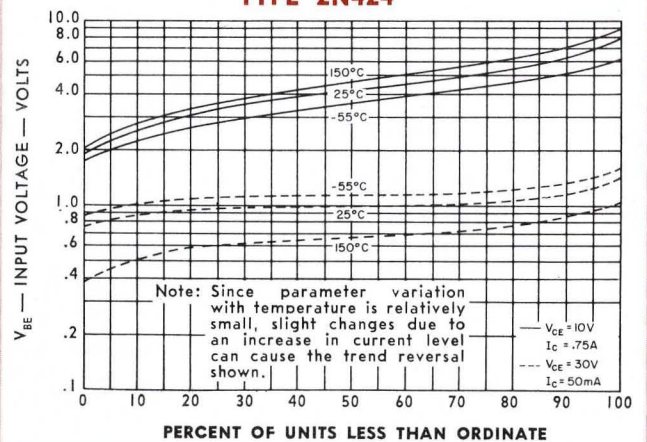

TYPE 2N389

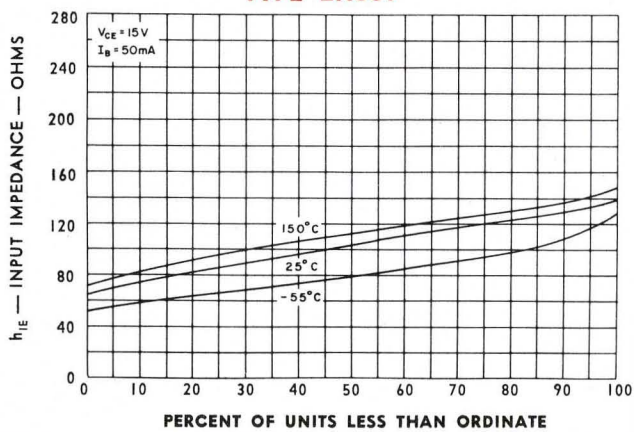

TYPE 2N424

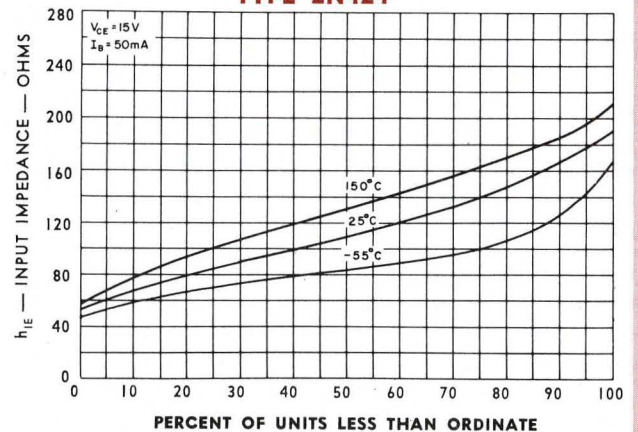

conform exactly to the curves. Hence, these curves should be considered to be typical.



SEMICONDUCTOR-COMPONENTS DIVISION

TYPICAL PRODUCTION DISTRIBUTIONS

(AS INDICATED)

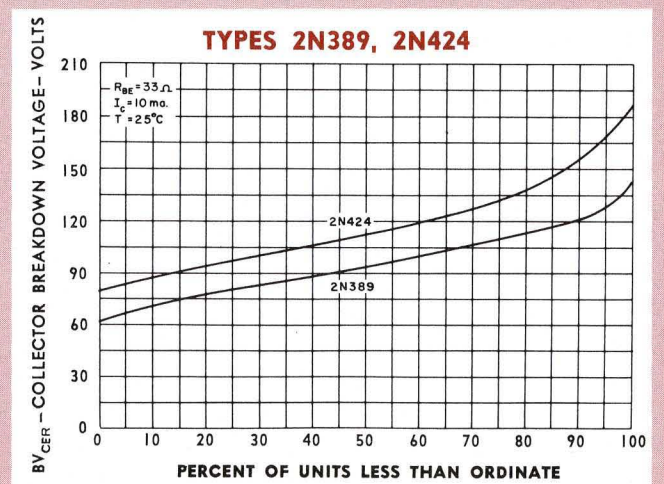
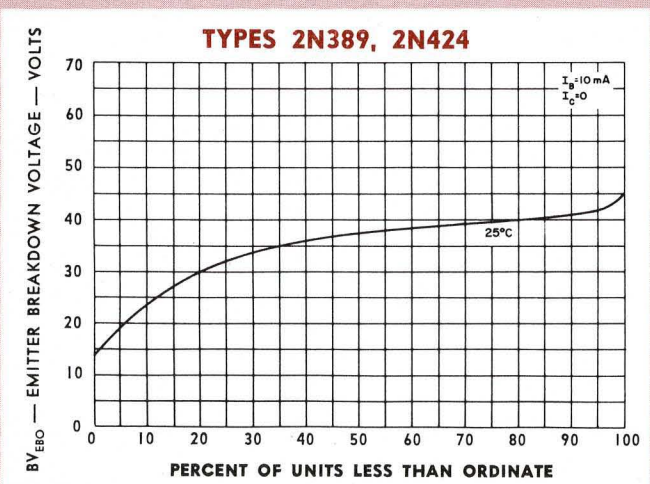
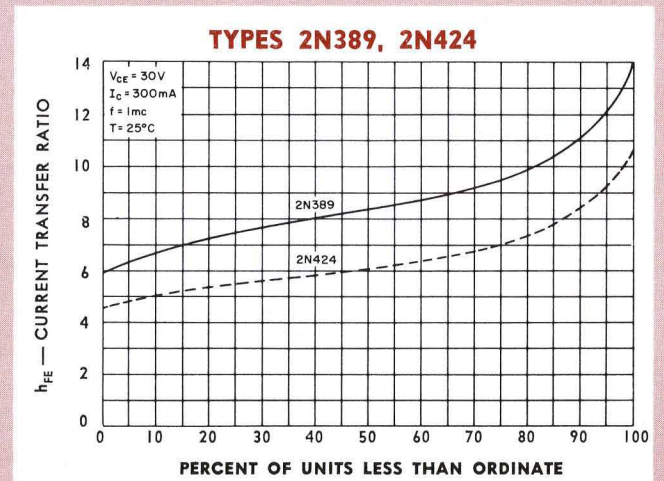
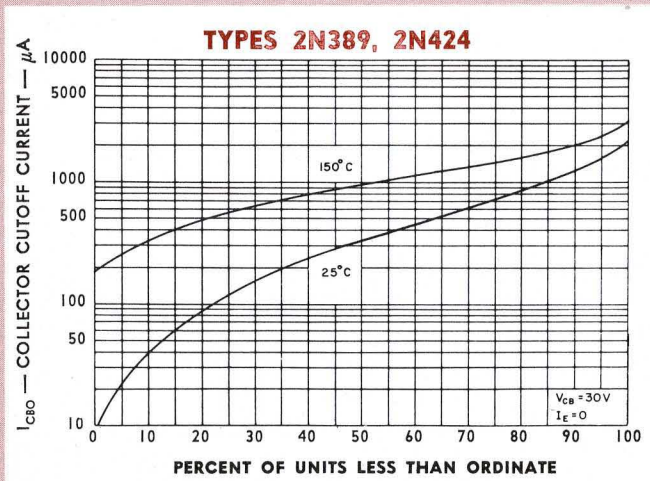
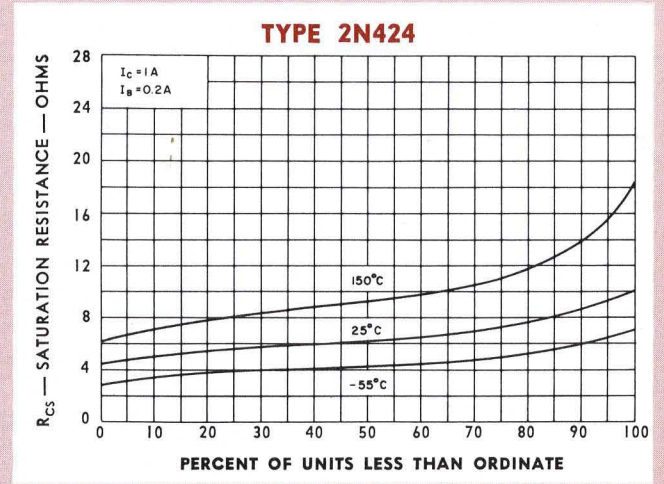
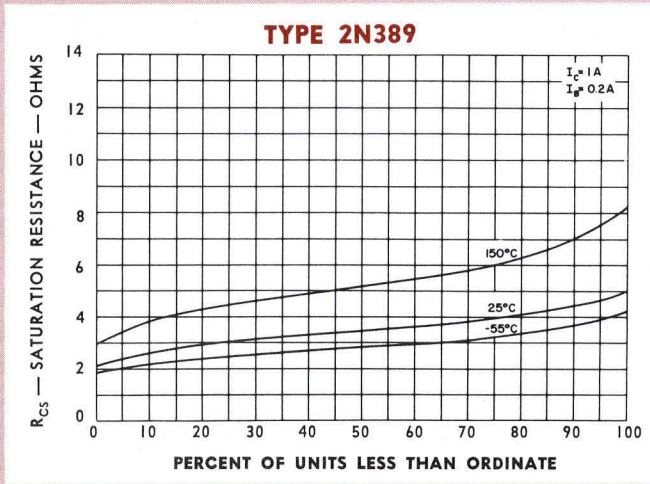

APPLICATION NOTES

TYPES 2N389, 2N424

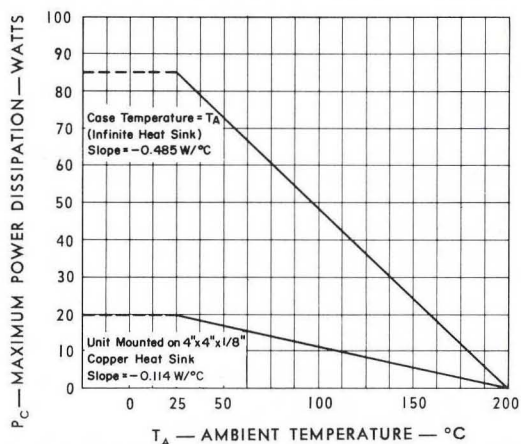
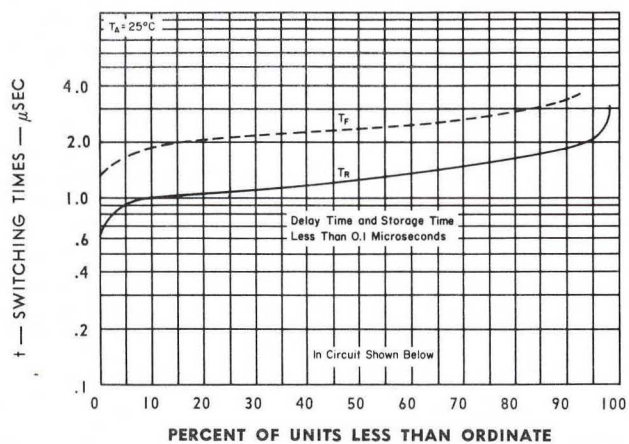

TYPICAL SATURATING TYPE SWITCHING CIRCUIT

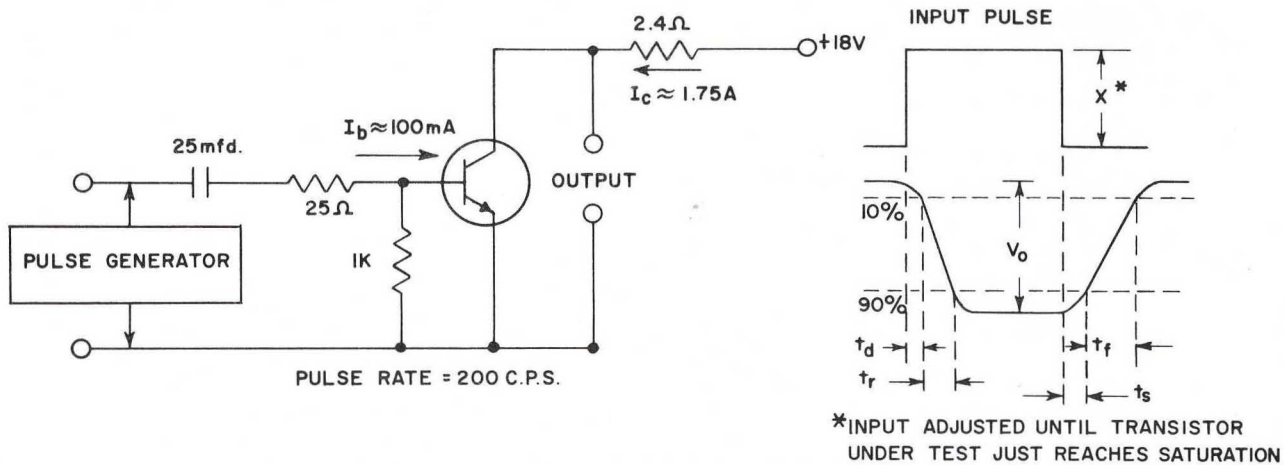

N-P-N DIFFUSED JUNCTION SILICON POWER TRANSISTORS

TYPES 2N389, 2N424

REGION OFFICES

SOUTHERN REGION
DALLAS, Texas
P. O. Box 312
ADams 5-3111

EASTERN REGION
99 Park Avenue
NEW YORK 16, New York
MUrray Hill 2-7951

MID-AMERICA REGION
4104 N. Harlem Avenue
CHICAGO 34, Illinois
NAtional 5-8330

WESTERN REGION
1741 Ivar Avenue
LOS ANGELES 28, California
HOLlywood 2-6977

SALES OFFICES
701 Wilson Building
CAMDEN 2, New Jersey
WOOdlawn 4-4978

401 Monument Building
11 West Monument Street
DAYTON 2, Ohio
BALdwin 8-5801

655 Broadway
DENVER 3, Colorado
AMherst 6-3675

20131 James Couzens Highway
DETROIT, Michigan
BRoadway 2-1713

53 Queen Street
OTTAWA 4, Ontario, Canada
CEntral 6-3430

317 Town and Country Village
PALO ALTO, California
DAvenport 6-6770

326 Broadway
SAN DIEGO 12, California
BEImont 2-2006

State Tower Building
SYRACUSE 2, New York
GRanite 1-4041

751 Main St.
WALTHAM 54, Massachusetts
TWInbrook 3-2052

1413 K Street, NW
WASHINGTON, D. C.
STERling 3-5865

For immediate delivery of TI semi-conductors in 1-99 quantities at factory prices, call on your nearest TI distributor.

DISTRIBUTORS

ALBUQUERQUE, New Mexico
MIDLAND SPECIALTY COMPANY
1712 Lomas Blvd., N.E.
Tel: 7-0236

ATLANTA 13, Georgia
ACK RADIO SUPPLY CO. OF GEORGIA
331 Luckie Street, N.W.
JA 4-8477

BIRMINGHAM 5, Alabama
ACK RADIO SUPPLY COMPANY
3101 Fourth Avenue South
FA 2-0588

BOSTON 10, Massachusetts
RADIO WIRE TELEVISION, INC.
110 Federal Street
HU 2-7850

BUFFALO 16, New York
GENESEE RADIO & PARTS CO., INC.
2550 Delaware Avenue
DE 9661

CAMDEN 2, New Jersey
GENERAL RADIO SUPPLY COMPANY
600 Penn Street
WO 4-8560

CEDAR RAPIDS, Iowa
GIFFORD-BROWN, INC.
INDUSTRIAL ELECTRONICS DIVISION
618 First Street N.W.
EM 4-2493

CHICAGO 80, Illinois
ALLIED RADIO CORPORATION
100 N. Western Avenue
HA 1-6800

CHICAGO 6, Illinois
NEWARK ELECTRIC CO., INC.
223 W. Madison Street
ST 2-2944

CINCINNATI 10, Ohio
HERRLINGER DISTRIBUTING CO.
Fifteenth and Vine Sts.
CH 1-7273

CLEVELAND 15, Ohio
PIONEER ELECTRONIC SUPPLY CO.
2115 Prospect Avenue
SU 1-9410

DALLAS 35, Texas
ENGINEERING SUPPLY COMPANY
6000 Denton Drive
FL 7-2861

DAYTON 4, Ohio
SREPCO, INCORPORATED
314 Leo Street
BA 4-3871

DENVER 4, Colorado
DENVER ELECTRONIC SUPPLY COMPANY
1254 Arapahoe Street
AM 6-1671

DETROIT 38, Michigan
FERGUSON ELECTRONIC SUPPLY CO.
2306 Puritan Avenue
UN 1-6700

EL PASO, Texas
MIDLAND SPECIALTY COMPANY
500 W. Paisano Drive
KE 3-9555

GLENDALE 1, California
R. V. WEATHERFORD COMPANY
6921 San Fernando Road
VI 9-2471

HOUSTON 2, Texas
HARRISON EQUIPMENT COMPANY, INC.
1422 San Jacinto (Box 2514)
CA 4-9131

JAMAICA 33, New York
RADIO WIRE TELEVISION, INC.
165-08 Liberty Avenue
JA 3-4600

LOS ANGELES 15, California
RADIO PRODUCTS SALES, INC.
1501 S. Hill Street
RI 9-7471

WEST LOS ANGELES 64, Calif.
CALIFORNIA ELECTRONICS SUPPLY, INC.
11801-11 W. Pico Blvd.
BR 2-2124

MELBOURNE, Florida
ELECTRONIC SUPPLY
909 Morningside Drive
Tel: 1735

MIAMI 32, Florida
ELECTRONIC SUPPLY
61 N.E. Ninth Street
FR 9-4512

MINNEAPOLIS, Minnesota
STARKE RADIO SUPPLY COMPANY
71 South 12th Street
FE 2-1325

NEWARK 2, New Jersey
RADIO WIRE TELEVISION OF N.J. INC.
24 Central Avenue
MA 2-1661

NEW YORK 6, New York
MILGRAY ELECTRONICS, INCORPORATED
136 Liberty Street
RE 2-4400

NEW YORK 13, New York
RADIO WIRE TELEVISION, INC.
100 Sixth Avenue
RE 2-8600

OAKLAND 7, California
ELMAR ELECTRONICS, INC.
140 Eleventh Street
HI 4-7011

PHOENIX, Arizona
RADIO SPECIALTIES & APPLIANCE CORP.
917 North 7th Street
AL 8-6121

PLAINFIELD, New Jersey
LAFAYETTE RADIO CORPORATION
139 W. Second Street
PL 6-4718

ROCHESTER 5, New York
ROCHESTER RADIO SUPPLY CO., INC.
600 E. Main Street
LO 2-9900

SALT LAKE CITY 10, Utah
STANDARD SUPPLY COMPANY
225 East Sixth South Street
EL 5-2971

SAN DIEGO 1, California
RADIO PARTS COMPANY, INC.
2060 India Street
BE 9-9361

TULSA 10, Oklahoma
ENGINEERING SUPPLY COMPANY
1124 East 4th Street
DI 3-8121

WASHINGTON 1, D. C.
ELECTRONIC INDUSTRIAL SALES, INC.
2345 Sherman Ave., N.W.
HU 3-5200

TEXAS INSTRUMENTS
INCORPORATED
POST OFFICE BOX 312 • DALLAS • TEXAS

TO SUPPLY THE BEST PRODUCTS POSSIBLE, TEXAS INSTRUMENTS
RESERVES THE RIGHT TO MAKE CHANGES AT ANY TIME.

PRINTED IN U.S.A.