

~~SAN JOSE~~
~~PUBLIC LIBRARY~~

December, 1968

computers and automation

City of the Future?

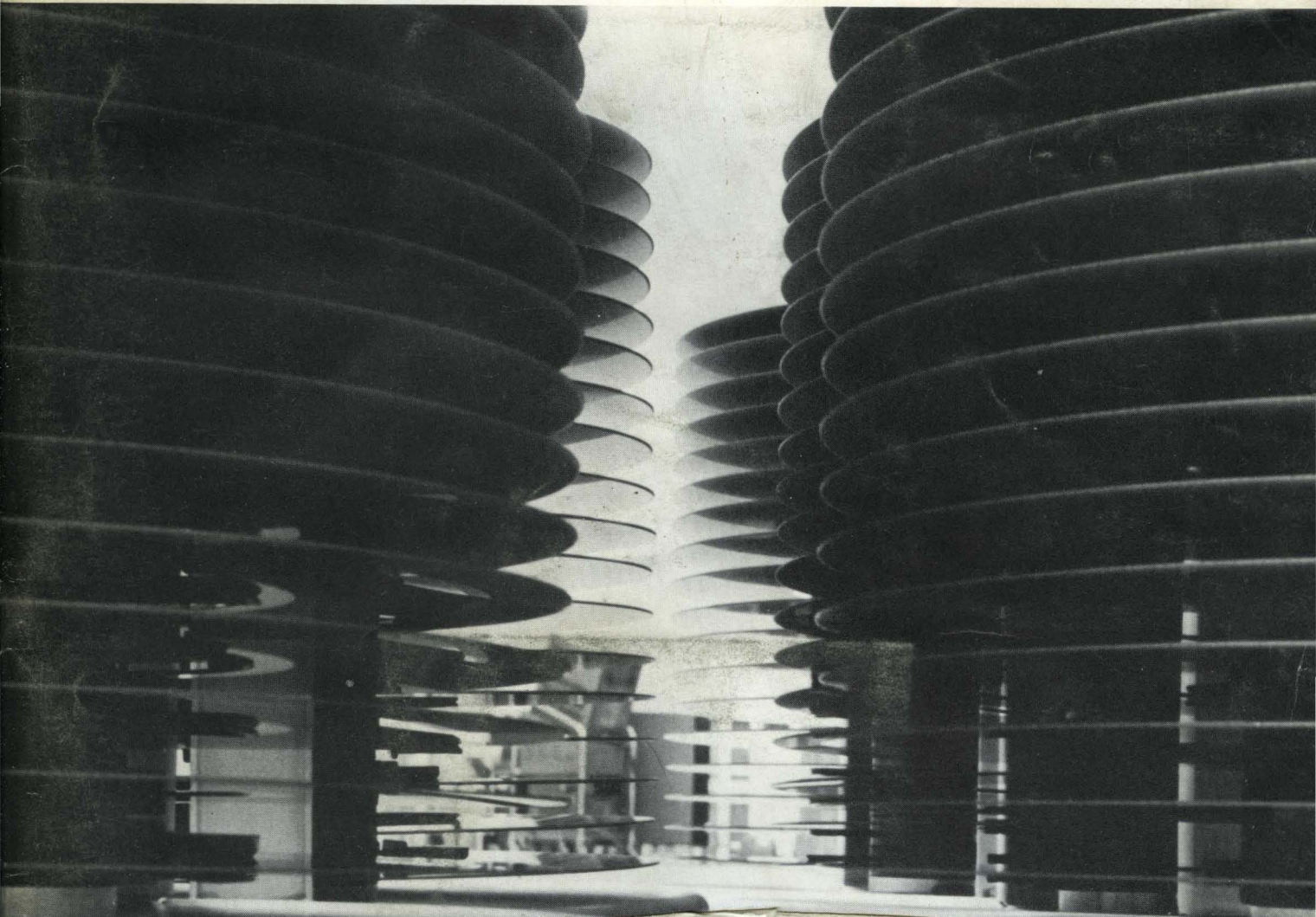

ERIODICALS SEC
110 S MARKET ST / *N1269
SAN JOSE CA 95113

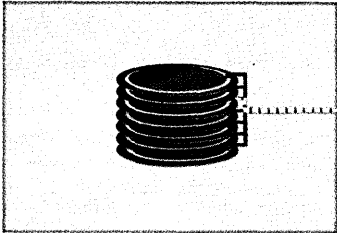
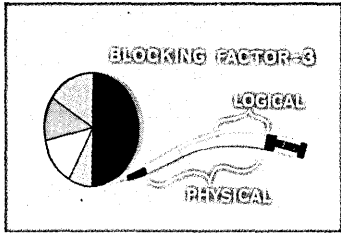
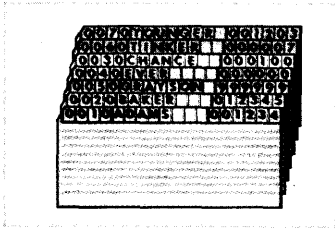

ACE

◇ T.M. Edutronics, Inc.

..Super Teacher!

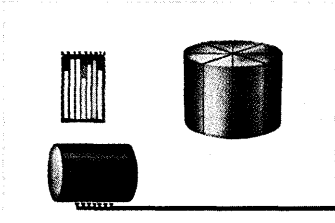

ACE◇ stands for Animated Computer Education◇. It is a powerful new teaching technique. It teaches complex subject matter with simpleness, ease and rapidity. That's why we call it the Super Teacher.

ACE◇ uses animation to depict computer system functions in proper time relationship, even when they happen simultaneously. Relationships are therefore quickly grasped. Concepts are fully understood. And the addition of color and sound to animation reinforces its teaching power.

ACE◇ is the heart of the Edutronics◇ Education System, which consists of a daylight rear-projection viewer, hi-fi earphones, workbook materials and Guidelines for Professional Development◇. With this system an employee learns at his desk on a one-to-one basis in a structured learning environment.

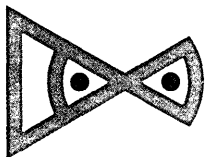

edutronics

Authorized representative:
Edutronics of California, Inc.
2790 Harbor Boulevard, Costa
Mesa, California 92626
(714) 546-1144

Copyright © Edutronics, Inc. 1968

Our training sequence "File Organization, Design and Processing" is available to you and your department now. We'd like to demonstrate its teaching power in your office or send you our new brochure. Write or call.

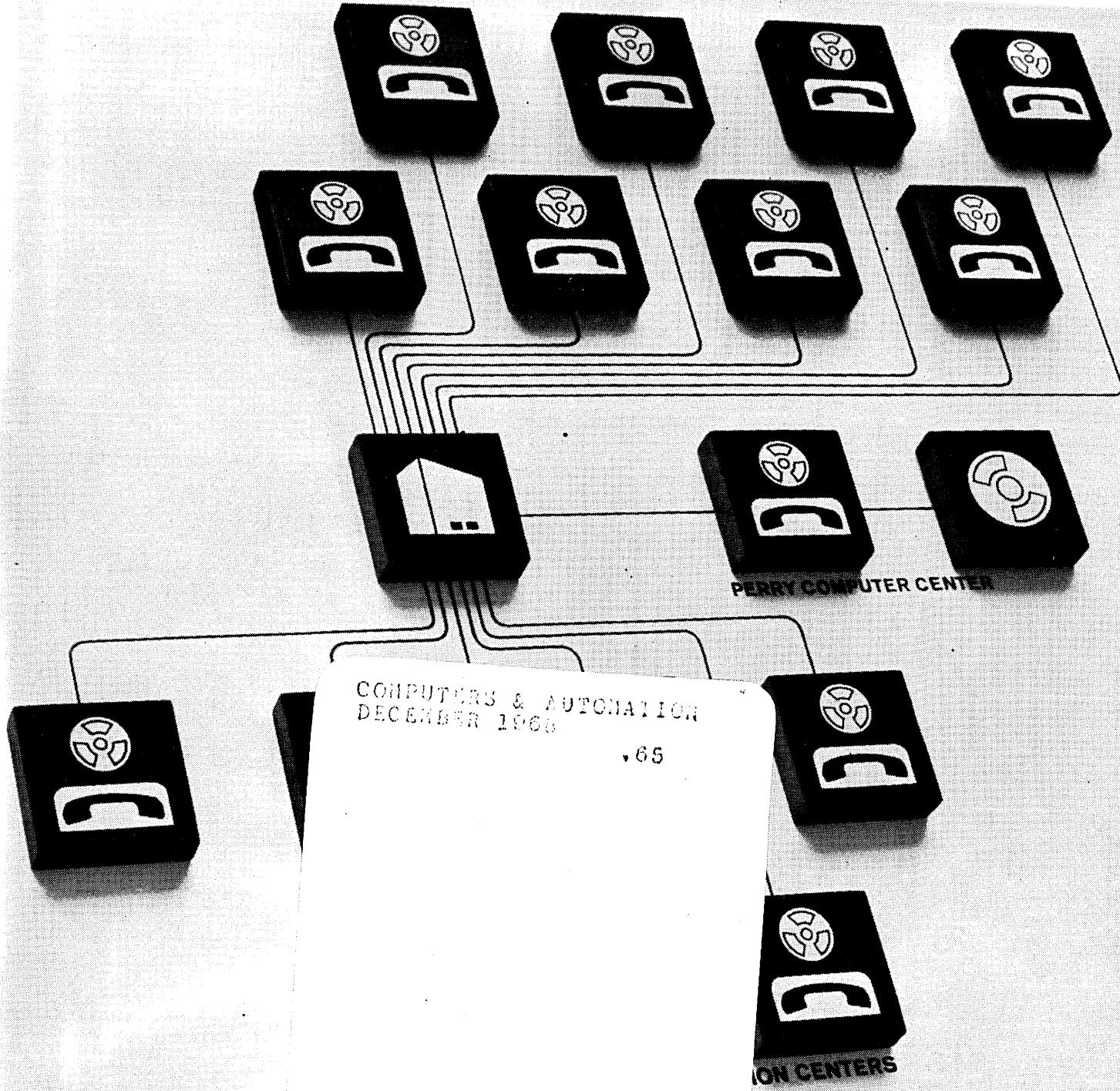

COMPUTERS & AUTOMATION
 DECEMBER 1968 .65

Perry Public is making h

The system was designed so that Florida newspapers could use a central computer center in West Palm Beach.

Every day the Perry paper receives advertising and editorial material which must be prepared for typesetting.

Since speed is essential, a transmitting-receiving center where copy is put on paper tape. Type 2 Dataspeed* Service (one minute) to West Palm Beach.



At the center, tapes are processed by computers at 1000 characters per second.

stem

Computers have a 50,000 character capacity. They are fed into them, so that they can print a newspaper column by column, where necessary. The computer is a new tape drive that provides Dataspeed service and feeds into the printing machines.

A hurry will help you get your computer installed. Our communications Consultants will help you plan a system to beat any deadline.

Mark of the Bell System

-  Dataspeed Service
-  Bell System Central Office
-  Computer

Letters To The Editor

Vol. 17, No. 12 — December, 1968

JOSS

Mr. Norman Doelling, in his article in the October 1968 issue of *Computers and Automation*, comments on general-purpose time-sharing systems as follows:

"Access to machine and assembly languages means that a user can design a language of his own if he desires. In addition, standard languages such as FORTRAN, BASIC, JOSS and COBOL are usually available."

We are writing in reference to possible implications of the use of the name "JOSS" in this context. JOSS is a non-commercial interactive time-sharing system developed at the RAND Corporation, and presently available only to members of the RAND staff and selected Air Force sites.

Several derivatives of JOSS exist, including some commercial languages referred to as "JOSS-like". However, by Trademark and Service Mark, the name "JOSS" is applied at present only to RAND's system.

We hope that this letter will clear up any misunderstanding on the part of readers who may expect to find JOSS available commercially.

SHIRLEY MARKS
R. LAWRENCE CLARK
*Computer Sciences Dept.
The RAND CORP.
1700 Main St.
Santa Monica, Calif. 90406*

Industrial Education

The article, "Innovation in Teaching — Why Industry Leads the Way," by Mr. Newkirk in your October, 1968, issue was very well written. To us in public education, what he said stimulated much thought.

The favorable factors of industrial education programs over public education were certainly well presented. However, there is a distinct difference between the two programs, as he points out, that seems insurmountable. For instance, industry offers programs for a specific business or company while we in public education are given the task of preparing individuals for many different jobs in industry.

Some of his statements raised a question in my mind. The assumption that teachers are smarter than most people seems to be debatable. Because of the nature of the student we have in public education, the learner controlled instruction method may not always be adaptable to the situation.

Other than these points, his article brought out salient points that every educator should read.

DR. WILLARD KORN
*Wisconsin State Univ.
Eau Claire, Wisc. 54701*

Numbles

I enjoyed solving the "Numbler" in your September issue, I was considering what programming techniques to employ for a mechanical solution to this problem, which would operate in an efficient manner. If others have submitted some ideas in that regard, I would appreciate your publishing them in one of your forthcoming issues.

ROBERT A. LIST, *Pres.*
*Robert A. List Corp.
555 Kappock St.
Riverdale, N.Y. 10463*

(Ed. Note — *We hope to receive some "mechanical" solutions to some of our Numbles that we can publish. In the meantime, you might be interested in the letter below.*)

I enclose my solution to Numbler 6810 (page 14, October 1968 issue of C&A). I was planning to put together a whiz-bang time-sharing solution (in the tradition of the GE Mark II), and started to determine a few basic relationships to simplify the programming. As you can see, I decided that human resourcefulness was superior to machine speed. The exercise took a little over a half hour.

JOHN A. BOWEN
*General Electric Co.
Information Service Dept.
7735 Old Georgetown Rd.
Bethesda, Md. 20014*

(Please turn to page 14)

Editor Edmund C. Berkeley

Associate Editor Sharry Langdale

Assistant Editors Moses M. Berlin
Linda Ladd Lovett
Neil D. Macdonald

Contributing Editors John Bennett
Andrew D. Booth
Dick H. Brandon
John W. Carr III
Ned Chapin
Alston S. Householder
Peter Kugel
Leslie Mezei
Rod E. Packer
Ted Schoeters

Advisory Committee T. E. Cheatham, Jr.
James J. Cryan
Richard W. Hamming
Alston S. Householder
Victor Paschkis

Art Directors Ray W. Hass
Daniel T. Langdale

Fulfillment Manager William J. McMillan

Advertising Representatives

NEW YORK 10018, Bernard Lane
37 West 39 St., 212-279-7281

CHICAGO 60611, Cole, Mason, and Deming
737 N. Michigan Ave., 312-787-6558

PASADENA, CALIF. 91105, Douglas C. Lance
562 Bellefontaine St., 213-682-1464

SAN FRANCISCO 94123, Richard C. Alcorn
2152 Union St., 415-922-3006

ELSEWHERE, The Publisher
Berkeley Enterprises, Inc.
815 Washington St., 617-332-5453
Newtonville, Mass. 02160

Editorial Offices

BERKELEY ENTERPRISES, INC.
815 WASHINGTON STREET,
NEWTONVILLE, MASS. 02160



CIRCULATION AUDITED BY
AUDIT BUREAU OF CIRCULATIONS

COMPUTERS AND AUTOMATION IS PUBLISHED MONTHLY AT 815 WASHINGTON ST., NEWTONVILLE, MASS. 02160, BY BERKELEY ENTERPRISES, INC. PRINTED IN U.S.A. SUBSCRIPTION RATES: UNITED STATES, \$15.00 FOR 1 YEAR, \$29.00 FOR 2 YEARS, INCLUDING THE JUNE DIRECTORY ISSUE; CANADA, ADD 50¢ A YEAR FOR POSTAGE; FOREIGN, ADD \$3.50 A YEAR FOR POSTAGE. ADDRESS ALL EDITORIAL AND SUBSCRIPTION MAIL TO BERKELEY ENTERPRISES, INC., 815 WASHINGTON ST., NEWTONVILLE, MASS. 02160. SECOND CLASS POSTAGE PAID AT BOSTON, MASS.

POSTMASTER: PLEASE SEND ALL FORMS 3579 TO BERKELEY ENTERPRISES, INC., 815 WASHINGTON ST., NEWTONVILLE, MASS. 02160. © COPYRIGHT, 1968, BY BERKELEY ENTERPRISES, INC. CHANGE OF ADDRESS: IF YOUR ADDRESS CHANGES, PLEASE SEND US BOTH YOUR NEW ADDRESS AND YOUR OLD ADDRESS (AS IT APPEARS ON THE MAGAZINE ADDRESS IMPRINT), AND ALLOW THREE WEEKS FOR THE CHANGE TO BE MADE.

computers and automation

December, 1968, Vol. 17, No. 12

The magazine of the design, applications, and implications of information processing systems.

Special Feature:

Annual Pictorial Report

- 30 DIGITAL COMPUTERS
- 35 MEMORIES
- 40 COMPONENTS
- 41 PERIPHERAL EQUIPMENT
- 48 DATA PROCESSING ACCESSORIES
- 49 MISCELLANY
- 16 HANDLING SMALL-AREA DATA WITH COMPUTERS

by Richard S. Hanel

Eight important computer capabilities which are available now for handling small-area data . . . some examples of practical applications of these capabilities . . . and some words of caution.

21 AN INTER-CITY, MULTI-ACCESS, TIME-SHARING COMPUTER SYSTEM

by Grant N. Boyd

How the computing capabilities of one company grew over a period of ten years, during which the number of its research and development employees increased from 100 to over 1700.

25 AUTOMATED RETRIEVAL OF LEGAL INFORMATION: STATE OF THE ART

by Stephen E. Furth

How computerized legal or statutory search systems are proving to be reliable, time-saving, and money-saving.

Regular Features

Editorial

- 6 Access to a Computer for Every Computer Person — Are We There?, by Edmund C. Berkeley

C&A Worldwide

- 55 Report from Great Britain, by Ted Schoeters

Fifteen Years Ago in Computers and Automation

- 52 The Flood of Automatic Computers, by Neil Macdonald

Ideas: Spotlight

- 53 IBM Technician Has \$75,000 Idea

Jobs and Careers in Data Processing

- 50 Needed: Peopleware, by Swen A. Larsen

Multi-Access Forum

- 8 "How to Spoil One's Mind — As Well As One's Computer" — Some Comments, by C. W. Chamberlain, S. G. Topham, Robert F. Utter, Robert W. Trenn, and the Editor
- 10 Evaluating EDP Service Bureaus — and Consulting Firms, by Dennis D. Sheaks
- 12 Are Computer People the Tools of Their Tools?, by James R. Gigone
- 12 Detecting Proofreading Errors Without a Computer, by John H. Reddersen
- 13 Calls for Papers: International Joint Conference on Artificial Intelligence, May 1969; Sixth Annual Design Automation Workshop, June 1969; and Seventh Annual Conference of the Special Interest Group on Computer Personnel Research, of the Association for Computing Machinery, June 1969
- 13 Who's Who in the Computer Field, 1968-69 — Entries

December, 1968

computers and automation

City of the Future?

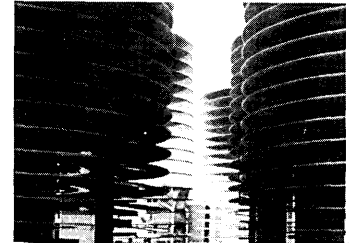

The picture on the front cover might be showing a city of the future — but it actually shows several stacks of magnetic disks for recording information, awaiting assembly at Honeywell Electronic Data Processing Division in Newton, Mass. For more information, see page 49.

Departments

- 56 Across the Editor's Desk — Computing and Data Processing Newsletter
- 70 Advertising Index
- 54 Calendar of Coming Events
- 63 Financial and Business News
- 4 Letters to the Editor
- 66 Monthly Computer Census
- 64 New Contracts
- 65 New Installations
- 70 New Patents
by Raymond R. Skolnick
- 28 Numbles
by Neil Macdonald
- 69 Problem Corner
by Walter Penney, CDP
- 15 Proof Goofs
by Neil Macdonald

Access to a Computer for Every Computer Person — Are We There?

Sometimes it is hard to realize the extent to which some condition is changing. A few years ago, most people in the computer field did not have access to a computer. Yes, they talked about computers, they studied computers and the jobs that computers could do, they wrote about computers, their applications, their construction, and design, they published magazines and even books about computers, etc. But they themselves did not have access to a computer.

It has become clear that this situation is entirely changing.

One of the questions on the entry form for our *Who's Who in the Computer Field* (which we have recently mailed to 40,000 addresses and to which we have received several thousand replies) is the following one:

Do you have access to a computer? () Yes () No

a.) If yes, what kind of a computer?

Manufacturer? _____

Model? _____

b.) Where is it installed:

Organization? _____

Address? _____

c.) Is your access: Batch? () Time-shared? ()

Other? () Please explain _____

d.) Any remarks? _____

To get a peep at the eventual results, we examined a sample of 200 replies, and tabulated some of the answers.

Although these figures must be taken with salt, yet it seems reasonable with this evidence to believe that, for a population of persons who consider themselves to be computer people (to the extent to be included in *Who's Who in the Computer Field*):

- Almost all computer people now have access to a computer;
- Approximately one third of them have time-shared access to a computer;
- The average number of computers to which they have access is closer to 2 than to 1.

Of course, there is a little ambiguity to the question "Do you have access to a computer?"; different people will have different meanings in mind. But if the respondent says, "Yes, I have access to a computer", then he essentially means: (1) there exists a computer or a computer console in his neighborhood; (2) for a business or professional problem that he wants to give to that computer, he can do so, and get solutions to his problem. It may well be that he is restricted to certain kinds of problems — that if, for example, he should want to play a game with a computer, he may not have access to a computer that will play a game with him. But at least for the class of problems that he is essentially concerned with, he himself is satisfied that he can get competent problem-solving service from the computer.

Increased access to computers is all to the good. For understanding a machine or a system, there is no satisfactory substitute for actual access to it, whether it's a car or a printing press — or the most remarkable new system of the 20th century, the automatic computer. Having access to a computer, working with it, learning a kind of language which it will listen to, is an experience of great value.

Table 1

ACCESS TO A COMPUTER

	<u>Number</u>	<u>Percent</u>
Persons with access	196	98%
Persons without access	<u>4</u>	<u>2</u>
Total in sample	200	100%

Table 2

COMPUTERS TO WHICH PERSONS HAVE ACCESS

	<u>Total Number</u>	<u>Average Number per person with access</u>
Computers accessible	325	1.66

Table 3

TYPES OF ACCESS

	<u>Number</u>	<u>Percent</u>
Persons reporting batch access	162	83%
Persons reporting time-shared access	63	32
Persons reporting other kinds of access (such as "remote batch, real-time, direct access, full-time, hands-on depending on time of day, multi-processing", etc.)	38	19

Computers provide a lesson in accuracy for human beings. If the machine is instructed inaccurately, it will usually continue to do the wrong thing many millions of times, until someone notices the wrong or impossible answer.

Computers also provide a lesson in completeness, another lesson that human beings find hard to learn. If you happen to leave out something that you want the computer to do, then it won't guess what you mean and do that. Only human beings, it seems, have this desirable attribute.

Computers provide instruction in logical thinking. It is hard for a human being to be logical. It is the essence of a computer to be logical.

And finally, computers provide an incentive to use one's imagination. Imagination is needed to analyze and to program. Imagination is needed to design small model versions of problems, small systems, for testing the program — so that the program becomes more and more likely to operate correctly on large, full-size, real-life systems.

Edmund C. Berkeley
Editor

Are disk pack rentals taking a big bite out of your budget?

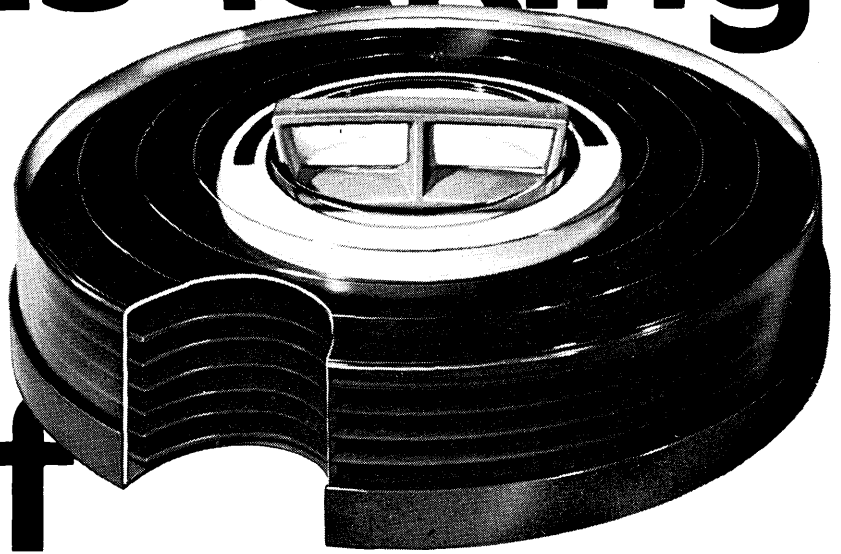

LEASE THEM FROM CPU.

Computer Packs Unlimited can reduce your disk pack rental expenditures by buying your existing packs and leasing them back to you. Write for our brochure

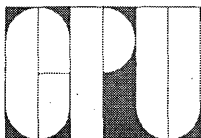

Computer Packs Unlimited

Computer Packs Unlimited has Agents in the following cities:

New York, Boston, Cleveland, Memphis, South Bend, Cincinnati, Minneapolis, Milwaukee, Los Angeles, Chicago.

a subsidiary of Computer Processing Unlimited/232 East Ohio Street/Chicago, Illinois 60611

Designate No. 18 on Reader Service Card

MULTI-ACCESS FORUM

"HOW TO SPOIL ONE'S MIND — AS WELL AS ONE'S COMPUTER" — SOME COMMENTS

The August issue of "Computers and Automation" contained an editorial with the above title. It discussed the problem of "garbage in" to computers and "garbage in" to human minds, and the problem of "big and important lies", told by various groups such as the cigarette industry and even on occasions by the United States Government since 1960. A list of a dozen big and important lies told by the United States Government was mentioned; some readers asked for it; some of their letters follow.

I. From C. W. Chamberlain, M.D. Richmond, Va. 23221

In your editorial in the August 1968 issue of "Computers and Automation" you stated that a list of "at least a dozen big and important lies" told by the United States Government from 1960 to the present, would be furnished by you on request. I am requesting this list.

I wonder if you also have lists of "big and important lies" told by governments other than the United States? It would be interesting to compile lists like this for some or all of the leading governments. Why confine yourself when making up lists to only the U.S., or is this the way you are programmed?

II. From S. G. Topham Salt Lake City, Utah 84103

May I compliment you on the exceptional editorial appearing in the August, 1968 issue of "Computers and Automation"? It was well written and extremely thought provoking.

Would it be possible for you to send me a copy of the editorial?

Also, in the editorial you referred to President Johnson's "credibility gap" and stated that a list of his untruths would "be furnished by the editor on request". Would you please send me a copy of that list by return mail? Enclosed you will find a self-addressed, stamped envelope. If there is any additional cost for either the editorial or "credibility gap" list, please bill me.

III. From Robert F. Utter Albuquerque, New Mexico 87110

I especially enjoyed your lead editorial in the August issue of "Computers and Automation". I would appreciate receiving your list of government lies.

With you, I think that a drastic loss of public confidence in official statements can only lead to a progressive decay in the ethics of our system.

IV. From Robert W. Trenn New York, N.Y. 10005

Re: Your August editorial
Congratulations. Please send me the list of lies.

V. From the Editor

The more that we consider the great power of computers and the inclination of people to put trust in the results produced by computers, the more we need to become concerned with the truthfulness of the output. It seems to me important that any person who looks upon himself as a computer professional should consider his responsibility for producing the truth, — or contributing to its production.

As the editorial said, "even if there is often some question about what is the precise truth, there is usually no doubt whatever about what is a big lie".

The memorandum that was sent out to those persons asking for the list contained the following introduction:

This is a preliminary compilation of over a dozen big and important lies told by a government. Essentially such a lie told by a government requires these elements:

- 1) The government giving out the information knows that the information is false or materially misrepresents the facts;
- 2) The government issues the false information in order to seek to produce a result which that government desires;
- 3) The government issuing the information believes that the people it governs would seriously disapprove if the truth were told;
- 4) The government intends to keep the truth secret, but if and when the truth comes out, the government relies on confronting its people with a fait accompli, excuses, or more lies, and so on.

In the case of governments which are dictatorships by either one person or by a small group, sensible men do not expect the truth to be told. For example, Egypt announced to its people, after its defeat by Israel in the 1967 six-day war, that American and British planes had joined with Israeli planes to destroy the Egyptian air force. This was a colossal lie — but not really to be unexpected since Egypt is a dictatorship.

In the case of the United States, officially the government is a democracy, and is supposed to be elected by the people as the people's servant and not its tyrant. So here in the

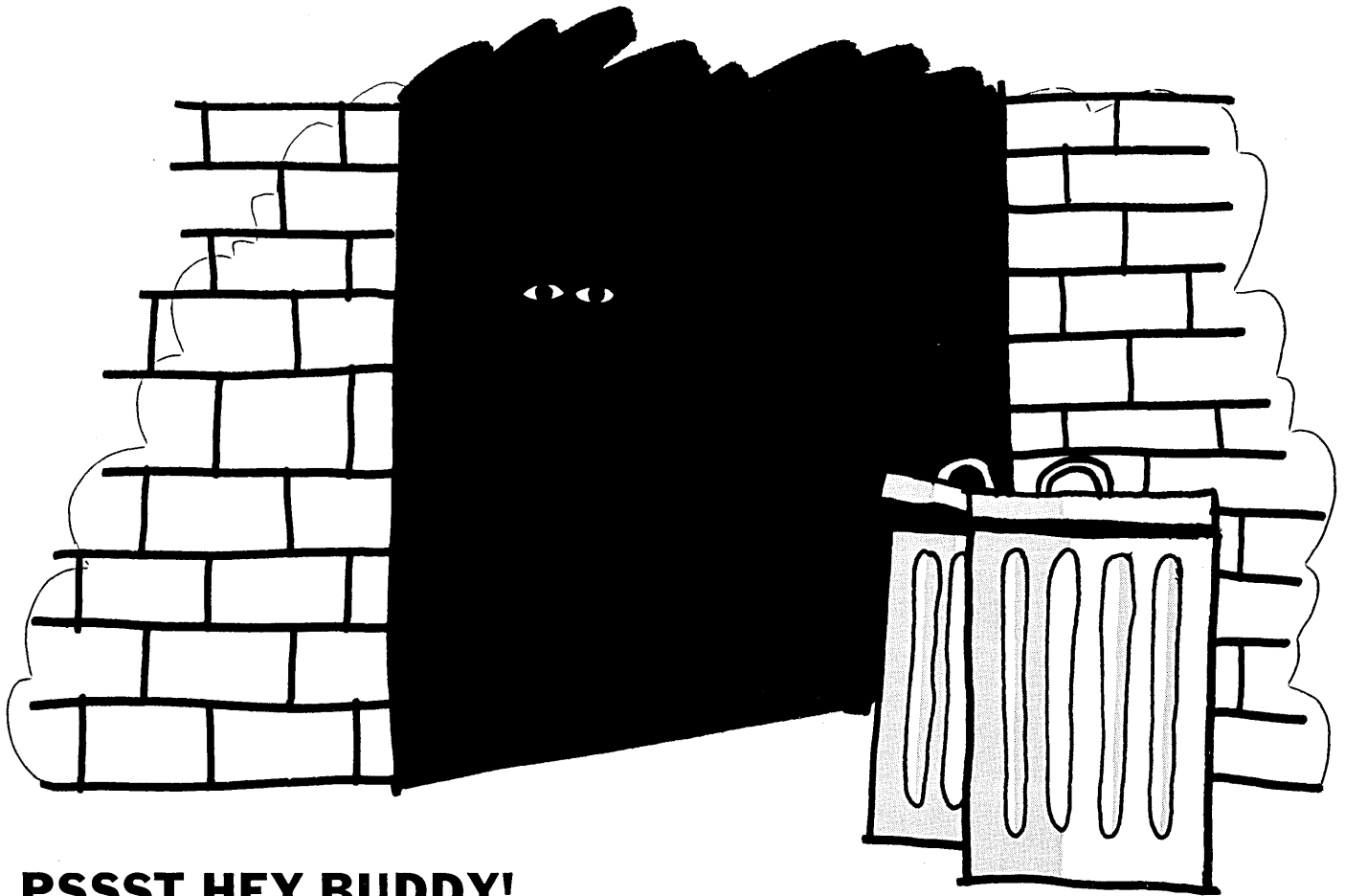

PSSST HEY BUDDY!
You say you're looking for a good deal on a 24 bit computer for less than 17k. SCC's got it... just tell 'em Max sent you.

With over 70 systems installed, the word is getting around. SCC's 24-bit machines are compatible with the programs you've been using.

For \$16,800 you can own the 660 CPU with 59 instructions including a set of microinstructions. For \$35,500, SCC offers the 670 with 71 instructions that also include a comprehensive set of microinstructions for performing data transfers and logical and arithmetic operations. These fully parallel machines provide either single or multiple as well as simultaneous access to memory.

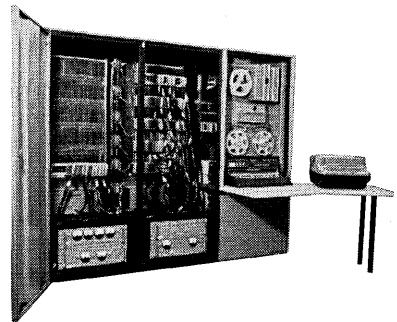

If you're looking for a computer system, SCC can give you 30-day delivery on a 660 CPU, a 1.75 usec memory with parity, memory adapter, character buffer I/O, 300 cps P.T. reader, 50 cps P.T. punch and Selectric typewriter with 8" platen.

Now that you have the word. . . you'll know where to come.

Whatever Your Computer Application — Be Sure You Talk With SCC Before You Buy



Scientific Control Corporation

P.O. Box 34529 • Dallas, Texas 75234 • 214 — 241-2111 • TWX 910-860-5509

EASTERN REGION: College Park, Md.
 Huntsville, Ala.
 Parsippany, N. J.
 West Springfield, Mass.

CENTRAL REGION: Dallas, Tex.
 Denver, Col.
 Des Plaines, Ill.
 Hazelwood, Mo.
 Houston, Tex.

WESTERN REGION: Palo Alto, Calif.
 El Monte, Calif.

Designate No. 11 on Reader Service Card

United States, it is officially reasonable to expect the government to tell the truth because only in that way can a democratic government really serve its people. When the important truth is systematically concealed, and lies are systematically told instead, sensible people must change their way of thinking, and plan and act accordingly.

One of the most undesirable results of systematic lying by a government is that the government, which originally began to tell lies to its people, winds up by believing a great many of the lies itself. So its actions become more and more unrelated to reality, the decisions taken become more and more absurd, the money wasted becomes more and more huge, the mistakes made become more and more gigantic, and finally a day of reckoning arrives which is disastrous beyond words. This was the fate of the Hitler government of Nazi Germany in 1945. An ancient maxim declares, "Those whom the gods would destroy they first make mad".

If the American people continue to allow themselves to be told lies systematically, day in and day out, from the government and many other sources, a most evil day of reckoning lies ahead. One of the possible results is the nuclear holocaust, in which hundreds of millions of human beings are killed in a large-scale nuclear war.

People who want to see the United States really prosper and really become great should do their best to reestablish standards of telling the truth and not lying, in the United States, in all fields of government, industry, business, etc.

The memorandum had for Table of Contents:

1. The U2 Flight over the Soviet Union
2. The Bay of Pigs Invasion of Cuba
3. Adlai Stevenson on the Bay of Pigs Invasion of Cuba
4. Arthur M. Schlesinger, Jr., on the Bay of Pigs Invasion of Cuba
5. "1500 Murders" in the Dominican Revolt
6. U.S. Support of the Junta in the Dominican Revolt
7. A Bribe to the Prime Minister of Singapore
8. "Aggression" in Vietnam and "Going Home"
9. Willingness by the United States to Negotiate Peace in Vietnam

EVALUATING EDP SERVICE BUREAUS — AND CONSULTING FIRMS

Dennis D. Sheaks
Marketing Manager
Computer Usage Development Corp.
200 S. Mich. Ave.
Chicago, Ill. 60604

In the August issue of *Computers & Automation* Mr. I. J. Kusel from Walter E. Heller & Company had written to you asking for advice on procedures for evaluating consulting firms. Your response was to use some observations from a previous issue of C&A on "How to Choose and Use an EDP Service Bureau". I feel that if you are categorizing the consulting firms that Mr. Kusel was referring to with EDP Service Bureaus, you are not being fair to either type organization. Advice and consultation cannot be sectioned off and measured in the same way as a block of computer time.

Your advice dwelled on three parts.

1. One-man service bureaus
2. One-machine operation
3. The free survey

I would like to discuss these in order. I agree the one-man service bureau is risky if the man in fact does control the job on a continuous basis. However, depending on the type of application, you might not be interested in long-term service

10. The Cost of the Vietnam War
 11. The Nature of Targets Bombed in North Vietnam
 12. Extent of the Use of Roads in South Vietnam as a measure of American Military Success
 13. The 1967 Elections in South Vietnam
 14. Stopping of the U.S. Bombing of North Vietnam
 15. Arthur Sylvester on the Government's Right to Lie
- Appendix 1. Bibliography
Appendix 2. "Some Stumbling Blocks in Following LBJ Logic", by James Doyle of the *Boston Globe*
Appendix 3. Editorial from the August issue of *Computers and Automation*, "How to Spoil One's Mind as Well as One's Computer"

One of the major problems confronted by the peoples of the United States and other countries is the telling of big and important lies, colossal lies, by groups of persons including governments, businesses, political parties, vested interests, etc., of many kinds here and there all over the world. One of the lies that sticks in my mind is the lie told by the Soviet Union in 1940 that the Germans and not the Russians had put to death 12,000 Polish army officers and men in the Katyn Forest in May of that year; but the evidence is clear that the Soviet secret police shot them there under Stalin's orders. However, sensible men would not expect unflattering truth to be told voluntarily by the Stalin dictatorship.

People who live in small countries like Denmark or Switzerland are regularly much better off for news and information than people who live in big countries like the United States or the Soviet Union. Perhaps one of the best ways to escape from the all-pervasive distorted atmosphere of news reported and beliefs held in a large country is to travel for a while in other countries, especially smaller ones. And the more powerful and pervasive computers become, the more necessary it is for computer professionals to take on added responsibility to seek to produce truthful computer output. ■

for that particular area of assistance. If, for instance, you contracted with a "one-man shop" to perform an evaluation of your computer department and its objectives, your end product after several months of endeavor would probably be a logically organized master plan in the form of a typewritten report. At this point the consultant's services end. The report is self-contained, such that it is understandable and solutions are well identified with suggestions as to the procedure to follow. If the job is one that will require continuous control, the benefit of using a larger firm is to have back-up and assurance that the job will eventually be done at no additional cost due to changes in personnel, i.e., the man quit. However, if you have a schedule problem, this is of little consultation. Therefore, my suggestion to your first point is that in any case you must have confidence in the people with whom you are dealing.

The second point that you presented has no bearing on most "pure" consulting jobs. However, because most consulting firms do a large portion of programming and analysis,

Who said a computer shouldn't get promoted from within?

All day long you manage a computer installation, and what happens? Management thinks the computer's a genius and you're its assistant.

This situation could go on indefinitely unless you do something a computer couldn't possibly do. Like promote a better deal on computers to your management.

For example, you can buy "used" computers for as little as 25% of new cost, perhaps saving your company hundreds of thousands of dollars.

Machines are available with known technical ability that have huge, easily accessible libraries of programs. And with hundreds of people already trained in their operation and programming.

IBM recently announced a new policy that brings hard security to machines as they move from user to user. It pro-

vides subsequent owners of IBM machines with the same maintenance, education, Programming Systems Maintenance and site planning as the original buyer. Other manufacturers aren't far behind.

Certainly, there are jobs that require the unique capabilities of Third Generation equipment. We can even help there. But, if you're to get everything out of these new machines that they have to offer, using a low-cost Second Generation satellite system represents an important economy—for example, excess printing load and/or periodic management reports.

If what you need is more capacity and/or capability for your present Second Generation system, there's no more efficient way to get it than through The Computer Exchange.

Even those contemplating their first computer should examine this new alternative.

Talk to us, and the only problem you'll have is how to spend the extra

money you'll be saving to build your department.

What about surplus equipment? That's no problem either. Because The Computer Exchange operates like any other exchange, commodity or stock. If it has value, we'll buy it.

So if you'd like to know what you should buy or what you should sell, or what the right market price is for equipment, or how to lower cost and increase performance, or what's available, or anything and everything about "used" computers, you can't find a better informed group of computer people who talk your language.

Give us a call. Or stop in. Or let us stop by to see you. We'll help you promote a computer and outsmart it at the same time.

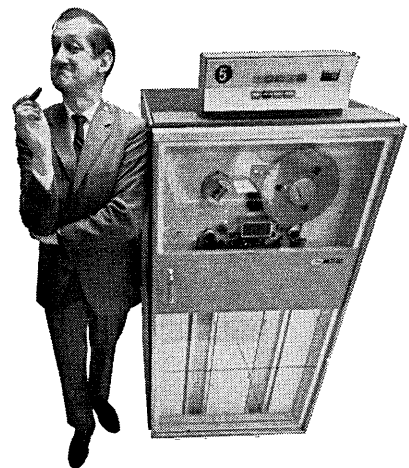

THE COMPUTER EXCHANGE INC.

30 East 42nd Street, New York, N.Y. 10017

(212) 661-5870

Designate No. 12 on Reader Service Card

it is true that they must have computers for program development. The way you presented your point indicates you are only talking about servicing or processing a production program. Most consulting firms generally do not provide a service bureau type operation. Those that do usually have them operate on a completely independent basis. Therefore, I believe point two has no reflection or contribution to the evaluation of a consulting firm.

In point three you suggest that a free survey is a gimmick; this I will most certainly agree to. But who says gimmicks are bad? You suggest that adequate surveys require the services of expensive specialists; indeed they do. However, nobody realizes the expense of these specialists as much as the consulting firm when there are no jobs contracted for which you can use his specific talent. Therefore, you begin to eat the cost. It is only good business to use this man's knowledge in the promotion of more business if he is not already billable. Many times a client is hard to convince of an existing prob-

lem and he certainly is not willing to pay for an analysis of a non-existent problem (at least in his eyes). Therefore, if we see the possibility of aiding this man by merely identifying the problem for him, we are more than happy to provide the services of a specialist to work with him (and eventually generate more business).

My suggestion for selecting a consulting firm is reliance. If this has to be established from a non-existent base, then you can only go by proven history or by proven records. Naturally, the first requirement is that they can do the job. This should be established from experience that can be verified. Once you have used satisfactory services or know of others who have used services that are quite reliable, the best procedure is to continue using that service (but keep them on their toes with some keen competition occasionally!). Until standards are established by which all consulting firms must abide, this will remain your only method of operation. ■

ARE COMPUTER PEOPLE THE TOOLS OF THEIR TOOLS?

James R. Gigone
Four Mile Canyon
Boulder, Colo.

"Men have become the tools of their tools" (from "The Thoughts of Thoreau" by Edwin Way Teale).

Data processing professionals spend a good deal of time contradicting this philosophy.

One of the first facts we point out to those unfamiliar with the data processing field is that computers only do what they are told to do by the programmers and operators. In practice, however, organizations can become dependent upon data processing programs and systems which sometimes produce strange and unpredictable results.

In these cases the data processing personnel are kept busy and tense with stop-gap measures to get the job out. Those using the output also may have fears concerning accuracy of data and the ability to meet important deadlines. In this case, as Thoreau warned more than a century ago, the computer system does to some extent run the people.

This unfortunate circumstance can be brought about in several different ways. A few of the causes are: (1) inadequate education prior to the development of a system; (2) a myriad of changes since the development of the system; (3) "quick and dirty" conversions; (4) poor documentation and weak backup; and (5) an employee who likes the feeling of "security" resulting from non-communication.

Most people in the data processing field have at some time or another been in the situation where they did not feel fully in command of their area of responsibility. However, our ethics should demand that when faced with this situation we take steps to remedy it—that we force ourselves to document; that we strive to obtain adequate education; or, if necessary, we request management to slow down the conversion. To provide good service we must run, rather than be run by, our data processing tools. ■

DETECTING PROOFREADING ERRORS WITHOUT A COMPUTER

John H. Reddersen
The Mutual Life Insurance Co. of New York
Broadway at 55th St.
New York, N.Y. 10019

As an assistant director for insurance policy forms, I have a natural abhorrence of any kind of errors which, in our end of the business, just can't be afforded. Knowing of my interest in this field, one of my colleagues passed along to me your September 1968 issue containing your editorial on errors.

I suspect that your primary interest is in the possibly far-out project of a computer programmed to detect errors. A woeful lack of knowledge on my part of computers and programming leaves me completely in the dark in that respect. In the general area of detecting errors in typewritten or printed material, however, you may find the following comments of interest:

1. We employ a "for sense" reading by a responsible person after all proofreading has been completed. This may be the same thing as the inspection you speak of but a more extensive review is connoted. It helps show up such sentences or facts not hanging together properly, absence or

overuse of punctuation, omission of closing parentheses and quotation marks, etc., as well as the ever-present "typos".

2. Many people read printed or typed material for what they want or expect it to say, rather than for what it does say, especially in these days when emphasis is on speed reading. Thus, "reuntied" is misread as "reunited" because the latter is intended and expected (your Proof Goof 6891). It takes real concentration to avoid this pitfall.

3. People who read printed or typed material must be good spellers or at least know when to check with the dictionary. This is what I had to do on the misspelling of "terrestrial" (Proof Goof 6892).

4. Headings have a tendency to be missed or skimmed over, especially when they are added at the last minute to break up lengthy text. The result is that they contain typographical errors or inaccurately describe the text which follows.

5. The best way to avoid printing errors to begin with, and the chance of their not being caught, is to be sure that the printer or typesetter gets clear copy with complete instructions as to type font, size of type, bold face and light face, etc., and with any corrections clearly written or typed. Give a printer a tiny opportunity to use his judgment and, not being familiar with the subject generally, he will proceed to "go to town". ■

CALLS FOR PAPERS

I. International Joint Conference on Artificial Intelligence, May 1969

The subject areas for this conference, to be held May 7-9, 1969 in Washington, D.C., have been selected. Papers are requested in the following areas: Theoretical Foundations of Artificial Intelligence; Theorem Proving; Heuristic Problem Solving; Question-Answering Systems and Computer Understanding; Man-Machine Symbiosis in Problem Solving; Psychological Modeling; Linguistic Research Relevant to Artificial Intelligence; Integrated Artificial Intelligence Systems; Self-Organizing Systems; Pattern Recognition — Signal Processing; Pictorial Pattern Recognition; Linguistic and Contextual Methods in Pattern Recognition; Physiological Modeling; and Applications of Artificial Intelligence Work.

Manuscripts are due January 15, 1969. Manuscripts and inquiries about the program should be sent to: Dr. Donald E. Walker, IJCAI Program Chairman, The MITRE Corp., Bedford, Mass. 01730.

II. Sixth Annual Design Automation Workshop, June 1969

This workshop, jointly sponsored by SHARE, ACM and IEEE, is scheduled for June 8-12, 1969, in Miami Beach, Florida. Authors are invited to submit papers of interest in the general area of Design Automation, which includes the use of computers in design, analysis and synthesis. Topics would include: electronic design; computer techniques for design; simulation; man-machine interaction; process automation; mechanical design; and management information and control.

Interested authors should submit three copies of a 1,000 word abstract prior to January 2, 1969 to the Program Chairman: Dr. H. Freitag, IBM Watson Research Center, P.O. Box 218, Yorktown Heights, N.Y. 10598.

III. Seventh Annual Conference of the Special Interest Group on Computer Personnel Research, of the Association for Computing Machinery, June 1969

This conference will be held in Chicago, Ill., June 19 and 20, 1969. Papers are solicited describing relevant research in the general areas of: (1) Selection criteria and training programs for the disadvantaged for entry level jobs in the computer profession; (2) Programmer performance evaluation techniques and approaches; (3) Description of job content and selection procedures for systems analysts positions; (4) Approaches to the supervision of programming personnel and the management of computer installations; (5) Governmental guidelines for all jobs in the computer profession; (6) Mobility and turnover of computer personnel; and (7) Any specialized proficiency tests for programmers and systems analysts.

Authors should submit three copies of a 300-word summary of their research by February 1, 1969 to: Dr. Charles D. Lothridge, General Electric Co., 570 Lexington Ave., New York, N.Y. 10022. ■

add the features and you won't believe the low price of the new series MDM-X digital computer memories

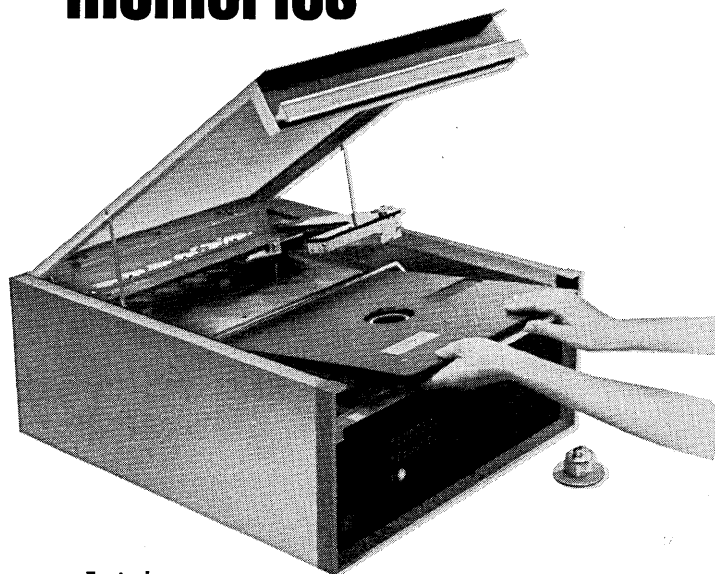

Featuring:

- * Processing **both** surfaces simultaneously
- * **Random** access positioners
- * 25 million bit **on-line** storage capacity
- * 25 milliseconds maximum **mechanical** access time
- * Interchangeable magnetic disc cassettes
- * Modular construction
- * Fast, fool-proof leading; remove and replace cassettes in less than 10-seconds

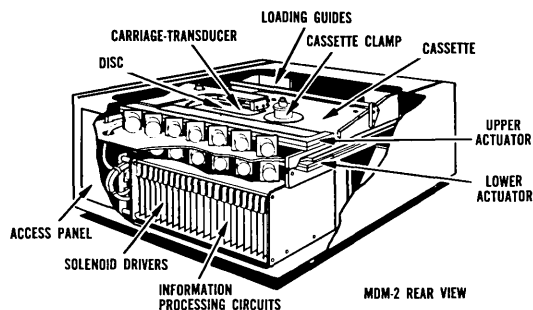

For complete information, consultation, and quotations contact:

INFOTECHNICS, INC.

15730 Stagg Street, Van Nuys, California 91406
phone: (213) 787-0401 or 780-3615

WHO'S WHO IN THE COMPUTER FIELD, 1968-1969 — ENTRIES

Who's Who in the Computer Field 1968-1969 (the Fifth Edition of our Who's Who), will be published by Computers and Automation during 1969. The Fourth Edition, 253 pages, with about 5000 capsule biographies was published in 1963. The Third Edition, 199 pages, was published in 1957.

In the Fifth Edition we hope to include upwards of 10,000 capsule biographies including as many persons as possible who have distinguished themselves in the field of computers and data processing.

If you wish to be considered for inclusion in the Who's Who, please complete the following form or provide us with the equivalent information. (If you have already sent us a form some time during the past eight months, it is not necessary to send us another one unless there is a change in information.)

WHO'S WHO ENTRY FORM (may be copied on any piece of paper)

1. Name? (Please print) _____
2. Home Address (with Zip)? _____
3. Organization? _____
4. Its Address (with Zip)? _____
5. Your Title? _____
6. Your Main Interests?

Applications	()	Mathematics	()
Business	()	Programming	()
Construction	()	Sales	()
Design	()	Systems	()
Logic	()	Other	()
Management	()	(Please specify)	

7. Year of Birth? _____
8. Education and Degrees? _____
9. Year Entered Computer Field? _____
10. Occupation? _____
11. Publications, Honors, Memberships, and other Distinctions? _____

(attach paper if needed)

12. Do you have access to a computer? () Yes () No
 - a. If yes, what kind of computer?

Manufacturer	_____
Model	_____
 - b. Where is it installed:

Manufacturer?	_____
Address?	_____
 - c. Is your access: Batch? () Time-shared? () Other? () Please explain: _____
 - d. Any remarks? _____

13. Associates or friends who should be sent Who's Who entry forms?

Name and Address

(attach paper if needed)

When completed, please send to:

Who's Who Editor, Computers and Automation,
815 Washington St., Newtonville, Mass. 02160

Letters to the Editor

(Continued from page 4)

Proof Goofs

Computers and Automation has long been a favorite of mine among ADP journals. I read your September editorial with considerable interest as I have always been aware of "proof goofs" and have been constantly amazed at how some of them slip by.

Frequently I am reminded of an experience in my eighth grade history class when a female classmate stood up to give an oral report on the McCormick *rapeing* machine — absolutely straight-faced and innocent of her utterances.

In addition to the goofs in your "Proof Goof" column in September, I also found an error in the IFIP Congress report on page 10, column 2, in the quote of Alexander Douglas: "Tyranny is tolerable . . ." should be "Tyranny is tolerable . . .".

Was this done purposely, just to see how sharp your readers are?

I realize this letter may be received

latter than most, but I'm just a pore buoy surfing as a computer programmer for Uncle u-no-hoo. (I get my copy of your magazine through the SSA library on a circulation basis and, needless to say, I'm not #1 on their list.) Maybe some day I'll be able to afford your subscription rates.

Keep up the good editorials.

PHILIP L. SIBERT
3602 Forest Grove Ave.
Baltimore, Md. 21207

(Ed. Note — *The error in "tyranny" was not intentional.*)

Another kind of error is an error in research, where the innocent fact-gatherer is solemnly assured of something which turns out to be completely wrong. For example, I found the following on page 1813 of *Webster's Third New International Dictionary* (Merriam-Webster, 1961): "PROGRAM-

MER . . . 2. A component unit in a computing machine or accounting machine that stores the program and controls the sequence of operations."

Or should we consider this a prediction of future technological unemployment for members of our profession?

T.D.C. KUCH
4242 East West Highway
Chevy Chase, Md. 20015

"Proof Goofs" is irresistible, but the 20 lines before and after which you require makes the error rather easy to spot, besides using up space that could better be used to accommodate more "goofs". I would suggest limiting the context to 150-odd words and not specifying the thickness of the insulation on either side.

ROLAND MANN
20th Floor
245 Park Ave.
New York, N.Y. 10017

PROOF GOOFS

Neil Macdonald
Assistant Editor

We print here actual proofreading errors in context as found in actual books; we print them concealed, as puzzles or problems. The correction that we think should have been made will be published in our next issue.

If you wish, send us a postcard stating what you think the correction should be.

We invite our readers to send in actual proofreading errors they find in books (not newspapers or magazines). Please send us: (1) the context for at least twenty lines before the error, then the error itself, then the context for at least twenty lines after the error; (2) the full citation of the book including edition and page of the error (for verification); and (3) on a separate sheet the correction that you propose.

We also invite discussion from our readers of how catching of proofreading errors could be practically programmed on a computer.

For more comment on this subject, see the editorial in the September 1968 issue of *Computers and Automation*.

Proof Goof 6812

Find one proofreading error:

Comparable sets are also composed of different components in different cultures. We think of a set of china as being primarily the dishes, cups, and saucers made from the same material and bearing the same pattern or in the same style. In Japan this does not hold. One of the many sets which I saw in the modern department stores in the Ginza was a "coffee set" in a box. It included five cups, five saucers, five spoons (all china), one aluminum percolator (kitchen variety), one cut-glass cream pitcher, and one plain sugar bowl with a plastic top. In the United States, no stretch of the imagination could put these diverse items in the same set.

Another important point is that the same sets are *classified differently* as one moves about the globe. This provides us with some additional stumbling blocks and gives us the illusion that we are really learning something different. In English, nouns are not classified as to sex. In Arabic, they are. You have to know the sex of the noun if you are to use it properly. We, on the other hand, classify everything into animate and inanimate, which would mean that a Trobriand Islander who does not make these distinctions would have to remember every time he referred to something whether we thought it was alive or not. He would also experience some difficulty with our animal and vegetable classifications, because he conceives of vegetables as being like animals and able to migrate from one garden to the next. (A good gardener to him is like a shepherd who is able to keep his own vegetables home and possibly even to entice a few, but not too many, of his neighbor's vegetables to enter his garden.)

English also has mass and non-mass nouns. Mass nouns comprise such things as sand, snow, flour, and grass. They are indicated by the phrase, "Give me some —." Non-mass nouns include such objects as man, dog, thimble, and leaf. The phrase, "Give me —" is the linguistic clue to their existence. The foreigner always has to learn, pretty much by

ANNOUNCEMENT

Beginning January 1, 1969 *Computers and Automation* will be published 13 times a year instead of 12 times. The new June issue will have the same kind of editorial content as the other monthly issues; and "The Annual Computer Directory and Buyers' Guide" issue will become a special 13th issue published additionally in June.

Effective February 1, 1969, the annual subscription rate for *Computers and Automation with the "Computer Directory and Buyers' Guide"* will become \$18.50 a year, and *without the Directory issue* will become \$9.50 a year, for United States subscriptions.

Since 1960 our subscription rates have been unchanged. But because of the additional issue we will publish and because of continually increasing costs of producing and publishing the magazine, this price increase has become necessary.

rote, which nouns are mass and which are not. Grass is, leaf isn't; there is no known consistent logic as to why a noun exists in one category and not another. In fact, it is true of sets generally that there is a good deal of plain old repetitious learning involved in their use. Vocabulary, wherever and however you find it, always has to be memorized.

We also distinguish between the various states of things — that is, whether they are active or passive. How the person speaking relates to natural events also varies. We say, "I'll see you *in* an hour." The Arab says, "What do you mean, 'in an hour'?" Is the hour like a room, that you can go in and out of it?" To him his own system makes sense: "I'll see you before one hour," or "I'll see you after one week." We go out *in* the rain. The Arab goes *under* the rain.

Not only are sets classified, but they are broken down into further categories. An analysis of the number of sets in a given category can sometimes tell you the relative importance of an item in the over-all culture. The first person to speak scientifically about this trait was Franz Boas in his discussion of such things as the Eskimo's use of several different "nouns" for the many states of snow. In our culture one can get some idea of the importance of women by examining the tremendous proliferation of synonyms for females, particularly the young ones — cupcake, doll, flame, skirt, tomato, queen, broad, bag, dish, twist, to mention only a few. Each indicates a different variety or a subtle distinction in the ranking scale.

— From *The Silent Language*, pp 101-103, by Edward T. Hall, Fawcett World Library, 67 West 44th St., New York, N. Y., 1961, 192 pp.

Solution to Proof Goof 6811:

Verse 4, line 1: Replace "lamps" with "lambs".

HANDLING SMALL AREA DATA WITH COMPUTERS

*Richard S. Hanel
Vice President and Manager
Urban Statistical Div.
R. L. Polk & Co.
551 5th Ave.
New York, N.Y. 10009*

"It's no trick at all for the computer to generate a million or so statistics for one block in a medium-sized city. The big job is to figure out what to do with a million numbers — how to work with them and what to conclude from them."

This article deals with today's capabilities for handling small area data with computers.

We will be dealing with three main points. First, a summary of eight important computer capabilities which are ready to be put to work right now. Second, some examples of practical, results-producing applications of those capabilities. And third, a few words of caution.

Our emphasis is on what can be done right now — *today* — in terms of what we consider to be an exciting new dimension in statistics — the dimension of space — which includes physical location and geographic relationship.

Credentials

First, though, just a few words to position the Polk Company and give our credentials for discussing computers and small area data. Our company is the "official scorekeeper" for the automotive industry. Each year, we process nearly 100 million car and truck registrations, in order to give the auto companies the detailed small-area statistics they need to keep track of all the cars and trucks which are sold and are on the road. Our experience in using computers to code and summarize vehicle registrations by small-area — such as census tract and dealer trading zones — goes back to the early 1960's.

Another important part of our business is the publication of City Directories. Each year, Polk interviewers go door-to-door in some 7,000 communities across the United States to gather the information which is printed in our City Directories. All told, we knock on the doors of some 24 million households and 3½ million businesses each and every year, as we take our annual City Directory Census of well over half the urban population of the U. S.

In the very early stages of programming our computers to sort and print the Directory information, we found that it would also be possible to turn the interviews into statistics.

So it is that for the last 5 years or so, we have been deep in the business of preparing address coding guides, coding and summarizing data for areas as small as a block, and designing the kinds of computer output with which the numbers could best be put to work.

20,000 Miles of Computer Tape

Company-wide, we're using close to \$10 million worth of third-generation computers — and some 20,000 miles of computer tape — to store and process just the current information in our files. And wherever you look in the Company, an important part of our computer activity is devoted to sorting and summarizing data by some kind of small area — be it street, block, tract, planning area or zip zone.

Now then, what have we learned in the last 5 years that might be of interest and use? In general, three things:

- First, there exists right today, plenty of computer capability for dealing very effectively and at very low cost with small-area data. We have all the equipment we need right now to plow the small-area fields thoroughly and efficiently.
- Our second main observation is that the people who are starting to put small-area capability to work, in even the simplest and most straightforward ways, are discovering that the computer is adding a whole new dimension to the meaning and use of statistics — the tremendously important dimension which includes physical location, density and geographic relationship. We now have the ability to track statistical change through space just as effectively as we've learned to track change through time.
- Third, we find that the computer is turning out to be a stern and demanding taskmaster which is setting a fast and tough pace for those who are pioneering in the use of small-area data. For example, it's no trick at all for the computer to generate a million or so block statistics for a medium-sized city. The big job is to figure out what to do with a million numbers, how to work with them and what to conclude from them, who's going to use them and how.

Based on a talk at the Federal Statistics Users Conference, New York, N.Y., September 12, 1968.

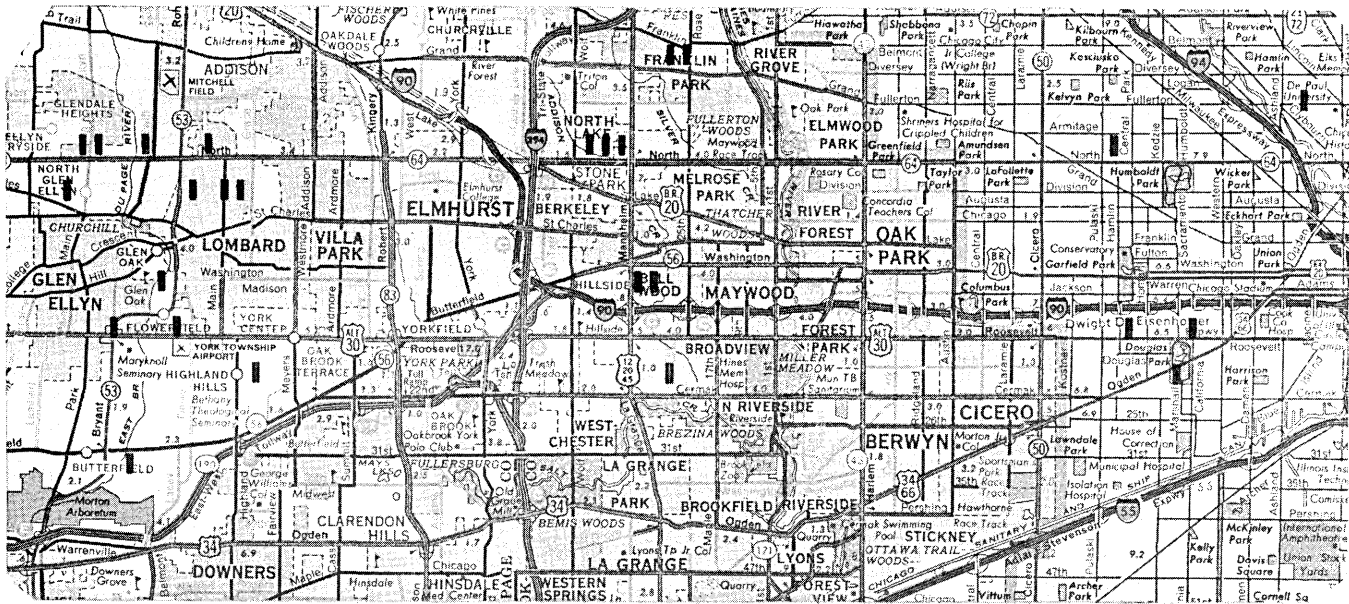

These are our three general conclusions. Now let's get specific — first, in terms of a look at some of the computer capabilities that exist right today for dealing with small-area data.

Computer Capabilities

Our starting point is the job of translating tens of thousands — or even millions — of street addresses into their equivalent small-area identifiers, such as block, tract, planning area or Zip Zone number. This job of *geo-coding* can be done by computer at the rate of 5,000 to 6,000 addresses a minute — roughly 100 per second — using a sorting table known as an address coding guide. The U.S. Census is preparing coding guides for many cities for use with the 1970 data. The main point here is that for many purposes there's no need to wait for the work that's being done for the '70 census — it's simple and inexpensive to set up your own customized, computerized coding guide which can go to work on your own data right away.

Once your records are geo-coded, the ability of the computer to store, select and summarize huge masses of data at blinding speed takes over. This capability for fast, low cost *mass-processing* is the foundation on which the whole small-area data business is starting to be developed. When you stop to think of it, it's only in the last few years, with computers, that we've learned to deal effectively with the reams of block data that have been available ever since the 1960 Census.

Flexibility

A third capability — and an outstanding characteristic of the computer information systems which are being developed and used these days — is the almost incredible *flexibility* with which computers can select and retrieve and manipulate the data in the files. A number of readily-available programs are making the design and production of statistical tables, summarizing data by small-area, a relatively uncomplicated and routine matter.

Another important capability of computers in dealing with small-area data is their tremendous power for developing valuable *by-products* as they perform their basic sorting and

counting operations. For example, as we summarize our automobile registration counts by small-area, we are simultaneously calculating and summarizing the probable number of miles those cars will travel in the next year, and how much gas they'll burn up in the process. In order to do this, the computer bounces each registration against a probability table which takes into account the make and age of the car, the number of cylinders, whether it's registered in the name of a male or female driver, and how many cars in total are registered at that particular household.

Another capability that we're learning to work with is the way the computer can use address or small-area designations — such as block or tract number — as a common denominator for *merging information* from any number of diverse sources, both internal and external.

An automobile insurance company, for example, can take an internal count of its policyholders by ZIP area and compare those figures with an external count of the number of car-owning households by ZIP. By calculating the percentage of policies to households for each of the 35,000 ZIP areas in the country, you have the beginnings of a very effective, small-area sales management and control tool. Incidentally, one of our computers is capable of performing the 35,000 percentage calculations in a little under 5 seconds. Printing out the 35,000 answers, including ZIP number and a six or eight digit percentage for each, takes a little longer — about 5 minutes.

With 35,000 numbers to deal with, we come now to another — and one of the most intriguing — new computer capabilities. At one stage of the game, we thought that well-designed statistical tables, itemizing small-area counts and subtotals, and complete with a wide variety of summaries, comparisons, percentages and ratios, would be just what the data users and decision-makers were waiting for.

As you might guess, it didn't turn out that way. For one thing, in most cases, there were — by definition — just too many numbers. 35,000 percentages, for example, are a bit much for easy review and decision-making. And more importantly, it's difficult for a statistical table to do any kind of justice to the discovery and display of geographic relationships in the data.

Graphics

We're beginning to find some answers to this kind of problem in the technique of *computer graphics*, which represents one of the most important new computer capabilities in dealing with large volumes of small-area data.

Quite possibly you have seen examples of maps which have been printed on computers. At one end of the line are the relatively simple profile maps in which specific areas — such as blocks or tracts — are clearly outlined and shaded in with a regular computer printer to indicate various levels of value in the data. At the far end of the range are the very precise and elaborate line tracings which are done on complex and expensive special equipment involving rotating drums, photoelectric cells, highly sensitive film and all manner of weird and wonderful devices.

One of the most interesting and advanced techniques is one which summarizes geographic data by calculating and printing the equivalent of contour or isotherm lines, and has the further ability to rotate the contours and look at them in three dimensions from the top or the side, or any angle in between.

It used to be that maps found their greatest use as the end product or display piece with which decisions already arrived at were justified or explained. After all, it used to take hours or even days to prepare outlines, locate and plot data, stick in colored pins and fill in the shadings for a map dealing with a hundred or so small areas. The computer has changed all that. Now it's a matter of less than one minute on the printer to turn out a map, 30 by 40 inches in size, complete with the data and shadings for 100 different areas. This kind of capability means that maps have moved out of the category of window-dressing and into the position of every-day working tools for spotting and interpreting the geography in the statistics.

In the urban statistical packages which we have designed for use by city planners and administrators, we routinely produce 100 or so different maps displaying selected tract-level data on population, housing, labor force, business activity and land use. And if anybody should want another 100 maps to be produced from other data in the file, it's only a matter of a few instructions to the computer.

A Shorthand Technique

Another kind of computer graphics is proving to be very useful in working with data for very small areas such as blocks. Here, we've developed a sort of shorthand technique whereby the computer prints an index number or a symbol at the position which corresponds to the geographic center of each of the blocks on a map. When you overlay this print-out with a transparency which shows the outlines of blocks, tracts or planning areas, you have a very effective way of looking at the geography of block data. It's also very fast — a standard high-speed printer can rattle off such a map, completely plotted with the data for 2,500 blocks, in a matter of 5 or 6 seconds.

This Model-T form of grid coordinate plotting is also an excellent device for spotting concentrations or exceptions in the data. All you do is select and print just those blocks which have values over a certain level. We used this approach in dealing with a good deal of our data for the 655-block West Side Detroit area which was struck by last summer's riots. In all, we printed over 100 maps showing concentrations of such items as total population by block, the number of housing units, the number of new movers, the number of female-headed households with children, etc. When we read the block printouts through overlays indicating those blocks where the greatest riot activity had taken place, it became pretty easy to spot some important relationships between data and damage.

Another new way to use computers for dealing with the geographic relationships in small area data is beginning to emerge. Somebody said to us not long ago: "Why don't you put all your maps on transparencies so that you could pile them on top of each other and get a cross-section look at what's going on?"

We thought about that one and reasoned that no matter how thin you printed them, you could only pile the maps so high. Then it occurred to us that the same computer programs that sorted out the tracts in order to set up the shadings on the maps could just as well assign a rating or rank number to each tract. Then if you had a rank number for each tract for a whole series of factors — such as the percentage of female headed household with children — you could add them up and get a composite rating by tract which would be the equivalent of trying to see through a bunch of transparencies.

One of the beauties of this approach is its tremendous flexibility. Rankings can be assigned, combined, regrouped and weighted with very little effort, and the composite ratings can in turn be summarized and displayed on maps. This is a good example of the kind of multidimensional processing that typifies the new and growing use of the computer as a working, analytical tool.

"Mathematical Models"

The last in this particular list of small-area computer capabilities is the new and fast-growing field which includes prediction, simulation and that all-encompassing term, "mathematical models". Our first-hand knowledge and experience in this field are so limited that we're going to pass up this one except for a single comment: while computer capability makes many of these models possible, it doesn't necessarily make them good. There's even one school of thought which says that every model builder should be required to demonstrate the assumptions and prejudices in his handiwork on a scratchpad and a desk calculator before he's even allowed to get near a computer.

To sum up, then, our first general observation is that there exists right today plenty of computer capability to deal very effectively and very imaginatively with small-area data.

Comparing Data From Many Sources

Our second major point is that these capabilities are adding whole new dimensions to the *practical* use of statistical data. Some kind of geographic identifier — be it individual address, or the designation of an area with its block, tract, or ZIP zone number — is turning out to be the common denominator with which great masses of data from many sources — up to this point unmanageable and unmergeable — can now be related and compared and summarized in a most useful and practical fashion.

Here are a few quick examples of how the computer is taking data from several sources and putting it together in ways such that one plus one equals a lot more than two.

Example: The Car Business

Our first example is from the car business. In one computer file, we have an address-by-address listing of all the new cars that are purchased, month-by-month. In a second file, we have a listing of all car owners. And thirdly, in our City Directory tapes, we have a detailed demographic profile of all the families involved.

Step 1 is to relate car purchase by make with car ownership by make — for an area such as a dealer trading zone or

a census tract. The rule of thumb is that car purchase closely follows car ownership—the odds are very good that the owner of Make A will buy another Make A, at an almost predictable rate.

As soon as the computer starts calculating purchase rates as a percentage of ownership, it's on its way to smoking out the geographic areas where sales attention is due—the beginnings of broad-scale, small-area exception analysis. Incidentally, this kind of analysis led to the discovery that there are more car buyers in just the non-metropolitan areas of the state of Ohio than there are in 85 of the traditional top 100 car markets across the country.

Then when you add in the economic and the demographic profiles of the families in each area, you have a powerful new index of the kinds of people who are in or out of the car market, what they are or are not buying, and at what rate. Facts of this kind up to now have been available only through samples, which for reasons of both expense and administration are usually so thin as to be of limited value in small-area analysis.

And finally, if you want to go way behind all the numbers and get into such things as opinion and motivation, you have in these merged and multi-dimensional computer files a well-structured and broadly based statistical universe from which you can make very precise selections for your sample.

Example: A Shopping Center

Let's take another example of new dimensions for statistics in space. Suppose that you are investing in a shopping center and that decisions on alternate sites are being made. The critical, money-making questions go something like this: How much business will the supermarket do, and how big should it be; how much floor space should we plan for a shoe store, and what grade of merchandise should it carry; and is there enough potential business to support a jewelry store? The problem is too much space and you lose money; not enough space and you lose business.

Studies are available which relate family expenditures for hundreds of different products and services to family-type—number in the group, occupation of the head, whether they own or rent their home, whether or not they have children, etc. Step 1 is to put the computer to work assigning and aggregating dollar expenditures by product, by family and by small-area—even down to the block. Next, set up the configuration and the weighting factors for the trading zones which surround each of the possible sites, and use the computer to make the thousands—or maybe even millions of calculations—that are required to estimate potential dollar sales by product line.

Finally, boil the whole thing down into as few as possible decision-type numbers and you have the exciting new pattern of geographic analysis that's beginning to emerge in practice as a result of computer capability in dealing with small-area data.

Example: Housing

A final example, this time from the public sector, is the critical problem of housing. Routine step one is to take an inventory of existing housing in the area involved—how much, what kind, what condition and where. Routine step two is to take a count and prepare a profile of the people involved—type and size of family, economic condition, etc. Then, with step three, we get into that new element of geography and computer capability. How does the inventory of housing and people—by location—relate to the needs for housing, present and future—by type and by location?

Where are—and where will be—the smokestacks and the jobs versus where are the workers? What is—and what will

be—the journey to work, and the need for transportation facilities? How about schools, bussing, integration?

By putting together computers, small area data, and some proven, accepted analytical techniques and models, it's possible to come up with practical answers to questions like these—answers that would never have been possible just a few short years ago.

A Difficult Taskmaster

Our third and last point, you may remember, is that the computer is turning out to be a stern and difficult taskmaster for those who are pioneering in the use of small-area data.

One of the biggest jobs, we find, is defining the job. What are the questions that need to be answered with small-area data? What data are needed to get answers that are useful and not just interesting? What is the best way to process and summarize the information? Who is going to take on the job of doing the analysis and drawing the conclusions?

Over the last three or four years, we've seen some rather negative reactions to the availability of small-area data—ranging all the way from complete disinterest, to skepticism, to informed detachment. The kinds of facts we're talking about are something new, and to some potential users, they're disturbing—resulting almost literally in an attitude of "Let's not rock the boat by confusing ideas with the facts."

It's heartening to see that recently quite a different climate is developing. Without question, there's a rapidly growing awareness of the need and opportunity for the use of small-area data. Couple this with the computer and technical capability that already exists, and you have the makings of a quantum leap forward in our skills in dealing with urban data.

At the same time, we must remain aware that there are hazards in moving too fast, and especially in accepting computer output at face value simply because all the answers come out in neat columns, complete to 8 or 10 decimal points. As someone recently put it, "G-I-G-O used to stand for 'Garbage In—Garbage out,' but nowadays, it's starting to mean 'Garbage In—Gospel Out!'"

The Need for Vigilance

We must also be alert to the fact that the computer is an avid and voracious collector of information. It is an indiscriminate eclectic, that makes it very easy and tempting to add just one more item to the file on the chance that somebody, someday might want it. Unless there's another somebody who is continually vigilant in restricting the file to what's truly useful—not merely interesting—you run the very real risk that your data bank will turn into a prohibitively expensive and unwieldy data dump.

And finally, in this kind of climate there's a need for constant vigilance—amounting almost to suspicion—in reviewing and appraising the computer's output, particularly when it is performing forecasting or quasi-analytical operations. It's well to remind ourselves that the output's only as good as the raw data and the instructions that make up the input, and that sometimes the question is not so much the computer's capabilities as the capabilities of the people who are telling it what to do.

Somewhere near center, there's the good solid position of careful appraisal mixed with well-founded optimism in applying today's computer capabilities to today's data requirements.

Without question, today's capabilities for handling small-area data with computers are adequate and are pointed in the right direction. Our skills and speed are picking up. And tomorrow's potentials for powerful, low-cost and innovative uses of the computer are becoming increasingly more varied, challenging, and exciting. ■

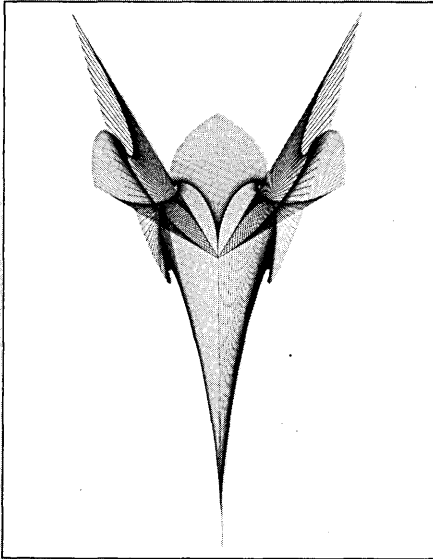

HUMMINGBIRD

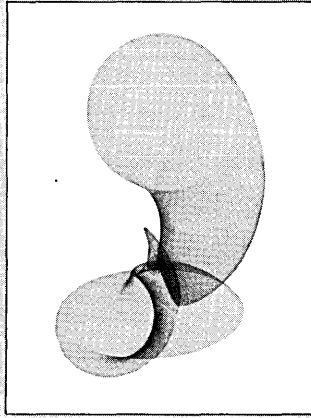

INSPIRATION

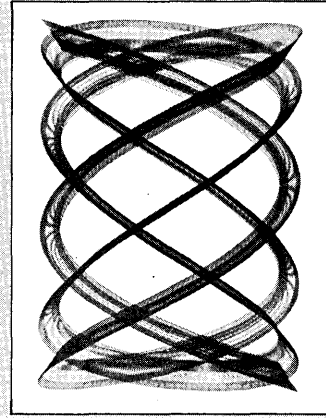

PLEXUS

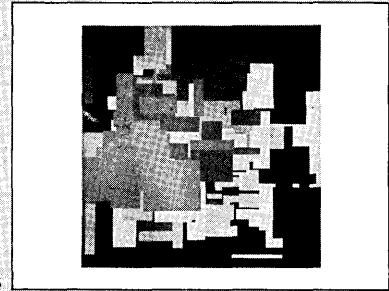

IDEALIZED BRUSH STROKES

SPECIAL OFFER!

full color reproductions of computer-generated artwork

Here is a unique opportunity to own a distinctive and unusual set of four prints from the 1968 Computer Art contest. Each print is 12" x 16" and is reproduced in magnificent full color on heavy weight quality paper suitable for framing. Symbolic of the computer industry, these attractive and interesting prints are ideal for decorating your office, den or home. Packaged in a handsome folio, they make distinctive gifts for friends or business associates. Each is imprinted on the back with a description of the programming technique, computer and plotting equipment employed to produce the art. Everybody in the computer field will want a set of these beautiful and impressive prints. Send for yours now. Supply is limited.

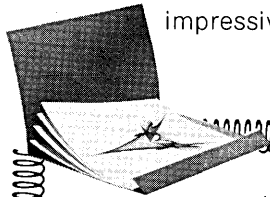

ORDER FORM

Gentlemen: please send your folio of computer art prints.
Enclosed is my check money order for \$10.00.

NAME _____

COMPANY _____

ADDRESS _____

CITY _____ STATE _____ ZIP _____

For orders of more than 10 sets, write for quantity price list

Compro

1060 KINGS HIGHWAY NORTH
CHERRY HILL, N.J. 08034
609-667-4709

AN INTER-CITY, MULTI-ACCESS, TIME-SHARING COMPUTER SYSTEM

"The expressed needs of all groups involved with computers proved to be remarkably similar. What they all wanted was computer service via remote terminals catering to either individuals, or, at most, to small groups of individuals, and computation in the full conversational mode."

*Grant N. Boyd, Manager
Computation Center, Dept. 8620
Northern Electric Co. Ltd.
P.O. Box 3511, Station C
Ottawa, Ontario, Canada*

To evaluate the information reported in this article, let us first describe the nature and purpose of the Northern Electric Company and in particular, its Research and Development activities.

The Northern Electric Company is the largest manufacturer of telecommunications equipment, wires, and cables in Canada. It employs well over 20,000 people at its eight major manufacturing plants, its 31 sales locations across the country and at its Research and Development Laboratories. The company's purpose is to supply the telephone industry domestically and also increasingly in recent years in the international field as well. In Canada our major customer is the Bell Telephone Company, but we also supply the independent telephone companies in the various provinces.

Until about ten years ago we had no Research and Development division. We simply produced Bell Telephone Laboratories' designed equipment under a licensing agreement with Western Electric. The decision of the company about a decade ago to have its own R & D opened large new areas of activity.

In our central laboratories there are some 800 employees involved in a wide variety of projects in the telecommunications field. Some of the areas of interest are shown in Figure 1.

Work in all these areas but particularly in the field of electronic switching requires massive amounts of commercial computer time and facilities far more powerful and sophisticated than anything required before.

Some idea of dynamic rate of growth of the R & D Labs can be gained from Figure 2. From its beginning some 10 years ago the work force has grown drastically, as can be seen. In addition to the growth at the Central Laboratories here, Branch Labs have sprung up at most of our manufacturing locations starting in 1965. Here again we have several hundred people engaged in intense scientific activity.

Computerization Begins

What of computer service for all these people? Let us go back to the beginning. The earliest computer users of any consequence in the Labs were the Filter Design Section of the Transmission Systems Group. To look after their computational needs as well as those of others in the Labs, an IBM 1620 Model I was installed in 1961. It was a card and paper

AREAS OF INTEREST

1. SOLID STATE
2. TRANSMISSION
3. COMPONENTS
4. GOVERNMENT PROJECTS
5. PHYSICAL SCIENCES RESEARCH
6. SWITCHING
7. STATION APPARATUS
8. WIRE AND CABLE
9. OUTSIDE PLANT AND MECHANICAL SYSTEMS
10. SYSTEMS ENGINEERING
11. LABORATORY SERVICES

Figure 1.

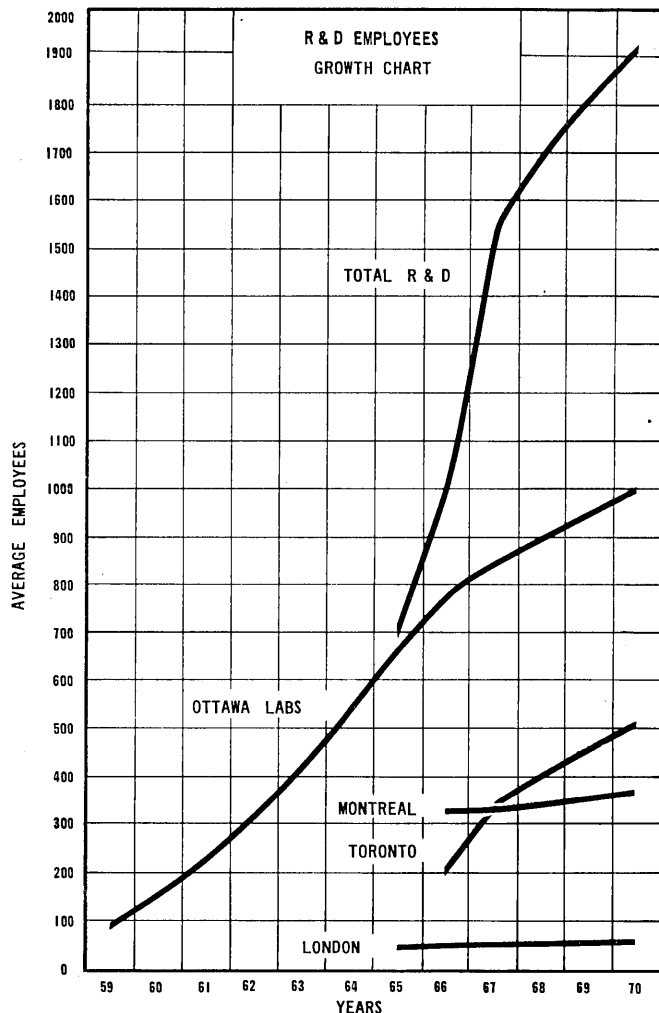

Figure 2.

tape oriented system run on an open shop basis. Neophytes were assisted in the use of the machine by some of the more knowledgeable personnel in Filter Design.

By 1964 it became necessary to replace the 1620 Model I with a disk-oriented Model II. The Model II had twice the speed of its predecessor and the disks and its own printer further added to the installation capability.

By 1964 the volume of computation had increased to the point where hands-on use of the machine was becoming impossible. The Computation Center was created, staffed originally by five people. Over the counter batch processing was the order of the day.

During 1965 the Computation Center was hit by explosively increased demands on several fronts simultaneously. The software group of the SP-1 Electronic Switching System was beginning to build up rapidly. With this build-up came the corresponding build-up of the volume and complexity of the load they imposed on the Computation Center. In mid-year a group of scientific staff who had been studying and learning the software of the #1 Electronic Switching System at the Bell Telephone Laboratories returned to our own Labs and almost immediately began to impose a computational load. Simultaneous with this, a group of Systems Applications Engineers who had been studying and learning another aspect of the #1 ESS software at Bell Labs returned to Montreal. It was soon evident that their computational needs could not be met by any of the Northern Electric computer facilities available or planned in Montreal. Finally as we have seen, towards the end of 1965 Branch Labs were established at locations in Toronto, Montreal, London, and Belleville. Some form of

computer service for these groups was almost immediately required as well.

Remote Terminals Needed

The expressed needs of all groups involved in electronic switching whether SP-1 or #1 ESS and even including the Systems Applications Engineers in Montreal proved to be remarkably similar. What they all wanted was computer service via remote terminals catering to either individuals or at most, small groups of individuals, and computation in the full conversational mode. With tight software schedules and very limited numbers of qualified programmers, it was imperative for these groups to achieve the maximum daily throughput per programmer. Conservatively estimated, terminal service with the conversational mode increases throughput over conventional batch mode by a factor of two. If terminal service is to be provided for some users, it may as well be provided to all users who need it; and of course, the Branch Labs fall into this category perfectly. The alternative to a powerful central computer servicing the Branch Labs via remote terminals is a collection of small low power machines one at each location possibly shared with non R & D users.

The Computation Center was constrained budgetwise to consideration of medium-scale systems as replacement for the 1620. After a thorough investigation of all systems within the budget range, it appeared that the Control Data 3200 came closest to fulfilling the requirements. The main reason it did was the availability of an experimental version of the MATS (Multiple Access Time Sharing) package. Also there was the ability to readily modify the Control Data FORTRAN to provide extended precision (now known as FORTEX). Extended precision was already in extensive use on the 1620 and was therefore, considered a must.

In February 1966 a Control Data 3200 was installed in the R & D central laboratories in Ottawa. Initially the 3200 was equipped with five IBM disks and three tape drives. We were limited to 32K of memory by hardware restrictions. On this system we ran alternate sessions of MATS and batch. The operating system was DISK SCOPE which was basically a simulation permitting us to use TAP SCOPE with disks. When MATS was on the air, limited file management but no execution was possible. Execution took place in a linear batch mode in the session following the MATS run.

In April 1966 the 3200 was replaced with a 3300. With this machine there was memory protection and the capability of extending core memory up to 256K words. Type 852 disks were added in June 1966 to the 1311's already in use.

File Space Requirements

In October 1966, faced with a rapidly increasing load, a second CDC3300 was added. About this time too all disks were replaced with the newer faster 854's, the capacity of whose packs was approximately 8 million characters vs. roughly 2 million for the 852's. With six disk drives per system we were up to roughly 100 million characters of disk capacity. We were finding that remote terminal users' requirements for file space were enormous. The requirements for tape drives also had increased and at this point we were up to ten 604 drives. Tape was the main means of communications between the systems which accounted in part for the large number of tape drives.

Also in late 1966 we converted to MSOS (Mass Storage Operating System). It proved to be quite a satisfactory system but did not provide multiprogramming.

The version of MATS in use under MSOS provided: —

1. Limited file management
2. Ability to request linear batch
3. Spooled output to remote terminal printers.

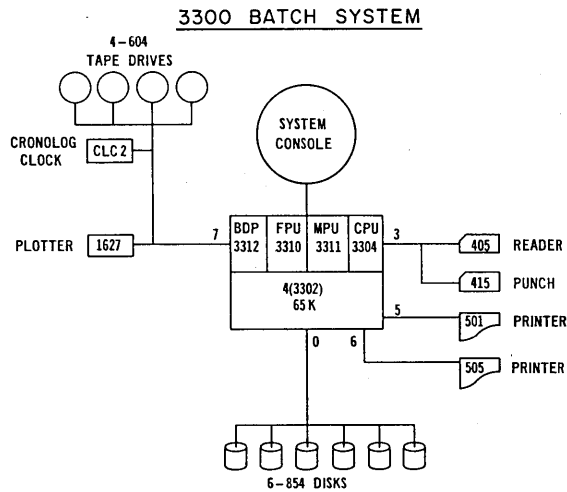

Figure 3.

An explanation of what we mean by "spooled output" might be in order. Up to an hour or so before closing time the output from the batch machine destined for remote locations was put on tape. This was then spooled back to the printers of the 8130's in the designated remote areas. Anything output later than this was run on the Computation Center printers and physically shipped via Bankers Dispatch to the desired location.

About October 1967 the MASTER Operating System Version 1.1 was introduced onto the batch machine. This is a true multiprogramming system, and with it an increase in throughput of some 40% resulted. In times of moderate load, turnaround times of 5-10 minutes were not uncommon. However, to gain the advantage of the multiprogramming capability at least 64K of core is necessary, particularly since jobs, once in core, stay there until conclusion.

MATS/MASTER

In December 1967 we converted to MATS/MASTER on our I/O system. The big advantage of MATS under MASTER is that it provides the capability of batch execution multiprogrammed concurrent with the MATS requests being processed. With this operating system we have been able to process well in excess of 200 two minute batch executions per day.

The version of MATS under MASTER 1.1 provides: —

1. Good file management
2. Queued batch — run on both machines concurrent with MATS
3. Ability to output to file
4. Direct and directable output from file (not via spooling) on: —
 - a) TWX terminals
 - b) TTY terminals
 - c) 8130 terminal printers
 - d) Computation Center printers.

It should be emphasized that extensive modifications to both MATS and MASTER had to be made by the Northern Electric Systems Group at R & D in order to bring these systems up to the degree of capability described. Indeed the present MATS is rather completely a Northern Electric product. However, MATS/MASTER is by no means a Northern Electric exclusive usagewise. It is also used at Oregon State University and at Sir George Williams University.

In March 1968 MASTER 2.0 was introduced onto the batch machine. This system provides task suspension with the

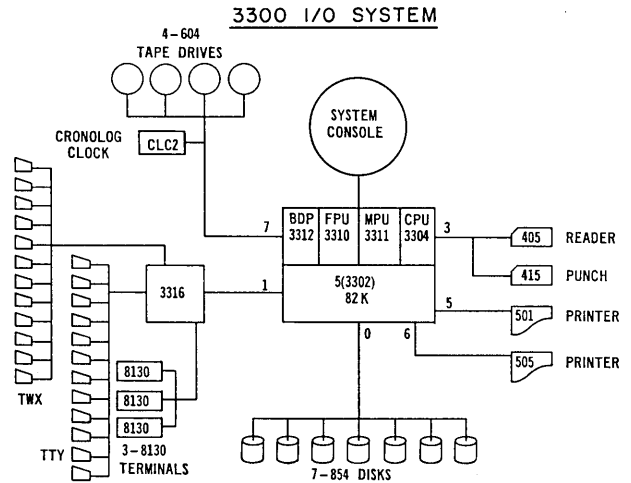

Figure 4.

roll-in, roll-out needed to achieve it. It also permits and provides for oversubscription of core with the result that core is used much more efficiently.

Current Configuration

The present system configuration is shown in Figures 3 and 4. In Figure 3 we have the batch system. In the central laboratories here we have some 200 users, many of whom use this system. In Figure 4 we have the I/O system. This system serves the needs of some 125 users in remote locations, although some of their work is also handled on the batch system. Also, a fair percentage of the workload of the central laboratories is processed on this system. The terminal equipment shown portrays reasonably accurately the number of devices in use currently. We will add additional equipment as required. We do not yet know the point at which observable degradation of terminal response time will occur with the addition of further terminal equipment.

Hardware

Recently we have been considering the advisability of replacing both our 3300's with a single 3500, configured as shown in Figure 5. Bench mark programs tested by us have confirmed that the 3500 is completely compatible with the 3300. Thus, such a change would not involve us in the usual

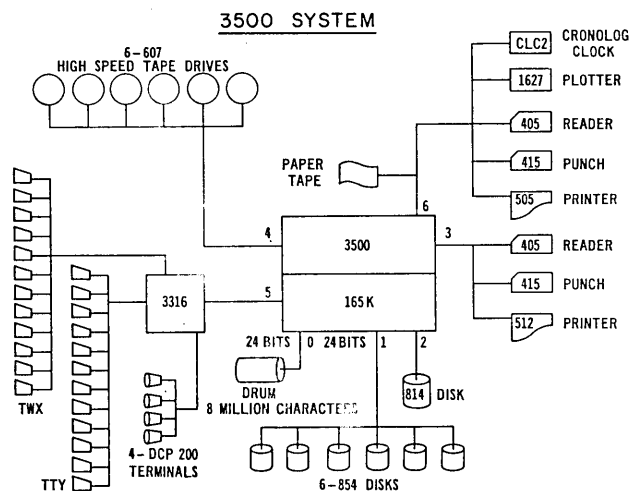

Figure 5.

painful conversion problems. These same bench mark programs have also confirmed that the 3500 is 2.3 times faster in throughput than a single 3300. This factor may be increased still further when 350 nanosecond memory becomes available as replacement for the 900 nanosecond memory with which the 3500 will originally be offered. The 160K of core memory shown is approximately what we have now. However, there are obvious advantages to consolidating all the memory in one system. Instead of wasting core with an operating system of approximately 30K resident in each machine, only one operating system is necessary, leaving approximately 130K of contiguous core with which to take advantage of the system's multiprogramming capabilities.

Since the 3500 is a third generation machine employing integrated and hybrid circuits, we have every expectation that the reliability of the 3500 will be substantially superior to that of the 3300. There is clear evidence that considerable attention has been paid both to reliability and also to rapid recovery from failures in the design of the 3500. It is only because this kind of concern for reliability is evident that we have even considered the possibility of replacing a dual system with a single one. In a remote terminal time sharing environment, unbroken system-up-time is of paramount importance.

Enhanced capability in the peripheral devices is also evident from the configuration diagram. The 8 million character drum enables programs and data to be rolled into and out of core as rapidly as possible. Permanently resident on a part of this drum would be our major compilers, PL/1, FORTRAN, COBOL, etc., plus certain important and frequently used tables. The tape units shown have twice the speed of our present drives, and another dramatic increase in disk capacity is also evident. In this latter regard it may be preferable for

considerations of reliability to have two 813 disk units rather than the single 814 shown. In any event the capacity of either arrangement would be between 200 and 250 million characters, which is an indication of the prodigious disk file space requirements of remote terminal users. The six 854 disk drives shown, representing a further 50 million characters, would be used for scratch purposes.

Terminals

In the area of terminals, we are considering a move from the present 8130's to such new hardware as the CDC type DCP200, or one of the many other similar-size terminals offered. The DCP200 is less expensive than the 8130, can be equipped with enhanced card reader and printer, and incorporates a CRT display. The twelve TTY's and twelve TWX's shown do not necessarily represent the ultimate number of these devices with which such a system could be equipped. Here again the upper bounds would have to be determined by the onset of appreciable terminal response degradation as extra terminals were added.

On the software side we hope to have implemented, by year end, full time slicing, which we are incorporating into MASTER 2.0. This will provide us with completely interactive programming, which has been one of our major goals from the outset. Interactive compilation, if implemented at all, will require at least an additional year following the implementation of time slicing.

About mid-year we expect to have operational our PL/1 compiler which will replace our present PL/1 translator.

Plans for the future in both hardware and software are being actively considered. However, these are necessarily much more nebulous than those already outlined. ■

Oxide dust is more costly than gold dust... but who wants it?

Loose oxide shortens the life of magnetic tape heads. It degrades tape. And it breeds still more dust as it is ground into fast-running tape. MS-200 Magnetic Tape Head Cleaner sprays oxide dust away. MS-200 is recommended by leading tape head manufacturers, prescribed by a major broadcasting network, used at hundreds of data processing installations. So, don't lose your head; use MS-200 Magnetic Tape Head Cleaner.

Price: \$2.75/can in cartons of 12 16-oz. cans.

Trial order: 4 cans @ \$3.60/can.

Prices f. o. b. Los Angeles, Chicago or Danbury, Conn.

 **miller-stephenson
chemical co., inc.**
Route 7, Danbury, Conn. 06813



U. S. and foreign patents pending.

AUTOMATED RETRIEVAL OF LEGAL INFORMATION: STATE OF THE ART

Stephen E. Furth, Mgr.
Information Systems Marketing
IBM Corp.
Data Processing Div.
112 E. Post Rd.
White Plains, N.Y. 10601

"Far from 'making humans obsolete', computerized search techniques enable legislators and legal staffs to concentrate on the why, the what, and the interrelationships of laws, rather than on tedious and time-consuming efforts just to find the law."

In 1964 when Robert F. Kennedy entered the lists as a candidate for U. S. Senator, a New York State legislator decided to find out if there were any residence requirements imposed by state law on candidates. While he was about it, he thought he would also look into residence requirements for hundreds of other office holders in the state, from village police chiefs to Governor.

He found out — not by delegating the statutory search job to a battery of specialized researchers who might have spent many tedious hours with indexes and law volumes — but by putting his request to an electronic computer.

Stored verbatim by the state's computer system were all of the New York statutes — nearly eight million words of them — plus a comprehensive dictionary of key words from which could be chosen those particular words most likely to unlock sections of the law pertinent to the request. In short order, the candidate had his answers.

The computer, speedily and accurately, spewed out a large number of exact references to residence requirements for many of the offices. But, for a U. S. Senator, there were no requirements.

The computer's high-speed printer could do more than merely cite laws relevant to the other offices; it could print, in full, those sections of the law containing the references.

This event, more than four years ago, took place in the fairly early days of computerized search. Now, such tasks are routine in many states. Already at that time, however, such methods had been effectively proved out in the service of the federal government and a number of states, including New York. Over a period of years, much basic development work had been done in the general area of documentary information retrieval by computer. The University of Pittsburgh's Health Law Center, under the direction of a lawyer, Professor John F. Harty, had pioneered since 1960 in developing, applying and refining systems specifically in the field of statutory search by computers. The Center did so initially to meet its own research needs regarding health laws in all states; then it went on, under contract with states, to start other systems by committing whole bodies of state, city and federal law to magnetic tape. This work is now being continued by Aspen Systems Corporation headed by Harty.

Wide Use For Legal Search Systems

Nowadays, computerized legal search systems are in use serving the states of New York, New Jersey, Pennsylvania,

Ohio, Iowa, Kansas, Hawaii, Massachusetts, West Virginia and Texas, and cities such as Pittsburgh. In addition, the U. S. Air Force operates the LITE (Legal Information Through Electronics) system serving the Department of Defense (DOD) and other federal agencies wishing to use the service. The LITE system, which was developed under contract with the U. S. Air Force Finance Center by the University of Pittsburgh and IBM, now incorporates the entire U. S. Code as well as other voluminous bodies of information. These include DOD fiscal and accounting regulations of various kinds, administrative decisions of the Comptroller General affecting DOD, appropriation acts of Congress — even a body of selected international agreements affecting DOD areas of responsibility.

Essentially the same computerized information retrieval techniques can be, and are being, applied to the storage and search of textual information of almost every description: judicial decisions; ordinances; departmental codes and regulations; administrative decisions; results of agency adjudications; review decisions of courts martial; bodies of official memoranda; as well as technical, scientific and medical literature, and texts of patents.

Equipment and Programs

Developments in the information storage and retrieval field have moved at a rapid pace in this decade. Larger and more quickly accessed data storage devices are available, capable of storing millions of words. Computers, themselves, now have greatly increased speeds as well as expanded capabilities. Some of these are multi-programming systems capable of working on a number of jobs at the same time and serving users even at remote locations. Input devices and techniques have been considerably refined, so that text can be entered into the computer by keyboard in the form of English statements. Output devices for providing computer responses now include desk-top video display units and typewriter terminals which can operate "conversationally" and on-line to a computer by common carrier communication lines.

In step with these advances in computer "hardware", as applied to textual information storage and retrieval, an advanced, easy-to-use program package called the System/360 Document Processing System has been introduced.

Used with appropriate computer models of various capacities and configurations, it is well suited to the varied needs of legislatures, and governmental agencies, and it could be used

by a central organization to serve individual members of the legal profession. The Document Processing System incorporates many refinements and flexible features which not only take advantage of the direct access retrieval capabilities of today's computers but represent the accumulated experience of the past in the whole field of automated storage and retrieval of text.

Computer Role Assessed

The results of statutory search are not often as newsworthy as in the case of the New York legislator's quest for state laws governing residence of U. S. Senatorial candidates. But computers are playing a rapidly increasing role in the legislative and governmental process.

Far from "making humans obsolete", computerized search techniques enable legislators and legal staffs to concentrate on the *why*, the *what* and the *interrelationships* of laws, rather than on tedious and time-consuming efforts just to *find* the law.

The computer places one of the greatest research tools in history in the hands of legislatures from coast to coast," New York State Senator Earl W. Brydges stated in an article. "Because it can do its work quickly, surely and extensively . . . it saves interim committees, research counsel, and law revision agencies thousands of man hours that would otherwise be consumed simply in trying to find all laws on a specific topic, [and then typing] and reproducing them in quantity for scissoring, pasting and reshuffling.

One user of the LITE system, an attorney advisor with the Air Force Accounting and Finance Center, remarking on the psychological hurdle he faced in accepting computer search techniques, wrote in JAG, the Air Force legal review:

One cannot view the computer operation in an information retrieval center or watch the search printout without being more than a little skeptical that such an electronic monster can really be accurate at high speeds. I initially felt impelled to make an independent check and verification of accuracy . . . It did not take long to satisfy myself that the computer's operations were wholly reliable. Then came the realization that *human* error lies behind the vast majority of the mistakes and failures of computer interrogation . . . the researcher begins to concentrate his energies upon improvement of his mastery of the art [of framing questions for the computer].

Basic Principles and Techniques

Actually, users of the system need know little about the mechanics of computer operation. Users frame their inquiries in English, using the very words and terms likely to be found in particular laws or other bodies of information being searched. The principles on which the search system operates are, in reality, quite simple. In fact, it locates specified key words (words used in the search), wherever they appear in the body of law or other data being searched.

The technique of framing questions for the computer is not difficult to learn and is based solidly on the justifiable assumption that a computer is a rather "stupid" and "unimaginative" machine. That is, it cannot do the thinking for the user. It will give full and satisfying responses only to pointedly expressed questions—but it will do this at high speed with remarkable dependability.

For example, the Administrative Office of the U. S. Courts wanted to identify every section of the U. S. Code which defined felony. Study of the search formatting problem indicated that since the word "felony" did not consistently appear in laws defining felonies, the way to get at the data was

to base the computer search on punishments specified in the law for offenses of felony level; punishments are always specified.

If one were framing a search involving the word "condemn" or its variations, he would need to make plain with additional descriptive words whether he was interested in condemned men or condemned property and, if the latter, what kind or kinds of property.

Accuracy, Speed, and Dependability

As regards accuracy and dependability, during the testing period for LITE various human users from different government departments pitted their search capabilities against the machine by duplicate manual searches. The computer found all the citations requested in the law 92.5% of the time, and men using manual methods found all the citations only 51.6% of the time. It was even thought the computer's performance would have been better, if not perfect, had questions to it been better framed.

In another test pitting manual search jobs against computer search jobs, the problem was to locate all sections of a particular Title containing the word "dispose" or some variation. Two attorneys took two days to uncover 91 sections. The computer quickly produced 133 section references and pointed the way to discovering four errors in the manual search—errors which occurred when fatigued humans read the word "deposition" for "disposition."

As for speed comparisons, the director of the state of Iowa's Research Bureau cites a manual search project undertaken before adoption of computer methods which took four researchers ten days to study 2,988 pages of the code. That kind of job today is done by Iowa's computer in ten minutes.

General Applications

To agencies of government, automation of retrieval in this way can give speedy information regarding almost any body of data, including the statutes, set up on the computer. This helps agencies to conform to the law and to follow established precedents. It can even help them in studies of the law affecting their operations with a view to recommending changes.

In the drafting of bills, legislators and their staffs can much more easily achieve consistency in the use of statutory language, and can quickly determine what would be involved in changing terminology in other sections of the law. Or they can quickly find if a word or phrase is already used in other contexts in other statutes and has thus developed different meanings.

As an example: When new court rules were being prepared for enactment in Pennsylvania, a search was made for all statute sections dealing with each topic contained in the proposed new rules. Several instances were found in which actual or potential conflict existed between the law and the rules, and these conflicts were eliminated from the rules before promulgation by the state's Supreme Court.

In large recodification projects, too, the speed and versatility of the computer search system can greatly expedite the work, cutting the time to a small fraction of that required for manual searching. Texas currently is using automation in a complete recodification of its statutes. A complete recodification job has been done of the ordinances of the City of Pittsburgh with the aid of computerized search.

In recodification work it is possible, by computer, to locate speedily all statutory sections which deal with a particular substantive area, regardless of title or chapter in which they appear. Thus, a New York State legislator, interested in pull-

ing together all the laws affecting banks, learned that there were more than 1,600 of them not in the banking title which he never knew existed. In such law modernization projects, the computer can point out duplications and obsolete sections, draw together, reorganize and print out the particular related body of law in logical order as directed.

In Pennsylvania, a search was made for laws affecting Division of Welfare functions, and it proved possible to separate them into two categories — those stating the responsibilities of the Division, and those of interest to the Division for which other arms of state and local government were responsible.

Similarly, in revisions and amendments of law, work can be expedited by having the computer print out desired sections, then quickly and inexpensively duplicate them by offset, with proposed changes inserted, for distribution and examination. Single laws, or groups can be handled in this way.

Economic Considerations

One economic fact to be faced in the adoption of an automated search system, particularly for smaller states, cities and counties, is that the computer works so fast it is difficult to keep it fully occupied through legislative sessions. Where legislatures meet only once every two years, a computer dedicated to the one task would, like the legislators themselves, be working only every other year. For a very small part of the alternate year, only, could it be occupied with such tasks as updating the law in its memory or storage, or preparing tapes on new laws which could be used for automatic typesetting in the publishing process.

In some cases, the economic problem can be worked out by sharing a computer operated by another arm of government, such as the tax or general services department. In other cases, the solution might lie in contracting for computer services outside government,

In larger states, more intensive use of the computer can be achieved by expanding the scope of jobs assigned to it. In New York and Pennsylvania, for example, plans are to utilize a computer to provide a complete "status information" system. This system would keep track of bills from the time they are introduced, through the time spent in committee, to final passage or other disposition, including action by the Governor. Also, the computer can be loaded with other bodies of information (called "data bases" in computer circles) valuable either to legislators or to other branches of government. The computer, and the Document Processing System, have the capacities to accommodate multiple data bases as well as multiple clients.

Advanced Retrieval Program

The System/360 Document Processing System program package — several years in development — is expansive and flexible enough to accommodate large volumes of textual data and multiple bodies of data.

It features the extracting, indexing, and storing of key words from the text plus the storing of bibliographic data, such as title and section of law. It also causes the computer to do the indexing automatically from either full texts or abstracts as they are being entered in the computer. The need for manual indexing beforehand therefore could be eliminated completely. The system will produce its own index of stored material based on key words extracted from the text. It can also handle material that has been indexed manually.

As their primary output, the System/360 Document Processing routines provide bibliographies (citations) as well as (optionally, at user discretion) full text printouts.

The program package operates under the control of Operating System/360, a set of standard versions of operating

programs which automatically translate the comparatively simple user instructions into the more detailed and complex sets of instructions "understood" and acted upon by the computer.

For most users, a main computer processing unit with 128,000 positions of primary storage is sufficient to contain both the Operating System/360 and the Document Processing problem programs. Secondary storage requirements for the actual data — text, bibliographic data, key words and index data — can be provided in the form of large-capacity IBM 2311 Disk Storage units. Other peripheral and input/output equipment consists of standard units commonly used with System/360 computers in the medium-scale range.

System Organization

Briefly, the System/360 Document Processing System is organized in the following way.

There are five closely interrelated groups of data sets which can be called into play when textual material is being entered into the computer or searches of stored information are being conducted. There are separate data sets for each separate body of information (data base), such as all the statutes of a state, the internal code and regulations of a department of government, etc. The five data sets are:

1. The Master Set, which contains serial numbers for every document plus, optionally, the bibliographical identifying data and its encoded text in source-document order. In the case of statutes, each section is given a number.
2. The Dictionary Set, which contains one entry for each word appearing in a text which has been considered by the system user to be significant, worth "remembering" for search purposes; the score on repetitions of these words throughout the whole data base is continually and automatically updated as new documents enter the system so that current word-use-frequency indicators are generated for all words.
3. The Vocabulary Set, which automatically, from incoming documents, builds the location record for each word in the dictionary throughout the whole data base by storing behind each key word the document numbers in which it occurred.
4. The Synonym/Equivalent Set, consisting of words which have been selected by the system user to be employed in subsequent textual searches in addition to, or instead of, the Dictionary words in order to expand searches. This is an optional file.
5. The full Text Set, which the system user may elect to establish, or not, depending upon whether he considers it worthwhile to have complete texts stored by the computer for later printout; he may choose, for reasons of economy, to provide only printout of citations and to rely on manual search for full text retrieval.

Versatility and Flexibility

One of the principal goals of the Document Processing System is to make the search job as easy as possible for people with only a rudimentary knowledge of how a computer works. Many of the steps in this automated storage and retrieval scheme have, themselves, been automated to speed operations and to reduce as far as may be advisable the number of steps that require user decisions or human intervention during processing.

For example, lists of common words such as articles and prepositions, as designated specifically by those establishing the particular data base, can be automatically dropped out

Do it on a graphuter

An aircraft designer with an idea goes to a computer-controlled display scope and picks up a light pen. In a few moments he puts the sketch of a new wing structure on the scope face. (The lines aren't uneven, because the computer straightened and smoothed them.)

Now he issues a series of instructions to the computer: "Make the flaps 15% shorter. Widen them to replace the area just lost. Make the trailing edge slant back at a sharper angle. Show me a perspective view." He questions: "What is its length? Width? Wing-span?" And a final instruction: "Give me E-sized drawings of front, side, and top views, with dimensions and listing of sub-assemblies."

It took less than 10 minutes of the engineer's time to show what can be done when we learn to manipulate visual information directly. Difficult, yes. But inevitable.

Consider the evolution of information handling. We've done very well manipulating numbers, letters, and arithmetic — with the desk calculator, the teletype, and the computer. There remains a world of graphic information, larger by far than our systems of symbols, to be bent to men's use.

This is what Information International has been doing — making programmed electro-optical systems to interpret visual information and to act on it. We have delivered systems to analyze seismograms and oil well logs, read oscilloscope waveforms, examine biomedical samples (directly through the microscope), interpret oceanological films. Score multiple-choice forms, make charts and graphs from digital data. It's an interesting start. We're pushing the inevitable, you might say. Your inquiry might well hasten it.

Information International Inc.
545 Technology Square,
Cambridge, Mass. 02139
(617) 868-9810

11161 West Pico Boulevard,
Los Angeles, California 90064
(213) 478-2571

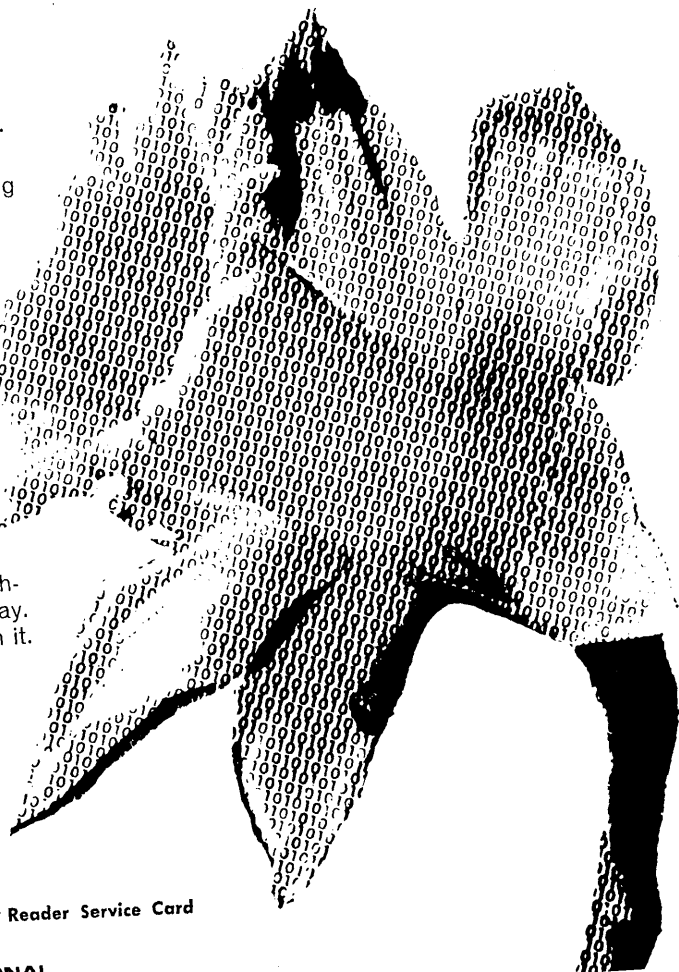

Designate No. 14 on Reader Service Card

INFORMATION INTERNATIONAL

ANNUAL PICTORIAL REPORT

Sharry Langdale
Associate Editor

This Annual Pictorial Report seeks to publish interesting and informative pictures of new developments in the computer field during 1968. We have tried this year to focus this report on pictures which illustrate how new equipment is made, how it operates, what it is made of, etc. We hope this report will be useful to our readers.

The appearance of many new companies in 1968, the spread of time sharing, the increasing use of small computers — in fact a substantial growth in nearly every

area of the computer field has created a large number of new products this year. Most of these new products have been reported, as they were announced, in the "Computing and Data Processing Newsletter" section of Computers and Automation each month.

Accordingly, the Annual Pictorial Report for 1968 has a somewhat different central purpose from those of prior years.

DIGITAL COMPUTERS



PDP-8/L COMPUTER / Digital Equipment Corp., Maynard, Mass. — Evolution of the small computer is seen in this comparison of DEC's first computer, the PDP-1, with the company's new PDP-8/L, foreground. The PDP-8/L is about the size of the electric typewriter used as an input/output device for the PDP-1, introduced about 10 years ago (and still in service). The PDP-8/L is a full scale, general purpose, 12-bit machine with over 4,000 words of core memory and a 1.6-microsecond cycle time. Core memory is expandable to 8,192 words. (Circle #46 on the Reader Service Card.)

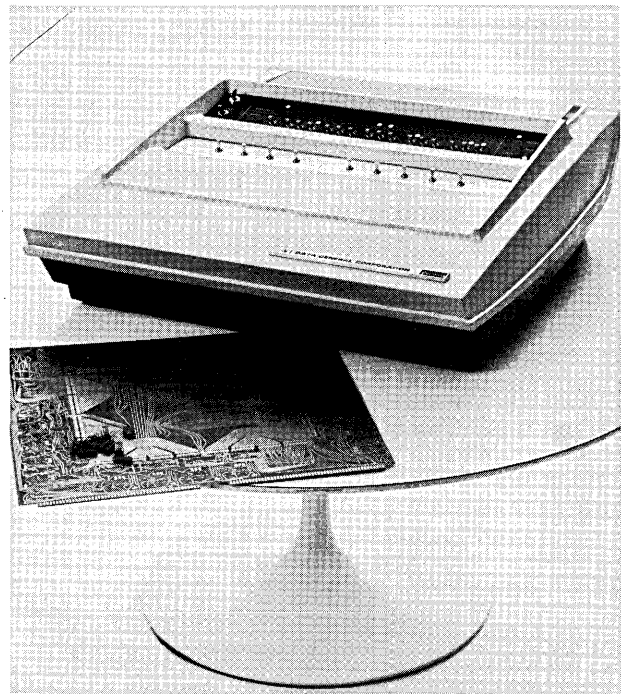

NOVA / Data General Corp., Hudson, Mass. — The NOVA is a general purpose computer designed around medium scale integration, and organized around the multi-accumulator architecture found in such large scale third generation computers as the IBM 360 Series. A NOVA configuration can contain up to 16,376 16-bit words of core or read-only memory plus interfaces for up to eight input/output devices. A 5¼" standard rack mountable version of the NOVA will contain the same amount of memory and I/O interface as the desk top version shown above. Expanded versions of the NOVA can be configured to contain up to 32K 16-bit words (64K 8-bit bytes) and 64 input/output devices. (Circle #45 on the Reader Service Card.)

Digital Computers



NCR CENTURY SERIES COMPUTERS / The National Cash Register Co., Dayton, Ohio — The Century family of computers is based on such design advances as high-speed thin-film memories, disc memory innovation, and monolithic integrated circuitry as shown in the pictures below. Two magnetic discs are an integral part of every computer in the series. The "built-in" system disc is used as a reservoir for the storage of operating software, as well as providing inexpensive disc storage in place of the main memory for many computer functions. Each removable disc pack, made up of three discs, stores a total of more than four million bytes of information. All models in the Century Series have on line, real-time capabilities. (Circle #41 on the Reader Service Card.)

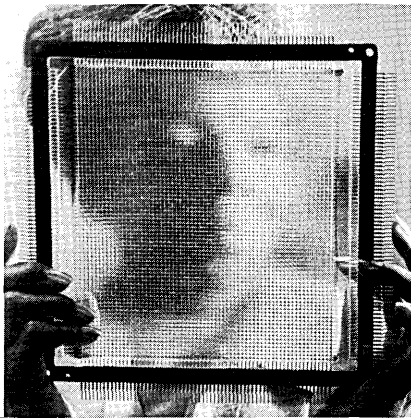

The memory plane of the computer (left) holds 4608 bits of information on tiny rods, only one-tenth of an inch long. These rods (right), coated with thin magnetic film, replace the doughnut-shaped ferrite cores used in most other computer memories. The rods are automatically placed in solenoids — coils of two interwoven wires — with an inner diameter of only 10 mils. After assembly, memory planes are coated with plastic and stacked to form memory modules. The memory operates at a speed of 800 nanoseconds (billionths of a second).

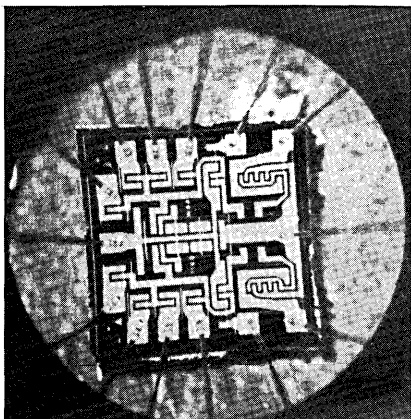
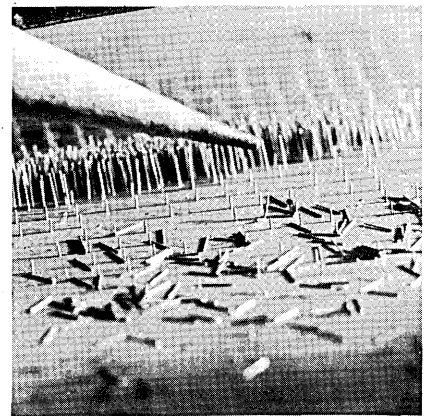

Monolithic integrated circuits (left) are used throughout the system, including peripheral units as well as the central processor. One standard monolithic integrated circuit (1/16" square) is used in all components. The single monolithic circuit is arrayed in varied combinations on different circuit boards (right). Only six different types of cards make up 80 percent of the logic circuitry.

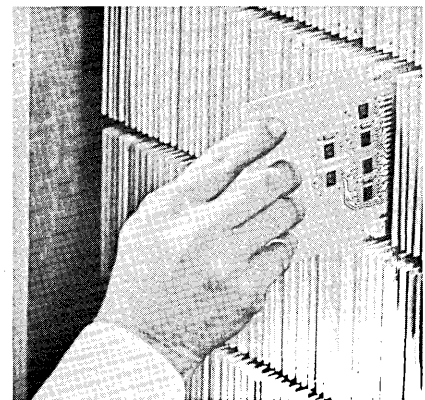

Digital Computers

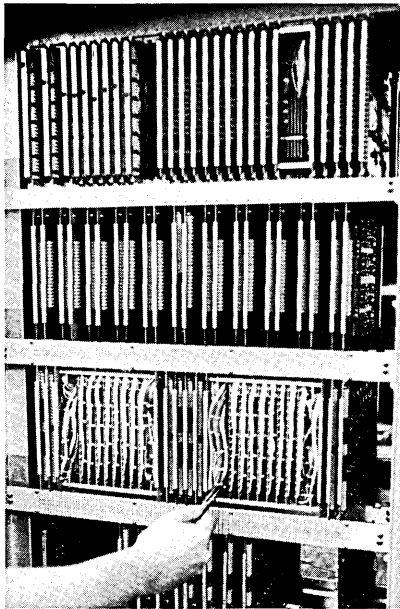

IC-4000 COMPUTER / Standard Computer Corp., Los Angeles, Calif. — The dual memory of the IC-4000 is shown at the left. The system (shown undergoing final tests in the picture at the left below) is problem adaptable and relatively independent of hard-wired machine languages. The central processing unit is a dual memory, multi-lingual, computer-within-a-computer which substitutes microcoding for the first link between functional stations. Examples of problem adaptability include: time-sharing, emulation of existing computers or prototypes, simulation, and micro-programming of fast compilers. (Circle #42 on the Reader Service Card.)



TIME-SHARE-8 SYSTEM / Digital Equipment Corp., Maynard, Mass. — DEC's TIME SHARE-8 system is shown at the right being readied for delivery. The system, built around the PDP-8/I, is a multi-language, general-purpose time sharing system that can handle from 8 to 32 users simultaneously depending on options and the number of terminals selected. (Circle #44 on the Reader Service Card.)



IRIS 50 / Compagnie Internationale pour L'Informatique, Louveciennes, France — In the IRIS series the functions of the central processor are executed by separate units, both free-standing and modular — a storage unit, a program control unit, and two (or more) input/output control units. Freestanding, these units operate in complete simultaneity. Modularly they provide ready adaptation to users' needs. The main core memory stores from 16,384 to 262,144 bytes, in four banks accessible independently and simultaneously; cycle time is 950 nanoseconds for a 2-byte word. The program control unit recognizes 102 types of instructions and executes them in an average time of 6.6 microseconds. Input/output control units allow an I/O rate of up to 1.5 million bytes per second through standard peripherals and communications devices. (Circle #43 on the Reader Service Card.)

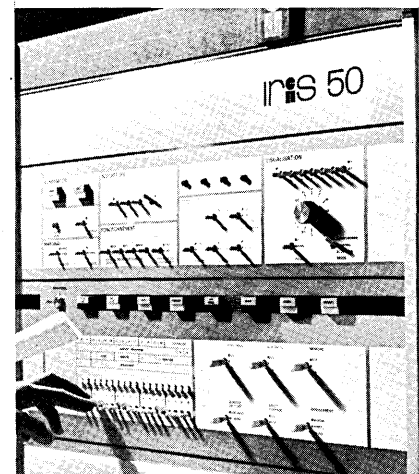
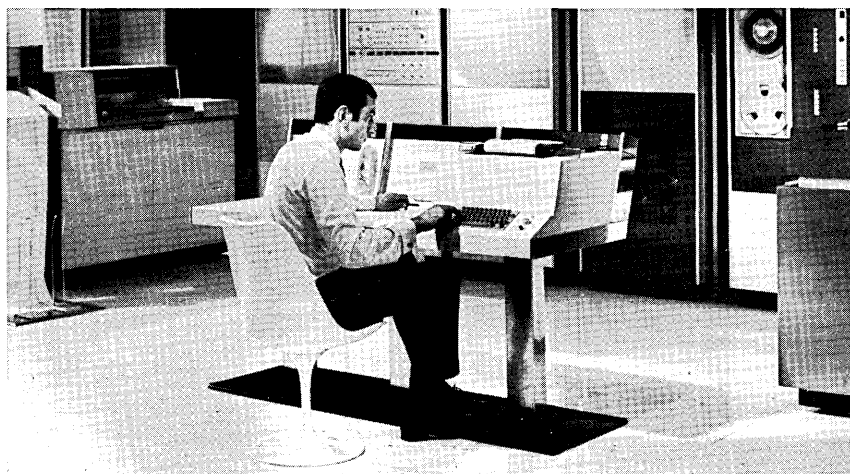

MDP-1000 DIGITAL COMPUTER / Motorola Instrumentation and Control Inc., Phoenix, Ariz. — The Motorola MDP-1000 small scale digital data processor has 4096, 8-bit words of memory capacity expandable to 16K capacity. The random access, single address memory has 2.16 microsec-onds cycle time. The new computer is offered for use as an integral system component of data communication terminals, for use in supervisory control, real-time accounting, and data logging systems, and as a preprocessor for large-scale computers. (Circle #47 on the Reader Service Card)

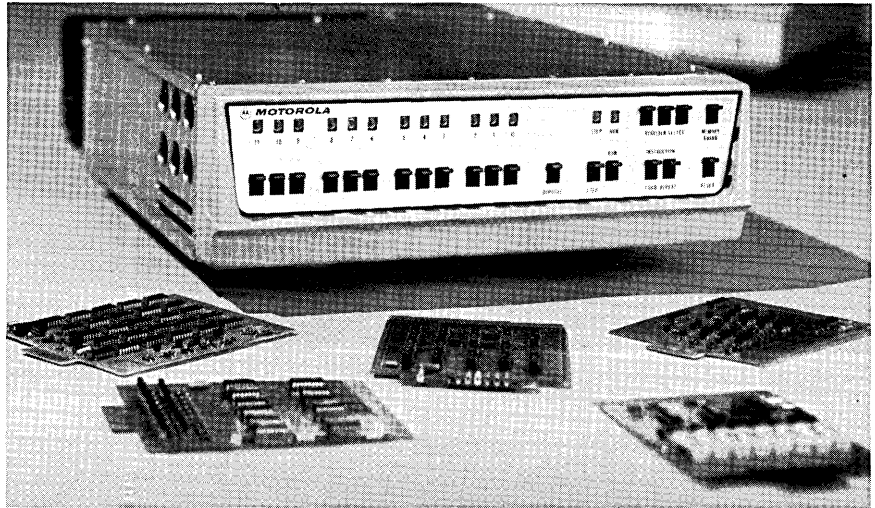

DC-6024 DIGITAL COMPUTER / Datacraft Corp., Ft. Lauderdale, Fla. — The basic DC-6024 processing unit includes five 24 bit general purpose registers, three of which may also be used as index registers; 8K-word memory; hardware multiply/divide/square root; and four true levels of priority interrupt. The basic I/O includes an ASR-33 Teletype. The DC-6024 is designed for use in simulator, process control and scientific applications including multiprogramming, time sharing, real-time and off-line uses. Standard software includes an assembler, utilities, support library including USA FORTRAN math functions, hardware test routines and a modular resident operating system. (Circle #48 on the Reader Service Card.)

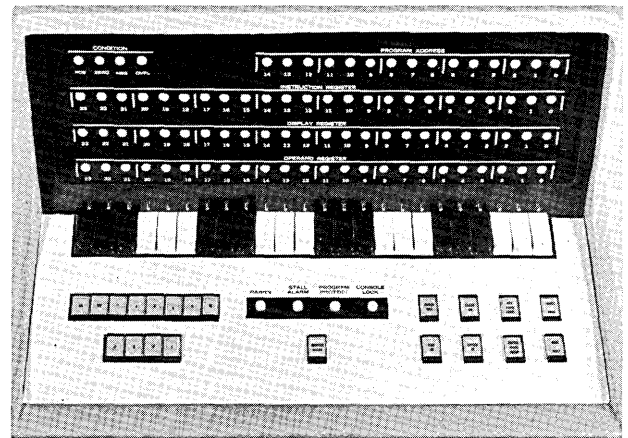

H632 COMPUTER / Honeywell Computer Control Div., Framingham, Mass. — Small to large computer complexes may be designed around the H632 system. The basic computer is made up of a central processor, input-output processor and 8,192 words of memory. At its maximum configuration, the H632 has four central processors, four input-output processors and 131,072 32-bit words of memory. Medical and scientific uses for Honeywell's H632 computer include patient monitoring, on-line scientific analysis and off-line computation. The integrated circuit computer is the first of a new line of Series 32 computers for scientific and control applications needing multiprocessor, multiprogrammed capabilities. (Circle #49 on the Reader Service Card.)

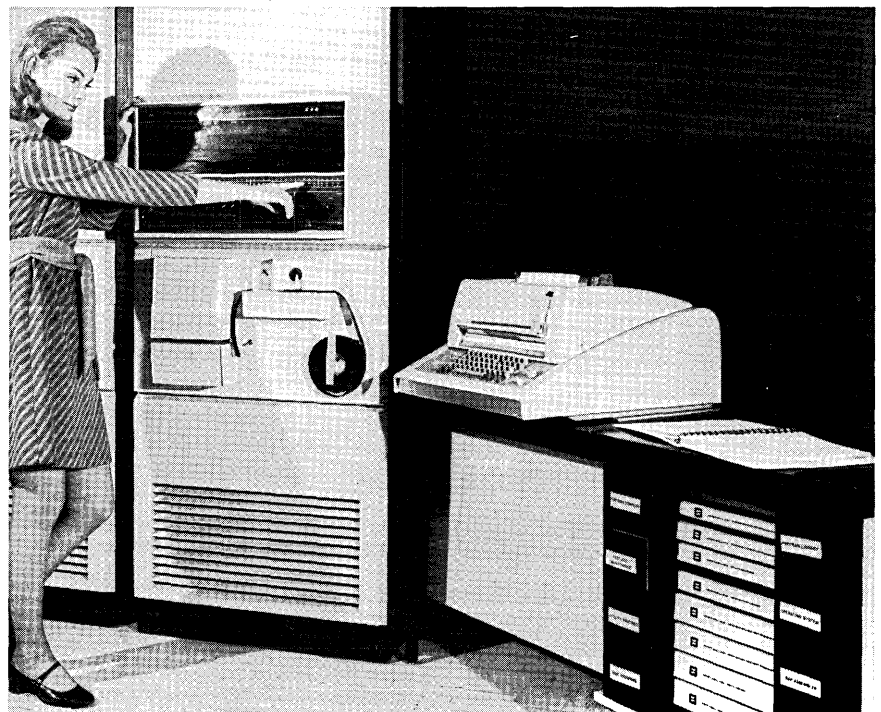

Digital Computers



P203 COMPUTERIZED ACCOUNTING MACHINE / Olivetti Underwood Corp., New York, N. Y. — The P203 (a console unit consisting of an electronic digital computer with printout, combined with an office electric typewriter) has millisecond speed, can be programmed, and prints alphabetic letters as well as numbers. The electric typewriter key-board permits the operator to type individual information on invoices, forms and reports, while the pre-programmed computer section of the machine computes and prints out all figures automatically. While preparing volume numbers of invoices ready for mailing, the machine simultaneously produces management records. Programs for the machine are stored on cards about the size of dollar bills. Two programs of 160 instructions each can be recorded on one card. The cards are written at the keyboard of the machine, and are inserted directly into the machine for computer operation (as shown in the picture). (Circle #65 on the Reader Service Card.)

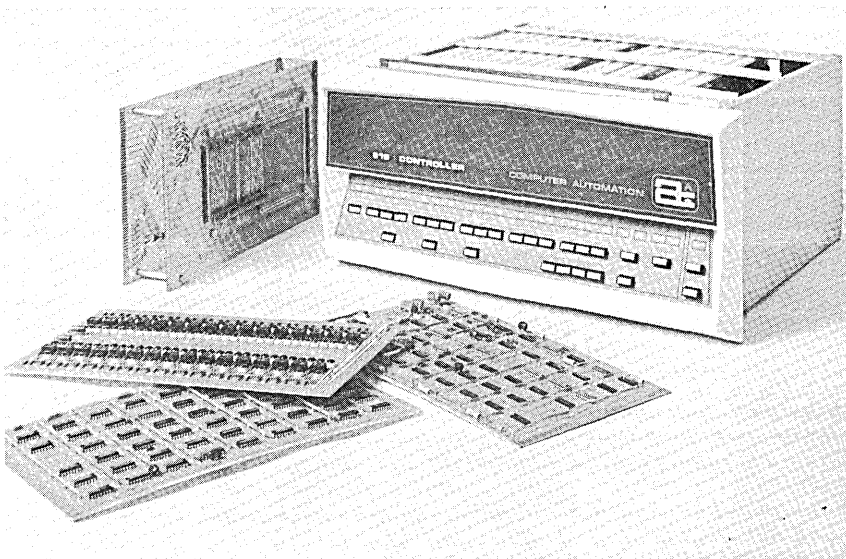

PDC 816 / Computer Automation, Inc., Newport Beach, Calif. — The "Programmed Digital Controller," Model 816, has a 4,096 word 16-bit memory, an 8-microsecond memory cycle time, and over 140 basic instructions. Model 816 includes multilevel indirect addressing, hardware index register, parallel processing, block input and output, and three priority interrupts in the basic controller. Many standard peripherals are available. Both the 816 and the PDC 808 (introduced earlier this year) are designed to perform a variety of control, monitoring, data logging, data communication and calculation tasks. (Circle #50 on the Reader Service Card.)

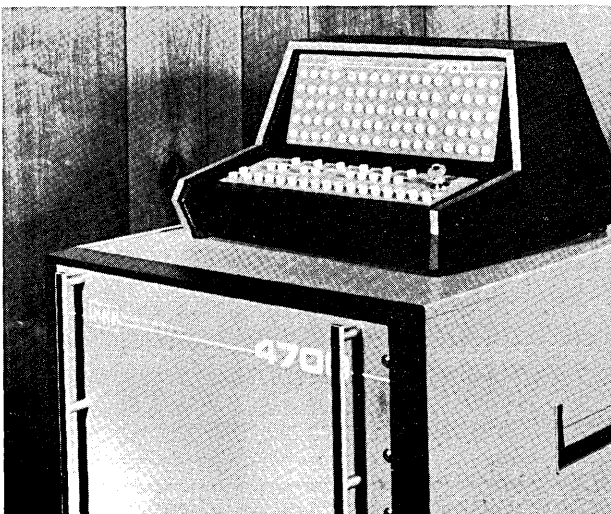

SCC 4700 COMPUTER / Scientific Control Corp., Dallas, Texas — Deliveries on this 16-bit, 920 nanosecond, digital computer are starting this month. The SCC 4700 has Real Time Monitor and FORTRAN IV software in addition to a standard software package. Flexible communications capabilities include: 32 full duplex lines per channel; handling of a wide variety of speed dependent devices and user oriented remote devices; ASCII compatibility; and modular construction to permit system tailoring to specific user needs. Memory is expandable to 65K. (Circle #51 on the Reader Service Card.)

MEMORIES

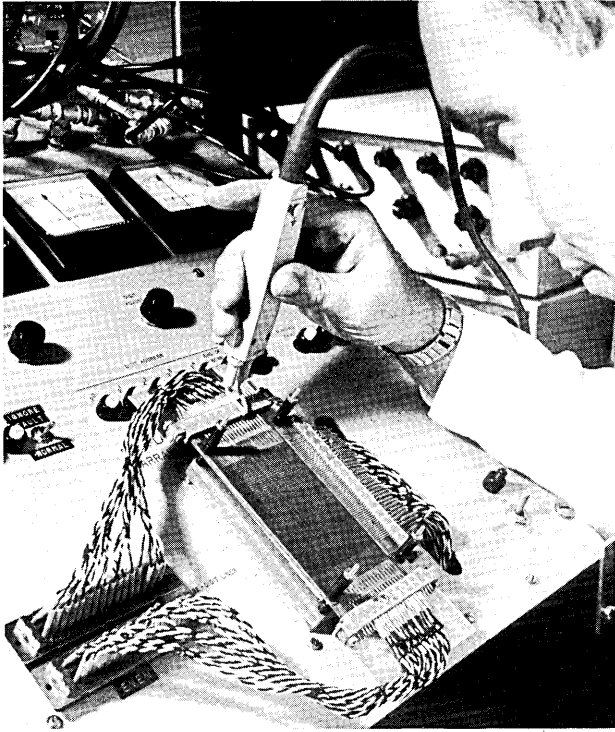

PLATED WIRE MEMORY ARRAY / Electronic Memories, Hawthorne, Calif. — A typical plated wire memory array offered by Electronic Memories contains 64 words of 36 bits and is available in bi-polar or uni-polar modes. Cycle time is 200 nanoseconds, and it has an operating temperature range of -50°C to 100°C . It measures 5 inches in length and is 3 inches wide. In the photo, an engineer (utilizing a special test system built by Electronic Memories engineers) is shown using a differential probe to monitor the output of a typical plated wire array. (Circle #52 on the Reader Service Card.)

DC-51 MAGNETIC CORE MEMORY / Datacraft Corp., Ft. Lauderdale, Fla. — The DC-51 memory was designed for applications requiring non-volatile storage such as CRT Display refresh, data transmission buffering, and data terminals. It is a $2\frac{1}{2}$ D, half cycle random access memory utilizing wide temperature range, 50 mil lithium cores. The core, address and data drive circuits, sense circuits and timing and control logic are mounted as a single printed circuit package. Address and data registers are optional and are contained on an additional printed circuit board. Maximum capacity available is 512×9 or 256×18 . (Circle #54 on the Reader Service Card.)

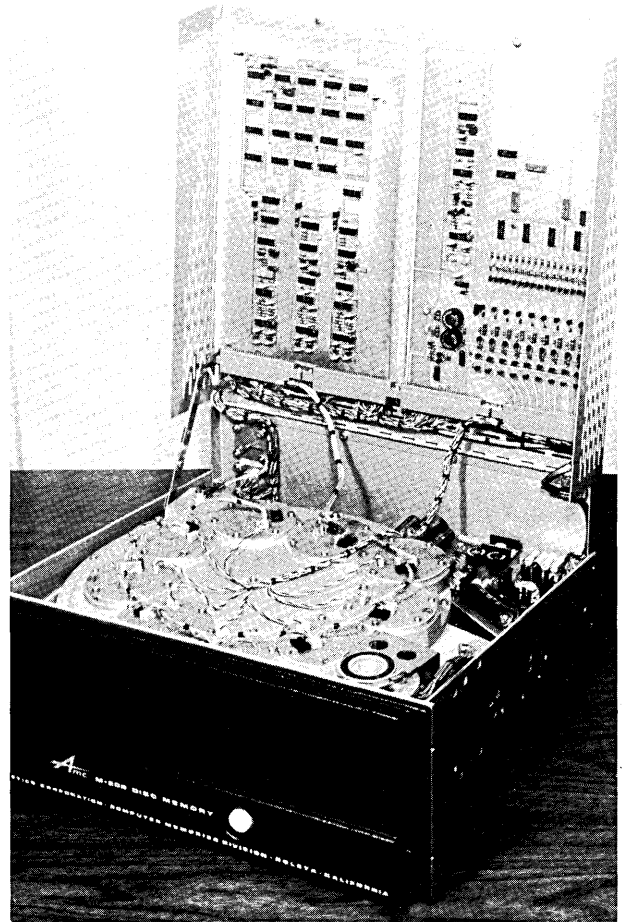
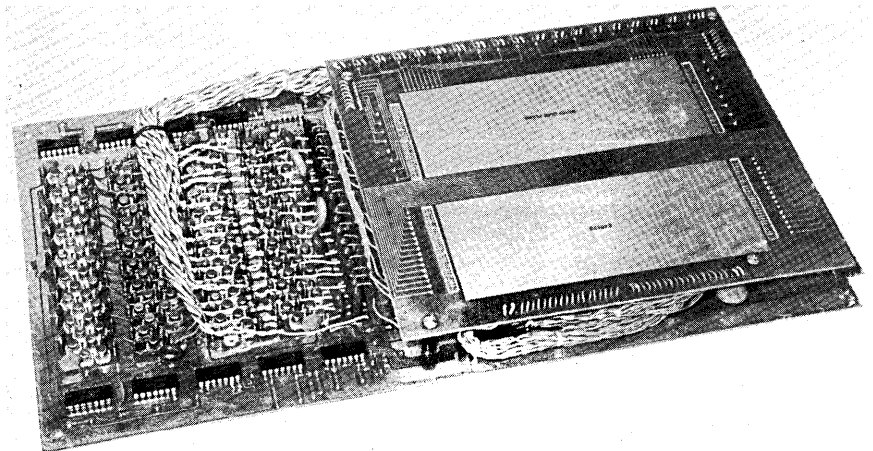

M-200 DISC MEMORY / Applied Magnetics Corp., Computer Memories, Div., Goleta, Calif. — Storage capacity for this head-per-track type mass memory (shown opened) ranges from 426,000 to 3,408,000 bits and average access time is 8.7 milliseconds. The number of data tracks varies from 16 to 128 with 26,624 bits per track. Three timing tracks are included providing a bit clock, sector and origin pulse. (Circle #53 on the Reader Service Card.)

REALTUMER

REALTIMESHARING

goes better with PDP-10
Realtimesharing goes only with PDP-10. Batch processing, real-time and time-sharing. All at once. Right now!

Realtimesharing means sixty-four users can prepare, run and interact with their programs in BASIC, AID, FORTRAN, MACRO, DDT and EDITOR. All simultaneously. Real time-sharing!

Realtimesharing means several real-time experiments can be run and controlled without cutting off the time-sharing users. Nobody has to wait in line. Real-time sharing!

Realtimesharing means PDP-10 can take on batch processing while doing real-time experiments and time-sharing. Real-time-sharing!

Realtimesharing is resource-sharing at its best.
And it's available only from us.

PDP-10
digital
COMPUTERS · MODULES
Maynard, Mass.

Memories

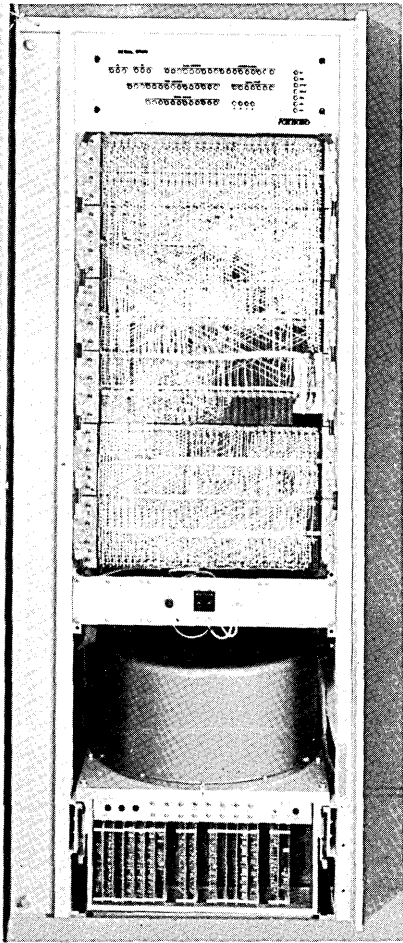

MODEL 97460A DRUM FILE SYSTEM / The Foxboro Co., Foxboro, Mass. — Model 97460A system (shown with door open) has a head-per-track memory and is available with standard capacities of 100,000 to 400,000 words. Average access time is 8.3 milliseconds. (Circle #56 on the Reader Service Card.)

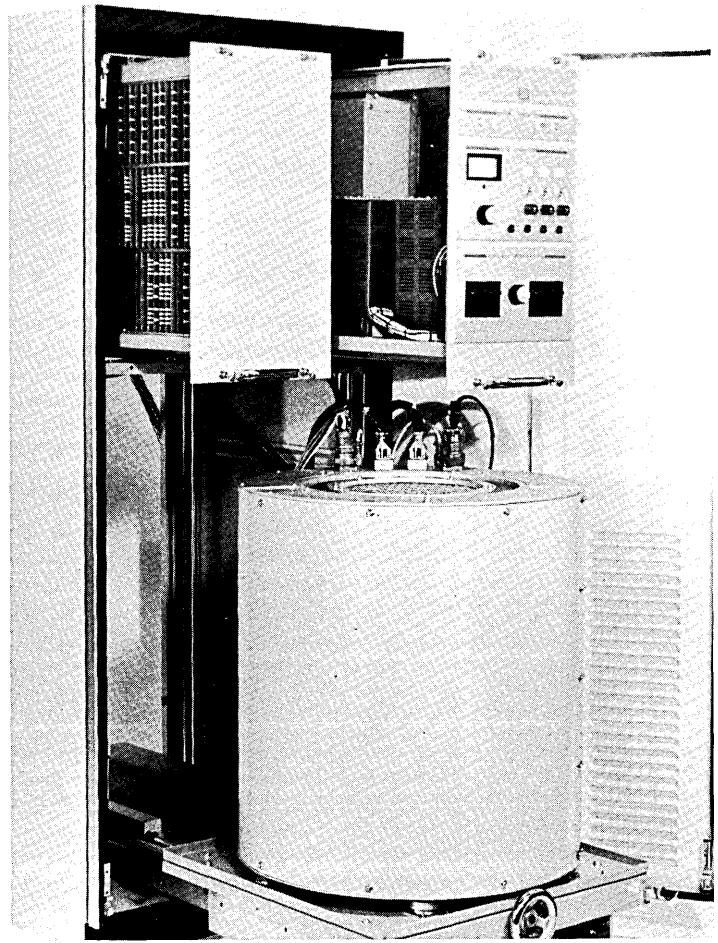

MAGNETIC DRUM MEMORY SYSTEM / General Instrument Corp., Systematics/Magne-Head Div., Hawthorne, Calif. — The equipment shown here is a 20 million bit magnetic drum memory system with an average access time of 8.5 milliseconds. The memory, completely self-contained including its own power supplies, can operate bit serial or up to 8 bits parallel, and has high reliability (less than one recoverable error in $10\frac{1}{4}$ bits). (Circle #55 on the Reader Service Card.)

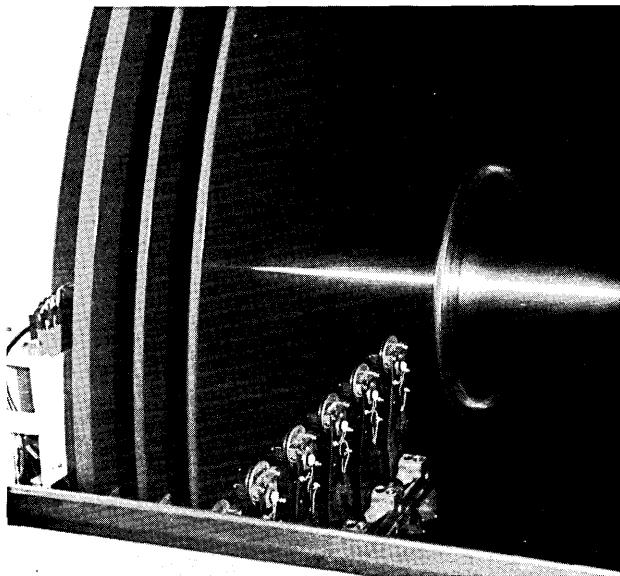

RB10 STORAGE DISK FILE / Digital Equipment Corp., Maynard, Mass. — A number of PDP-10 auxiliary storage options were added during 1968 including the RB10 storage disk file with a capacity in excess of 100-million 36-bit words. PDP-10 users are now provided with a complete incremental range of auxiliary storage, from the half-million word swapping disk (RD10) to the 100 million word disk storage file shown at the left. (Circle #57 on the Reader Service Card.)

Memories

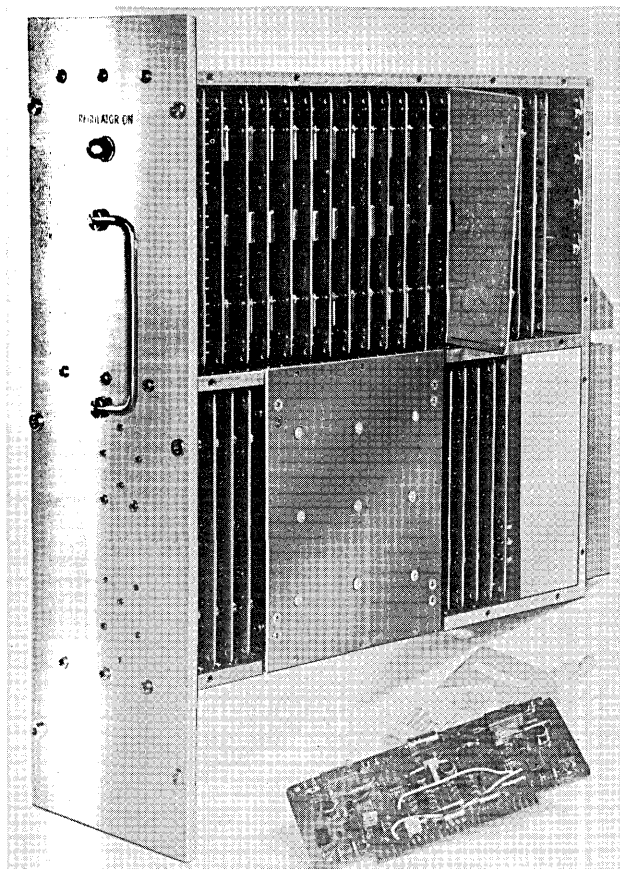

ONE MICROSECOND CORE MEMORY, MODEL CR-95 / Lockheed Electronics Co., Data Products Div., Los Angeles, Calif. — Model CR-95 is available in capacities of 4096 and 8192 words with word lengths variable in 4 bit increments from 8 to 36 bits. Full cycle time is one microsecond with access time less than 500 nanoseconds. CR-95 is designed for application as a memory or buffer in small computers or data systems. (Circle #58 on the Reader Service Card.)

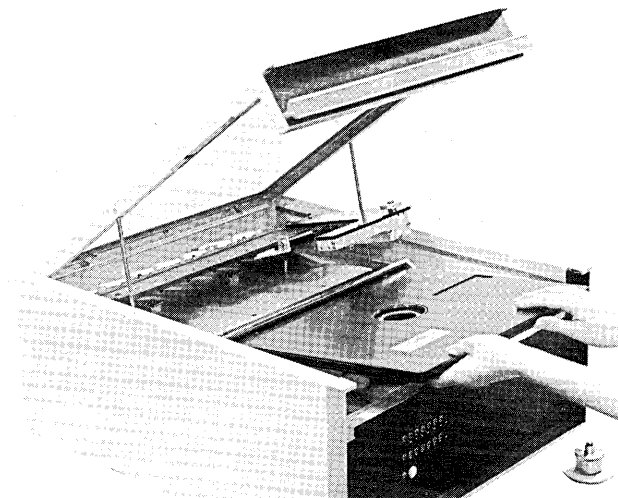

RANDOM ACCESS MEMORIES TYPE MDM-X / Infotronics, Inc., Van Nuys, Calif. — This series of random access computer or video memories uses rigid magnetic discs as a storage medium. The magnetic disc is contained in a protective cassette (see above) which also serves as an interchangeable loading cartridge. The memories provide an on-line storage capacity of up to 25M bit with maximum access time of 25ms per head. A rear view of the MDM-X memory is shown below. (Circle #59 on the Reader Service Card.)

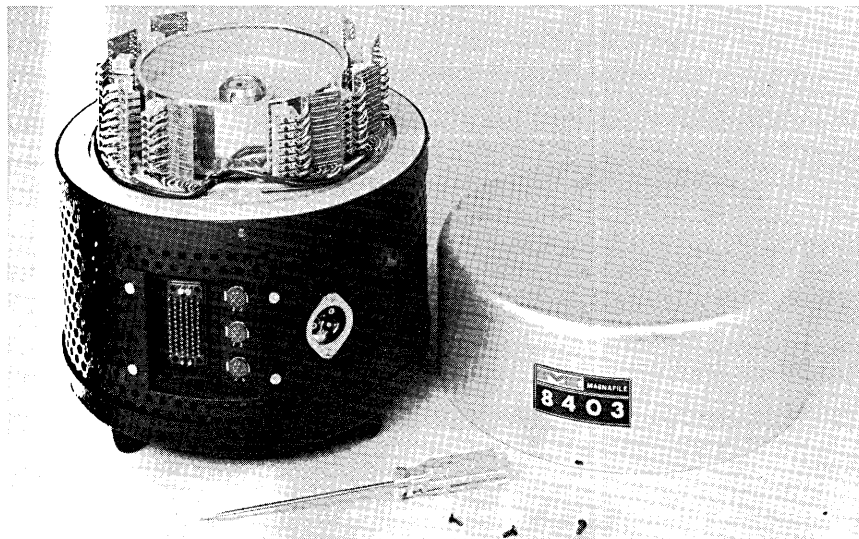
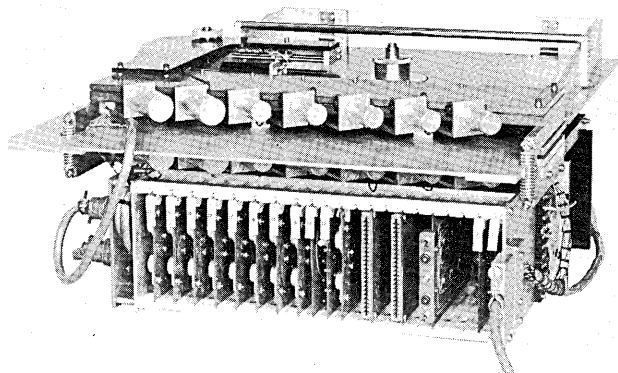

MODEL 8403 DRUM MEMORY / Magnafile, Inc., Phoenix, Ariz. — Pictured at the left with double sealed covers removed, the Model 8403 head-per-track drum memory is a 64 track device with a storage capacity of 1.4 million bits. The Model 8403 provides a medium capacity data base designed for small computer applications. (Circle #60 on the Reader Service Card.)

COMPONENTS

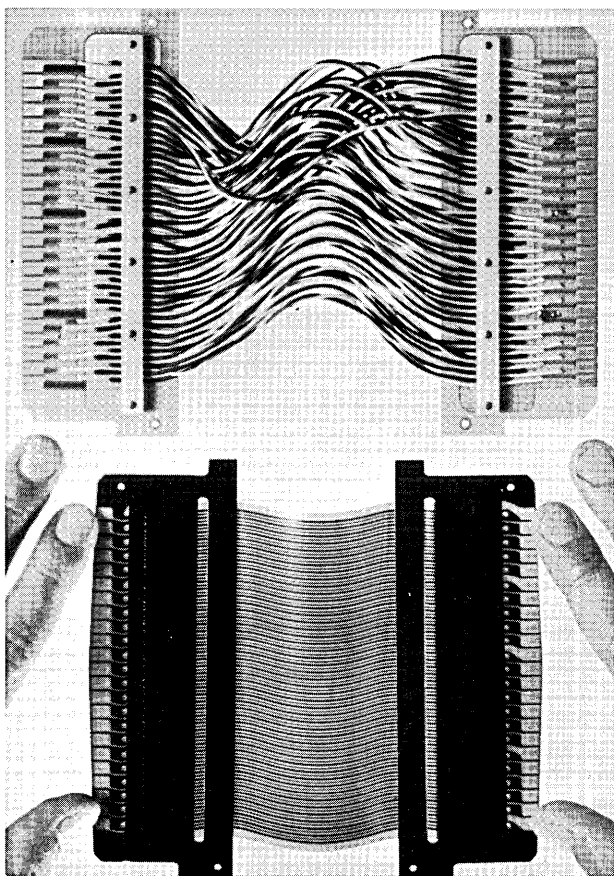

INTRA-FRAME JUMPER / Rogers Corporation, Rogers, Conn. — Relative simplicity of Rogers' computer intra-frame jumper (bottom in the picture) is evident in the photo comparison with conventional jumper using twisted wires. Mass-terminated flat cable of the component is designed for greater reliability. (Circle #61 on the Reader Service Card.)

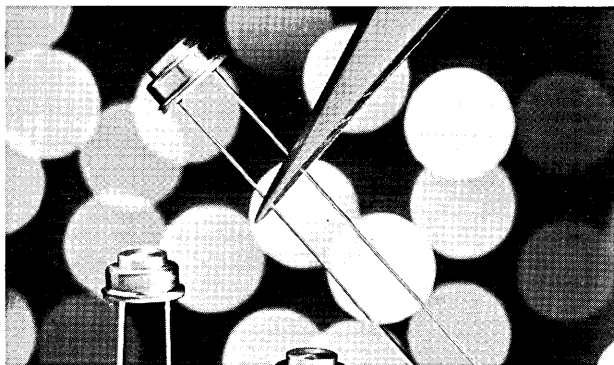

MATSUSHITA PRESSURE-SENSITIVE DIODE (MPS) / Matsushita Electric Corp. of America, New York, N. Y. — These pressure-sensitive diodes are made by bonding such impurities as gold, nickel, and copper to silicon semi-conductors to increase their sensitivity to pressure. Possible uses of the MPS diode are non-contact solid state switches in computers and pressure sensors that would measure weight, acceleration, stress and strain. (Circle #62 on the Reader Service Card.)

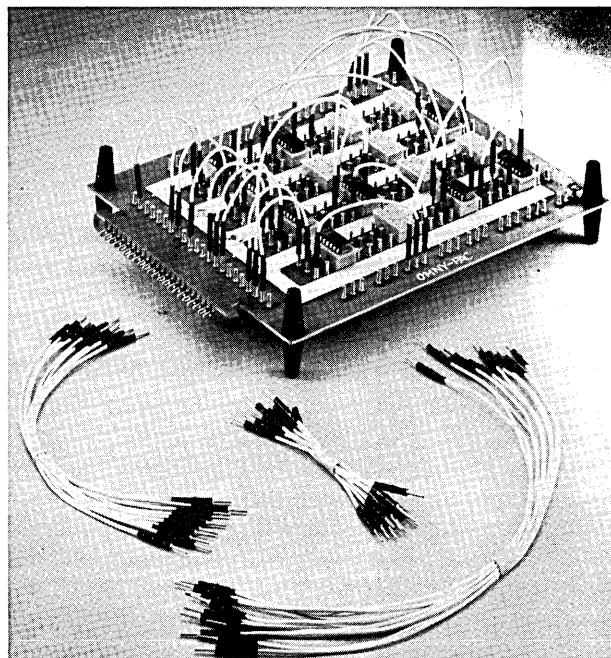

PATCH CORDS / Methods Manufacturing Corp., Rolling Meadows, Ill. — Pre-assembled patch cords, available in four different lengths and colors, are an asset to bread-boarding, testing and small production quantity work. The patch cords have standard .040 diameter, tin-plated plug-gable pins. They are compatible with MBB-1000 and 2000 "Omny-Pac" circuit panels. Standard packages sold consist of ten patch cords having the same length (4", 8", 12" or 16") and in one color (white, red, green or black). (Circle #63 on the Reader Service Card.)

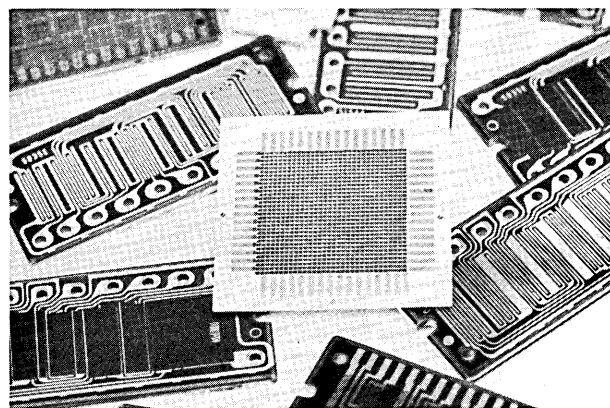

PHOTOCONDUCTOR ARRAYS / Hewlett Packard, Palo Alto, Calif. — The arrays of photoconductors are fabricated by thick-film techniques on ceramic substrates and can be produced to accept additional active or passive components. Available to other equipment manufacturers, the arrays are custom-designed to meet customer requirements for switching, coding, translating, reading, or position-sending applications. (Circle #64 on the Reader Service Card.)

PERIPHERAL EQUIPMENT

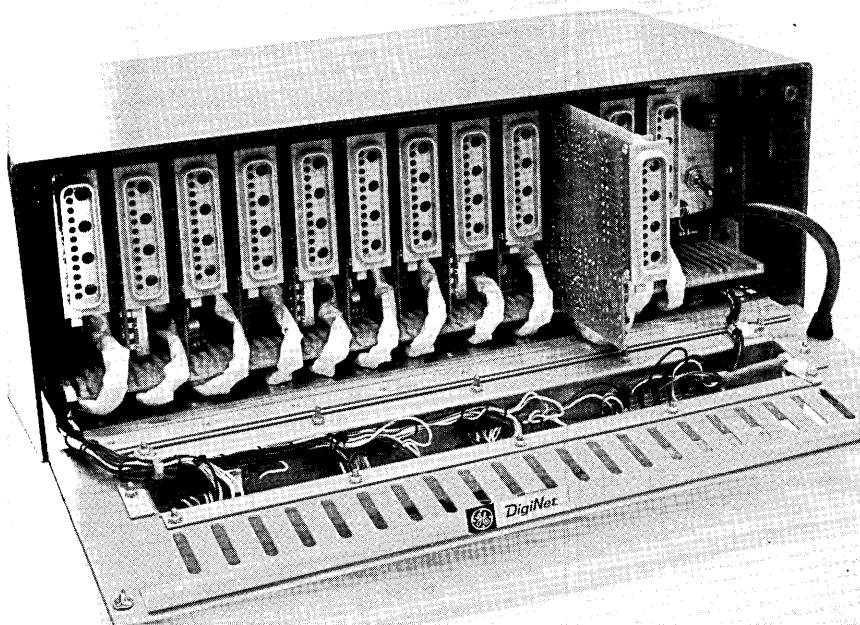

DIGINET SERIES / General Electric Co., Communication Products Dept., Lynchburg, Va. — GE's "DigiNet Series" is a broad family of solid state data sets for digital transmission between digital machines and transmission systems. At the left is the DigiNet 150 data multiplexing system (shown open). This system enables computer time-sharing centers to use dedicated transmission lines more efficiently by multiplexing up to 15 simultaneous full duplex time-sharing data communications channels onto a single voice grade telephone circuit. (Circle #80 on the Reader Service Card.)

ADAGE GRAPHICS TERMINAL (AGT) / Adage Inc., Boston, Mass. — Designed for use in interactive graphics applications, this general-purpose display system provides communications with the user by means of CRT display output and light pen, joystick, 2-D tablet and keyboard inputs. Each AGT incorporates a stored program computer which is used to refresh the CRT, to control information flow to and from the various input/output devices at the terminal, and also to perform image manipulations within the terminal itself. The AGT can be connected to a central computer system or it can be used as a "standalone" system. (Circle #81 on the Reader Service Card.)

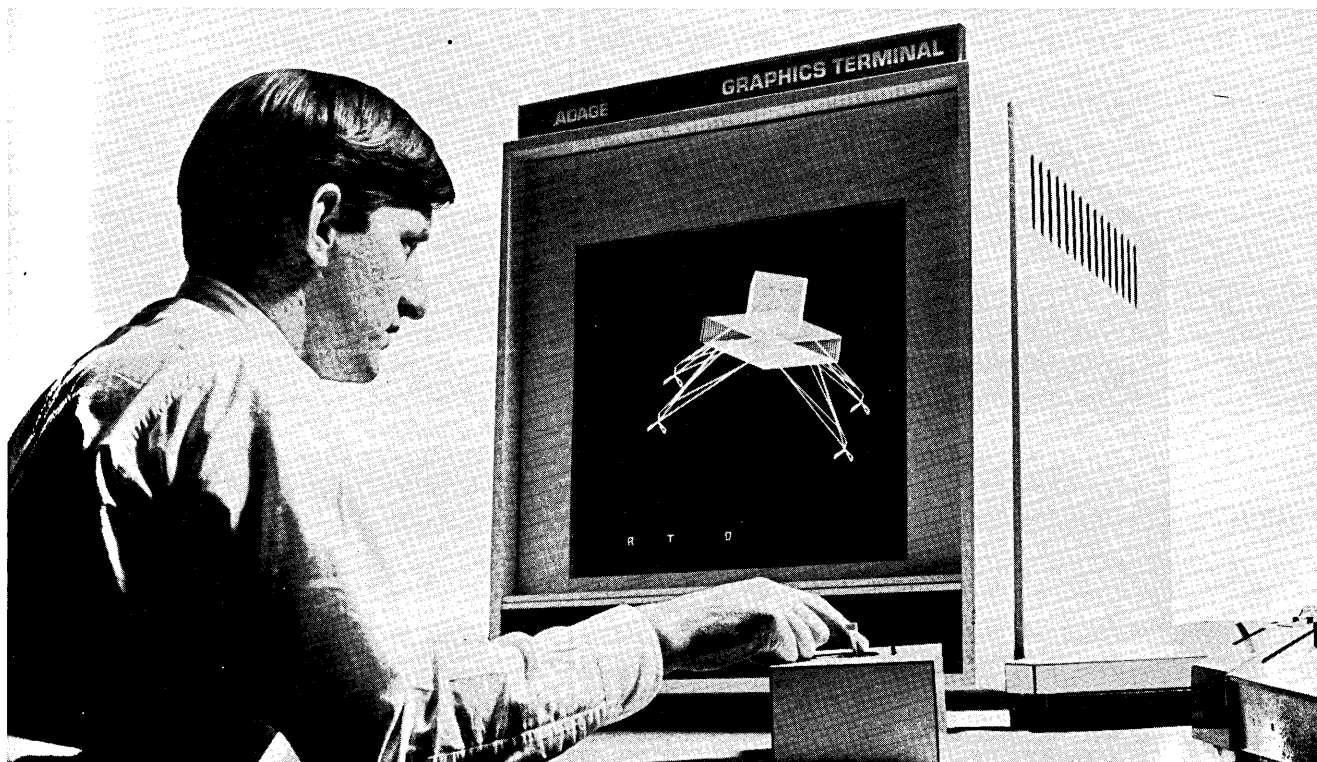

Peripheral Equipment



MULTIPLE PAGE KEYBOARD (MPK) / Philco-Ford Corp., Houston, Tex. — The Multiple Page Keyboard (MPK) allows the operator of a computer-oriented system to control 327,360 functions from a small keyboard through the use of removable books of 10 plastic pages. The books are inserted by latching two catches at the centerfold. As a book is inserted, coded buttons are depressed to enable the computer to identify the book. Other coded switches provide identification as the book is opened, or as pages are turned. The MPK is designed to work in conjunction with a cathode ray tube (CRT) in displaying information for the operator. (Circle #77 on the Reader Service Card.)

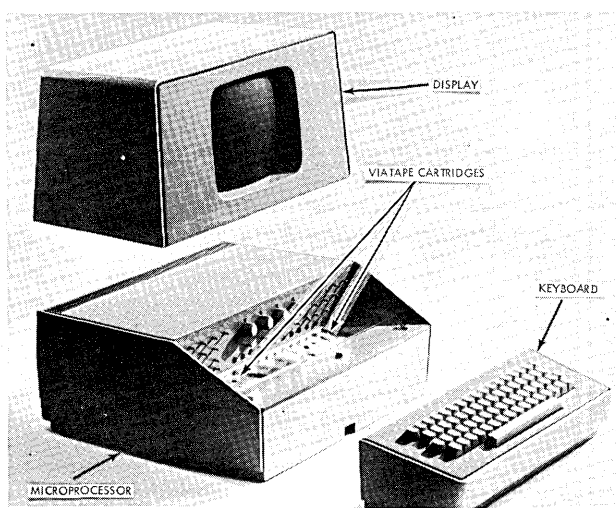

VIATRON SYSTEM 21 / VIATRON Computer Systems Corp., Burlington, Mass. — This desk-top data management system, using large-scale integrated circuitry, will process, display and store all kinds of information on minute 2½" x 4" tape cartridges. The exploded view of the system at the left shows the various components as they could appear if set up to operate separately from each other. As data is typed on the keyboard, it appears on the display screen and is recorded on a special cartridge for storage. Once on the cartridge, the information can be stored or fed into a translator for computer input or into a card translator for automatic punching of cards. The System 21 is designed to allow anyone who can type to process data for a computer, and it is flexible enough to be used in the home. (Circle #79 on the Reader Service Card.)

COM-PACT TERMINAL / Honeywell Electronic Data Processing, Wellesley Hills, Mass. — The battery-operated COM-PACT terminal requires no knowledge of computer operations for use, only knowledge of special codes required to call the computer through the multi-frequency tones generated by the 16 keys of the device is needed. A businessman is shown checking inventory by audio response from his own office. COM-PACT allows him to "talk" with a computer over any telephone line via an acoustical coupling. He hears his answer through a volume-controlled speaker in the device after the answer is generated from the vocabulary in the computer's audio response system. The COM-PACT terminal will be available in the third quarter of 1969. (Circle #78 on the Reader Service Card.)

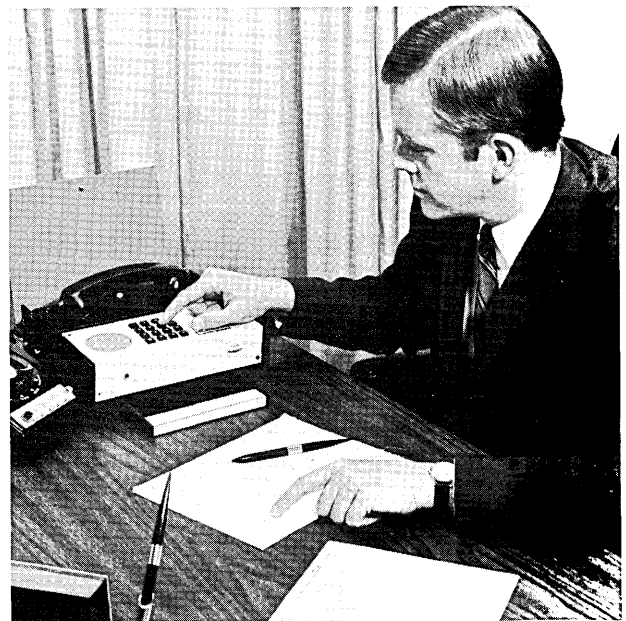

Peripheral Equipment

SOLID STATE KEYBOARD / Micro Switch, a division of Honeywell Inc., Freeport, Ill. — The heart of this solid state electronic keyboard (at the right) is a "magnet actuated integrated circuit". The "exploded view" of the keyboard module below shows "chip" wafer (in foreground) containing about 350 integrated circuit chips. The wafer is about the size of a 50-cent piece. An individual chip, 40 one-thousandths of an inch square, is displayed directly above the wafer. From left to right the Honeywell switch module also includes: mounting rail; lead frame with four terminals extending to the left and the integrated circuit chip shown mounted near the right edge; plunger with magnet shunt member that holds two magnets; switch housing and key button. A standard keyboard consists of four 17-unit rows that provide up to a 69-key array, including the space bar. (Circle #75 on the Reader Service Card.)

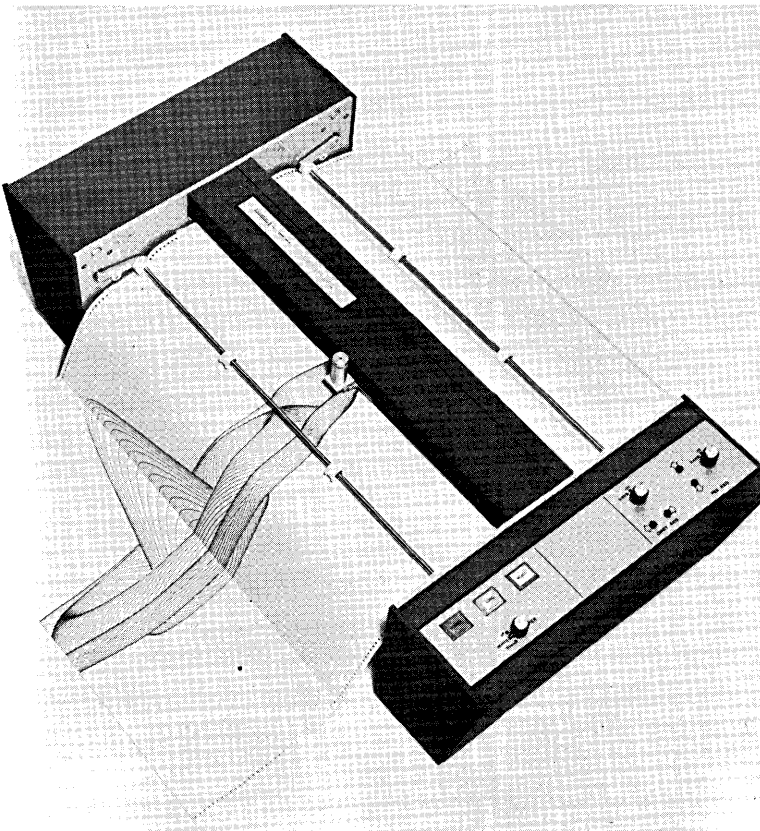
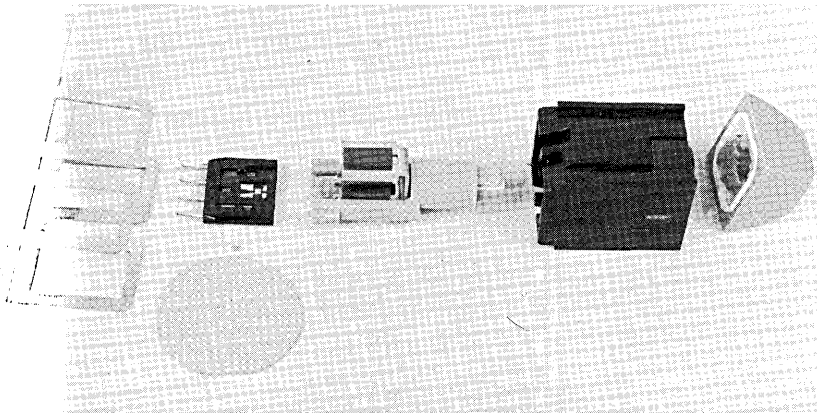

COMPLØT DP-8 DIGITAL PLOTTER / Houston Instrument, Bellaire, Tex.

— The DP-3 plotter uses the Z-fold chart paper with plotting surface a full 22" wide by 144" in length. This provides standard drawing sizes merely by tearing at the appropriate perforations. DP-3 drive motors have two mounting positions; this enables the user to rapidly and easily change from .010" step size to .005" step size. Plotting rate is 300 increments per second. It can be used on-line, off-line or at remote time sharing locations. (Circle #76 on the Reader Service Card.)

Peripheral Equipment

FILMSTRIP PROJECTOR / Mast Development Co., Davenport, Iowa — High-precision filmstrip projectors are capable of random selection and accommodating 200 or 300 frames of information. The units take the shortest route from one frame to the next frame selected. A patented servo mechanism, essentially a pre-determining counter, is the heart of the system. The specific visual needed comes into view within seconds upon either manual or computer command. The units are made for all types of information display: in troubleshooting control consoles, industrial panels, trade show displays, and cathode ray tube systems. (Circle #72 on the Reader Service Card.)

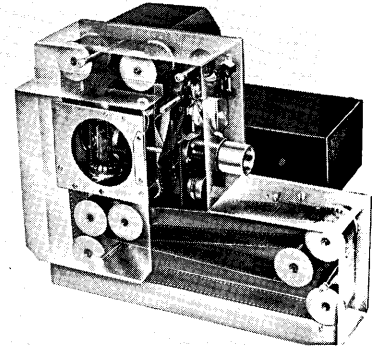

SERIES TC500 ELECTRONIC TERMINALS / Burroughs Corp., Detroit, Mich. — The Series TC500 Terminal Computers prepare and communicate information between a remote location and a central computer system. The terminals have the ability to pre-process and concentrate data which is to be transmitted, and to "burst" or expand data received by the same or other TC500 terminals. They have independent data communications and main memory logic which permit simultaneous receiving or transmitting of a message while the operator is handling a previous message or building a new message in memory. Depending upon their memory size, the various models can perform a variety of tasks including programming, editing, and other housekeeping chores previously performed by the central computer prior to actual processing. (Circle #74 on the Reader Service Card.)

DS 9100 DATA STATION / Sangamo Electric Co., Springfield, Ill. — This desk-like Data Station provides for keyboard information to be recorded directly on magnetic tape for immediate and rapid assimilation by a computer. The compact console contains a tape system (located in drawer), keyboard, alpha-numeric display and magnetic core memory. The status of data in the core memory is continuously depicted in English, relieving the operator of the task of code translation. Sangamo's DS9100 Data Station received the Award of Excellence for the Computer and Electronic Data Processing Equipment category at the WESCON Industrial Design competition this year. (Circle #73 on the Reader Service Card.)

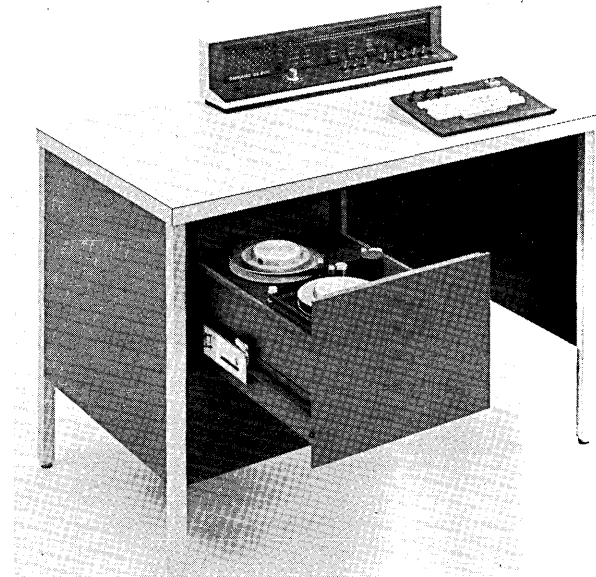

Peripheral Equipment

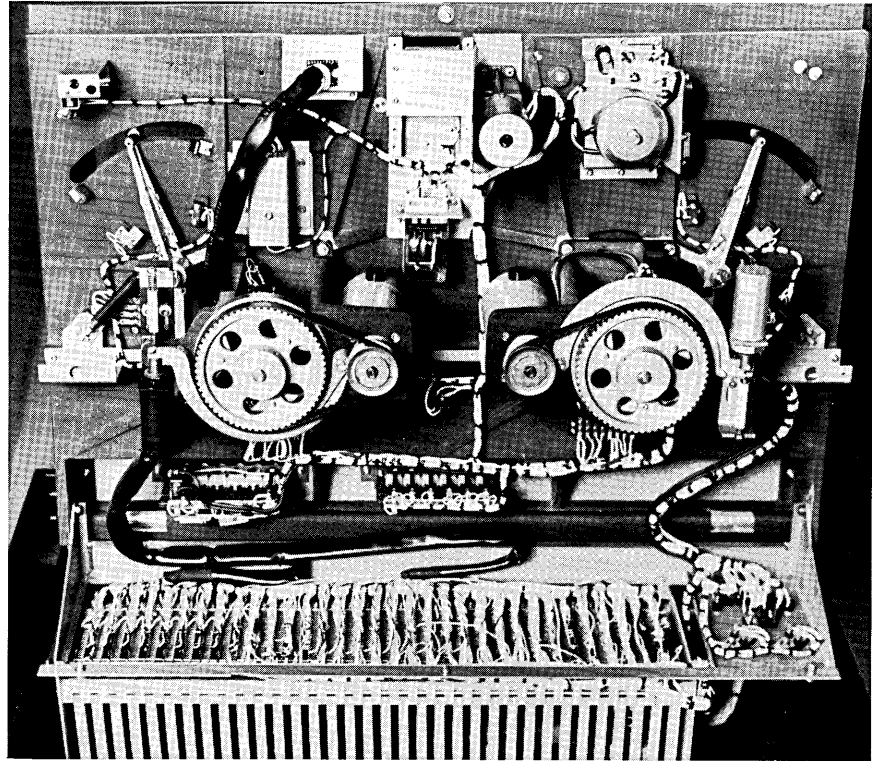
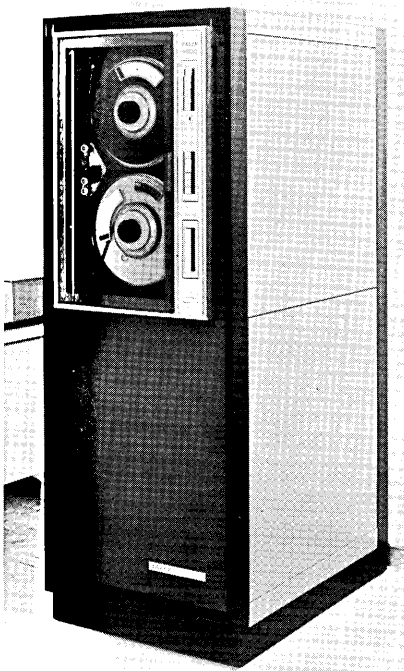

SYSTEM 4031 MAGNETIC TAPE TERMINAL / Tally Corporation, Seattle, Wash. — The computer compatible Tally System 4031 magnetic tape terminal provides point-to-point data communications at speeds of 1200 words per minute serially or 600/720 words per minute in a parallel format over ordinary telephone lines. It is completely compatible with all other Tally send or receive terminals in any given transmission network. The recording density can be selected to 200, 556, or 800 characters per inch on 7 track tape or 800 characters per inch on 9 track tape. (Circle #71 on the Reader Service Card.)

MDR-1000 DOCUMENT READER / Motorola Instrumentation and Control Inc., Phoenix, Ariz. — The MDR-1000 is a low-cost, near real-time data input device. The reader interfaces between data source and computer or I/O devices. The machine reads punched, preprinted, or pencil-marked cards or pages. Raw data is translated directly to computer language and entered into the information processing system. Operation of the reader can be manual or automatic. No special training is required. (Circle #70 on the Reader Service Card.)

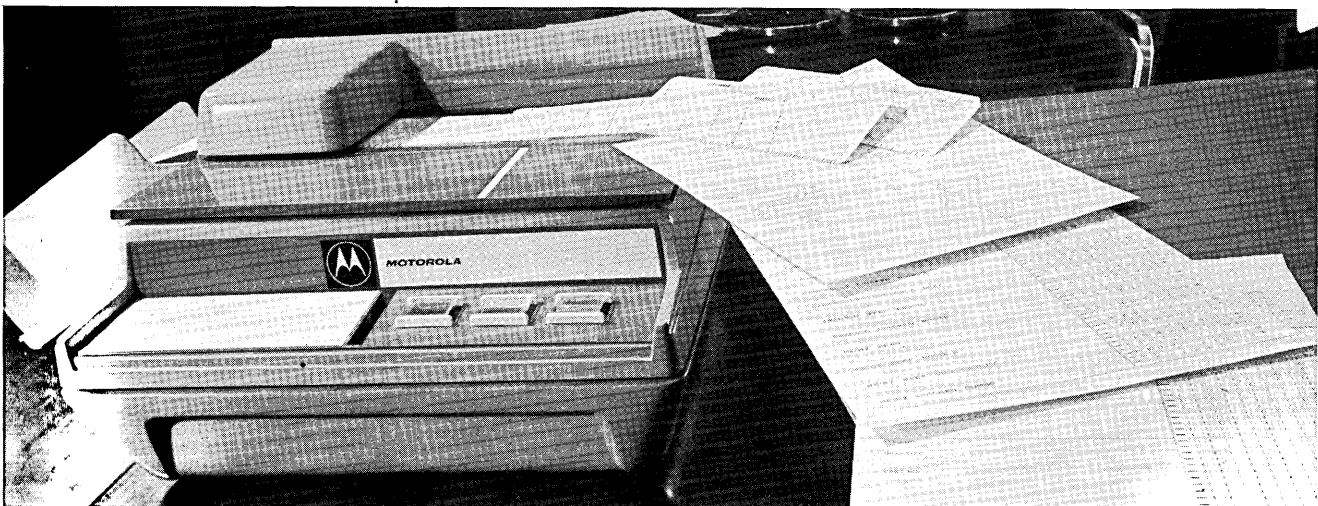

Peripheral Equipment

MULTI-COPY SERIAL PRINTER / Tally Corporation, Seattle, Wash.

— Sixty characters a second, 600 words a minute of computer or communication data, are printed by the tiny printing "head" — one inch long and one-quarter inch in diameter — of Tally's business-oriented multi-copy serial printer shown below. The 64-character font cylindrical print element (shown at the right) revolves and moves up and down as it is positioned, character-by-character, across the page. The printer's speed is four times faster than an automatic typewriter and six times faster than a teletype machine. (Circle #68 on the Reader Service Card.)

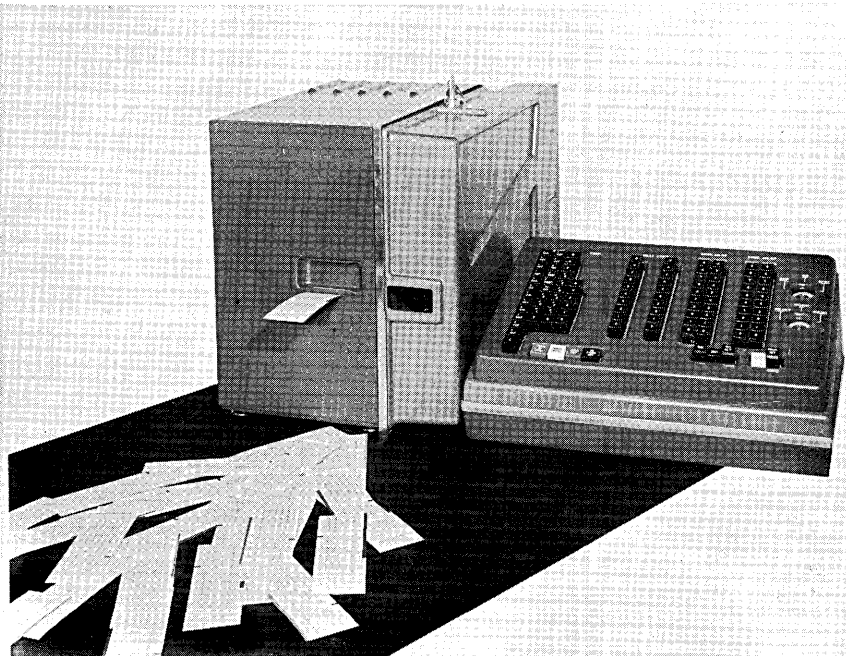
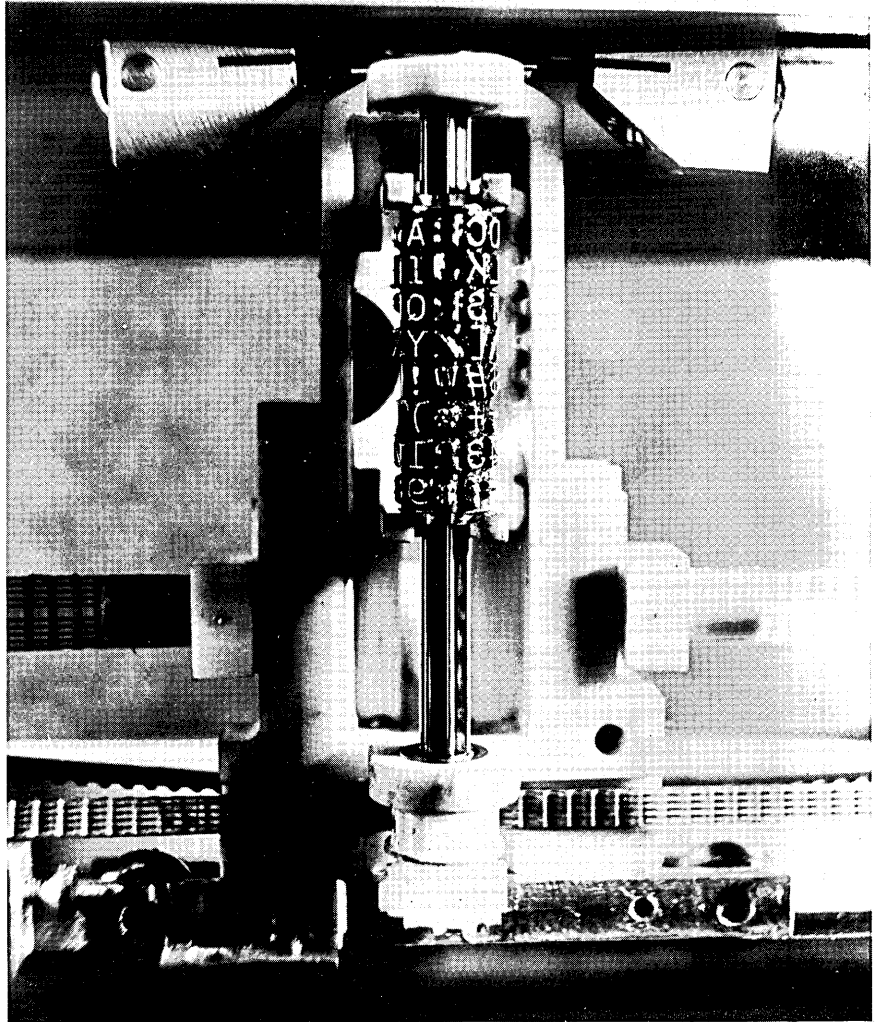
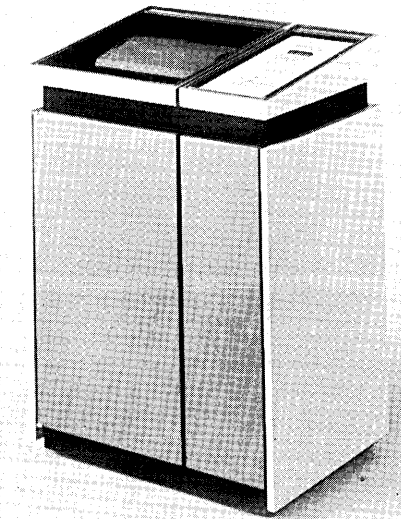

ELECTRONIC BOX OFFICES / Di/An Controls, Inc., Boston, Mass. — In New York, Chicago, and Los Angeles, "electronic box offices" have begun to appear at places convenient to shoppers and travelers in general. These terminals are man/computer interfaced and are linked by commercial telephone lines to central computers having in memory all available seats and prices for various scheduled entertainment attractions. The terminals are made up of a high-speed printer, a telephone modem, power supply, and key-board, and are on line using real time ticket creating machines. Instantickets, as Di/An calls them, are produced on pre-printed card stock. (Circle #69 on the Reader Service Card.)

UNIVAC 1557/1558 GRAPHIC DISPLAY SUBSYSTEM / Sperry Rand Corp.,

UNIVAC Division, Philadelphia, Pa. — Using a light pen, an engineer designs an electronic circuit on the screen of the 1557/1558 Graphic Display Subsystem. From a number of component symbols shown in the upper part of the screen he can select those components he needs to construct the circuit on the grid provided by the system. The 1557/1558 Subsystem which uses a digital deflection technique can be used for direct interconnection with a large-scale computer systems or for remote operation with connections to a central processor via voice grade or wideband communication facilities. (Circle #66 on the Reader Service Card.)

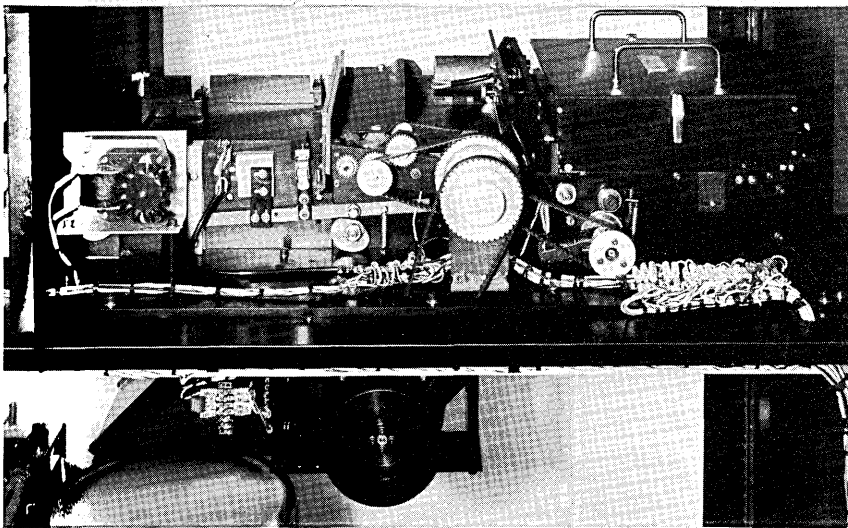
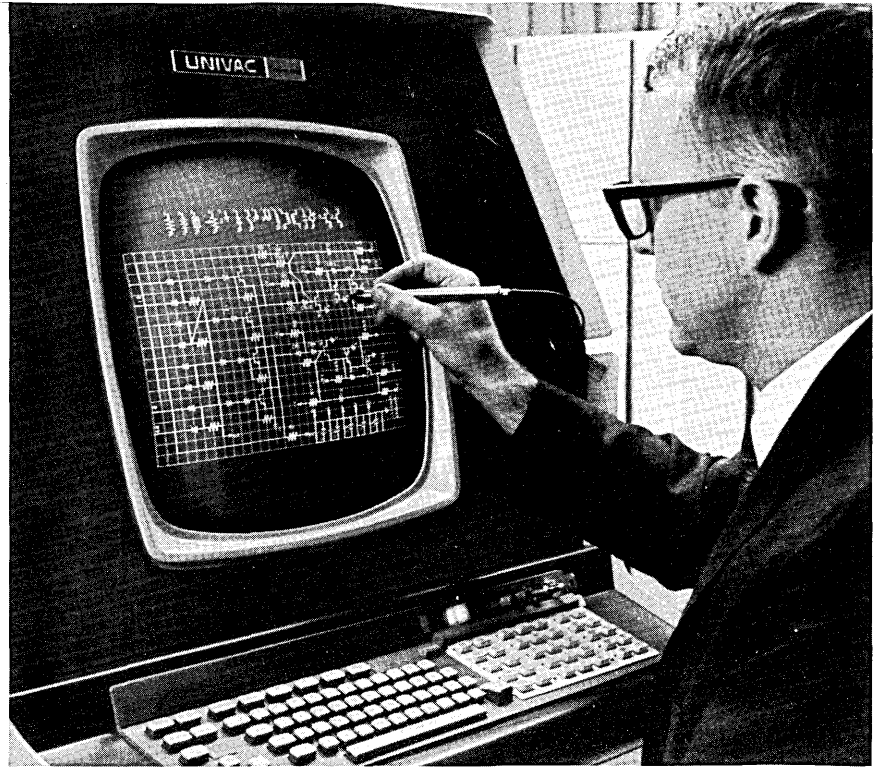

RAPCOR SYSTEM, SERIES 725 / OPTOmechanisms Inc., Plainview, L. I., N. Y.

— Quality hard copy of computer and video outputs can be generated in seconds with the Series 725 (shown open above). The system will photographically record all types of data and imagery, including alphanumeric, graphical, and continuous tone imagery. Data and imagery are recorded instantly on 8½" x 11" paper at a rate of four sheets per second. Dry hard copies are delivered in a continuous flow every eight seconds. The system, contained in a light-proof mobile console cabinet (shown at the right), has access doors for normal operation and maintenance activities. (Circle #67 on the Reader Service Card.)

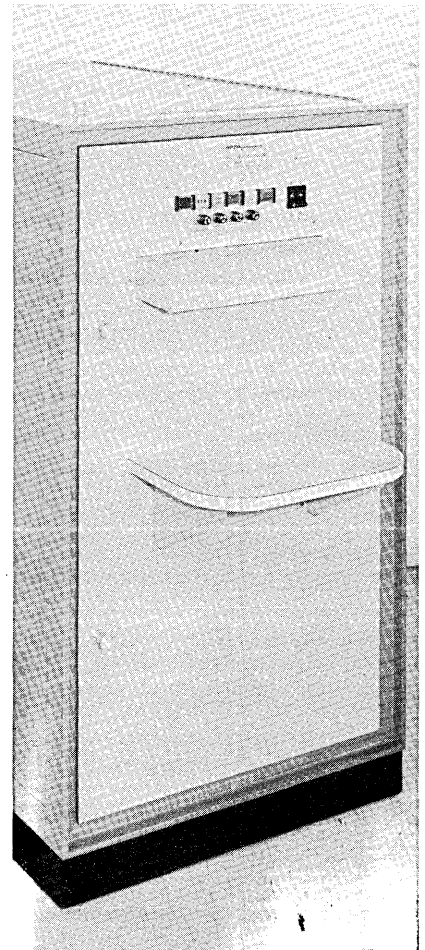

DATA PROCESSING ACCESSORIES

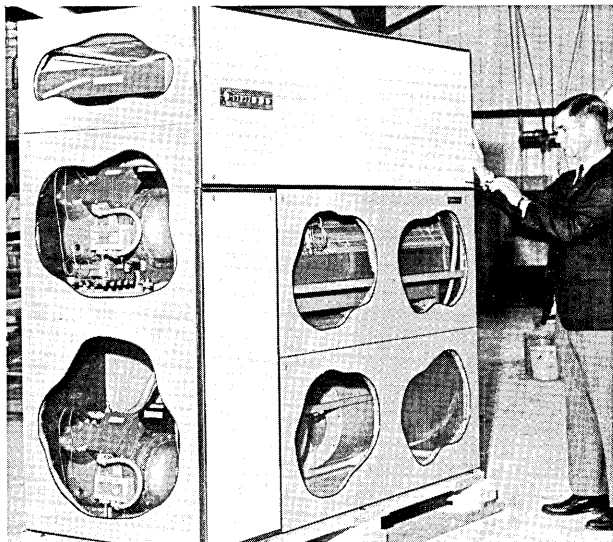

COMPUTER CLIMATE CONTROL UNIT / Liebert Corporation, Columbus, Ohio — This system was displayed at the Climate Control Equipment Show in Frankfurt, Germany recently at the request of the U. S. Department of Commerce. Shown is a typical 2100-pound, 10-ton capacity floor-flow unit with special plexiglass panels for inspection of technical features. The panels showcase the A-frame cooling unit, infrared humidifier, and a solid state universal control sensitive to the close humidity and temperatures specified for computer rooms. (Circle #83 on the Reader Service Card.)

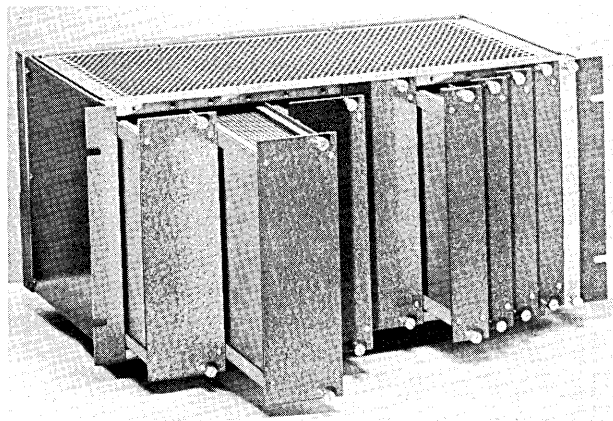

BIN-AND-MODULE SYSTEM / Benney Electronics Ltd., England — The bin-and-module system for housing electronics equipment (known as Beni-Bin) has an extra half-module space in each bin for accessories. Each module has extrusions drilled and tapped ready for mounting printed circuit boards and other components. The extra space, at the right-hand side of the bin, is intended for mounting switches, indicator lamps, test sockets, etc., or for a voltage check facility. (Circle #86 on the Reader Service Card.)

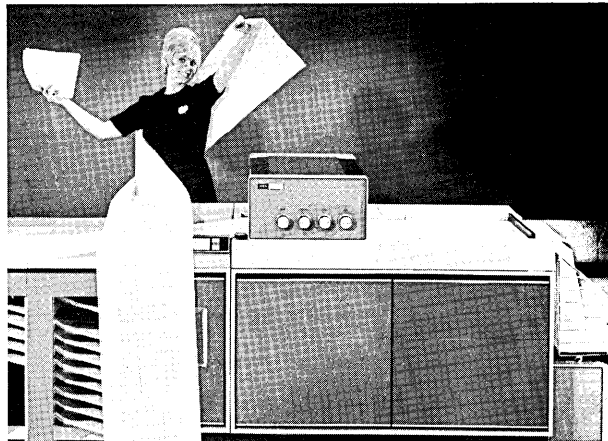

COMPUTER FORMS PRINTER / Xerox Corp., Rochester, N. Y. — Copies of printout from computers and other data processing equipment can be made on the Computer Forms Printer. Up to 30 copies of each print out page can be copied, reduced to 11 x 8½-inch format and collated automatically from a single copy of the data processing fanfold report on the machine. The printer copies at a speed of 40 copies-per-minute on ordinary bond paper. (Circle #85 on the Reader Service Card.)

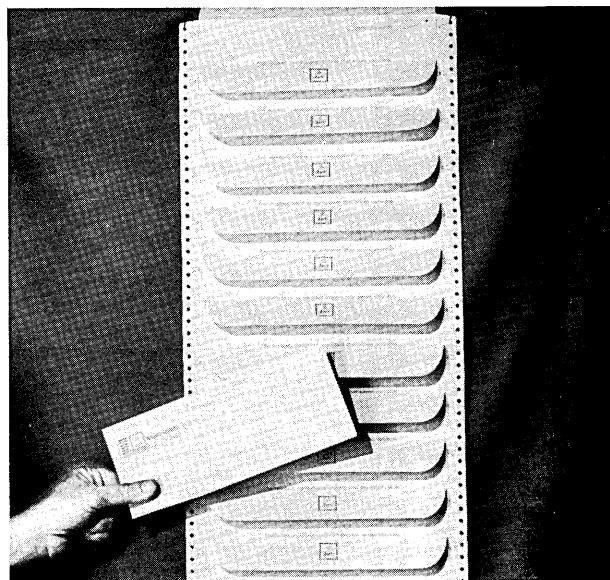

COMPUTER-PAK / Continuous Envelope Sales, Division of Pak-Well Paper Industries, Inc., Phoenix, Ariz. — Developed especially for computer systems applications, Computer-Pak is a continuous web of envelopes, in roll form, that can be fed through computer-printers at high speed. After the pin hole strip is removed, the finished appearance of a Computer-Pak envelope is that of a conventional envelope. (Circle #84 on the Reader Service Card.)

MISCELLANY

RECORDING DISKS AWAIT ASSEMBLY /

Honeywell Electronic Data Processing, Wellesley Hills, Mass. — Several stacks of computer information recording disks are shown awaiting assembly at Honeywell's plant in Newton, Mass. The record-like disks are 14 inches in diameter. They are made of thin aluminum coated with a durable magnetic recording material. When assembled into three different sizes of disk packs, they are used to store large quantities of information for processing by a computer.

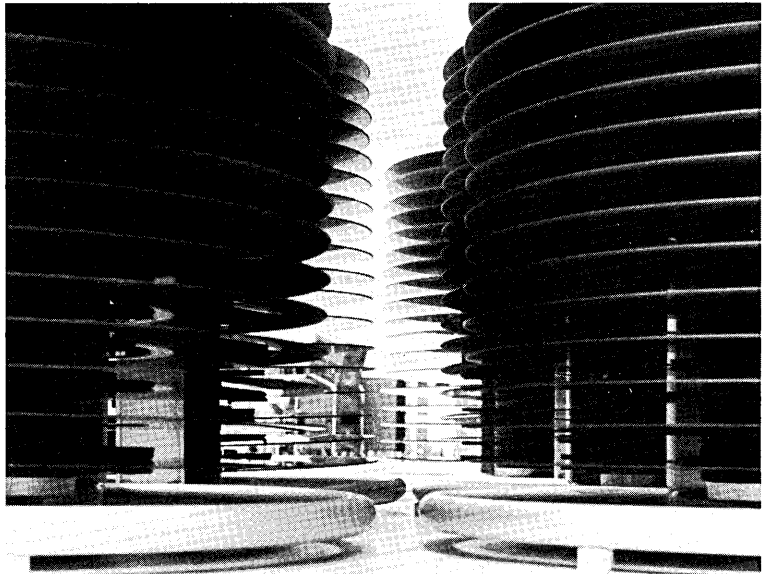

COMPUTER-ASSISTED CATTLE JUDGING / The American Hereford Assoc.,

Kansas City, Mo. — The first on-site computer judging program recently helped ranchers and breeders evaluate Hereford bulls at the American Royal Livestock Show in Kansas City, Mo. About 1,000 Hereford ranchers and breeders analyzed 27 bulls in three classes by standards they seek in an animal. Noting their choices on cards, the stockmen saw their answers keypunched and fed into a computing system on a truck in the arena. The tallies were the first of their kind in Royal history and, a spokesman said, apparently the first use of a computer for immediate, on-site tabulation.

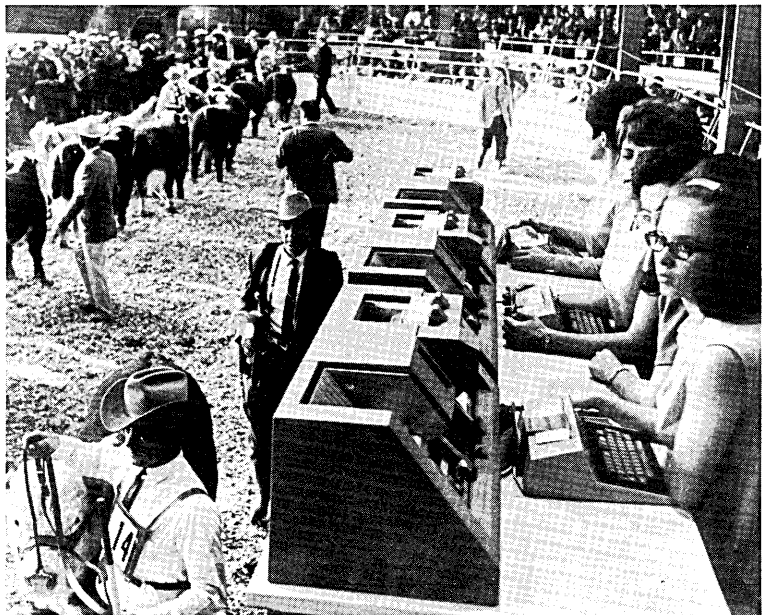

PACKAGE COMPUTER ROOM / Westinghouse Architectural Systems Dept.,

Grand Rapids, Mich. — Design of the room and manufacture and installation of all components (raised-floor system, partitions, ceiling, air conditioning, lighting, and even light switches and cover plates) are part of this preengineered packaged computer room that includes everything but the computer. The package has the design flexibility to be custom engineered in modules to fit the individual needs of the user. Moreover, an entire room can be remodeled, enlarged, or totally relocated without scrapping components.

(Circle #87 on the Reader Service Card.)



Needed: Peopeware

*Swen A. Larsen, Pres.
Computer Age Industries, Inc.
10604 Warwick Ave.
Suite 203
Fairfax, Va. 22030*

"The problems of the computer industry can pretty much be laid to one source — shortage of qualified personnel, the major problem of the industry. Systems analysts, EDP managers, engineering and marketing people, people qualified for every aspect of computers are in increasingly short supply."¹

The salient point in this observation is that qualified people are in *increasingly* short supply.

Inaccurate Predictions

If there is one thing that has been consistent throughout the development of the computer industry, it has to be our inability to project with an appreciable degree of certainty the future of EDP. I suppose we can say that this inability began in the late 1940's when Dr. John W. Mauchly, father of the U. S. computer industry, estimated that only four or five large U. S. companies would ever have real use for a computer. Ten years later, a leading market researcher predicted annual sales of less than \$1 billion to nongovernment users in 1968, a figure that was surpassed four years ago.

Current estimates suggest an explosive growth of up to \$10 billion in new computer installations in the world market over the next five years. And Jacque G. Maisonrouge, Vice President for European Operations for IBM World Trade in Paris, recently suggested that within ten years, the computer industry will become the next truly great international industry — after oils and automobiles. And it has been forecast that in the next couple of years we will need to train 100,000 more programmers, 130,000 more analysts, and 50,000 more EDP managers and supervisors.

If these current predictions are accurate (or are surpassed like so many have been in the past), where does this leave us five or ten years from now? The all too obvious answer is that we must improve our training capability.

Public Schools

Traditionally, industry has been able to turn to the public schools of our country for its labor supply. The record of our educational system over the years in meeting the needs of industry has been admirable, but are public schools meeting the needs of the computer industry?

Dr. R. Louis Bright, the Associate Commissioner of Education in the United States, maintains that they should:

"... the computer is likely to have a far greater impact on our social system than most people, even the writers on the subject, realize today. Therefore it is imperative that the average citizen be aware of what a computer is and what it can and cannot do so that he can make some stab at separating fact from fancy in what he reads. This means that all

high school graduates should have some exposure to instruction in the concepts involved in computer technology." Mr. Halperin went on to point out that "... any liberal arts student graduating from a four-year college today who does not receive instruction in the use of computers is being severely cheated in his education."²

There may be some differing opinions about whether our public educational institutions are meeting these goals. In defense of our public institutions, however, it must be made very clear that their abilities in the field of computer training are largely a function of economics. If you and I, as taxpayers, were insistent upon results and willing to provide the necessary funds, our public schools would respond.

Private Schools

The other type of training institution is, of course, the private school. Typically in our economy, when gaps in the system become apparent, someone is usually ready to rush in to fill the gap if it presents an opportunity for profit. Whether we like it or not, this is the situation we find ourselves in today with a proliferation of private computer training schools. I am reminded here of the situation that arose after World War II when private schools sprang up all over the United States to enter the lucrative market engendered by the G.I. Bill and the desire of discharged veterans for training. Many of the school operators in those days were outright charlatans, and so too are many of the operators of private computer schools today. I call these people "operators" because they have no concept of what is required to provide adequate training for usable computer skills.

Happily, professionals in the computer industry are becoming concerned over this abuse. The Association for Computing Machinery was one of the first to take a positive step in the direction of standards with the formation of the ACM Accreditation Committee. The Data Processing Management Association and the Systems and Procedures Association have also expressed an interest in this much-needed effort.

Technicians and Professionals

Many of our problems in a discussion of this area of training can be simplified with a definition of terms. It is important that we do not confuse the output of the private school with the output of our universities when we consider such a skill as that of the programmer. I like to consider the private school graduate as the technician and the college graduate as the professional. Stated in other terms, the good private school — and there are many — provides intensive training courses, whereas the university is concerned with a broad education.

1. "Personnel Shortage Main Industry Trouble Spot", *Electronic News*, April 29, 1968, page 44.

2. *Proceedings of the Engineering Systems for Education and Training Conference*, Arlington, Virginia, 14-15 June 1966, page 92.

One of our weaknesses in the computer industry — particularly in the software area — is our reluctance to admit that there is a place for the technician. The sooner we face up to this fact, the sooner we will be able to put the professional to work doing the things that only he is qualified to do. Unless we are willing to define and break down the various levels of skills required in the software area, we will continue to waste our scarce professional manpower with routine assignments that could and should be performed by the technician. Obviously some EDP managers have learned this lesson, but we still have a long way to go.

Curriculum

What are the areas in which training should be provided by the good private school? While these are not necessarily in order of importance, I like to consider them as follows:

1. Brief orientation courses for executives and managerial staff. The sole purpose here is to teach these men how to understand and utilize the power of this management tool known as a computer.
2. A series of more technically oriented courses designed to upgrade EDP managers and professional staff in the latest state-of-the-art.
3. Longer and more intensive courses designed to train programmers and problem solvers at the technician level. The input into this type of training program will normally have at least a high school education and in many cases will have from two to four years of college.

Since the third level is the level that most private schools are limited to, let us consider it in more detail.

A good programming course should perhaps begin with a consideration of the business environment in which the graduate may well find himself when his initial training is completed. This will include business and corporate organization, and the functional responsibility of the legal, accounting, marketing, personnel, production, financial and budgeting elements of a business. It will describe the role of planning, forecasting and goals. The overall intent here is to acquaint the trainee at the outset with the terminology and environment of his future place of employment. Unless the trainee takes an active interest in these concepts, he cannot hope to progress as a systems analyst or a problem solver.

After this introduction to business, the next section might well be an overview of the real power of an information handling system such as a modern computer. In the course of this segment, the student should be introduced to information systems as they relate to management and the handling of large volumes of data in an effort to make better management decisions, cut production costs, reduce lead time, schedule purchase of raw materials and supplies, and insure a constant supply of trained manpower.

The next step is one more move away from the general to the specific. In this third phase the student is brought face to face with a more intensive look at the information system that he will later design. He will consider the hardware components necessary to handle an information system and some of the terminology associated with hardware and software elements. He will be introduced to the systems design function where alternatives are determined by a series of trade-offs.

Finally, the student will do the actual work of data processing and programming. There obviously will be many hours spent on business-oriented programming languages and common operating systems.

Based upon my experience in the field of computer training in the private and business sector, I believe curriculum is the key element in a good private computer school.

Staff

But there are other qualities which should also be considered. Some of these are a competent school staff: the school director, the managerial staff, and the instructional staff. Unless the school has quality here from the standpoint of competence, motivation, and ability, the entire curriculum is meaningless. A visit to the school will enable you to evaluate the competence of the staff. A good school will be operated in a professional manner. If it is not, the graduate will have difficulty adjusting to the business world upon graduation.

Facilities

Another factor to consider while you are in the school is the availability of a modern, versatile computer for student use. Far too often, private computer schools use small card-oriented systems for training. These small systems bear increasingly less relationship to what the graduate will find in business applications. Some private schools buy time on systems miles from their installation for training purposes. This too is unsatisfactory as it severely limits the amount of hands-on time available to the student. It is mandatory that each student be given ample opportunity for actual utilization of the computer if he is to be properly trained.

Aptitude Tests

Also, ask the school to let you see the aptitude testing and screening procedure used in the selection of students. Unfortunately, most schools use a version of the IBM Programming Aptitude Test. If a candidate takes the test at several schools, his score will probably improve each time he repeats the test. If you have any doubts about the validity of a school's testing and screening procedure, send a friend to the school as a prospective student and ask him to purposely fail the test. If you are dealing with a quality school, they will counsel the candidate to seek another career.

Another factor to consider in your evaluation of a computer school is location. Quality schools are usually situated in a building and environment which is conducive to good learning. Facilities should be designed to provide optimum instruction rather than optimum profit. Class sizes should average 15 to 20 students. When classes exceed this level the student receives little personal attention and less instruction.

Professionals of the computer industry are in the best position to do something about improving the quality of training now being offered. It is up to them to specify what they want. If they do this, the good schools will respond with the quality of training required now as well as in the years ahead. ■

IBM EQUIPMENT

Sale - Purchase - Lease

All models of computers and unit record equipment available under IBM maintenance.

I-C-E, Inc., 1130 New Hampshire Ave., N.W., Washington, D.C.
20037 / (202) 659-3536

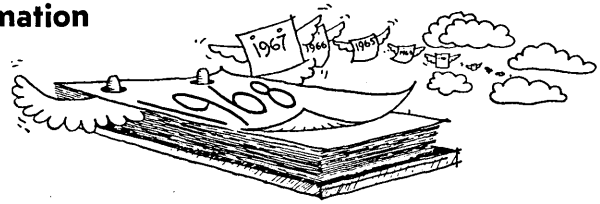

The Flood of Automatic Computers

Reprinted from Vol. 2, No. 7 — October, 1953

Neil Macdonald
Assistant Editor
Computers and Automation

Ten years ago who would have predicted that by 1953 there would be over 100 kinds of automatic computers? and probably well over 1000 of such machines in existence and operating? Almost no one — certainly not such leading pioneers as Dr. Howard H. Aiken of Harvard, Dr. Vannevar Bush of Mass. Inst. of Technology, or Dr. George L. Stibitz then of Bell Telephone Laboratories — would ever have made any such prediction.

What is the extent of this flood of automatic computers, and what are the reasons for it?

Types of Automatic Computers

Elsewhere in the October, 1953 issue is published a list of 107 types of automatic computers, for which the editors of *Computers and Automation* have obtained specific information. But we know that there are a number of types of automatic computers not yet included in this list. Doubtless many types of fire control automatic computers, both general purpose and special purpose, which are under various degrees of military classification, are missing from this list. Automatic computers in foreign countries are probably not as well reported as they could be; in an earlier issue T. Fortuna reported the existence of several automatic computers in the Soviet Union — not yet entered in our list for lack of specific information to date.

Other Computers Being Started

As far as information reaching us reveals the true situation, 1953 is relatively only a beginning. From month to month, more manufacturers apparently say to themselves "Automatic computing equipment — hmm! — looks like a good field to go into, — let's investigate to see if we should enter it." The spirit is infectious. Groups of engineers who have worked together on a computer project within one organization, rather often it seems, secede and go into business for themselves. Some of these new firms grow soundly, but most of them apparently are bought up and become new divisions of larger and stronger organizations.

Resources Invested

To construct an automatic computer is not easy. It takes a considerable amount of engineering effort, and payment of a considerable bill for materials and labor, in order to construct an automatic computer that will do useful work. In fact, it is rather easy to estimate that well over \$100 million, and perhaps over half a billion dollars has been spent in the last ten years towards the construction of automatic computing equipment. Why?

Basically, there are three main facts, two old and one new. First, that information is useful. Second, that interesting, im-

portant, and valuable information can be derived by reasonable processes from other information. And third, that very often machines can automatically perform reasonable processes much faster and much more reliably than human beings ever can.

This last fact was proved beyond the shadow of a doubt by the construction and successful operation of the first highly general and truly automatic computers: 1942, the Mass. Inst. of Technology Differential Analyzer No. 2; and 1944, the Harvard IBM Automatic Sequence Controlled Calculator, Mark I.

This third fact, when known, was the giving away of a vast secret: "it can be done". In the same way, the use of a certain explosive at Hiroshima in August 1945 gave away the vast secret of the atomic bomb; "it can be done". The rest is essentially detail, deciphering the cipher of Nature, knowing that "it can be done". And non-American scientists are likely to think harder than American scientists, because they have fewer resources and must accordingly think harder: witness the British commercial jet planes.

With the knowledge that machinery for automatic handling of information was possible, and in addition the realization that electronic speeds could be employed for this purpose (1946, the Moore School's Eniac), a great many people began to look at information with new eyes. Why rely on "arm-chair" judgments if you could compute? Why rely on the estimates of men with "experience", if you could replace the estimate with something more accurate? Why give up on the problem of shooting down an attacking plane, if you could automatically aim your defending guns?

In fact, what are all the places in our society where "finished" information is wanted, and how can we obtain this information easily by automatic processing of "raw" information?

Realizing the answers to these questions has led to the great tide of resources, funds, scientists, technicians, materials, human attention, interest, and support, and thus the present flood of automatic computers. Probably it resembles in many ways the development of the automobile industry in its early years.

Which Way is the Flood Going?

The automobile business contains many fewer manufacturers and models, though many more cars, nowadays than it did thirty years ago. Is the same trend likely for automatic computers?

It is hard to be certain, but it does seem likely that the same forces will operate. Clearly, many of the types of automatic computers built by university laboratories are one of a kind, and will never be repeated. But the problems of computing information have much more variety to them, it seems, than the problems of transporting human beings and baggage

over a road, and so the number of types of automatic computers is likely to remain relatively high.

Price

As in the automobile business, the cost of computers relative to the cost of other commodities will almost certainly go down — there is plenty of competition to produce that effect — and there are no indications so far that restraints because of patent infringements and lawsuits are likely to be serious.

It is a question whether the price of an automatic computer will go so low that it will be less than the cost of materials to a university laboratory; but this has happened for desk calculators, which no university laboratory dreams of constructing.

Size

In the case of motor cars, there are natural limits to size. A car has to be large enough to hold at least one person; and it has to be small enough to go on a road, under a bridge, and through a tunnel. But with computers, there are hardly any limits to reduction in size, because the marks or

equipment that represent information inside a computer can be made extremely small. There is certainly no advantage in itself to large size and large power requirements. Almost certainly, the most elephantine of automatic computers has already been constructed.

Reliability, Speed, and Capacity

Just as in the development of motor cars, the reliability, speed, and capacity of automatic computers is bound to increase, as a result of discoveries, increased know-how and the force of competition.

It is quite likely also that the distinction between analog and digital computers will largely disappear; one and the same computer will be able to operate in either fashion, choosing according to its own convenience in the problems to be solved. It is also likely that improved interchangeability of parts, and wider intercommunication among computers, will be developed — so that good results obtained in one computing system will be quite easily available (both physically and mentally) in another computing system.

Finally, we can be sure that the number of automatic computers — or more exactly, the number of pieces of equipment capable of handling information automatically — will increase from thousands to millions. ■

C.a

IDEAS: SPOTLIGHT

IBM Technician Has \$75,000 Idea

**IBM Corp.
Armonk, N.Y. 10504**

Huyler Van Buren, a 48-year-old technician at IBM Corp., Kingston, N.Y., has received a \$75,000 award from IBM Corp. for an idea he suggested for a more effective way to repair magnetic core planes in computer memories. His award is believed to be the largest suggestion award ever presented by American industry.

Mr. Van Buren's idea involves the re-working of magnetic core planes used in some IBM computers.

The planes are stacked in arrays to form the memory of a computer. Each plane is made up of thousands of tiny ferromagnetic cores precisely strung on hair-thin wires. Two or three wires pass through each core, and the wires are welded to electrical contacts at the edge of the core plane's frame. The cores retain binary — on or off — information. They are switched from one binary state to another when electrical current flows through the wires in the appropriate direction.

Exhaustive testing of the memory arrays occasionally reveals a defective core plane. The method of removing defective planes from the array frequently damages the plane's frame. Before Mr. Van Buren's suggestion the core plane frequently had to be scrapped even though the cores and wires themselves were not defective.

Mr. Van Buren suggested a method for removing the cores and wires intact from the frames and re-welding them to new frames. Thus, only the faulty frame is scrapped. The core plane itself — the result of precision workmanship — is salvaged.

The new method involves cutting the wires around the edge of the frame without disturbing the cores strung on the wires. The wires are then re-welded on a new frame.

Mr. Van Buren, who marked his 17th anniversary with IBM the day before receiving his award, had previously submitted 47 suggestions via the company program. Seventeen of them were recognized for awards totalling \$752,50. ■

Huyler Van Buren explains the technique that earned him a \$75,000 suggestion award to Mrs. Verna Avery, an assembler, at IBM Corp., Kingston, N.Y.

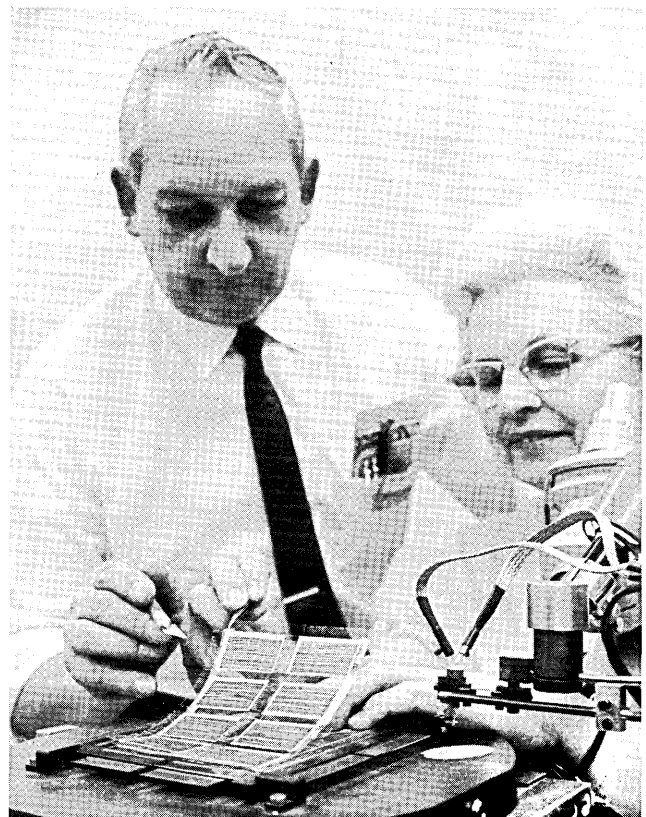

CALENDAR OF COMING EVENTS

- Dec. 9-11, 1968: Fall Joint Computer Conference, Civic Auditorium (Program sessions), Brookshall (industrial and education exhibits), San Francisco Civic Center, San Francisco, Calif.; contact Dr. William H. Davidow, General Chairman, 395 Page Mill Rd., Palo Alto, Calif. 94306
- Dec. 12-13, 1968: Digital Equipment Computer Users Society (DECUS) 1968 Fall Symposium, Jack Tar Hotel, San Francisco, Calif.; contact Angela J. Cossette, Digital Equipment Computer Users Society, Main St., Maynard, Mass. 01754
- Dec. 16-18, 1968: Adaptive Processes Symposium, Univ. of California at L.A., Los Angeles, Calif.; contact J. M. Mendel, Douglas Aircraft Co. Inc., 3000 Ocean Pk. Blvd., Santa Monica, Calif.
- Jan. 15-17, 1969: Second Annual Simulation Symposium, Tampa, Fla.; contact Annual Simulation Symposium, P.O. Box 1155, Tampa, Fla. 33601
- Jan. 24-26, 1969: 75th Annual American Mathematical Society (AMS) Meeting, The Jung Hotel, 1500 Canal St., New Orleans, La. 70141; contact American Mathematical Society, P.O. Box 6248, Providence, R.I. 02904
- Jan. 28-31, 1969: International Symposium on Information Theory, Nevele Country Club, Ellenville, N.Y.; contact David Slepian, Dept. of Transportation, Washington, D.C.
- Jan. 30-31, 1969: Third Annual Computer Science and Statistics Symposium of the Los Angeles Chapter of the Association for Computing Machinery (ACM), International Hotel, Los Angeles, Calif.; contact Business Admn. Extension Seminars, Room 2381, GBA, Univ. of Calif., Los Angeles, Calif. 90024.
- March 21-22, 1969: 7th Annual Atlantic Systems Conference, Americana Hotel, New York, N.Y.; contact Atlantic Systems Conference, P.O. Box 461, Pleasantville, N.Y. 10470
- March 24-26, 1969: 10th VIM meeting, (users group of Control Data 6000 computer series), Florida State University Union, Tallahassee, Fla.; contact Carol J. Richardson, Control Data Corp., 8100 34th Ave. So., Minneapolis, Minn. 55440
- March 24-27, 1969: IEEE International Convention & Exhibition, Coliseum and N.Y. Hilton Hotel, New York, N.Y.; contact IEEE Headquarters, 345 East 47th St., New York, N.Y. 10017
- March 26-29, 1969: 16th International Meeting of The Institute of Management Sciences, Hotel Commodore, New York, N.Y.; contact Granville R. Garguilo, Arthur Anderson & Co., 80 Pine St., New York, N.Y. 10005
- April 1-3, 1969: Numerical Control Society's Sixth Annual Meeting & Technical Conference, Stouffer's Cincinnati Inn, Cincinnati, Ohio; contact Peter Senkiw, Advanced Computer Systems, Inc., 2185 South Dixie Ave., Dayton, Ohio 45409
- April 15-18, 1969: The Institution of Electrical Engineers and the Institution of Electronic and Radio Engineers Computer Aided Design Conference, Southampton University, So 9, 5 NH., Hampshire, England; contact Conference Dept., IEE, Savoy Place, London, W.C.2
- April 23-25, 1969: 21st Annual Southwestern IEEE Conference and Exhibition, San Antonio Convention and Exhibition Center, San Antonio, Texas; contact William E. Cory, Southwest Research Institute, Box 2296, San Antonio, Texas 78206
- May 5-6, 1969: Association For Computing Machinery (ACM) Symposium on Theory of Computing, Marina del Rey Hotel, Marina del Rey, Calif.; contact Prof. Michael A. Harrison, Dept. of Computer Science, Univ. of California, Berkeley, Calif. 94720
- May 6-9, 1969: The Association of Educational Data Systems (AEDS) Annual Convention, Portland Hilton Hotel, Portland, Ore.; contact Wayne J. Smith, Convention Contractor, 201 Massachusetts Ave., N.E., Washington, D.C. 20002
- May 7-9, 1969: International Joint Conference on Artificial Intelligence, Statler-Hilton Hotel, Washington, D.C.; contact Dr. Donald E. Walker, IJCAI Program Chairman, The MITRE Corp., Bedford, Mass. 01730
- May 14-16, 1969: Spring Joint Computer Conference, War Memorial Auditorium, Boston, Mass.; contact American Federation for Information Processing (AFIPS), 345 E. 47th St., New York, N.Y. 10017
- May 18-21, 1969: Power Industry Computer Application Conference, Brown Palace Hotel, Denver, Colorado; contact W. D. Trudgen, General Electric Co., 2255 W. Desert Cove Rd., P.O. Box 2918, Phoenix, Ariz. 85002
- June 8-12, 1969: Sixth Annual Design Automation Workshop, Hotel Carillon, Miami Beach, Fla.; contact Dr. H. Freitag, IBM Watson Research Ctr., P.O. Box 218, Yorktown Heights, N.Y. 10598
- June 9-11, 1969: IEEE International Communications Conference, University of Colorado, Boulder, Colo.; Dr. Martin Nesenbergs, Environmental Science Services Administration, Institute for Telecommunication Sciences, R614, Boulder, Colo. 80302
- June 16-19, 1969: Data Processing Management Association (DPMA) 1969 Internat'l Data Processing Conference and Business Exposition, Montreal, Quebec, Canada; contact Mrs. Margaret Rafferty, DPMA, 505 Busse Hwy., Park Ridge, Ill. 60068
- June 16-21, 1969: Fourth Congress of the International Federation of Automatic Control (IFAC), Warsaw, Poland; contact Organizing Comm. of the 4th IFAC Congress, P.O. Box 903, Czackiego 3/5, Warsaw 1, Poland.
- June 17-19, 1969: IEEE Computer Group Conference, Leamington Hotel, Minneapolis, Minn.; contact Scott Foster, The Sheffield Group, Inc., 1104 Currie Ave., Minneapolis, Minn. 55403
- June 19-20, 1969: Seventh Annual Conference of the Special Interest Group, Computer Personnel Research of the Association of Computing Machinery, Univ. of Chicago, Chicago, Ill.; contact Dr. Charles D. Lothridge, General Electric Co., 570 Lexington Ave., New York, N.Y. 10022
- June 21-28, 1969: Second Conference on Management Science for Transportation, Transportation Center at Northwestern University, 1818 Hinman Ave., Evanston, Ill. 60204; contact Page Townsley, Asst. Dir., Management Programs, 1818 Hinman Ave., Evanston, Ill.
- Aug. 6-8, 1969: Joint Automatic Control Conference, Univ. of Colorado, Boulder, Colorado; contact unknown at this time.
- Aug. 11-15, 1969: Australian Computer Society, Fourth Australian Computer Conference, Adelaide Univ., Adelaide, South Australia; contact Dr. G. W. Hill, Prog. Comm. Chrmn., A.C.C.69, C/-C.S.I.R.O., Computing Science Bldg., Univ. of Adelaide, Adelaide, S. Australia 5000.
- Aug. 25-29, 1969: Datafair 69 Symposium, Manchester, England; contact the British Computer Society, 23 Dorset Sq., London, N.W. 1, England



REPORT FROM GREAT BRITAIN

U.S. Leasing Companies

U.S. leasing organisations are moving as rapidly as they can into the British market. This is not because of our delightful climate but rather reflects a belief that in a market where, traditionally more companies have bought their computers than have rented them, a turning point could soon be reached, particularly when the attractiveness of the longer-term leasing arrangements have been made more widely known.

The most recent group to gain a foothold in Britain is Boothe Computer Corporation. From its new London office it will cover Europe and Canada—mainly with IBM 360 equipment it is anticipated, though the company's London staff has indicated that other manufacturers might be brought in. Strength for the American parent company is an investment of \$100m over the first nine months of 1968. Available for Britain and Europe is between \$75m and \$100m.

Meanwhile the larger Leasco group, established in Britain and ten European centres for about half a year, has moved to take over a British Management consulting group called Inbucon, the only one to be quoted on the London Stock Exchange. The price bid is close on \$10m and completion of the deal will give Leasco an entree into many companies who are just preparing to use a computer.

Leasing was not unknown in the U.K., however, before the advent of these two powerful groups. Computer Resale Brokers (CRB), which began life selling second-hand computers, also has been active in leasing and is understood to have served IBM (UK) well when the latter announced its ten per cent increase on rentals from January 1 (later restricted by Government action to seven per cent for equipment placed before that date). On the day of the announcement, it is understood that several cancellations of IBM equipment would have been decided but for the lower terms available from CRB.

Maintenance on Older Machines

Maybe there is something of a quid pro quo in the arrangement which IBM has made but not announced to educate on its own premises and maintain programmes for users of second-hand IBM machines sold on the open market in Britain. Assistance will also be available in installation planning without charge and without strings. So far as is known IBM is the first and until now the only manufacturer to extend support of this kind in respect of its older machines.

It is a shrewd policy move for it places the British Company in a difficult predicament. So far as IBM is concerned, all it is likely to have to cope with is a handful of the larger commercial machines, the bulk of open market sales being of 1401 and assimilated equipment (most of it handled by Computer Resale Brokers). This means spares and maintenance teams for, say, six machines at the most. But so far as International Computers is concerned the headache of obsolete equipment is a serious one. Just to enumerate what the list contains is enough: Atlas, Orion 1 and 2; Elliott 503 and

803; ICT 1500, 1301, 1302; Emidec 1100, 2400; Univac 1004; English Electric Leo III, 326, 360, KDP8, KDN2, KDF 6 etc. etc. Some of these machines were installed in very few numbers and the problem of keeping together maintenance staff must be quite insuperable.

ICL, the British group, though greatly strengthened by British Government aid, is hardly in a position to say to buyers of one or other machine from the motley crew above either that they will be able to obtain new machines at particularly favourable rates or that the obsolete equipment will be treated as if it were new. Nevertheless if they are to keep the goodwill of users, some of whom are not yet ready to switch into new ICL machines and have been expanding computing power by adding older second-hand equipment to similar units which they have operated for two or three years now, they will have to come to some arrangement which need not be the blanket cover provided by IBM but could be some ad hoc system ensuring that important potential clients are not alienated by difficulties on maintenance and certification. This is particularly important at the moment since during the next year probably one-hundred of the 1900 series machines will come on to the secondhand market, which is almost the sole source of supply of the smaller educational institutions with restricted budgets.

It is imperative to make a good impression on budding analysts, programmers and industrial leaders, otherwise ICL may see its future markets dry up simply for want of a little salesmanship. IBM has understood from the first that a satisfied client with an obsolete machine is fertile ground for an IBM salesman with a brand-new product.

ICT and English Electric Service Bureaus Combine

Meanwhile ICL has solved one of the problems consequent on the merger which gave it being—the joining together of the bureau activities of ICT and English Electric. It has formed the largest bureau group in Britain under the name of International Computing Services with 18 computers in 14 offices and the services of 800 trained staff.

The new company has something like 2,000 regular clients and can claim the lead in the UK market with a yearly turnover estimated at over \$7m compared with a total market of around \$27m. It is an independent company in the ICL group and seems set for a brilliant future since bureau business has been growing at a rate of 50 per cent annually in the last four years. Moreover there are plans afoot to move into various European countries, with France the first target. ■

Ted Schoeters
Ted Schoeters
Stanmore, Middlesex
England

ACROSS THE EDITOR'S DESK

Computing and Data Processing Newsletter

Table of Contents

APPLICATIONS

Safety Council Computer Analyzes Accident Data and Identifies Accident Patterns	57
Toys Linked to a Computer Aid Research Work of Georgia State Psychologists	57
PDP-8/S Computers Control Delivery of 200M Barrels Per Year of Crude Oil	57
Control Program for Communicable Diseases Uses Computerized System	58
Allegheny Health Department Monitoring Air Pollution With On-Line System	58
Crop Production Studies Helping Determine Best Environment Conditions for Maximum Yields	58

EDUCATION NEWS

Boston Latin — Country's Oldest School — Uses New Computer	59
North Carolina Universities Arrange Cooperative Educational Computer Facility	59
Control Data Institute Offers New Approach to Programming Instruction for Computerless Schools in N.E.	59

COMPUTER RELATED SERVICES

Low Cost Computerized Marketing Service for Manufacturers	59
Computerized Accounting Service for Mortgage Banks and Mortgage Loan Companies	59

TIME-SHARING SERVICES

No. Carolina Insurance Firm Offers On-Line Service for Savings & Loan Associations	60
GE's Largest Commercial Time-Sharing Facility Opens in California	60
Marquardt Corp. Has Entered Computer Time-Sharing Field	60

SOFTWARE

ARBITRAGE I — Parsons & Williams	60
COMPUTER ASSISTED ROUTE DEVELOPMENT (CARD) SYSTEM — A. T. Kearney & Company, Inc.	60
CONTRACT COST CONTROL SYSTEM — Delta Data Systems	60
COSMOS (Computer Optimization and Simulation Modeling for Operating Supermarkets) — The National Cash Register Co.	61
FLIRT (Fortran Logical Information Retrieval Technique) — Economatics	61
KEYPUNCH PERFORMANCE SYSTEM — Lutter and Helstrom, Inc.	61
REMOTE JOB ENTRY (RJE) PROGRAMS — IBM Corporation	61

RESEARCH FRONTIER

Remote-Controlled Manipulators Studied for Use in Building, Repairing, Maintaining Satellites in Space	61
--	----

NEW LITERATURE

System Interaction Corp. Offers "Software Packages, an Encyclopedic Guide"	62
ICP Quarterly Catalog of Computer Programs Adds Three New Sections	62

ORGANIZATION NEWS

IBM Withdraws Previously Announced Charge Adjustments for Maintaining DP Equipment Systems and Procedures Association Changes Name, Adopts New Constitution and By-Laws	62
Singer-General Precision Inc. is New Name for General Precision Systems Inc.	62

AS WE GO TO PRESS

63

APPLICATIONS

SAFETY COUNCIL COMPUTER ANALYZES ACCIDENT DATA AND IDENTIFIES ACCIDENT PATTERNS

The National Safety Council, Chicago, Ill., has added a computer to its continuing battle against the nation's fourth-ranking killer, accidents. An IBM Model 1130 will process accident data of all kinds to define patterns, indicate probable relationships, and isolate out-of-norm situations in groups of accidents. The composite photo below, symbolizing NSC's new computerized accident data analysis program, shows an IBM punch card superimposed over a time exposure of traffic at the Edens and Kennedy expressways in Chicago. In the NSC program, accident reports on punch cards are fed into the computer's magnetic-disc memory for analysis.

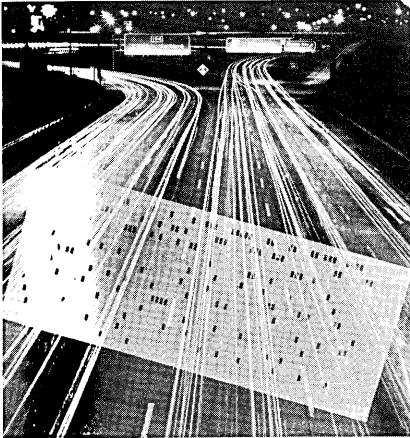

Beyond the usual statistics methods commonly used with computers, the NSC staff has developed a new probing technique it calls "tree search" (for the way it identifies good leads branching off from the primary search pattern). The computer and its new program allow for accident analysis according to any combination of up to 20 variables at a time. With motor-vehicle accidents, for example, they include such characteristics as sex, age, and physical condition of drivers involved; type of accident and condition of roadway; day of the week and hour of the day of the accident; weather conditions; and even the manner of collision.

In response to the tree-search program, a previously unrecognized pattern has been discovered that may lead researchers to new measures against traffic accidents. It has been found that accident types involving drinking drivers apparently differ in character from those involving the general driving population. Drinking drivers had fewer

angle crashes — like those that might take place at an intersection — and more 'in-line' accidents with cars just ahead or cars approaching them than would be expected. Even with the patterns and relationships of accidents disclosed, however, there is still the task of developing answers and putting solutions to work.

Analysis with the computer holds promise not just for traffic, but for all areas of accident prevention. Statisticians already are studying problems in farm, home, boating, pedestrian, and bicycle safety. With better understanding of factors that lead to accidents, we may hope for the development of more effective remedies.

TOYS LINKED TO A COMPUTER AID RESEARCH WORK OF GEORGIA STATE PSYCHOLOGISTS

Several children are having fun in the interest of science at Georgia State College, Atlanta, Ga., by playing games with toys linked to a computer. The experiment, involving maladjusted children ranging from seven to twelve years of age, combines modern data processing techniques and old-fashioned therapy.

In a play area resembling a penny arcade, the children are allowed to choose between aggressive toys such as guns and constructive toys such as a shuffle bowling machine while the computer automatically monitors the play through sensors linked to the toys.

To conduct its experiments, the Georgia State psychology department is using facilities of the college's Computer Center, including an IBM 1800 data acquisition and control system, a computer not usually associated with educational research. The 1800 was selected — rather than a standard commercial computer — because it can be linked directly to sensors. The sensors register whenever a toy is used.

Dr. Earl Brown, head of the Georgia State psychology department, said the equipment makes it possible to run lengthy, controlled experiments under a variety of conditions with data available immediately for analysis. "Previously," he said, "psychologists have been limited to short-term experiments which produced enormous amounts of material to study... Many times the researcher in such a study could never arrive at a satisfactory answer."

Dr. Brown feels that studies this fall may lead to new forms of psychological research. "The fu-

ture is wide open," he said. "The computer itself will challenge us to be ingenious in its use. There are many possibilities, perhaps such a thing as computer-assisted psychological testing...."

PDP-8/S COMPUTERS CONTROL DELIVERY OF 200M BARRELS PER YEAR OF CRUDE OIL

Deliveries in excess of 200 million barrels per year of crude oil through one of the largest such pipelines in the Western Hemisphere has become more economical and efficient with the completion of a computerization program by Interprovincial Pipe Line Company and its subsidiary, Lakehead Pipe Line Company, Superior, Wis.

All 32 pumping stations along an 1100 mile segment (Edmonton to Superior) of the 2,000 mile line have been placed under the control of 20 Digital Equipment Corporation PDP-8/S computers. Two additional PDP-8/S computers are installed in Superior and Sarnia, Ontario for data acquisition from 30 more pumping stations along the balance of the line which extends to Port Credit, Ontario. The 22 remote computers automatically monitor and/or control the pumping stations and perform all data acquisition, interpretation, and transmission functions.

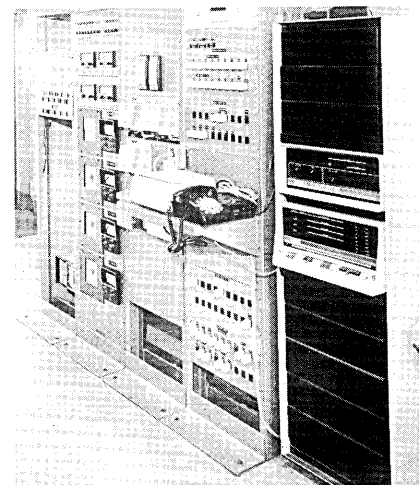

— A typical remote computer-controlled pumping station. The PDP-8/S computer (right) controls and monitors the associated relay rack through which all computer signals are generated.

The remote computers are controlling both diesel and electric pumping stations, and in some cases, without the presence of an operator on the premises. Each computer must handle three separate pipe lines through each pumping location, three separate pumping sta-

tions at each location, and up to a total of thirteen pumping units per location. A number of safety checks are also computer-generated.

Each of these remote computers is connected on-line to two more PDP-8/S systems and an IBM System/360 Model 40 located in the central computer complex at the Edmonton headquarters of Interprovincial. In the Edmonton center, the PDP-8/S computers control communications, and the IBM System/360 stores and processes the data. All commands from the central control system in Edmonton are subjected to two passes before being executed. On the first pass an operational command is checked to determine (a) whether it is valid and (b) whether it is reasonable. If valid and reasonable, the command is executed on the second pass.

CONTROL PROGRAM FOR COMMUNICABLE DISEASES USES COMPUTERIZED SYSTEM

The Medical College of Georgia and the National Cash Register Company have developed a computerized system which can be used in the control program for communicable diseases in state-wide or county-wide areas. The system is designed to keep track of long-term patients as well as all persons who have had exposure to the communicable disease but who are not ill. The system has been tested in tuberculosis control and is presently in operation in Richmond County, Georgia, and Aiken County, South Carolina. Records are now being abstracted for the inclusion of patients in other nearby counties.

Under the system, persons identified by a doctor, clinic or other source as having had contact with tuberculosis and all persons having the disease are registered. A standard form for computer input is used and treatment histories are included. Every week, the computer prepares lists of new cases and reports of contact, broken down by locality. The listings are sent to field investigators, public health nurses and others responsible for locating and investigating new cases. Letters and reminders to patients and people who have had contact with the disease are automatically prepared by the computer advising them of scheduled examinations. It also makes up examination schedules for the various treatment centers.

The project, under the direction of Dr. Rufus F. Payne of the Medical College's Division of Hospital Research and Development, required two man-years of programming effort and has been written for the NCR 315 computer. The programs are

available to any public health agency having access to an NCR 315 system with at least 10,000 characters of main memory and four tape handlers.

ALLEGHENY HEALTH DEPARTMENT MONITORING AIR POLLUTION WITH ON-LINE SYSTEM

The heavily industrial area of Pittsburgh, Pa., has taken a giant stride toward the control of pollutants with implementation of a county-wide network of telemetering stations hooked directly to an IBM 1800 data acquisition and control system. The network will provide the Allegheny County Health Department with up-to-the minute information on levels of pollution at any point in the county at any time. This, in turn, will allow the department's bureau of air pollution control ample time to advise residents of potentially dangerous situations, and to recommend effective countermeasures.

The system is designed to measure and evaluate 12 aspects of air pollution and meteorology, including sulfur dioxide, hydrogen sulfide, carbon monoxide, hydrocarbons, aldehydes, fine particulates, wind speed and direction, air temperature, solar radiation, oxides of nitrogen and total oxidants. When fully operational within two years, the computer-based network will be comprised of 103 continuous-monitoring sensor devices (shown below) at 18 remote locations. Each station will be directly linked by telephone lines to the IBM 1800 at the Arsenal Health Center in Pittsburgh.

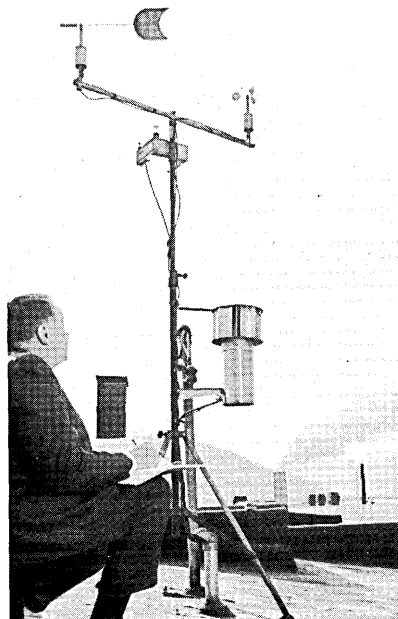

— Edward L. Stockton, chief of the County Bureau of Air Pollution Control, is shown inspecting a sensing device.

Air pollutants entering the sensing instruments are analyzed, and the readings are transmitted as electrical signals over the telephone lines to the computer. The 1800 isolates and prints out maximum readings from each remote location. It then averages readings a minimum of once per minute, thus giving the average condition over any specified period. Total findings are printed out in engineering units, to be interpreted by the bureau staff.

Two of the stations are now operating and seven more are scheduled to go into service within the first quarter of the coming year.

CROP PRODUCTION STUDIES HELPING DETERMINE BEST ENVIRONMENTAL CONDITIONS FOR MAXIMUM YIELDS

An unusual cornfield and an IBM computer may help answer one of farming's oldest problems: What are the best environmental conditions for maximum crop yields? A one-acre field, located on a John Deere experimental farm in Coal Valley, Ill., is planted with several types of corn spaced at varying intervals and in rows varying distances apart. Sensing devices mounted on poles in the field monitor the sunlight, wind, moisture and temperature in the plant cover and transmit the data to recording equipment in a nearby trailer. This equipment punches the information into a tape which is "read" into an IBM 1130 computer.

Deere & Company researchers are using this computer stored data to construct a mathematical model of the field based on information gathered during the last three growing seasons. The model will be used to simulate actual conditions in a cornfield during a growing season.

Dr. William C. Burrows, a Deere agronomist explained, "With the computer and its mathematical cornfield, we can introduce variables that will affect the plants such as changes in weather conditions... The computer will provide answers in hours that otherwise would take months or years."

One of the most important questions the researchers will try to answer is what is the optimum spacing of plants. Finding the correct answer will make it possible to achieve maximum yields per acre and help provide maximum output for the world's growing population, Dr. Burrows said. Other questions the researchers hope to answer include the maximum number of plants possible in a field, the best seeding

rate, yield rates of various types of corn and the effects of weather on crops. Dr. Burrows said scientists were using corn for their study because of its importance as a crop and because its reactions to changing conditions are similar to the reactions of other crops.

EDUCATION NEWS

BOSTON LATIN — COUNTRY'S OLDEST SCHOOL — USES NEW COMPUTER

Boston Latin, the oldest school in the United States, founded in Boston, Mass., 141 years before the Declaration of Independence, is using one of the most modern teaching tools — the electronic computer. Dr. Wilfred O'Leary, head master, disclosed that his school has installed an IBM 1130 computing system.

The compact, desk-sized computer is used to teach programming to 300 juniors and seniors. The

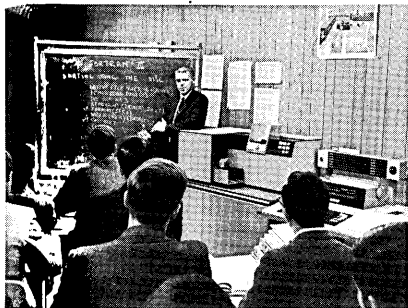

computer also is used in "open shop" sessions in which students undertake projects of their own choosing. Dr. O'Leary said the IBM 1130 is used for "purely intellectual purposes" and that routine accounting, class scheduling and the like are done on another computer belonging to the Boston School Department.

Boston Latin School, which first opened its doors in 1635 and numbers Ben Franklin among its alumni, is an all-male school with an enrollment of 2100. It emphasizes the classical disciplines — Latin and Greek — and places all of its graduates in college.

NORTH CAROLINA UNIVERSITIES ARRANGE COOPERATIVE EDUCATIONAL COMPUTER FACILITY

Students, faculty and researchers at 38 North Carolina colleges and universities are transmitting and receiving answers to thousands

of problems daily from a computer complex at Triangle Universities Computation Center (TUCC) in Research Triangle Park, N.C. The large central computer, an IBM System/360 Model 75, is linked directly to remote tele-processing terminals on each campus — from about 10 to 300 miles away — through telephone line connections.

Established jointly by Duke, North Carolina and North Carolina State Universities, TUCC and its growing state-wide network is believed to be the first cooperative educational computer facility to handle remote computing on such a large scale. Supported in part by a National Science Foundation grant, computing service and technical assistance is offered to over 100 eligible institutions of higher learning.

The bulk of the workload comes from Duke, UNC and NC-State, relayed to TUCC from smaller scale computers on each campus. Capable of simultaneously accepting entries from a wide variety of terminals, the Model 75 "stacks" incoming jobs in intermediate storage devices. Automatically "calling" jobs out of this storage queue, it processes several jobs simultaneously and often groups several jobs together and processes them in a single batch operation. Answers are stacked in intermediate storage devices and automatically transmitted back to the proper terminal as soon as its line is free. The Model 75 processes a large percentage of problems in its job stream in seconds and sends solutions back over communications lines within minutes.

CONTROL DATA INSTITUTE OFFERS NEW APPROACH TO PROGRAMMING INSTRUCTION FOR COMPUTERLESS SCHOOLS IN N.E.

Control Data Institute, Burlington, Mass., has devised a simplified and inexpensive method of computer training for high school students. Known as SCUP (School Computer Use Plan), this new approach to programming instruction for computerless schools offers New England high school students the advantage of a new method of learning computer principles and operation. It also gives teachers the opportunity to upgrade their mathematics curriculum.

The uniqueness of this program is that the schools need no computer equipment. Teachers are provided a set of instructions, the students have their own kits of programming cards and Control Data Institute (the educational division of Control Data Corporation) runs

the program through its 3000 Series computer system, with 24-hour service.

The format of the courses are such that the students are able to write programs at the first class meeting. Two of the courses offered (orientation and competence) use the FORTRAN language. A third course is built around COBOL.

If a teacher wants a student to become more competent in programming, a more sophisticated kit is provided. The kits are arranged to fit the goals and philosophy of the teacher. Prior to teaching the courses, teachers are given a free, three-day orientation session by Dr. Robert E. Smith, educational research staff consultant for the Institute, and other members of the CDI staff. Dr. Smith is the creator of SCUP and the author of its textbooks.

(For more information, designate #31 on the Reader Service Card.)

COMPUTER RELATED SERVICES

LOW COST COMPUTERIZED MARKETING SERVICE FOR MANUFACTURERS

A newly developed, low cost computerized marketing service for manufacturers of over 200 industrial products (including textile, paper, wood, rubber, plastic, chemical, glass and metal) is available from Economic Information Systems, New York. The EIS input-output data bank can pinpoint the location of all potential buying plants for a company's products, thus permitting efficient concentration of marketing, sales and advertising efforts.

Information furnished for each buying plant includes geographical location, 4-digit SIC and amount of the product consumed. Data may be organized by states, counties or zip code areas, and supplied to the user as punched cards or computer print-outs.

(For more information, designate #32 on the Reader Service Card.)

COMPUTERIZED ACCOUNTING SERVICE FOR MORTGAGE BANKS AND MORTGAGE LOAN COMPANIES

University Computing Company, Dallas, Tex., is now offering a new computerized accounting service to mortgage banks and mortgage loan companies. The service employs the MARC II (Mortgage Account Report Compiler) programming system

and the Honeywell 200 computer. MARC II was developed by Mortgage Systems Company, a subsidiary of University Computing Company.

The MARC II package has been designed to meet all the standard accounting needs of mortgage loan bankers but also is flexible enough to accommodate any specialized requirements. The software package is a combination of some 50 special routines written for the Honeywell 200.

MARC II service is available at all Computer Utility and Data Link Division centers of University Computing Company. (For more information, designate #33 on the Reader Service Card.)

TIME-SHARING SERVICES

NO. CAROLINA INSURANCE FIRM OFFERS ON-LINE SERVICE FOR SAVINGS & LOAN ASSOCIATIONS

Security Life and Trust Company, Winston-Salem, N.C. will enter the computer time sharing field with an on-line service developed for savings and loan associations across a 20-state area. Security's operations are planned to begin early next year. The company is in the process of forming a management holding company to permit its entry into areas of service which are not permissible under its present charter.

Security's on-line service would be the first area-wide system originating between Jacksonville, Fla., and Baltimore, Md. It would eliminate practically all of the routine work of savings and loan tellers making customer passbook transactions via teller terminals, plus performing many of the association's accounting functions.

Security's system is unique in that tellers can request a customer's record from the computer using only his name. This ability was developed by Security nearly a year ago for its own customer services through the use of direct access mass storage devices.

The new service will be supported by the company's Information Services Department, at first using one of Security's third-generation computers. Later, in 1969, a new computer will be added for use solely for "on-line" services.

GE'S LARGEST COMMERCIAL TIME-SHARING FACILITY OPENS IN CALIFORNIA

A new \$10-million computer complex has been opened by General Electric Company to provide expanded services to western customers. The 13,200 square-foot center, located in Inglewood, Calif., is considered to be the biggest facility of its kind exclusively for commercial time-sharing.

The center is equipped with five large-scale GE systems — four GE-200 series systems, and a \$3-million GE-600 series system capable of providing advanced Mark II Service to hundreds of simultaneous users throughout the west. Additional systems are scheduled to be installed by the end of this year, as well as in a planned 11,000 square-foot expansion due for completion next year.

Subscribers in the west are now able to obtain immediate use of the systems by dialing the appropriate telephone numbers from their office terminals. Charges are based on the amount of actual useage the customer has on either or both of the two systems and can be as low as \$200 per month for terminal and computer time, and teletypewriter service from the subscriber's local telephone company.

GE's worldwide operation now has more than 50 time-sharing systems installed, providing services to 100,000 users in the United States, Canada, Europe and Australia.

MARQUARDT CORP. HAS ENTERED COMPUTER TIME-SHARING FIELD

The Marquardt Corporation (a subsidiary of CCI Marquardt), Van Nuys, Calif., has entered the computer time-sharing field. The new service makes available a system of telephone ties to Marquardt's computer bank at the Van Nuys facilities, the use of a new and simplified computer time-sharing system, and the availability of preset programs from a reservoir of Marquardt-developed scientific, engineering, and administrative packages.

The nucleus of the Marquardt time-sharing service is the new APL ("A Programming Language") conversational time-sharing system. APL is a mathematical programming language which operates on the IBM System/360 Model 50. With no previous computer experience, an individual can learn and adapt the APL system to his specific requirements within a relatively short instruction period, according to J.D. Wethe, president of Marquardt.

SOFTWARE

ARBITRAGE I / Parsons & Williams, Copenhagen V., Denmark / The system is designed to rapidly determine for a given purpose the optimal set of foreign exchange transactions; it optimizes the arbitrage activities within a given set of currency exchange rates and exchange limits. The program requires a minimum of input data in a simple form. ARBITRAGE I generates a list of optimal transactions together with the corresponding account balances and profit. The system may be used both for activities on the spot and forward market. ARBITRAGE I can be custom-designed to the user's own system requirements. (For more information, designate #34 on the Reader Service Card.)

COMPUTER ASSISTED ROUTE DEVELOPMENT (CARD) SYSTEM / A. T. Kearney & Company, Inc., Chicago, Ill. /

Cost reductions in most local delivery operations are available through application of the CARD System. The system consists of three computer programs: (1) the ROAD Program which defines an abstract, computer "map" or network of the delivery area; (2) the PLOT Program which locates the truck terminal or plant within the delivery network; and (3) the ROUTE Program which accepts customer input data and develops full, fair and efficient routes for each driver. The CARD system accommodates up to 16,000 customers, serviced on any frequency basis from once a day to once a month; 100 different truck routes each day; 10 different types of product; and 20 different truck capacities. (For more information, designate #35 on the Reader Service Card.)

CONTRACT COST CONTROL SYSTEM /

Delta Data Systems, College Park, Md. / Designed for operation on an IBM 360 system, the Cost Control System can be adapted for use in almost any contract environment. The system provides an up-to-date analysis of each active contract. This information, together with all the contract budget data, allows management to supervise each active project from its inception to completion. The progress of each project is analyzed on a current, cumulative, and projected cost basis. (For more information, designate #36 on the Reader Service Card.)

COSMOS (Computer Optimization and Simulation Modeling for Operating Supermarkets) / The National Cash Register Co., Dayton, Ohio / The main objective of the COSMOS system is to increase food store profitability. It is designed to build up a file of information so that a computer can recommend management decisions according to the profit contributions of each item. COSMOS, undergoing pilot testing, is planned for release to the food industry by late 1969. The NAFC (National Association of Food Chains) programs are written in a universal computer language so that they can be run on most computer systems.
(For more information, designate #37 on the Reader Service Card.)

FLIRT (Fortran Logical Information Retrieval Technique) / Economatics, Pasadena, Calif. / Data entered only once in a computer can now be cross-referenced any number of ways using this new program. Designed for use with the IBM System/360 or any other third generation computer, FLIRT is particularly useful for correspondence, memoranda, and other miscellaneous filing within an office or department. FLIRT comes in the form of a Fortran IV deck and is available for \$4,000. Price includes installation and a program demonstration.
(For more information, designate #38 on the Reader Service Card.)

KEYPUNCH PERFORMANCE SYSTEM / Lutter and Helstrom, Inc., Chicago, Ill. / A system for measuring keypunch and verification operator performance and improving keypunching output, the Keypunch Performance System, measures the weekly work performance for each operator's keypunching and verification operations against standards for an organization's entire keypunch department. Standards are based on historical strokes per job, and are subject to regular review and refinement. The software package includes the computer program and supporting elements, indoctrination and program installation assistance, and an updating service. The system can be operated on the client's computers, or through the service department of Lutter & Helstrom.
(For more information, designate #39 on the Reader Service Card.)

REMOTE JOB ENTRY (RJE) PROGRAMS / IBM Corporation, White Plains, N.Y. / New RJE programs are available that allow stations in a remote job entry network to operate with a multiprogrammed System/360. The RJE programs permit remote stations to communicate with a central computer via IBM 2780

data transmission terminals and IBM 1130 computing systems or System/360s operating as terminals. A System/360 Model 50 or larger with 512,000 bytes of core storage is required as the main processor. It operates under Multiprogramming with a Variable number of Tasks (MVT). RJE programming for Model 25s or larger is available now; support for the Model 20 as a terminal is scheduled to be available in the third quarter of 1969.
(For more information, designate #40 on the Reader Service Card.)

RESEARCH FRONTIER

REMOTE-CONTROLLED MANIPULATORS STUDIED FOR USE IN BUILDING, REPAIRING, MAINTAINING SATELLITES IN SPACE

A recent study conducted by engineers at the General Electric Company, Schenectady, N.Y., indicates that remote-controlled manipulators could be used to construct satellites in space — or even to repair or maintain satellites in orbit. The GE effort — performed under a contract from the U.S. Air Force Aero-Propulsion Laboratory at Wright Patterson Air Force Base — has established the preliminary specifications for a system that would permit operators to perform sophisticated construction and repair tasks in space with remote-controlled manipulators. The operators could be located on the ground or in neighboring spacecraft.

The study indicates that a space manipulator system — equipped with TV cameras that would act as "eyes" for the operators — could be mounted aboard a maneuverable "repair spacecraft." Unlike conventional robots, the slave manipulators would incorporate "force feedback," so that an operator could feel what the manipulators are doing. Under this system, an operator's hand and arm movements would be transmitted by telemetry to the repair satellite's slave manipulators, which would mimic the operator's motions. Proportions of the forces generated or encountered by the machine would be transmitted back to the operator's hands, providing him with an accurate sense of touch necessary to perform delicate, complex tasks by remote control.

As a result of this and earlier studies, Richard H. Blackmer, project manager for the GE studies,

has defined a specific configuration for an "android" (man-like) manipulator system for work in

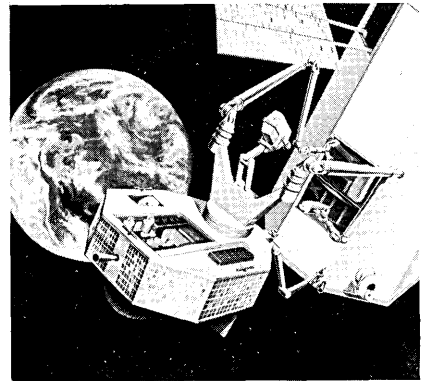

— In this artist's concept, electronic components are installed in an orbiting scientific satellite by slave manipulators mounted aboard a remote-controlled "repair spacecraft."

space. The system would consist of two master-slave arms and hands, a telemetry control system, and a coordinated television viewing system mounted on a remote-controlled, maneuverable satellite equipped with an array of tools and spare parts.

RCC

RANDOLPH COMPUTER CORPORATION

Pan-Am Building
New York, N. Y. 10017

**Offering
Short Term
Operating Leases for
IBM 360 Equipment
Through
Randolph Equipment
Corporation
and
A Complete Range of
Data Processing Services
Through
Randolph Data Services, Inc.
(United Data Processing Divisions)**

The year-long study has shown that the use of manipulators for orbital missions already is technically feasible. It estimated that electric master-slave manipulators — for space applications — could be developed in about five years. One of the most valuable applications of space manipulators, suggested by the study, would be in extending the useful life of many satellites now orbiting the earth, particularly those satellites in synchronous (stationary) orbit. Many of these satellites already are valuable links in the nation's communications and weather forecasting networks. By 1980, as many as 130 satellites may be orbiting the earth in this synchronous "belt."

NEW LITERATURE

SYSTEM INTERACTION CORP. OFFERS "SOFTWARE PACKAGES, AN ENCYCLOPEDIA GUIDE"

A single-source presentation of the over 150 third-generation software packages now on the market, is available from System Interaction Corp., New York, N.Y. Complete specifications are cross-referenced by Industry, Application and Hardware System. "Evaluation Guidelines for Selection and Purchase" are included plus vendor information.

Technical specifications cover: Configuration — hardware supported, equipment required, physical IOCS, special features, I/O variables; Operating Environment — file organization, source language, supervisor, number of discrete steps, number of programs; and General — cost, documentation, purchasing conditions, vendor support.

Updates, published quarterly, will provide continuing coverage of new packages and are easily added to the hardcover ring binder. The Guide, over 200 pages, will be published January 1, 1969. (For more information, designate #30 on the Reader Service Card.)

ICP QUARTERLY CATALOG OF COMPUTER PROGRAMS ADDS THREE NEW SECTIONS

International Computer Programs, Inc., Indianapolis, Ind., has announced that three new sections are being added to its publication, ICP Quarterly. The new sections include (1) a hardware index; (2) a roster of contract pro-

gramming houses; and (3) an index of time-share computer installations.

ICP Quarterly, first published in 1966, is a periodical devoted exclusively to computer software. Its October issue listed nearly 800 computer programs available for sale, lease or franchise. (For more information, designate #29 on the Reader Service Card.)

ORGANIZATION NEWS

IBM WITHDRAWS PREVIOUSLY ANNOUNCED CHARGE ADJUSTMENTS FOR MAINTAINING DP EQUIPMENT

IBM Corporation, White Plains, N.Y., has withdrawn the maintenance service charge adjustments on data processing equipment that were announced in mid-October. The company explained the reason the adjustments were being withdrawn is that some leasing companies have now reported that they have fixed price contractual agreements with some of their customers, and that the fixed prices include maintenance service provided by the IBM Company.

These leasing companies made these arrangements despite the fact that IBM's maintenance agreements, like most contracts subject to inflationary trends, clearly specify that IBM's maintenance prices are subject to change upon three months advance notice.

Since the terms of leasing company contracts are a business matter between them and their customers, IBM could not be aware of the terms of the leasing companies' individual contracts with their customers.

SYSTEMS AND PROCEDURES ASSOCIATION CHANGES NAME, ADOPTS NEW CONSTITUTION AND BY-LAWS

The Systems and Procedures Association has announced the adoption of a new Constitution and By-Laws calling for many changes in its organizational structure, including a name change to "Association for Systems Management." SPA's Division Directors, representing each of its 110 Chapters, voted overwhelmingly to adopt the proposals based on a management study and recommendations of the Association's Long-Range Planning Committee.

The new By-Laws provide for establishment of technical depart-

ments and affiliated sections, increased publications, technical library facilities, systems training and educational programs, student recruitment programs and a complete program of field services. As part of the increased emphasis on publications, the Association's present bi-monthly magazine — the Systems and Procedures Journal — will become a monthly, effective January, 1969.

SPA's 110 Chapters are now divided into 13 Divisions, each of which elects a representative to the International Board of Directors. The new structure provides for 15 International Directors, three each from five new regions. Five of the 15 Directors, one from each region, will be elected annually for three-year terms instead of the present one-year term of office.

The program calls for an enlarged Headquarters staff to carry on the additional activities. Four new executive positions — Director of Education, Technical Director, Field Service Director and Publications Director — will be created.

International President Allen M. Motter of Jones and Laughlin Steel Corp., Pittsburg, Pa., said the new name of "Association for Systems Management" was chosen to give the broad role of systems its proper perspective and to emphasize its position as a management and executive function.

SINGER-GENERAL PRECISION INC. IS NEW NAME FOR GENERAL PRECISION SYSTEMS INC.

The General Precision Systems Inc. name has been changed to Singer-General Precision, Inc. This move follows the merger of General Precision Equipment Corporation into The Singer Company on July 11 of this year.

Singer-General Precision, Inc. will be moving its executive offices from Tarrytown, N.Y. to Singer's corporate headquarters at 30 Rockefeller Plaza, New York City, at the end of the year.

Singer-General Precision, Inc. includes the operations of the Kearfott, Link, Librascope, and Tele-Signal groups which produce advanced systems and components for the government and aerospace industry. Each of these groups will continue to operate in its present plant and headquarters locations.

FINANCIAL AND BUSINESS NEWS

Box Score of Sales & Income for Computer Field Firms

C&A presents below comparative operating results for firms of interest to computer people, as distilled from the latest group of news releases.

COMPANY	PERIOD	SALES		NET INCOME		NOTES
		Current Period Previous Period	(%)	Current Period Previous Period	(%)	
Applied Dynamics, Inc., Ann Arbor, Mich.	Year ended June 30, 1968	\$6,464,000 \$3,653,000	(+70%)	\$178,186 \$55,571	(+300%)	
Automation Sciences, Inc., Jersey City, N.J.	Year ended July 31, 1968	\$1,718,883 \$1,350,901	(+27%)	\$197,219 \$106,497	(+85%)	
Beckman Instruments, Inc., Fullerton, Calif.	Year ended June 30, 1968	\$130,316 \$129,854	(+3%)	\$4,156 \$6,088	(-32%)	Reduced earnings reflect cutbacks in government-supported research programs
California Computer Products, Inc., Anaheim, Calif.	Year ended June 30, 1968	\$16,648,000 \$11,318,000	(+47%)	\$1,210,000 \$1,156,000	(+5%)	Sales for fiscal 1968 below initial goals due in part to government spending policies
Datatron, Inc., Santa Ana, Calif.	Year ended June 30, 1968	\$736,370		\$29,133		After only 13½ months of operations, company "anticipates, at the minimum, to double sales in 1969"
Datronic Rental Corporation, Chicago, Ill.	Year ended June 30, 1968	\$1,425,589 \$388,363	(+265%)	\$173,656 \$70,155	(+149%)	
Information International, Inc., Cambridge, Mass.	Year ended April 30, 1968	\$1,657,433 \$1,700,746	(-3%)	\$183,498 \$94,164	(+94%)	
Mohawk Data Sciences Corp., Herkimer, N.Y.	Year ended July 31, 1968	\$53,600,000 \$27,600,000	(+94%)	\$3,050,000 \$1,370,000	(+123%)	
Northrop Corp., Beverly Hills, Calif.	Year ended July 31, 1968	\$486,838,213 \$470,706,838	(+3.4%)	\$15,740,235 \$12,567,646	(+25.2%)	
Sanders Associates, Inc., Nashua, N.H.	Year ended July 31, 1968	\$193,300,000 \$139,300,000	(+39%)	\$6,180,000 \$4,710,000	(+31%)	
Systems Engineering Laboratories, Ft. Lauderdale, Fla.	Year ended June 28, 1968	\$12,032,000 \$8,027,000	(+50%)	\$1,002,000 \$304,000	(+230%)	Computer products accounted for 72% of sales, compared with 65% in 1967 and zero percent in 1965.

AS WE GO TO PRESS

REPEATED WARNINGS THAT SOMETHING MUST BE DONE TO CURB IMPROPER USES OF THE POWER OF THE COMPUTER were heard at the 1968 MIT alumni seminar on "Computers in the Service of Society" held recently at MIT. Prof. Carroll L. Wilson of MIT's Sloan School called for the creation of a university-based computer development board to provide guidance for government policy and to act as a check against the "threat of premature, unwise, and technologically blind government control of the use of computers".

Dr. Robert M. Fano, Ford professor of engineering at MIT and the first director of Project MAC, cited a danger in people delegating to the computer responsibilities which should be theirs. "The invasion of privacy by computers has gone very far, and we must pay attention to finding ways to protect privacy," he said. "We can always pull the plug on the computer, but we may reach the point where society could collapse if we did."

Dr. Jerome Wiesner, provost of MIT and former science advisor to President Kennedy, pointed to the critical problem of who will control the vast powers of the computer. "The only thing I'm sure of " he said; "is it shouldn't be left in the hands of the politicians. Some way must be found to diffuse the centralization of the vast amounts of information being collected."

The seminar was held in conjunction with the

dedication of a new \$3 1/2 million Information Processing Center at MIT.

GREYHOUND COMPUTER CORP. HAS SIGNED A MAJOR CONTRACT WITH GENERAL ELECTRIC CO. for the manufacture, to Greyhound specifications, of a new disc drive. The new product is designed for use on third generation computers, including the IBM System/360. The unit will have a storage capacity of 7.25 million bytes of information on 10 disc surfaces, and will provide users with high speed access to data in random or sequential mode. The new disk drive will be available to customers in January, 1969.

A FLAW IN PROGRAMMING CAUSED THE ERRORS IN COMPUTING ELECTION RETURNS last month, according to J. Richard Eimers, the executive director of News Election Service, the cooperative organization formed by major news media to insure a single set of accurate vote totals from the national election Nov. 5. Although more than 10,000 man-hours were said to have been consumed in programming the system, problems began to show up around 10 p.m. At one point, the computer reported that 177 percent of the vote had been cast in the South Dakota senatorial race. The computers were later removed from service, and a slower back-up system of tallying votes had to be used. It will probably be some time before the specific programming errors are pinpointed.

NEW INSTALLATIONS

TO	FROM	FOR	AMOUNT
Technical Information Services Co. (TISCO), a subsidiary of Informatics Inc., Sherman Oaks, Calif.	National Aeronautics and Space Administration	Operation of NASA's Scientific and Technical Information Facility at College Park, Md., through November 1969, with an option for extensions for two succeeding one-year periods	over \$4 million
UNIVAC Federal Systems Div., Sperry Rand Corp., Philadelphia, Pa.	National Aeronautics and Space Administration, Washington, D.C.	Operational engineering support for the UNIVAC 494 computers in the Communications Command and Telemetry System (CCATS), a key part of the Apollo lunar landing mission	about \$2.7 million
Link Group of Singer-General Precision, Inc., Binghamton, N.Y.	Scandinavian Airlines	A Link DC-9 flight simulator; the Link VAMP [®] (Visual anamorphic Motion Picture) visual system enables pilots to practice approaches, landings and takeoffs in all types of weather conditions	about \$2 million
Burroughs Corp., Detroit, Mich.	Don Clark & Associates, Inc., Charlotte, N.C. and Omaha, Nebr.	Four B3500 computer systems to be used in a network of service centers to serve the hospital industry; the first of these will be located in Columbia, S.C.	\$1.7 million
Ampex Corp., Redwood City, Calif.	Western Electric Co.	Magnetic tape transports for use in new automatic Electronic Switching Systems (ESS) centers being installed for the Bell Telephone System in the United States and Canada	over \$1.5 million
LTV Electrosystems, Inc., Dallas, Texas	Lockheed-California Company	A pilot's longitudinal feel system including a force unit and computer for the flight control system	about \$1.5 million
International Computers, Ltd. Great Britain	British American Insurance Co., Kingston, Jamaica	A 1902A computer system which will store a file of over 800,000 British American policies providing a higher level of service for the company's 600 agents in the Caribbean	\$1.2 million
Honeywell Inc.	American Airlines	20 Honeywell computers to concentrate and transmit data for its passenger reservation system; first installations are planned for nine major cities from coast-to-coast	over \$1 million
Control Data Corp., Minneapolis, Minn.	U.S. Army Sentinel System Command, Redstone Arsenal, Ala.	A CDC 3300 computer system to be used in connection with Missile Test and Evaluation programs at the Army's Kwajalein Missile Range in the Pacific Ocean	\$922,000
Computer Sciences Corp., Los Angeles, Calif.	Naval Command Systems Support Activity	Development of computer programs which will process information on operations, logistics, communications and personnel for the U.S. Military Assistance Command in Vietnam	\$600,000
Wyle Laboratories Western Test Division, El Segundo, Calif.	Rocketdyne Division of North American Rockwell Corp., Calif.	Testing the liquid-fueled rocket propulsion system for the Navy's Condor air-to-ground missile	\$500,000
System Development Corp., Santa Monica, Calif.	Advanced Research Projects Agency of the Department of Defense	Assisting the Royal Thailand Government in improvement of its data processing capabilities; a primary task will be to help solve computer programming problems due to the intricate Thai language (most words have no one-to-one corresponding English equivalent)	\$430,000
Brogan Associates, Inc., Westbury, N.Y.	MAI Equipment Corp.	The development and manufacture of a special processor for use with present MAI accounting machines	over \$275,000
Computer Usage Co., Inc., Washington, D.C.	National Institute of Health	Analysis and programming support to the Division of Computer Research and Technology of the NIH in the areas of business data processing, statistical analysis and simulation	\$203,000
Lockheed Missiles & Space Co., a division of Lockheed Aircraft Corp., Sunnyvale, Calif.	Health Care Services, State of California	Performing a total management systems study for the Medi-Cal Program, which provides services to over 1½ million medically needy persons in California	\$195,000
Standard Memories Inc., Santa Ana, Calif. (a subsidiary of Applied Magnetics Corp., Goleta, Calif.)	MAI Equipment Corp., New York, N.Y.	Development and manufacture of Expansion Memory Modules designed with third generation circuits for use with certain IBM second generation computer systems; the equipment will be for sale or lease by MAI on an exclusive marketing basis	about \$150,000
Computer Usage Co., Inc., Washington, D.C.	Office of Economic Opportunity	Consulting services to five states in the development of Management Information Systems for reporting and controlling funds supporting the war on poverty	\$118,175
Scientific Data Systems, El Segundo, Calif.	Johnson Service Co., Milwaukee, Wis.	Seven SDS Sigma 2 computers which will be used to monitor and control the air conditioning, heating, lighting, and other facilities services for a variety of new multi-story bank buildings, medical buildings, educational institutions, and government offices presently under construction or rejuvenation throughout the United States and Canada	—

NEW CONTRACTS

OF	AT	FOR
Burroughs B340 system	First National Bank, Massillon, Ohio	Proof and transit, demand deposit accounting, mortgage loans, installment loans, Christmas club accounting, and payroll. (system valued at over \$180,000)
Burroughs B500 system	Tucson Federal Savings and Loan Association, Tucson, Ariz.	Handling the association's 65,000 savings and 12,000 loan accounts; also will offer data processing services to other commercial and financial institutions (system valued at nearly \$600,000)
Burroughs B500 system	National American Bank of New Orleans, La.	On-line servicing for financial and commercial firms (system valued at over \$400,000)
Control Data 1700 system	Bonneville Power Administration, Portland, Ore.	Use with a CDC 6400 (already installed) in a real-time data processing installation to perform power system data management and system control computation
Control Data 6600/1700 system	Babcock & Wilcox, Lynchburg, Va.	Engineering and scientific computations in simulating nuclear steam systems designed and built by the firm
Control Data 6600 system	Raytheon Co., Missile Systems Div., Bedford, Mass.	Integration with a large-scale analog computer; system will be capable of running multiple hybrid missile simulations, as well as digital scientific computations, on a concurrent basis
GE-4020 system	University of London, London, England	A central computer service to all areas of the University for use in research and teaching
	Phoenix Steel Corp., Calymont, Del.	Monitoring such items as electrical load and temperature for two new electric furnaces
Honeywell Model 120 system	Board of Education, Borough of York, Toronto, Canada	Use as a laboratory tool for students taking data processing classes; some administrative tasks
	Gould's Inc., Louisville, Ky.	Customer billing, accounting, payroll and sales analysis functions for the firm
	Green Cross General Hospital, Cuyahoga Falls, Ohio	In-patient and out-patient accounts, payroll and, later, statistical data and research
	Kawecki Chemical Co., Boyertown, Pa.	Replacing tabulating system to control several aspects of financial accounting, inventory sales and project scheduling
Honeywell Model 1200 system	Scottish & Newcastle Breweries Ltd., Edinburgh, Scotland	Accounting, sales analysis, credit control, stock control and sales forecasting (system valued at \$600,000)
	Peterson, Howell & Heather Inc., Baltimore, Md. (twin H-1200 systems)	Expansion of its service in managing over 120,000 automobiles, trucks and airplanes; firm offers specialized management or leasing services for national corporations that operate large fleets of vehicles for sales and service personnel (system valued at \$1.3 million)
Honeywell Model 2200 system	Rubery Owen, Darlston, England	Forming the basis of a proposed production control and management information system. This diversified engineering group pioneered computer use by British industry in the late 1950s
IBM System/360 Model 25	Missouri Power & Light Co., Jefferson City, Mo.	Handling growing volume of customer and company accounting tasks; later other functions will be added
IBM System/360 Model 30	The Fairfield County Trust Co., Stamford, Conn.	Speeding information on checking accounts, savings accounts and installment loans via an audio response unit connected to the Model 30
IBM System/360 Model 40	Wisconsin Electric Power Company, Milwaukee, Wis.	An electronic customer service program
IBM System/360 Model 50	Firestone Tire & Rubber Co., Akron, Ohio	Nerve center of firm's centralized computer-based communications network, an inventory management system which serves 110 Firestone plants, warehouses and district offices nationwide
IBM 1130 system	Boston Latin School, Boston, Mass.	Teaching programming to 300 juniors and seniors; also used in "open shop" sessions in which students undertake projects of their own choosing
	Sherwin-Williams Co., Cleveland, Ohio	Helping select proper pigments and concentrations to match color samples submitted by customers, and in developing new paint formulas
NCR Century-100 system	Steiger's Department Store, Springfield, Mass.	Sales analysis and payroll; accounts payable and inventory control will be added later
NCR-315 system	First National Bank, Hobbs, N.M.	Use as the control center for savings, demand deposit and installment accounting
RCA Spectra 70/55 system	Emory University Computing Center, Atlanta, Ga.	General administrative data processing as well as time sharing via RCA's Basic Time Sharing System (BTSS) software package
SDS Sigma 2 system	Compuscan, Leonia, N.J.	Analyzing electrocardiograms, infrared spectra, seismic record sections, weather maps, and other graphically recorded data for a variety of subscribers
UNIVAC 494 system	Iberia Airlines, Madrid, Spain (two systems)	An automatic seat reservation system (systems valued at over \$3 million)
UNIVAC 9200 system	Security Federal Savings & Loan Association, East Chicago, Ill.	Loan, fixed asset and general ledger accounting

MONTHLY COMPUTER CENSUS

The following is a summary made by "Computers and Automation" of reports and estimates of the number of general purpose electronic digital computers manufactured and installed, or to be manufactured and on order. These figures are mailed to individual computer manufacturers from time to time for their information and review, and for any updating or comments they may care to provide.

Our census has begun to include computers manufactured by organizations outside the United States. We invite all manufacturers located anywhere to submit information for this census. We also invite our readers to submit information that would help make these figures as accurate and complete as possible.

The following abbreviations apply:

- (R) - figures derived all or in part from information released directly or indirectly by the manufacturer, or from reports by other sources likely to be informed
- (N) - manufacturer refuses to give any figures on number of installations or of orders, and refuses to comment in any way on those numbers stated here
- (S) - sale only
- X - no longer in production
- C - figure is combined in a total (see column to the right)
- E - figures estimated by Computers and Automation
- ? - information not received at press time

AS OF NOVEMBER 15, 1968

NAME OF MANUFACTURER	NAME OF COMPUTER	AVERAGE OR RANGE OF MONTHLY RENTAL	DATE OF FIRST INSTALLATION	NUMBER OF INSTALLATIONS	MFR'S TOTAL INSTAL-LATIONS	NUMBER OF UNFILLED ORDERS	MFR'S TOTAL UNFILLED ORDERS
I. United States Manufacturers							
Autonetics (R) Anaheim, Calif.	RECOMP II	\$2495	11/58	30		X	
	RECOMP III	\$1495	6/61	6	36	X	0
Bailey Meter Co. Wickliffe, Ohio	Bailey 756	\$60,000-\$400,000 (S)	2/65	17		3	
	Bailey 855	\$100,000 (S)	4/68	0	17	15	18
Bunker-Ramo Corp. (R) Canoga Park, Calif.	BR-130	\$2000	10/61	160		X	
	BR-133	\$2400	5/64	62		X	
	BR-230	\$2680	8/63	15		X	
	BR-300	\$3000	3/59	18		X	
	BR-330	\$4000	12/60	23		X	
	BR-340	\$7000	12/63	19	297	X	0
Burroughs (R) Detroit, Mich.	205	\$4600	1/54	38		X	
	220	\$14,000	10/58	31		X	
	B200 Series, B100	\$5400	11/61	800		31	
	B300 Series	\$9000	7/65	370		150	
	B500	\$3800	10/68	0		70	
	B2500	\$5000	2/67	57		117	
	B3500	\$14,000	5/67	44		190	
	B5500	\$22,000	3/63	74		8	
	B6500	\$33,000	2/68	4		31	
	B7500	\$44,000	4/69	0		13	
	B8500	\$200,000*	8/67	1	1430 E	5	550 E
Control Data Corp. (R) Minneapolis, Minn.	G-15	\$1600	7/55	295		X	
	G-20	\$15,500	4/61	20		X	
	LGP-21	\$725	12/62	165		X	
	LGP-30	\$1300	9/56	322		X	
	RPC-4000	\$1875	1/61	75		X	
	636/136/046 Series	?	-	29		C	
	160*/8090 Series	\$2100-\$14,000	5/60	610		X	
	924/924A	\$11,000	8/61	29		X	
	1604/A/B	\$45,000	1/60	59		X	
	1700	\$3500	5/66	100		C	
	3100/3200/3300	\$10,000-\$16,250	5/64	311		C	
	3400/3600/3800	\$18,000-\$48,750	6/63	79		C	
	6400/6500/6600	\$52,000-\$117,000	8/64	77		C	
	6800	\$130,000	6/67	0		C	
	7600	\$150,000	12/68	0	1900 E	C	300 E
Datacraft Corp. Ft. Lauderdale, Fla.	DC6024	\$1300	1/69	0	0	3	3
Data General Corp. Hudson, Mass.	NOVA	\$7950 (S)	1/68	0	0	0	0
Digital Electronics Inc. (R) Plainview, N.Y.	DIGIAC 3080	\$19,500 (S)	12/64	11		1	
	DIGIAC 3080C	\$25,000 (S)	10/67	1	12	1	2
Digital Equipment Corp. (R) Maynard, Mass.	PDP-1	\$3400	11/60	48		X	
	PDP-4	\$1700	8/62	32		X	
	PDP-5	\$900	9/63	100		X	
	PDP-6	\$10,000	10/64	21		X	
	PDP-7	\$1300	11/64	99		X	
	PDP-8	\$525	4/65	1372		C	
	PDP-8/S	\$300	9/66	872		C	
	PDP-8/I	\$425	3/68	473		C	
	PDP-8/L	?	11/68	4		C	
	PDP-9	\$1000	12/66	300		C	
	PDP-9/L	?	-	0		C	
	PDP-10	\$7500	12/67	27		C	
	LINC-8	?	9/66	135	3483	C	450 E
Electronic Assoc., Inc. (R) Long Branch, N.J.	640	\$1200	4/67	42		18	
	8400	\$12,000	7/65	21	63	4	22
EMR Computer Div. (R) Minneapolis, Minn.	ASI 210	\$3850	4/62	C		X	
	ASI 2100	\$4200	12/63	C		X	
	ADVANCE 6020	\$4400	4/65	C		C	
	ADVANCE 6040	\$5600	7/65	C		C	
	ADVANCE 6050	\$9000	2/66	C		C	
	ADVANCE 6070	\$15,000	10/66	C		C	
	ADVANCE 6130	\$1550	8/67	23	89	C	37
General Electric (N) Phoenix, Ariz.	115	\$1370-\$5000	4/66	720 E		600 E	
	130	\$4350-\$15,000	-	0		C	
	205	\$2500-\$10,000	6/64	C		X	
	210	\$16,000-\$22,000	7/60	C		X	
	215	\$2500-\$10,000	9/63	C		X	
	225	\$2500-\$16,000	4/61	200 E		X	
	235	\$6000-\$18,000	4/64	130 E		C	
	255 T/S	\$15,000-\$19,000	10/67	C		C	
	265 T/S	\$17,000-\$20,000	10/65	C		C	
	405	\$5120-\$10,000	2/68	C		C	
	415	\$4800-\$13,500	5/64	380 E		70 E	
	420 T/S	\$17,000-\$20,000	6/67	C		C	
	425	\$6000-\$20,000	6/64	130 E		C	

NAME OF MANUFACTURER	NAME OF COMPUTER	AVERAGE OR RANGE OF MONTHLY RENTAL	DATE OF FIRST INSTALLATION	NUMBER OF INSTALLATIONS	MFR'S TOTAL INSTALLATIONS	NUMBER OF UNFULFILLED ORDERS	MFR'S TOTAL UNFULFILLED ORDERS	
General Electric (cont'd)	430 T/S	\$15,500-\$19,000	-	0		C		
	435	\$8000-\$25,000	9/65	C		C		
	440 T/S	\$22,200-\$27,000	-	0		C		
	625 T/S	\$31,000-\$125,000	4/65	C		C		
	635 T/S	\$35,000-\$167,000	5/65	C		C		
	645	\$40,000-\$250,000	7/66	C	1900 E	C	900 E	
Hewlett-Packard (R) Palo Alto, Calif.	2116A	\$600	11/66	106		C		
	2115A	\$412	11/67	140		C		
	2116B	\$650	5/68	34		C		
	2114A	\$250	5/68	55	335	C	50 E	
Honeywell (R) Computer Control Div. Framingham, Mass.	DDP-24	\$2500	5/63	93		X		
	DDP-116	\$900	4/65	200		30		
	DDP-124	\$2050	3/66	64		30		
	DDP-224	\$3300	3/65	52		8		
	DDP-516	\$700	9/66	155		150		
	H632	\$2700	-	0	564	?	218	
Honeywell (R) EDP Division Wellesley Hills, Mass.	H-110	\$2500	8/68	0		90		
	H-120	\$4000	1/66	650		240		
	H-125	\$5000	12/67	22		75		
	H-200	\$8500	3/64	800		87		
	H-400	\$11,000	12/61	52		X		
	H-800	\$28,000	12/60	59		X		
	H-1200	\$9500	2/66	175		130		
	H-1250	\$12,000	7/68	0		20		
	H-1400	\$14,000	1/64	7		X		
	H-1800	\$50,000	1/64	16		X		
	H-2200	\$26,000	1/66	88		71		
	H-4200	\$26,000	8/68	0		20		
	H-8200	\$50,000	12/68	0		1869 E	5	700 E
	IBM (N) White Plains, N.Y.	305	\$3600	12/57	C		X	
360/20		\$3000	12/65	7700 E		4200 E		
360/25		\$5330	1/68	C		1800 E		
360/30		\$9340	5/65	7400 E		2300 E		
360/40		\$19,550	4/65	3500 E		1100 E		
360/44		\$15,000	7/66	C		C		
360/50		\$32,960	8/65	C		C		
360/65		\$69,850	11/65	C		C		
360/67		\$138,000	10/66	C		C		
360/75		\$81,400	2/66	C		C		
360/85		\$115,095	-	0		C		
360/90 Series		-	10/67	C		C		
650		\$4800	11/54	C		X		
1130		\$1545	2/66	4000 E		4300 E		
1401		\$6480	9/60	6300 E		X		
1401-G		\$2300	5/64	1460 E		X		
1401-H		\$1300	6/67	C		C		
1410		\$17,000	11/61	C		C		
1440		\$4300	4/63	3360 E		C		
1460		\$10,925	10/63	1140 E		X		
1620 I, II		\$4000	9/60	1500 E		C		
1800		\$4800	1/66	C		C		
701		\$5000	4/53	C		X		
7010		\$26,000	10/63	C		C		
702		\$6900	2/55	C		X		
7030		\$160,000	5/61	C		X		
704		\$32,000	12/55	C		X		
7040		\$25,000	6/63	C		C		
7044		\$36,500	6/63	C		C		
705		\$38,000	11/55	C		X		
7070, 2, 4		\$27,000	3/60	C		X		
7080		\$60,000	8/61	C		X		
709		\$40,000	8/58	C		X		
7090	\$63,500	11/59	C		X			
7094	\$75,500	9/62	C		X			
7094 II	\$82,500	4/64	C		42,100 E	C	16,000 E	
Interdata (R) Oceanport, N.J.	Model 2	\$200-\$300	7/68	3		1		
	Model 3	\$300-\$500	3/67	105		35		
	Model 4	\$400-\$800	8/68	6	114	22	58	
National Cash Register Co. (R) Dayton, Ohio	NCR-304	\$14,000	1/60	24		X		
	NCR-310	\$2500	5/61	10		X		
	NCR-315	\$8500	5/62	700		150		
	NCR-315-RMC	\$12,000	9/65	105		50		
	NCR-390	\$1850	5/61	1200		6		
	NCR-500	\$1500	10/65	2000		580		
	NCR-Century-100	\$2645	-	-		C		
	NCR-Century-200	\$7500	-	-	4039	C	1050 E	
Pacific Data Systems Inc. (R) Santa Ana, Calif.	PDS 1020	\$550-\$900	2/64	145	145	10	10	
Philco (R) Willow Grove, Pa.	1000	\$7010	6/63	16		X		
	2000-210, 211	\$40,000	10/58	16		X		
	200-212	\$52,000	1/63	12	44	X	0	
Potter Instrument Co., Inc. Plainview, N.Y.	PC-9600	\$12,000 (S)	-	-	-	-	-	
Radio Corp. of America (R) Cherry Hill, N.J.	RCA 301	\$7000	2/61	635		C		
	RCA 3301	\$17,000	7/64	75		C		
	RCA 501	\$14,000	6/59	96		X		
	RCA 601	\$35,000	11/62	3		X		
	Spectra 70/15	\$4500	9/65	190		120		
	Spectra 70/25	\$6500	9/65	102		57		
	Spectra 70/35	\$10,400	1/67	60		135		
	Spectra 70/45	\$22,000	11/65	110		85		
	Spectra 70/46	\$34,400	-	0		C		
	Spectra 70/55	\$34,300	11/66	7	1270 E	14	420 E	
Raytheon (R) Santa Ana, Calif.	250	\$1200	12/60	175		X		
	440	\$3500	3/64	20		X		
	520	\$3200	10/65	27		0		
	703	(S)	10/67	70	292	20	20	
Scientific Control Corp. (R) Dallas, Tex.	650	\$500	5/66	23		0		
	655	\$1800	10/66	63		15		

NAME OF MANUFACTURER	NAME OF COMPUTER	AVERAGE OR RANGE OF MONTHLY RENTAL	DATE OF FIRST INSTALLATION	NUMBER OF INSTALLATIONS	MFR'S TOTAL INSTAL-LATIONS	NUMBER OF UNFULFILLED ORDERS	MFR'S TOTAL UNFULFILLED ORDERS
Scientific Control Corp. (cont'd)	660	\$2000	10/65	9		6	
	670	\$2600	5/66	1		0	
	6700	\$30,000	10/67	0		1	
	4700	\$500	2/69	0		14	
	6700	\$30,000	10/67	0	96	2	32
Scientific Data Syst., Inc. (N) Santa Monica, Calif.	SDS-92	\$1500	4/65	120 E		10 E	
	SDS-910	\$2000	8/62	225 E		25 E	
	SDS-920	\$2900	9/62	200 E		20	
	SDS-925	\$3000	12/64	C		C	
	SDS-930	\$3400	6/64	235 E		30	
	SDS-940	\$10,000	4/66	C		C	
	SDS-9300	\$7000	11/64	C		C	
	Sigma 2	\$1000	12/66	95 E		160	
Sigma 5		\$6000	8/67	C		50	
	Sigma 7	\$12,000	12/66	C	1045 E	C	320 E
Standard Computer Corp. (N) Los Angeles, Calif.	IC 4000	\$9000	7/68	0		2 E	
	IC 6000	\$10,000-\$22,000	5/67	7	7	12 E	14 E
Systems Engineering Labs (R) Ft. Lauderdale, Fla.	SEL 810	\$1000	9/65	24		X	
	SEL 810A	\$900	8/66	91		34	
	SEL 810B	\$1200	9/68	4		18	
	SEL 840	\$1400	11/65	4		X	
	SEL 840A	\$1400	8/66	33		X	
	SEL 840 MP	\$2000	1/68	7	163	20	72
UNIVAC, Div. of Sperry Rand (R) New York, N.Y.	I & II	\$25,000	3/51 & 11/57	23		X	
	III	\$20,000	8/62	77		X	
	File Computers	\$15,000	8/56	13		X	
	Solid-State 80 I, II, 90, I, II & Step	\$8000	8/58	210		X	
	418	\$11,000	6/63	135		20	
	490 Series	\$35,000	12/61	200		35	
	1044	\$1900	2/63	3000 E		20	
	1005	\$2400	4/66	1150		90	
	1050	\$8000	9/63	280		10	
	1100 Series (except 1107 & 1108)	\$35,000	12/50	9		X	
	1107	\$55,000	10/62	33		X	
	1108	\$65,000	9/65	105		75	
	9200	\$1500	6/67	230		850	
	9300	\$3400	7/67	125		550	
	9400	\$7000	5/69	0		60	
LARC	\$135,000	5/60	2	5592 E	X	1670 E	
Varian Data Machines (R) Newport Beach, Calif.	620	\$900	11/65	75		0	
	620i	\$500	6/67	255		430	
	520i	-	10/68	8	338	-	430
I. U.S. Manufacturers, TOTAL —					67,200 E		23,300 E
II. Non-United States Manufacturers							
A/S Norsk Data-Elektronikk Oslo, Norway	NORD 1	\$1000	8/68	5		3	
	NORD 2	\$200	8/69	0	5	0	3
A/S Regnecentralen (R) Copenhagen, Denmark	GIER	\$2300-\$7500	12/60	37		1	
	RC 4000	\$3000-\$20,000	6/67	1	38	1	2
Elbit Computers Ltd. (R) Haifa, Israel	Elbit-100	\$4900 (S)	10/67	35	35	15	15
English Electric Computers Ltd. (R) London, England	LEO I	-	-/53	3		X	
	LEO II	-	6/57	11		X	
	LEO III	\$9600-\$24,000	4/62	39		X	
	LEO 360	\$9600-\$28,800	2/65	8		X	
	LEO 326	\$14,400-\$36,000	5/65	11		X	
	DEUCE	-	4/55	32		X	
	KDF 6	-	12/63	17		X	
	KDF 8-10	-	9/61	12		X	
	KDF 9	\$9600-\$36,000	4/63	28		X	
	KDN 2	-	4/63	8		X	
	KDF 7	\$1920-\$12,000	5/66	8		X	
	SYSTEM 4-30	\$3600-\$14,400	10/67	3		C	
	SYSTEM 4-40	\$7200-\$24,000	5/69	-		C	
	SYSTEM 4-50	\$8400-\$28,800	5/67	9		C	
	SYSTEM 4-70	\$9600-\$36,000	1/68	2		C	
	SYSTEM 4-75	\$9600-\$40,800	9/68	-		C	
	ELLIOTT 903	\$640-\$1570	1/66	52		C	
ELLIOTT 4120	\$1600-\$4400	10/65	82		C		
ELLIOTT 4130	\$2200-\$9000	6/66	23	348	C	110	
GEC-AEI Automation Ltd. (R) New Parks, Leicester, England	Series 90-2/10/20/25/ 30/40/300	-	1/66	13		X	
	S-Two	-	3/68	1		X	
	130	-	12/64	2		X	
	330	-	3/64	9		X	
	959	-	-/65	1		X	
	1010	-	12/61	8		X	
	1040	-	7/63	1		X	
	CON/PAC 4020	-	-	0		C	
	CON/PAC 4040	-	5/66	9		C	
	CON/PAC 4060	-	12/66	5	49	C	8
	International Computers Limited (R) London, England	1200/1/2	\$900	-/55	62		X
1300		\$3000	-/63	79		X	
1301		\$5000	-/61	127		X	
1500		\$6000	-/62	125		X	
1100		\$5000	-/60	23		X	
2400		\$23,000	-/61	4		X	
Atlas 1 & 2		\$65,000	-	6		X	
Orion 1 & 2		\$20,000	-/63	17		X	
Sirius		-	-/61	22		X	
Mercury		-	-	19		X	
Pegasus 1 & 2		-	-/56	33		X	
1901		\$4000	9/66	328		112	
1902		\$4800	7/65	189		24	
1903	\$6500	7/65	99		20		

C.a PROBLEM CORNER

Walter Penney, CDP
Problem Editor
Computers and Automation

PROBLEM 6812: AN ARABIC GRAY CODE

"What in the world is an Ashhab Code?" Joe asked, reading over Al's shoulder.

Al looked up from the sheet he had been working on. "According to the boss, Ashhab is the Arabic word for 'gray'. This is a little joke of his, calling an Arabic Gray Code an Ashhab Code."

"But isn't a Gray Code a binary code with only one bit changing at each step? Those numbers don't look like binary to me — or octal either since I see some 8's and 9's there."

"You're right. These are ordinary Arabic decimal numbers. But they're so arranged that only one digit changes at each step. Hence the name — Arabic Gray Code, or Ashhab Code."

Joe studied the list. "A lot of them seem to be the same. The numbers 1 to 9 are the same, then 10 is 19, 11 is 18, and so on, until 19 is 10. But all the 20's are the same; in fact every even set of ten seems to be unchanged."

"It's not that simple." Al pointed to a block of numbers on his sheet. "99 is 90 in Ashhab, but 100 is 190, 101 is 191,

and so on, until 199 is 100. Thus every number in the range 100 to 199 is different."

"Well, at least all the leading digits are the same," Joe said a little defensively.

"Yes, and since so many numbers are the same I thought I'd make provision only for those that are different. I'm trying to figure out now how many of these there are."

"How many numbers do you have to consider altogether?"

"Well, I'm going to assume our numbers never have more than five digits. We'll have to consider then every number from 1 to 99,999 inclusive."

How many numbers will be the same in both systems?

Solution to Problem 6811: Saving Computer Time

The program would compute

$$Q = \sqrt{25 + 8\sqrt{27 + 9\sqrt{29 + \dots}}}$$

the value of which is 11.

Readers are invited to submit problems (and their solutions) for publication in this column to: Problem Editor, Computers and Automation, 815 Washington St., Newtonville, Mass. 02160.

NAME OF MANUFACTURER	NAME OF COMPUTER	AVERAGE OR RANGE OF MONTHLY RENTAL	DATE OF FIRST INSTALLATION	NUMBER OF INSTAL-LATIONS	MFR'S TOTAL INSTAL-LATIONS	NUMBER OF UNFILLED ORDERS	MFR'S TOTAL UNFILLED ORDERS
International Computers Limited (cont'd)	1904	\$12,200	5/65	58		5	
	1905	\$13,000	12/64	31		3	
	1909	\$5500	8/65	17		1	
	1906	\$28,000	12/66	4		1	
	1907	\$29,000	12/66	9		0	
	1904E	\$16,000	1/68	8		34	
	1905E	\$16,500	1/68	4		15	
	1904F	\$17,000	-	-		9	
	1905F	\$17,500	-	-		12	
	1906E	\$29,300	-	-		2	
	1907E	\$30,300	3/68	1		1	
	1906F	\$31,200	-	-		2	
	1907F	\$32,500	-	-		2	
	1901A	\$3700	3/68	1		102	
	1902A	\$3600	-	-		72	
	1903A	\$10,600	9/67	2		7	
1904A	\$18,600	-	-		1		
1906A	\$54,000	-	-		1		
Japanese mfrs.	Various models	-	-	C	1268		426
The Marconi Co., Ltd. Chelmsford, Essex, England	Myriad I	£36,000-£66,000	3/66	26	2074 E	C	500 E
	Myriad II	£22,000-£42,500	10/67	8	34	10	29
N.V. Philips' Computer IndustrieP1000 Apeldoorn, Netherlands		?	6/68	0	0	5 E	5 E
Saab Aktiebolag (R) Linköping, Sweden	DATASAAB D21	\$5000-\$14,000	12/62	32		2	
	DATASAAB D22	\$8000-\$60,000	5/68	1	33	11	13
Siemens Aktiengesellschaft Munich, Germany	2002	54,000 (Deutsche Marks)	6/59	42		-	
	3003	52,000	12/63	34		1	
	4004/15/16	19,000	10/65	70		15	
	4004/25/26	32,000	1/66	31		8	
	4004/35	46,000	2/67	69		61	
	4004/45	75,000	7/66	59		40	
	4004/55	103,000	12/66	4		2	
	301	2000	-	1		14	
	302	4000	9/67	13		8	
	303	10,000	4/65	67		8	
	304	12,000	-	14		20	
	305	14,000	11/67	21	425	26	203
Union of Soviet Socialist Republics	BESM 4	-	-	C		C	
	BESM 6	-	-	C		C	
	MINSK 2	-	-	C		C	
	MINSK 22	-	-	C		C	
	MIR	-	-	C		C	
	NAIRI	-	-	C		C	
	ONEGA 1	-	-	C		C	
	ONEGA 2	-	-	C		C	
	URAL 11/14/16 and others	-	-	C		C	
					2500 E		700 E
II. Non-U.S. Manufacturers, TOTAL					—	6000 E	2000 E
Combined, TOTAL					—	74,000 E	25,300 E

NEW PATENTS

Raymond R. Skolnick
Patent Manager
Ford Instrument Co.
Div. of Sperry Rand Corp.
Long Island City, N.Y. 11101

The following is a compilation of patents pertaining to computers and associated equipment from the "Official Gazette of the U. S. Patent Office," dates of issue as indicated. Each entry consists of: patent number / inventor(s) / assignee / invention. Printed copies of patents may be obtained from the U.S. Commissioner of Patents, Washington, D.C. 20231, at a cost of 50 cents each.

October 1, 1968

- 3,404,375 / Richard L. Snyder, Fullerton, Calif. / Hughes Aircraft Company, Culver City, Calif., a corporation of Delaware / Combination random access and mass store memory.
- 3,404,377 / Stanley P. Frankel, 411 N. Martel, Los Angeles, Calif. 90036 / — / General purpose digital computer.
- 3,404,382 / Albert D. Rosenheck, Orange, and Douglas R. Maure, South Pasadena, Calif. / by mesne assignments, to Lear Siegler, Inc., Santa Monica, Calif., a corporation of Delaware / Capacitive semi-permanent memory.
- 3,404,384 / Richard L. Snyder, Fullerton, Calif. / Hughes Aircraft Company, Culver City, Calif., a corporation of Delaware / Wire memory storage system.
- 3,404,386 / Donald H. Montgomery, Mantua, and Stuart T. Jolly, Collingswood, N.J. / Radio Corporation of America, a corporation of Delaware / Fixed read-only memory.
- 3,404,389 / Jean Henri Cocquart, Boulogne-Billancourt, France / Societe Industrielle Bull-General Electric (Societe Anonyme), Paris, France / Matrix memory assembly.
- 3,404,390 / Yves-Jean Francois Brette, Sevres, and Michel Carbonel, Fontenay-sous-Bois, France / Societe Industrielle Bull-General Electric (Societe Anonyme), Paris, France / Magnetic core shift register.

October 8, 1968

- 3,405,396 / Myron J. Mendelson, Encino, and Alfred W. England, Reseda, Calif. / Scientific Data Systems, Inc., Santa Monica, Calif., a corporation of Delaware / Digital data processing systems.
- 3,405,398 / William B. Johnson, Richfield, Minn. / Sperry Rand Corp., New York, N.Y., a corporation of Delaware / Thin film detector.
- 3,405,399 / Carlos F. Chong and Charles A. Nelson, Philadelphia, Pa. / Sperry Rand Corporation, New York, N.Y., a

corporation of Delaware / Matrix Selection circuit.

- 3,405,400 / Hemmige Venkata Rangachar, Collingswood, and Luke Dillon, Jr., Burlington, N. J. / Radio Corporation of America, a corporation of Delaware / Nondestructive readout memory.

October 15, 1968

- 3,406,379 / Max Palevsky and Leon Levine, Los Angeles, and Ralph T. Dames, Redondo Beach, Calif. / Scientific Data Systems, Inc., Santa Monica, Calif., a corporation of Delaware / Digital data processing system.

October 22, 1968

- 3,407,392 / Takashi Ishidate, Minatoku, Tokyo, Japan / Nippon Electric Company Ltd., Minatoku, Tokyo, Japan, a corporation of Japan / Storage element location compensation in matrix memories by a delay means.
- 3,407,393 / Ralph W. Haas, Chatsworth, and Wilfried H. Hell, Woodland Hills, Calif. / The Marquardt Corporation, Van Nuys, Calif., a corporation of California / Electro-optical associative memory.

October 29, 1968

- 3,408,634 / Walter W. Lec, Allendale, N. J., Arthur S. Robinson, South Huntington, N. Y., David H. Blauvelt, Ridgewood, and Israel L. Fischer,

Harrington Park, N. J. / The Bendix Corporation, Teterboro, N. J., a corporation of Delaware / Optical memory system.

- 3,408,635 / Edwin S. Lee III, Altadena, Calif. / Burroughs Corporation, Detroit, Mich., a corporation of Michigan / Twistor associative memory system.
- 3,408,636 / Reginald Hugh Allmark and Warwick Reginald Abbott, Kidsgrove, Stoke-on-Trent, England / The English Electric Company Ltd., London, England, a British company / Electric data shift register.
- 3,408,637 / Robert G. Gibson, Binghamton, Richard A. Steigerwald, Vestal, N. Y., and Richard A. Ide, Sweet Valley, Pa. / International Business Machines Corporation, New York, N. Y., a corporation of New York / Address modification control arrangement for storage matrix.
- 3,408,638 / Lester M. Spandorfer, Cheltenham, Pa. / Sperry Rand Corporation, N. Y., N. Y., a corporation of Delaware / Read-write network for content addressable memory.
- 3,408,639 / Katsuro Nakamura, Tokyo-to, Japan / Toko Kabushiki Kaisha, Tokyo-to, Japan, a joint-stock company of Japan / Magnetic memory device.
- 3,408,640 / Claude Marie Edmond Masson, Asnieres, France / Societe d'Electronique et d'Automatisme, Courbevoie, Hauts-de-Seine, France / Readout circuitry for high density dynamic magnetic stores. ■

ADVERTISING INDEX

Following is the index of advertisements. Each item contains: Name and address of the advertiser / page number where the advertisement appears / name of agency if any.

American Telephone & Telegraph Co.,
 195 Broadway, New York, N. Y.
 10017 / Page 3 / N. W. Ayer & Son
 Compro, 1060 North Kings Highway,
 Cherry Hill; N. J. 08034 / Page
 20 / —

Computer Packs Unlimited, 232 East
 Ohio St., Chicago, Ill. 60611 / Page
 7 / Persuasion Systems, Inc.

Computer Exchange, 30 East 42 St.,
 New York, N. Y. 10017 / Page 11 /
 Howard Marks Advertising/Norman,
 Craig & Kummel Inc.

Digital Equipment Corp., 146 Main
 St., Maynard, Mass. 01754 / Pages
 36 and 37 / Kalb & Schneider Inc.

Edutronics, Inc., 2790 Harbor Blvd.,
 Costa Mesa, Calif. 92626 / Page 2
 / Durel Advertising

Information International, Inc., 545
 Technology Square, Cambridge,

Mass. 02139 / Page 29 / Kalb &
 Schneider Inc.

Infotechnics, Inc., 15730 Stagg St.,
 Van Nuys, Calif. 91406 / Page 13 /
 Burrell Advertising

Miller-Stephenson Chemical Co. Inc.,
 Rt. 7, Danbury, Conn. 06813 / Page
 24 / Michel-Cather, Inc.

Randolph Computer Corp., 200 Park
 Ave., New York, N. Y. 10017 /
 Page 61 / Albert A. Kohler Co., Inc.

Scientific Control Corp., 14008 Dis-
 tribution Way, Dallas, Tex. 75234 /
 Page 9 / The Hal Mayer Co.

Univac, Div. of Sperry Rand, 1290
 Ave. of the Americas, New York,
 N. Y. 10019 / Page 71 / Daniel and
 Charles, Inc.

Varian Data Machines, 2722 Michel-
 son Dr., Irvine, Calif. 92664 /
 Page 72 / Durel Advertising

An aircraft carrier may be a very big ship but it's also a very small airport.

Over the past few years the Navy's planes have grown more and more complex. A lot more maintenance checks had to be made—and a lot more men and equipment were needed to make them.

All of which took more time and more space. The trouble is on an aircraft carrier you never have enough of either.

The advantage of UNIVAC® computer systems is they save on both.

The Navy worked with Univac engineers to develop a computer system that would check and troubleshoot equipment by zipping impulses through a plane's electronic package.

The system is called VAST—for Versatile Avionic Shop Test.

VAST will do routine aircraft maintenance in a fraction of the time taken by the equipment it replaces.

It will also take less than half the space.

It will cut down on the men needed by twenty-five percent.

VAST is easier to use so it will

be easier to train men to use it.

And it can be shared by six different repair crews at the same time.

Univac systems are at work in many fields. In industry, science, education and government.

On five continents.

And the seven seas.

UNIVAC

Univac is saving a lot of people a lot of time.

SPERRY RAND

Designate No. 17 on Reader Service Card

When it comes to expanding facilities, some airports are at a disadvantage.

So the Navy uses computer systems to keep its planes shipshape.

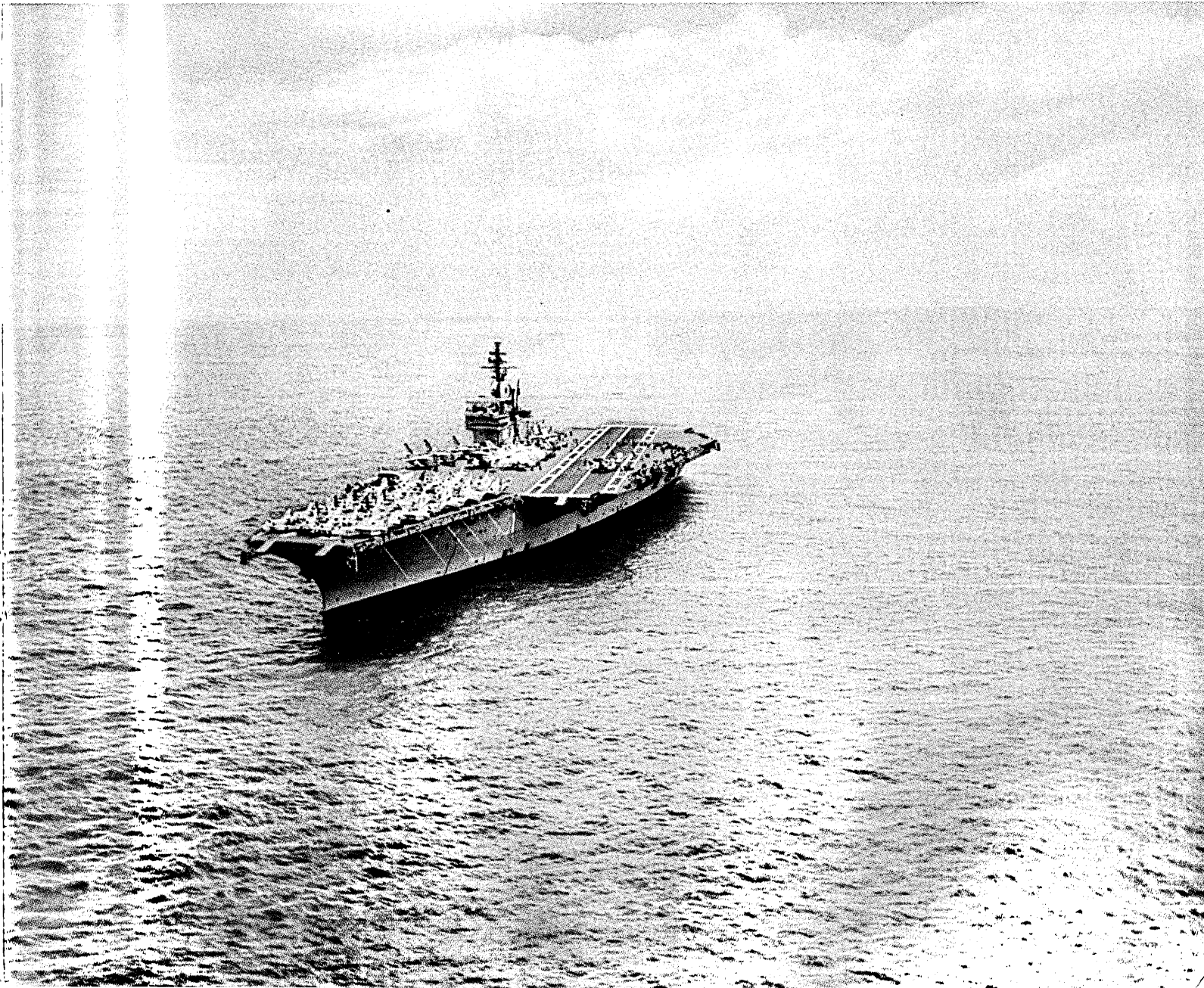

Whether you buy, lease or sell computer time:

If the **Varian Data** *mate* can't cut your turnaround time and deliver a better price/performance ratio...

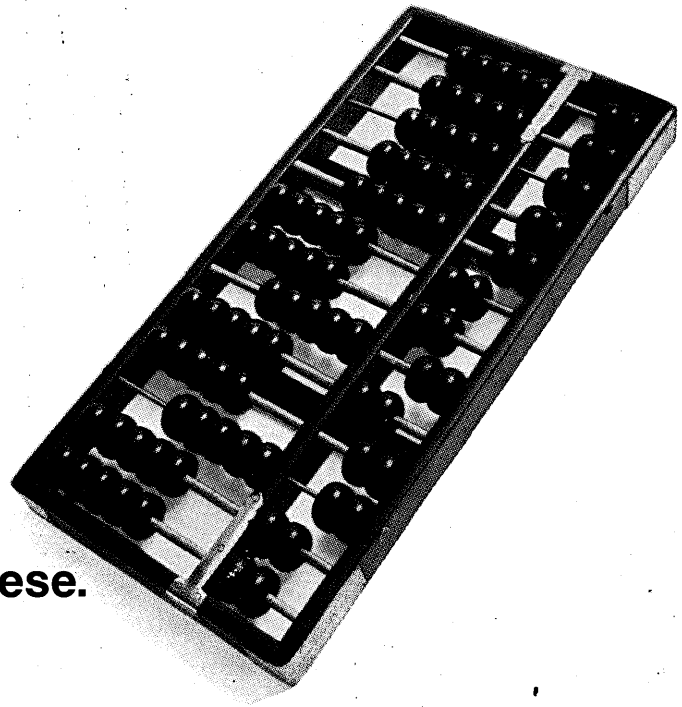

you must be using one of these.

Data-mate is Varian Data Machines' new Central + Remote Batch Terminal concept—a complete turnkey system that relieves large central processing computers

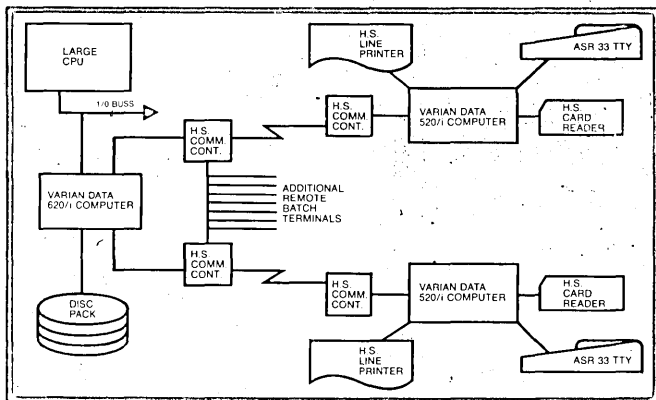

of nonproductive housekeeping duties...boosts the efficiency of a major computer installation by 40% or more ...enlarges computer capability without added computer investment.

Remote Batch Terminal: A Varian Data 520/i formats and compresses data, increasing line efficiency and transmission over duplex voice-grade telephone lines to the...

Central Batch Terminal: A Varian Data 620/i receives compressed data from remote terminals (up to 8 simultaneously), temporarily stores it, then feeds it to the C.P.U. in the optimum format and sequence. It's all done without major reprogramming of your present computer. Learn the whole bit about the Data-mate Concept—write for your brochure.

varian data machines



a varian subsidiary

2722 Michelson Drive/Irvine/California 92664

(714) 833-2400

Designate No. 16 on Reader Service Card

SALES OFFICES: U.S.: Santa Monica and San Francisco, California; Vernon and Westport, Connecticut; Chicago, Illinois; Houston, Texas; Fort Washington, Pennsylvania; Washington, D.C.; Walltham, Massachusetts; Fort Lauderdale, Florida. INTERNATIONAL: Australia, France, Germany, Sweden, Switzerland, United Kingdom, Ireland and Belgium.