

DATA MATION 61 N

January



Pages 8-16 The Path Ahead for Computing



TMI, THE LARGEST MANUFACTURER OF MEMORY PRODUCTS • FERRITE CORES • CORE ARRAYS • MEMORY STACKS • MEMORY SYSTEMS

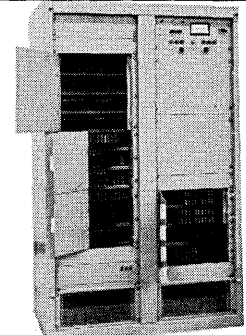
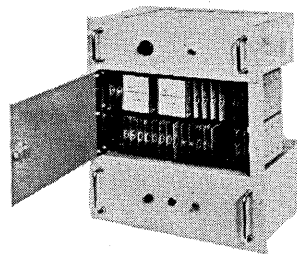
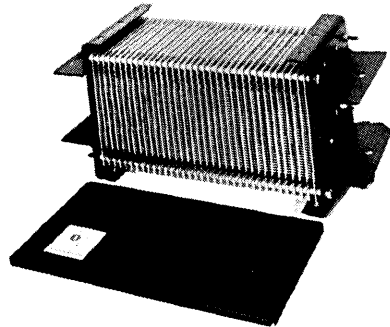
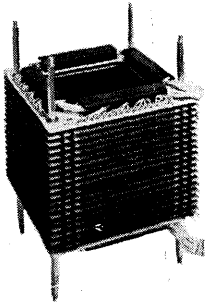
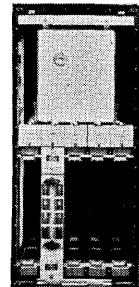
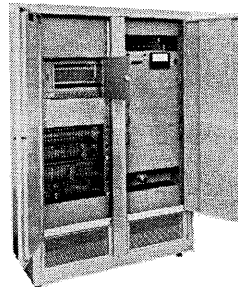
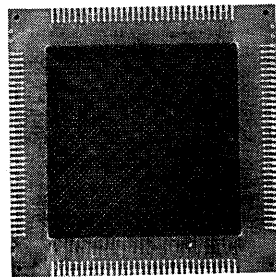
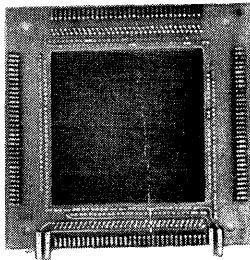
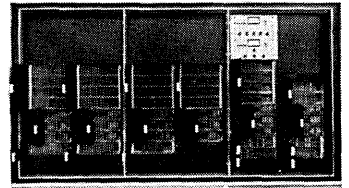
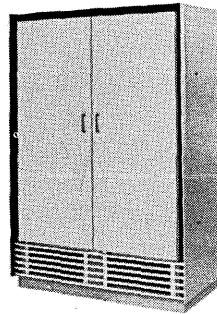
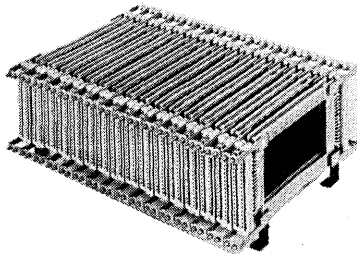
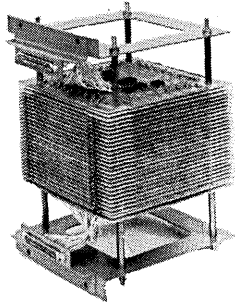
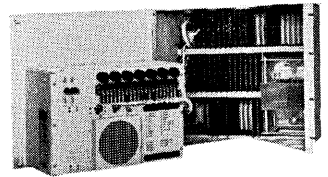
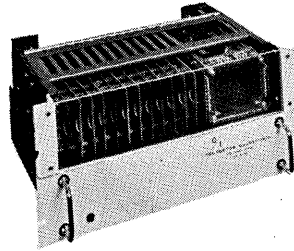
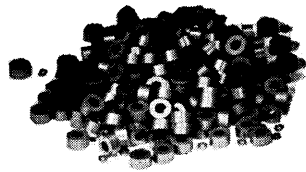
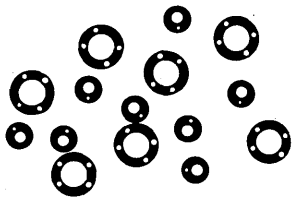

Since our engineers delivered the first commercial core memory in 1954, TMI has carefully created and built an integrated design, development, and manufacturing organization producing the only complete line of ferrite core memory products available. TMI sales engineers, conveniently located in field sales offices throughout the country, are anxious to help you with your digital storage problems, whether for 500 cores or 5 million cores, for a 500 bit buffer, or a 5 million bit memory, with operating speeds ranging from 50 milliseconds to one microsecond. Contact us for all your data storage needs.

TELETYPE MACHINE CO.

25000 Wilshire Blvd., Suite 1000, Beverly Hills, California 90210
 2125 Wilshire Blvd., Suite 1000, Beverly Hills, California 90210
 2125 Wilshire Blvd., Suite 1000, Beverly Hills, California 90210

Mathematical computation: vital element of Space Technology Leadership

The rapid solution of ever-more complex problems is indispensable in converting physical concepts into specifications for advanced space and ballistic missile systems. Space Technology Laboratories employs the modern, high-speed digital computer as an integral part of systems engineering. At STL's Computation and Data Reduction Center, computing specialists are daily expanding the wide potential of modern computing devices, as well as solving problems arising in advanced space technology. The Center, a modern, flexible facility, has a capability including two IBM 7090's and IBM 1401 auxiliary equipment. Continuing expansion of STL's activities in this vital area now creates the need for additional specialists with B.S., M.S., or Ph.D. in Mathematics, Engineering or the Physical Sciences, and related experience. Those capable of contributing within the environment of Space Technology Laboratories are invited to contact Dr. R. C. Potter, Manager of Professional Placement and Development. Their resumes and inquiries will receive meticulous attention.

SPACE TECHNOLOGY LABORATORIES, INC. P.O. BOX 95005Y, LOS ANGELES 45, CALIFORNIA

a subsidiary of Thompson Ramo Wooldridge Inc.

El Segundo • Santa Maria • Edwards Rocket Base • Canoga Park



Cape Canaveral • Manchester, England • Singapore • Hawaii

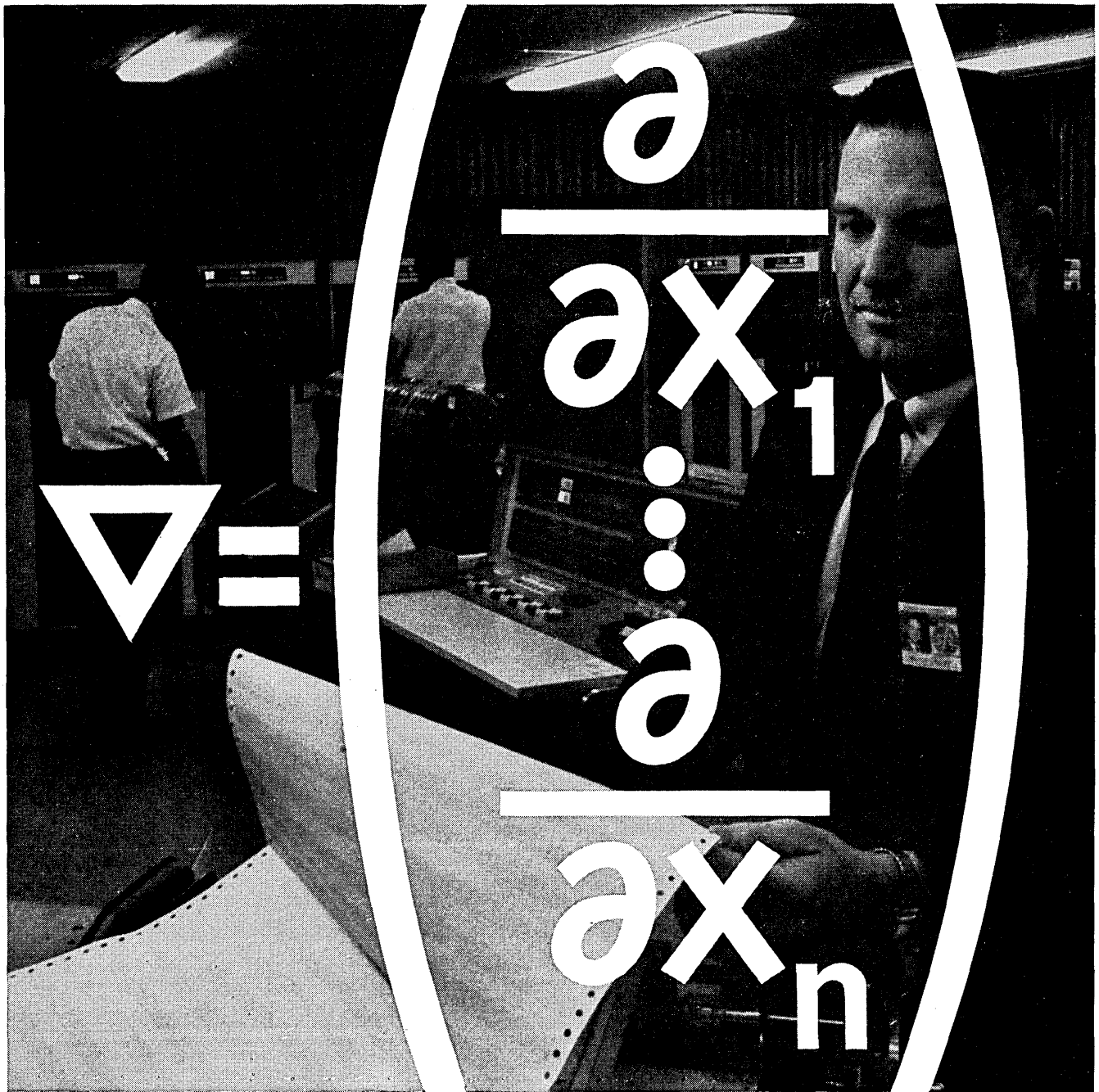

When responding, a mention of DATAMATION would be appreciated.

EVERYONE'S USING COMPUTERS...

| | | | | | | | | | | | | | | | | | | | | | | | | | | | | | | | | | | | | | | | | | | | | | | | | | | | | | | | | | | | | | | | | | | | | | | | | | | | | | | | | | | | | | | | | | | | | | | | | | | | | | | | | | | | | | | | | | | | | | | | | | | | | | | | | | | | | | | | | | | | |
|---|----|----|----|----|----|----|----|----|----|--|----|----|----|----|----|----|----|----|-----|--|-----|-----|-----|-----|-----|-----|-----|-----|-----|--|----|----|---|---|---|---|---|---|----|------------------|----|----|----|----|----|----|----|----|----|---------------------|----|--|----|----|----|----|----|----|-----|-----------|-----|-----|-----|-----|-----|-----|-----|-----|-----|-------|----|----|----|----|----|----|----|----|----|-------------------|----|----|----|----|----|----|--|--|--|-------------------|--|--|--|--|--|--|----|----|----|---------|----|----|----|----|----|----|----|----|----|------|----|----|----|----|----|----|----|----|----|-------|----|----|----|----|----|----|----|----|----|------|--|--|--|--|--|--|--|--|--|
| № детали или код сырья | | | | | | | | | | № детали или сырьин | | | | | | | | | | № клиента | | | | | | | | | | Отдел | | | | | | | | | | КОЛИЧЕСТВО | | | | | | | | | | Баланс | | | | | | | | | | Место | | | | | | | | | | | | | | | | | | | | | | | | | | | | | | | | | | | | | | | | | | | | | | | | | | | | | | | | | | | | | | | | | | | | | | | | | | | | | | | |
| Дата | | | | | | | | | | № заказа | | | | | | | | | | Для перфорации | | | | | | | | | | ИЗМЕНИТЬ | | | | | | | | | | | | | | | | | | | | | | | | | | | | | | | | | | | | | | | | | | | | | | | | | | | | | | | | | | | | | | | | | | | | | | | | | | | | | | | | | | | | | | | | | | | | | | | | | | | | | | | | | | | | | |
| Дата изъятия деталей | | | | | | | | | | <h3>ЗАКАЗ ДЕТАЛЕЙ</h3> <p>Коды незначительных сделок</p> <p>Первая литера</p> <p>0 - Для внутризаводской продукции</p> <p>1 - Для внутризаводской непродукции</p> <p>2 - Для других АВ БЭ Эм заводов</p> <p>3 - Для отделений</p> <p>4 - Для потребителей вне АВ БЭ Эм</p> <p>5 - Ключевая стоимость</p> <p>Итерная литера</p> <p>6 - Потребляемые детали</p> <p>9 - Неиспользуемые детали</p> | | | | | | | | | | <table border="1"> <tr><td>1</td><td>2</td><td>3</td><td>4</td><td>5</td><td>6</td><td>7</td><td>8</td><td>9</td><td>10</td><td>11</td><td>12</td><td>13</td><td>14</td><td>15</td><td>16</td><td>17</td><td>18</td><td>19</td><td>20</td><td>21</td><td>22</td></tr> </table> | | | | | | | | | | 1 | 2 | 3 | 4 | 5 | 6 | 7 | 8 | 9 | 10 | 11 | 12 | 13 | 14 | 15 | 16 | 17 | 18 | 19 | 20 | 21 | 22 | <table border="1"> <tr><td>23</td><td>24</td><td>25</td><td>26</td><td>27</td><td>28</td><td>29</td><td>30</td><td>31</td><td>32</td><td>33</td><td>34</td><td>35</td><td>36</td><td>37</td><td>38</td><td>39</td><td>40</td><td>41</td><td>42</td><td>43</td><td>44</td><td>45</td><td>46</td><td>47</td></tr> </table> | | | | | | | | | | 23 | 24 | 25 | 26 | 27 | 28 | 29 | 30 | 31 | 32 | 33 | 34 | 35 | 36 | 37 | 38 | 39 | 40 | 41 | 42 | 43 | 44 | 45 | 46 | 47 | <table border="1"> <tr><td>48</td><td>49</td><td>50</td><td>51</td><td>52</td><td>53</td><td>54</td><td>55</td><td>56</td><td>57</td><td>58</td><td>59</td><td>60</td><td>61</td><td>62</td><td>63</td><td>64</td><td>65</td><td>66</td><td>67</td><td>68</td><td>69</td><td>70</td><td>71</td><td>72</td><td>73</td><td>74</td><td>75</td><td>76</td><td>77</td><td>78</td><td>79</td><td>80</td></tr> </table> | | | | | | | | | | 48 | 49 | 50 | 51 | 52 | 53 | 54 | 55 | 56 | 57 | 58 | 59 | 60 | 61 | 62 | 63 | 64 | 65 | 66 | 67 | 68 | 69 | 70 | 71 | 72 | 73 | 74 | 75 | 76 | 77 | 78 | 79 | 80 | | | | | | | | | | |
| 1 | 2 | 3 | 4 | 5 | 6 | 7 | 8 | 9 | 10 | 11 | 12 | 13 | 14 | 15 | 16 | 17 | 18 | 19 | 20 | 21 | 22 | | | | | | | | | | | | | | | | | | | | | | | | | | | | | | | | | | | | | | | | | | | | | | | | | | | | | | | | | | | | | | | | | | | | | | | | | | | | | | | | | | | | | | | | | | | | | | | | | | | | | | | | | | | | | | | | | | | | | | |
| 23 | 24 | 25 | 26 | 27 | 28 | 29 | 30 | 31 | 32 | 33 | 34 | 35 | 36 | 37 | 38 | 39 | 40 | 41 | 42 | 43 | 44 | 45 | 46 | 47 | | | | | | | | | | | | | | | | | | | | | | | | | | | | | | | | | | | | | | | | | | | | | | | | | | | | | | | | | | | | | | | | | | | | | | | | | | | | | | | | | | | | | | | | | | | | | | | | | | | | | | | | | | | | | | | | | | | |
| 48 | 49 | 50 | 51 | 52 | 53 | 54 | 55 | 56 | 57 | 58 | 59 | 60 | 61 | 62 | 63 | 64 | 65 | 66 | 67 | 68 | 69 | 70 | 71 | 72 | 73 | 74 | 75 | 76 | 77 | 78 | 79 | 80 | | | | | | | | | | | | | | | | | | | | | | | | | | | | | | | | | | | | | | | | | | | | | | | | | | | | | | | | | | | | | | | | | | | | | | | | | | | | | | | | | | | | | | | | | | | | | | | | | | | | | | | | | | | |
| <p>Обозначено «Х» в соответствующем квадрате</p> <p>1 - Недоставок</p> <p>2 - Выполнено</p> <p>3 - Аннулировано</p> <p>4 - Перфорация</p> | | | | | | | | | | <h3>Коды оперативных счетов-для отчетных целей</h3> <p>Для нужд завода</p> <p>00 - Продуктивность</p> <p>10 - Непродуктивность</p> <p>11 - Газовый отлив</p> <p>12 - Сломанные детали</p> <p>13 - Сломанные и утерянные</p> <p>14 - Сломанные детали</p> <p>Другие АВ БЭ Эм заводы</p> <p>21 - Заготовительные детали</p> <p>22 - Производные детали</p> <p>23 - Производные АВ БЭ Эм Канада</p> <p>24 - Производные АВ БЭ Эм Канада</p> | | | | | | | | | | <p>Отправка в отделение</p> <p>31 - Списание</p> <p>32 - Исправление для тех. облуж</p> <p>33 - Промышленные</p> <p>34 - Части</p> <p>Заказчик вне АВ БЭ Эм</p> <p>41 - Продажи отгрузки</p> <p>42 - Заказчик у поставщика</p> <p>Процесс-обслуж</p> <p>60 -</p> | | | | | | | | | | <table border="1"> <tr><td>81</td><td>82</td><td>83</td><td>84</td><td>85</td><td>86</td><td>87</td><td>88</td><td>89</td><td>90</td><td>91</td><td>92</td><td>93</td><td>94</td><td>95</td><td>96</td><td>97</td><td>98</td><td>99</td><td>100</td><td>101</td><td>102</td><td>103</td><td>104</td><td>105</td><td>106</td><td>107</td><td>108</td><td>109</td><td>110</td></tr> </table> | | | | | | | | | | 81 | 82 | 83 | 84 | 85 | 86 | 87 | 88 | 89 | 90 | 91 | 92 | 93 | 94 | 95 | 96 | 97 | 98 | 99 | 100 | 101 | 102 | 103 | 104 | 105 | 106 | 107 | 108 | 109 | 110 | | | | | | | | | | | | | | | | | | | | | | | | | | | | | | | | | | | | | | | | | | | | | | | | | | | | | | | | | | | | | | | | | | | | | | |
| 81 | 82 | 83 | 84 | 85 | 86 | 87 | 88 | 89 | 90 | 91 | 92 | 93 | 94 | 95 | 96 | 97 | 98 | 99 | 100 | 101 | 102 | 103 | 104 | 105 | 106 | 107 | 108 | 109 | 110 | | | | | | | | | | | | | | | | | | | | | | | | | | | | | | | | | | | | | | | | | | | | | | | | | | | | | | | | | | | | | | | | | | | | | | | | | | | | | | | | | | | | | | | | | | | | | | | | | | | | | | | | | | | | | | |
| Код сырья | | | | | | | | | | Дата | | | | | | | | | | Коды операций | | | | | | | | | | Литера | | | | | | | | | | Проверочный счет | | | | | | | | | | № детали или сырьин | | | | | | | | | | № клиента | | | | | | | | | | Отдел | | | | | | | | | | Количество выдано | | | | | | | | | | Количество выдано | | | | | | | | | | Разница | | | | | | | | | | Опер | | | | | | | | | | Место | | | | | | | | | | Дата | | | | | | | | | |

BUT HOW MANY ARE USING THEM WELL?

The production potential of modern computing equipment is greater than ever. Yet, within most data processing installations are problems that go unsolved because of heavy routine work loads or shortages of specialized personnel. If this is true of your installation, there's a way to get more out of your computer investment. Use CSC to solve neglected problems and to augment your staff when the need arises.

Computer Sciences Corporation furnishes consultation, analysis, and programming in all areas of commercial and scientific data processing. Among CSC clients are such distinguished firms as Minneapolis-Honeywell, Sperry Rand, and Douglas Aircraft. CSC is also available to serve you, whether you manufacture, use, or should be using a computer. A telephone call or letter will bring to your office some of the top computer talent in the country.

For more information about the CSC approach to business and scientific problem-solving, write for the illustrated brochure, DA-1285-3.

- Analysis and Programming of Commercial and Scientific Applications
- Programming Systems
- Computer Research Projects
- Management and Staffing of Computer Installations
- Machine Feasibility Studies
- Contract Data Processing

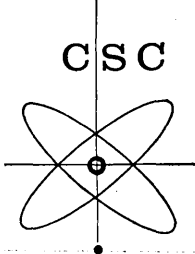

Challenging and rewarding positions exist at CSC for those who are outstanding in the computing and data processing field.

COMPUTER SCIENCES CORPORATION
 Malaga Cove Plaza, Palos Verdes, California

the automatic handling of information

volume 7, number

1

Staff

Publisher **FRANK D. THOMPSON**

Vice President & General Mgr.
GARDNER F. LANDON

Editor **SANTO A. LANZAROTTA**

Managing Ed. **HAROLD BERGSTEIN**

Assistant Ed. **G. PATRICK ANDERSON**

European Editor **ETIENNE J. GUERIN**

Contributing Ed. **DR. HERB GROSCH**

Technical Consultant **DON B. PRELL**

Production Mgr. & Art Director
CLEVE BOUTELL

Circulation Mgr. **MARTHA KNOWLES**

Editorial Advisers

DANIEL D. McCracken
C. L. WANLASS

Sales Mgr. & Eastern District Mgr.
RICHARD W. NIELSON
141 E. 44th St., New York 17, N. Y.
Murray Hill 7-5180

New England District Manager
WARREN A. TIBBETTS
434 Webster St., Manchester 4, N. H.
National 5-9498

Cleveland District Manager
ALBERT PUDVAN
3537 Lee Road, Shaker Heights 20, Ohio
WAshington 1-9370

Midwest District Manager
GILBERT THAYER

Midwest Representative
ROBERT W. HEATH
201 N. Wells St., Chicago 6, Ill.
Financial 6-1026

Western District Manager
HAMILTON S. STYRON
10373 W. Pico Blvd., Los Angeles 64, Cal.
BRadshaw 2-2643

European Manager
E. J. GUERIN
Box 824
Stockholm 1, Sweden

EDITORIAL OFFICES

10373 W. PICO BLVD.

LOS ANGELES 64, CALIF.

The Path Ahead For Computing

- 8 Introduction by *Frank Thompson*
- 9 The Human Side Of Computing by *Daniel D. McCracken*
- 11 Trends In Computer Hardware by *Graham Jones*
- 13 Trends In Programming Concepts by *Ascher Opler*
- 15 On New Areas Of Application by *Allen Newell*

Articles

- 35 Analyzing Election Computing 1960
- 36 RCA/NBC by *Sidney I. Newrith*
- 38 IBM/CBS by *Dr. C. Truman Hunter*
- 39 REMRAND/ABC by *Dr. Max A. Woodbury*
- 40 An Editorial by *Santo A. Lanzarotta*
- 42 RemRand Announces "Third Generation" 1107
by *Dr. H. R. J. Grosch*
- 44 New Computing Facility Combines Analog & Digital Techniques
by *Herbert Levy*
- 43 Russians Intensify Training In Computer Technology
- 43 "MIND" Announced by *Aeronutronic*

Departments

- 5 Datamation In Business and Science
- 17 Datamation News Briefs
- 32 People Moving Up In Datamation
- 48 New Products In Datamation
- 59 Datamation Abroad
- 62 New Datamation Literature
- 64 Advertisers' Index

THIS ISSUE—34,200 COPIES

DATA MATION 61

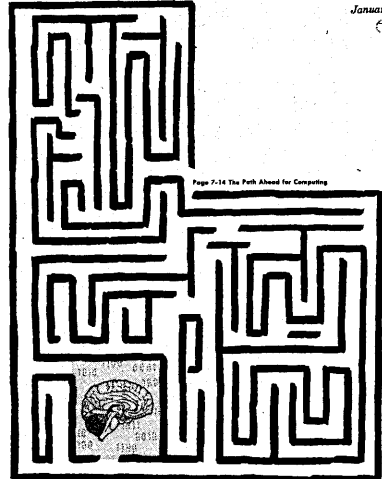

Cover

As the first presentation of what DATAMATION hopes will become an annual tradition in this journal, four prominent men in the computing profession have put together a progress report on information processing. Art for each of the editorials and the cover was prepared by Miss Cleve Boutell.

Circulation audited by
Business Publications Audit

Member, National
Business Publications



DATAMATION is circulated without charge by name and title to the manufacturers and users of automatic, information-handling equipment in all branches of business, industry, government and military installations. Qualified individuals in the United States and Canada are invited to request this publication on their company letterhead, stating position and firm's business. Available to others by subscription at the rate of \$10.00 annually; single issue, \$1.00 when available. No subscription agency is authorized by us to solicit or take orders for subscriptions in the United States, Canada or overseas.

COMPUTER GROWTH OPPORTUNITIES

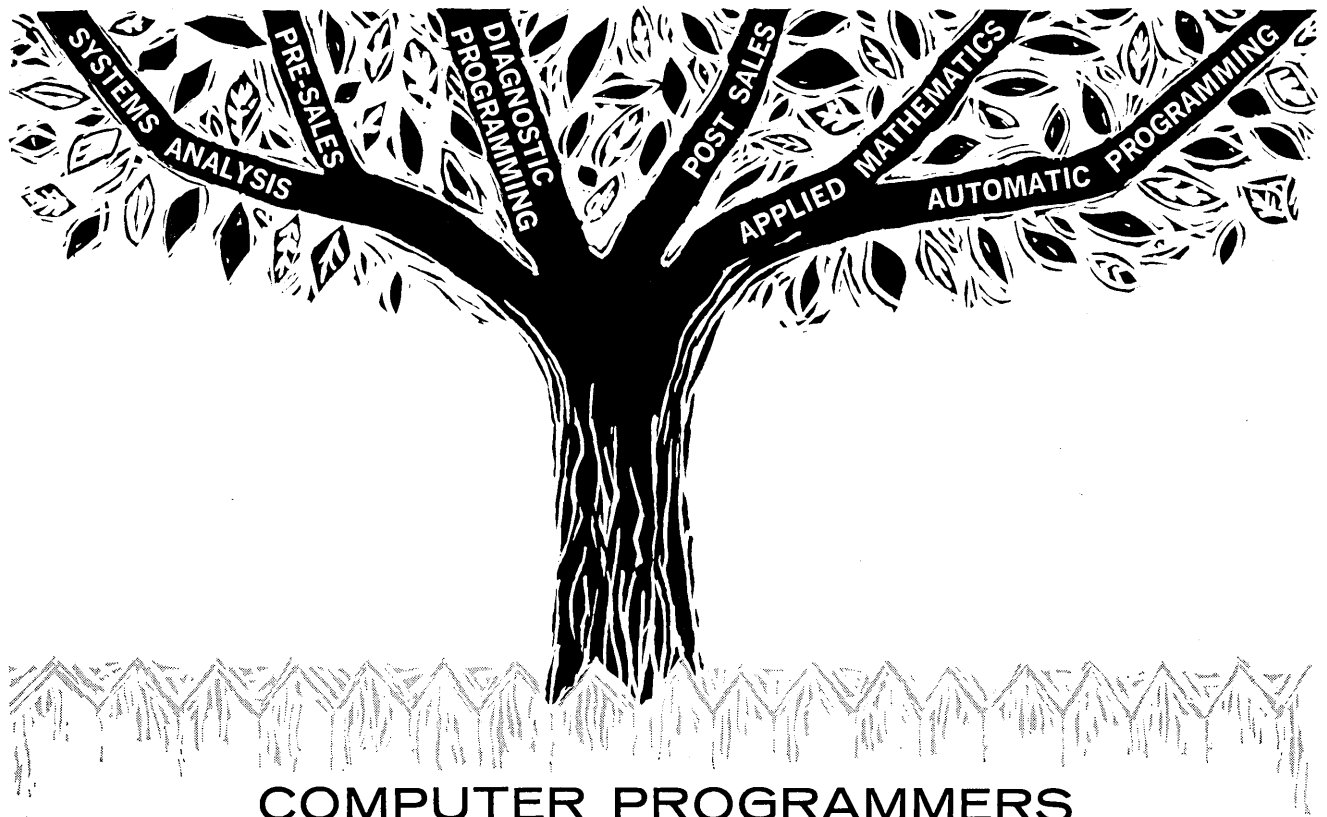

COMPUTER PROGRAMMERS

Our continuing growth is creating new positions for qualified programmers . . . a growth accelerated by recognition of individual achievement . . . a growth YOU can share. Persons who have written and debugged a variety of scientific and/or commercial programs on a large-scale binary computer are needed.

PHILCO offers a carefully expanding organization, educational program leading to advanced degrees, excellent facilities, equipment and atmosphere conducive to high levels of achievement.

New employees will receive a minimum of two months advanced training in the PHILCO 2000 system. Upon completion of the training program they should be available for assignment to a major metropolitan area. A relocation allowance is provided by the company.

If you are a mathematician, physicist or electronic engineer we invite you to investigate the opportunities as a Customer Service Representative. Inquiries are also invited from experienced Computer Sales Representatives, Systems Analysts and Field Engineers.

APPLY
Mr. John Felos
Professional Employment Mgr.
PHILCO COMPUTER DIV.
Willow Grove, Pa.

PHILCO®



Famous for Quality the World Over

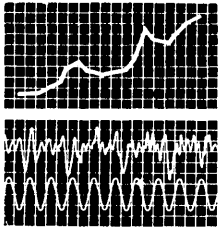

DATA in business and science

MACHINES, HERE AND DUE, MAKE NEWS

When they weren't talking about the weather or the unique accommodations provided by the New Yorker Hotel, those brave souls at the Eastern Joint Computer Conference were trying to top one another by displaying their knowledge of new machines -- announced or pending. Remington Rand had a do at St. Paul to unveil the 1107 a week before the show began (see page 42). Autonetics sent wires re the Re-comp III just prior to the show. The III is priced right (see next issue) and, despite the late hour, it might still give other small machine manufacturers something else to worry about. Philco missed the publicity boat by making too little of their new 2000 series -- the 210, 211 and 212 (familiar pattern?). The company says 212 is "seven times as fast as the 7090." Its main frame will sell for \$900,000 and rent for \$20,000 per mo. The 211 frame will rent for \$11,000 and the 210 frame for \$7,100. (More on the Philco line in February.) In the Whispering Machine Department, Burroughs is said to be ready to hatch (this month) its long-expected solid-state entry and Bendix may have something to talk about before the 31st. A men-from-boys weeding out process may be inevitable in the computer industry but it's interesting to note that the new machine curve seems to be going up, not down.

HONEYWELL ATMOSPHERE OPTIMISTIC

At the Minneapolis Honeywell Data Processing Division production site in Brighton near Boston, there are 10 Honeywell 800 central processors fully assembled and undergoing tests. In other parts of the plant, peripheral equipment to make these 800's complete systems are being readied for hook up. There are 20 800's in earlier stages of production at Brighton. The first system was to be delivered to Associated Hospital Service, N.Y.C., Dec. 20.

The atmosphere at Honeywell is clearly optimistic. Officials look forward to 1961 as a year when something close to 40 800's will roll off the line. They have supreme confidence that they are offering the best tape units (the only company in the field to unconditionally guarantee tapes), the best printers (Honeywell designed to operate at 900 lines per minute) and an attractive system rental (15 to 22 k).

At a press showing in late November, Honeywell engineers demonstrated capabilities of a prototype 800 with a stop-watch. In spite of the usual hitches associated with all demonstrations (such as forgetting to rewind tape before beginning a timing operation) all equipment operated at advertised speeds.

Company representatives spoke of \$60 million backlog of 800 and 400 orders. They predicted production of \$51 million in edp gear next year. They promised delivery of the FACT compiler to customers in February. They expressed confidence in the 800 algebraic compiler, ARGUS, and the 400 assembler, EASY.

Everyone touring Honeywell facilities on that cloudy

day in Boston came away with the feeling that the company has set its edp course and is underway at top speed. Only one small doubt remains in DATAMATION's mind. In response to a question regarding plans for new Honeywell computers, president Walter W. Finke remarked that the company has, of course, a full blown R/D effort under way. He added that, at the present time, there are no plans to produce a machine larger than the 800. Considering the vast potential of the computer industry, we wonder if any company can prosper in the long haul after placing such a restriction on its horizons.

GE FORMS
NEW PERIPHERAL GROUP

A new group in General Electric's Computer Department will be known as Peripheral Equipment Engineering. As the name implies and as a GE news release states, this group "will be responsible for developing all computer accessory equipment comprising integrated data processing systems." Listed among the equipment which would be GE-developed were magnetic character readers, sorters, encoders, printers and "such second generation devices as optical character recognition and thermoplastic tape systems." Organizing and staffing the new group is manager Kenzel P. Manning. This latest GE announcement may be another indication that the sleeper in the computer field is stirring.

RCA OFFERS
NEW EDP LEASING PLAN

RCA has announced a new leasing plan which, in our opinion, they justifiably describe as "a major departure from the conventional rental systems now in effect in the data processing industry." The new plan will apply to all 601, 501 and 301 systems. The lease arrangements set basic monthly charges for different combinations of work requirements and are designated (1) unlimited availability (2) extended availability (3) random use and (4) single shift availability.

Unlimited availability: operation of the equipment seven days a week, other than time needed for maintenance, is provided by this plan which affords savings for customers operating the system in excess of two personnel shifts a day. There is a basic monthly charge of 30 per cent over the single shift rental.

Extended availability: This provides up to 24 hours a day, five days a week, other than time needed for maintenance, for a charge of 20 per cent over the single shift rental. It also can be used the other two days for a prorated charge on the same basis. This plan provides savings for the customer operating more than 1½ shifts per day.

Random use: This entitles the customer to a maximum of 200 hours, at his option, in each calendar month at a basic charge of 3 per cent over the single shift rental.

Single shift availability: This is the standard rental for RCA systems, covering a primary shift of eight consecutive hours per day, five consecutive days a week, designated at the customer's option.

CSC ASSIGNED
REMRAND, DOUGLAS PROJECTS

Computer Sciences Corp. is designing an algebraic compiler for LARC. The project will take 15 months to complete. CSC, which recently moved to Palos Verdes from Inglewood, Calif., has also signed a contract with Douglas Aircraft to produce a simulated program for the 7090 which will allow that computer to process 701 programs

The Honeywell Word:

How it contributes to the flexibility and efficiency of Honeywell EDP Systems

The basic unit of information in Honeywell Electronic Data Processing Systems is the Honeywell Word. The Honeywell Word contains 48 bits representing information, plus additional bits for checking purposes.

Though the checking function is an important feature, this discussion is primarily concerned with the 48-bit information portion of the word.

This 48-bit portion is extremely versatile. As a data word, it may represent information in the form of decimal or binary numbers, alphabetic characters or special symbols. As an instruction word, it causes the System to carry out specific data processing functions.

Data Let's look at data words first. Honeywell Systems can **words** treat a word as a pure binary number consisting of a sign and 44 bits, or 48 bits without a sign (a positive sign is normally represented by four binary ones and a negative sign by four binary zeros).

| DATA WORDS | | | | | | | | | | | | |
|--------------------------------------|---------|-------------------------------|---|---|--------------------------------|---|---|---|---|---|---|---|
| TYPE | EXAMPLE | | | | | | | | | | | |
| DECIMAL | ± | 0 | 9 | 8 | 7 | 6 | 5 | 4 | 3 | 2 | 1 | 0 |
| ALPHANUMERIC | R | O | B | I | N | S | O | N | | | | |
| COMBINATION DECIMAL AND ALPHANUMERIC | 1 | 7 | 4 | P | A | R | K | | | | | A |
| BINARY | ± | (44 Binary digits) | | | | | | | | | | |
| FLOATING POINT | ± | EXPONENT (7 Binary Digits) | | | MANTISSA (40 Binary Digits) | | | | | | | |

The 48 bits may be considered as four-bit groups representing decimal information. Hence a word may contain 12 decimal digits or 11 digits plus a sign. Extensive analysis of commercial data helped to determine the size of the Honeywell Word. A curve showing the frequency of use of numbers of various sizes indicates 10 to 11-digit numbers as being most common. In the economics of computer design, a word containing 11 digits (plus sign) is thus of optimum size.

Alphanumeric information takes the form of six-bit groups, resulting in as many as eight alphabetic (or six-bit numeric) characters in a word. Four-bit and six-bit groups, incidentally, can be combined in a word. In addition, Honeywell 800 has optional floating-point arithmetic logic wherein the 48-bit word is treated as a 40-bit mantissa, a seven-bit exponent and a one-bit sign. The floating-point option includes both binary and decimal arithmetic.

Instruction Three-address instruction logic, because of its **words** speed and programming advantages, is standard in Honeywell EDP Systems. Honeywell instruction words are interpreted fundamentally as four groups of 12 bits each. The first group represents a command code or function to be performed. The remaining three groups represent address groups normally used to designate the location of operands and results. In certain instructions, however, they may contain special information — such as the number of data words to be transferred, the number of decimal or binary digits to be shifted, or the number of words to be edited.

| INSTRUCTION WORD | | | |
|------------------|-----------|-----------|-----------|
| OPERATION CODE | ADDRESS A | ADDRESS B | ADDRESS C |
| 12 Bits | 12 Bits | 12 Bits | 12 Bits |

Programming Exceptional programming flexibility is **flexibility** achieved in several ways. One of these is the ability to specify the location of data relative to other data without relying on specific or absolute addresses (indexing). Masking permits the selection and manipulation of information units smaller than a word. A special type of instruction called a Simulator Instruction permits any routine to be treated as if it were a built-in instruction.

Orthotronic Still another special word in the Honeywell **control** System vocabulary is called an Ortho word. Ortho words are generated by the System and appended to the end of each record as it is recorded on magnetic tape. Unique to Honeywell Systems, these Ortho words are an automatically generated mathematical image of the information in the record. If portions of the record should—for any reason—be unreadable at some later time, Orthotronic control not only assures detection, but permits the original information to be reconstructed by the system.

Get the The flexibility and efficiency of the Honeywell **whole story** word are indicative of the many advances in logic and engineering that are typical of Honeywell equipment. To get full descriptive information on either or both Honeywell 800 and Honeywell 400 Transistorized Data Processing Systems, just write: Honeywell Electronic Data Processing Division, Wellesley Hills 81, Massachusetts.

Honeywell



Electronic Data Processing

CIRCLE 5 ON READER CARD

THE PATH AHEAD FOR COMPUTING

On the next eight pages, DATAMATION presents the expert opinions of four prominent men in the information processing field concerning the path ahead for computing. These pieces are offered as representative statements of the present and future trends in such areas as staffing, programming, hardware and applications. The writers paint a picture of a profession which is at once fraught with problems and filled with opportunity.

How are we to react to the unique experience of adjusting to a professional population explosion while facing an acute scarcity of computer personnel? Will enough qualified programmers be found to cope with the new machines and will the programming community be able to adjust to a necessarily changing machine environment? Will machine designers be able to build systems incorporating increased reliability and economy to match advances made in machine speed? Will analysts and engineers uncover and develop the many potential areas of new application?

These questions are answered in part on the following pages. They will be answered fully in time.

We are deeply grateful to Messrs. Newell, Jones, Opler and McCracken for their thoughtful presentations. We can think of no better way to launch our journal on its new schedule of monthly publication.



FRANK D. THOMPSON
Publisher

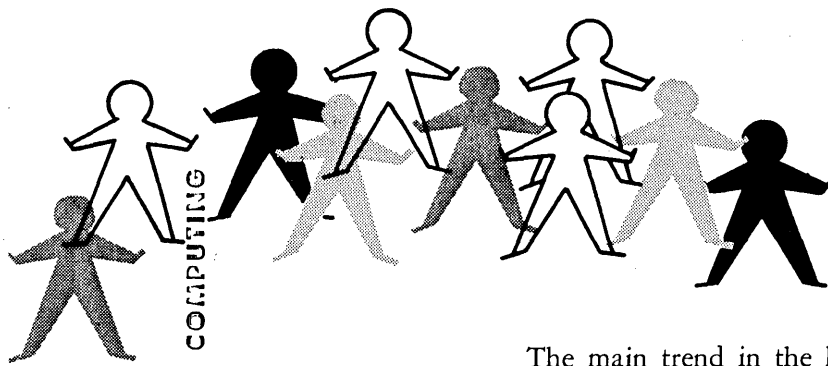

THE PATH AHEAD FOR COMPUTING

The main trend in the human side of computing is the explosion in the number of humans. A decade ago there were probably not a hundred programmers in the world; today there are several companies with close to a thousand programmers each. Just as significant, there are dozens of companies which three years ago had little idea of ever getting a computer; today they have a small machine

THE HUMAN SIDE OF COMPUTING

by Daniel D. McCracken

on order and ten people ready to go to programming school. A quick calculation indicates that just the machines now on order will require the training of perhaps 20,000 new full-time programmers.

This growth has several implications. First, a sizable fraction of the people now in computing will be devoting much of their time in the years ahead to training new programmers, applications specialists, designers, production workers, and maintenance men. Second, there is going to be more work than can be done by full-time employees of the users of the computers. Manufacturers, consultants, and job-shoppers will have to fill the gap. Third, there will have to be continuing efforts to simplify the work of busy humans, in order to keep up with the flood of new computers. Things like design automation techniques and problem-oriented-language compilers will be even more essential than they are now.

A few people worry that this automation of automation will lead to technological unemployment within the industry. It seems most unlikely, however, in view of the amount of work to be done, that any programmers will be thrown out of work by FORTRAN or COBOL. Besides that, it is going to take hundreds of people to write and maintain the compilers—although some retraining may be required. The same goes for designers and production workers.

The training of hordes of newcomers isn't the whole story, of course. There are problems in the professional development for those already in the field, too. To take one instance, a lot of the present coders will have to become systems analysts in the next few years. The problem is, how are they supposed to go about learning the new skills required?

This is perhaps typical of one of the largest personnel problems facing the industry. There are coding courses by the hundreds for the beginner, but where are the systems design courses for the coder? The difficulty seems to be that systems work is not so much a body of factual knowledge, as an approach to problem solving—



McCracken

and no one knows how to teach the problem solving approach. All that we seem able to do is let the coder work with an experienced systems man, and hope that some of the skills get transferred by osmosis.

The question of how coders become system designers can be posed in much broader terms. Naturally, the same sort of consideration applies to the technician who wants to become an engineer and the engineer who wants to become an engineering manager. The ambitious individual can do a lot by the usual attacks: night courses, transfers that broaden his background, etc. With the tremendous demand for qualified people, we should see a great deal of this sort of personnel development in the industry in the years to come.

Beyond that, however, there remains the nebulous question of "professional recognition." This observer would like to suggest that the attainment of truly professional status for computer people as computer people is only partly a matter of demonstrating mastery of subject matter. It is also a matter of demonstrating a sense of responsibility and thereby gaining a certain dignity and stature in the public eye.

This latter will not happen as long as too many of us remain so engrossed in technical work that we slight our community responsibilities. It will not happen as long as the computer industry has no organized program of public education, such as the American Chemical Society carries out. It will not happen as long as 95% of the public visualizes a computer in terms of a TV commentator on election night saying, "The computer now believes the odds are. . . ." Perhaps most important, it will not happen as long as anyone with ten dollars can join the ACM and proclaim himself a professional computer expert. One of the universal marks of every profession is an accreditation procedure to guarantee the public a minimum level of competence in anyone who is permitted to claim membership in the profession.

A computer industry equivalent of the Bar Association would admittedly be difficult to set up, and maybe the time isn't ripe yet. A timely step in the right direction would be the establishment of a Senior Member classification in the ACM and other similar groups. The stringent admission requirements that would be worked out, and the admission procedure itself, could later become the framework for the creation of a real Computer Profession.

The fact is, then, that we face many serious human problems, as well as technical ones. We must prepare for an intensive education effort. We must somehow learn to communicate advanced concepts and approaches to beginners. We must learn to get our work across to the public better. All of this boils down to communication, which should be no surprise; every other profession faces the same problem, as does the human race. Our problem is more severe because we are a young profession and because we are growing at a fantastic rate.

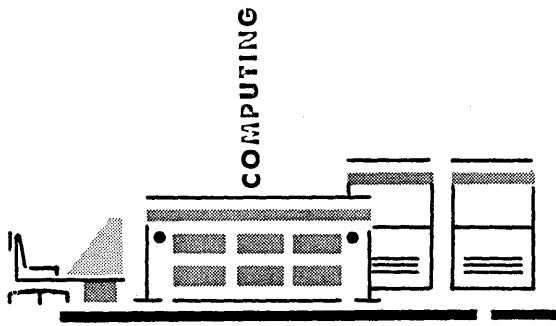

THE PATH AHEAD FOR



Eight short years have passed since the first commercially available data processing system made its television debut to predict the election victory of President Eisenhower. Had that machine been running continuously from that day to this, today's fastest equipment could repeat the entire eight years' computing in only 24 hours.

Speed has been the consuming passion of the first eight years of commercial computing. Circuit and memory speeds have increased by several orders of magnitude.

Such logical devices as indexing, repeat commands, edit commands, and floating point arithmetic have been incorporated to increase the speed of different types of programs. Buffering schemes have become mandatory, insuring that the computer shall not waste time waiting for the mechanics of input-output devices. Now we are squeezing out still more speed through the sophisticated logic of multiplexing busses driving several overlapped memories, "look-ahead" registers, and asynchronous timing schemes.

Speed has found a ready market. As the cost of data processing systems has increased, the cost per operation has dropped sharply,

TRENDS IN COMPUTER HARDWARE

by Graham Jones

and the additional capacity of each new system has been quickly consumed. We remember the wistful complaint of a computing center manager a few years ago, who was unable to find any 7-cycle logarithmic graph paper on which to project the growth of his installation in computing capacity. The 5-cycle paper available to him, he told us, was inadequate for proper planning.

Our friend no longer has this problem. The transient surge of growth in his and other installations is beginning to settle out. The potential for growth is still immense, and the need for speed remains important, but it is no longer paramount. Other improvements are increasingly important in realizing the potential for growth.

The most interesting improvements in computers over the next few years will probably be *tours de force* of ingenuity which we will not attempt to predict. The most predictable improvements, which we shall mention here concern reliability, economy, and an increased use of communication facilities for direct input-output.

Reliability is one of the toughest problems facing the industry, and will receive growing attention in the next few years. Solid-state electronics has already alleviated this problem to the point where component failures are rare, and long runs can be made on a system with high confidence of successful completion. We are now faced, however, with real-time applications in which a few minutes of systems failure can be catastrophic. Commercially available computers are still subject to such failure, so that it is reliability rather than speed which is the limiting factor in these cases. Contracts have been let for some special-purpose high-reliability systems, and in each case the contractor must design for complete backup facilities in the event of failure of any unit. This involves heavy expenditure, and does not always provide protection against system failure. Catastrophic failure is rare indeed in such a complex system as a telephone exchange, yet the failure of one component will usually



Jones

TRENDS IN COMPUTER HARDWARE

take a computer right "off the air." This problem is rarely serious in batch processing, but for real-time work we must achieve systems whose units can be maintained with no worse effect than some performance degradation. The significant report eight years hence must be not that we can do eight years' work in a day, but that systems can run for eight years with only a day of down time.

Data processing systems are expensive, and the growth potential for our industry is clearly dependent on the economies we achieve at all performance levels, not just the highest. Complexity is here to stay. Economy must be achieved through mass production and automatic manufacture of intrinsically complex devices. We have already achieved a high degree of automation in the manufacture of components and their insertion into printed circuit cards, and in the wiring of panels from machine-generated wiring lists. Soon we shall see multi-element components in the same container, and eventually whole sections of logic manufactured as one piece-part. Thin magnetic films and cryogenic devices offer similar advantages for manufacture.

The component area of the industry, then, is becoming more and more sensitive to the requirements of the factory to bring us more economical equipment. Today our technology is changing so rapidly that it is hard to reach the volume that brings economy on one device before it is replaced by an improvement.

Input-output devices are still plagued by the problems of mechanics. They have the distinction of showing less progress and less promise than any other area of the business. Non-mechanical printers have met with mixed success. Character-sensing is steadily advancing, but is an inherently complex process. Some encouragement is offered in high-density recording on magnetic surfaces which will soon bring us appreciable improvements in magnetic tapes and considerable advancement in disks and drums. The inevitable conclusion is that we must reduce the number of transcriptions of data from one medium to another, which is but one of several reasons why direct telecommunications to and from computers is the fastest-growing development in input-output. This technique will, however, require economical equipment for terminals and displays.

Developments in machine logic do not promise any outstanding surprises. Such changes as can be expected will be aimed to facilitate handling of features already described. Programmed diagnosis of faults, for example, will require special logical arrangements. The sequencing of message-handling and the assignment of memory areas in systems which handle several applications, offer challenging problems to the machine designer. If a system must continue to operate while one of its units is out of order, the system logic must allow the programmer to anticipate such failures.

The most significant trends we see are not only somewhat faster hardware but significantly more reliable and economical hardware. These qualities will be married with large-volume stores and communication networks to equip us for an effective attack on real-time applications. Thus, we shall remove the major constraints which are holding back application designers in putting their ingenuity into practice.

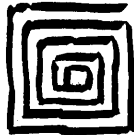

THE PATH AHEAD FOR COMPUTING

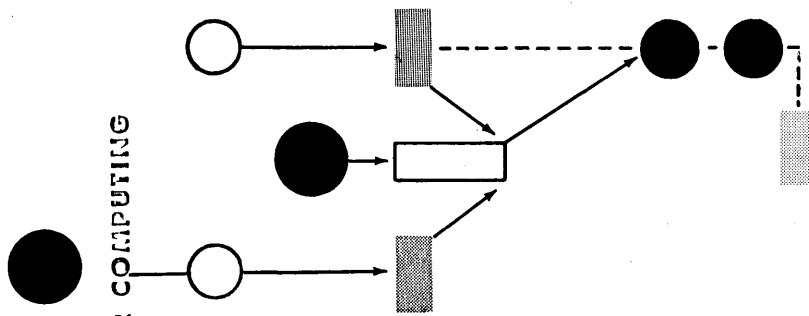

The professional programmer finds himself in a period of unprecedented growth. Although the history of computer programming is relatively brief, never has the programmer had to cope with as many changes and adjustments as are facing him in this decade.

We are in a period marked by (1) extremely rapid growth, (2) the awareness that there will be series of transitions from machine

TRENDS IN PROGRAMMING CONCEPTS

by Ascher Opler

N to machine $N + 1$ and (3) the traumatic change from experimenting in a novel electronic laboratory to working with an operating department of a big organization.

So great are the needs in the programming area that most professional programmers with good background and experience find themselves involved in system programming. That is, the programmer finds the largest percentage of his time is devoted to devising methods to enable the less experienced to translate from problem to program rapidly and to make the most effective use of the computing equipment available.

The three most obvious facts staring at the programming profession today are these:

1. There not only are not enough qualified programmers today but it is becoming evident that the "programmer gap" is not likely to ever be filled.

2. While computer manufacturers are far from emulating the practices of the automobile industry, those who are just acquiring their second or perhaps third successor computer are beginning to realize that there will no doubt be a sixth and seventh and eighth too. And, to complicate the picture, within the life of a single computer, it may grow through a series of modular increments by acquiring additional fast storage, magnetic tape units, random access processors, etc.

3. Because of the mounting requirements of the field and the long recognized clumsiness of console manipulation, the transition to machine environments completely dominated by an *operations staff* rather than by a *programming staff* is at hand. The day of programmer operating and debugging is rapidly fading. Not only must the programmer stay out of the machine room, but he must now



adapt his programs to the common good of the installation as determined by the operational group.

To meet the problems posed by the foregoing, a number of solutions have been developed and put to good use. The general technique of automatic programming has been known for several years. However, in the present crisis, considerably increased attention is being given to the development of highly polished automatic programming languages and systems, especially along the lines of source language compilers. Very sophisticated assembly systems, debugging systems, operating systems, simulators and translators are being developed to meet the ever-mounting need for better tools.

Out of this welter of transitions has come the strong cry for compatibility. Since it is becoming virtually impossible to obtain hardware compatibility (*retrospective* with former equipment, *concurrent* with different species of machines, and *future* with possible successor computers) increased attention is being given to programming language standardization. Out of the current period, there is emerging considerable support for standardizing on current versions of ALGOL and COBOL. However, at this date, there is most compatibility between machines which accept the Fortran language than any other. The transition from acceptance of Fortran to acceptance of ALGOL must take place in the next couple of years.

One of our biggest headaches is that involved in minimizing the programming effort for all of the compilers needed to compile from all acceptable source languages to the various existing machines of all species and all configurations. Work is going forward on at least three proposed solutions (compiling of compilers, universal computer oriented language (UNCOL) and direct translation). This is an important problem that must be solved. To date, none of the proposed methods has fully succeeded.

Other problems that must be solved involve communication and inter-computer problems. Among these are the effective use of the multi-programming facilities provided in many new machines, the integration of large computers with smaller satellite computers, truly remote operation of a single computer and remote communications from computer to computer. While there is considerable activity in all these areas as present, what is required is a real integration with our present computer activities and a full exploitation of the possibilities.

These are certainly exciting days for those who accept the challenge of computer programming. Perhaps Carlyle's remark about the French Revolution might be quoted "Grand it was in that dawn to be alive, but to be young was very heaven."

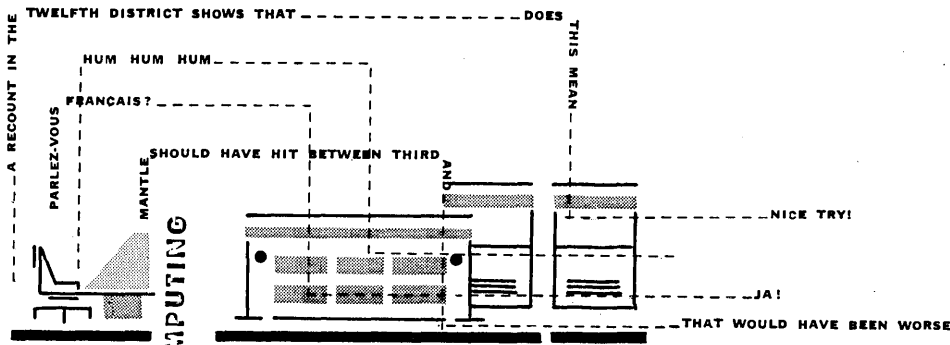

THE PATH AHEAD FOR COMPUTING

The population of computer applications behaves in many ways like a population of evolving organisms. It grows continually, even exponentially. This growth is autonomous—the natural product of a vigorous segment of the economy and culture. Variation is mostly by combinations of features already existing in the population. It occurs continually because our professional orientation is toward

ON NEW AREAS OF APPLICATION

by Allen Newell

exploiting the new technology. Improvement and innovation are not only economic necessities of the computer industry, but provide the programmer and engineer some measure of intrinsic satisfaction from their work. Selection of the fittest is easily documented.

According to theory, successful branches of an evolutionary tree undergo adaptive radiation, fanning out to occupy all available environmental situations which can support some variant. Applied to computers this means that any application you can imagine will eventually occur. Many applications will not prove successful, but every environmental niche in which information technology can be used will be occupied, to be reoccupied by more successful processes or abandoned if economically too inhospitable. This evolution, like biological evolution, will appear highly extravagant and wasteful. However, in the long run it may yield highly satisfactory results, far in excess of those obtainable in an environment so harsh that success must be assured before an application is born.

The current range of applications suggests no other pattern. Engineering calculation and business data processing do constitute continuing mainstreams. But the range is much broader: preparation of Bible concordances, prediction of election returns, discovery of new chemical names, composition of elementary music, solution of double-crostics—even a program that plays solitaire. Seemingly esoteric, these provide much of the variation from which the next generation of more practical programs will come.

The far future is then too easy to predict. More intriguing is the immediate course of evolution (a task the biologist sensibly tries to avoid). It is an entirely local consideration, like the kids' game of guessing how runoff from a sprinkler will spread over a cracked sidewalk. Nutrient environments such as nuclear energy practically guarantee adaptation in the direction necessary to fit into them. Thus



Newell

the ability to handle large hydrodynamic problems has been a strong guide in the most advanced generation of computers. Barriers force compensating developments. We cannot yet recognize the printed word directly, so a great proliferation has occurred in punched card devices.

A fascinating possibility is the handling of raw language. Ordinary human technical prose is much too variable, too prone to error, and too convoluted for current computers. We cannot instruct them easily; we cannot even give them data without careful preparation. They cannot even comprehend an ordinary bibliographic citation or a function table in an ordinary reference.

A measure of this barrier is the now complete destruction of the myth that computers are easy to use. Getting anything into a computer is tolerated only because of the very large gains that come from mass processing of information. Removing this barrier might well mark the shift from burden to ease in the use of computers. Besides transforming many applications already made, it would open a host of new ones, such as real time executive decision making.

My interest is compelled not only by the opportunities if the mutation could ever occur, but by the indications of its possibility. Three major ingredients seem required, each of which seems already well advanced in separate branches of the evolutionary tree. First, by any reckoning large quantities of information must be accessible if arbitrary statements in technical language are admissible. Concern with information retrieval has already spurred development of large stores and provided experience with indexing and accession schemes. Second, basic techniques for recognizing and manipulating the structures implied in free language are required—e.g., parsing sentences. Mechanical translation, faced with the same need, has gone a long way toward meeting it. In retrospect this may prove its most vital contribution. Finally, the sophistication necessary to extract the meaning from expressions—to recognize the intent of the writer—is needed. Here there has been twofold preparation: the programs for interpreting increasingly complex languages like ALGOL and COBOL; and the programs for solving problems by heuristic methods in elementary theorem proving and game playing. These parts combine to yield a problem solving interpreter working from a cleaned-up version of the input expression into a model of the things the writer might intend.

Given the evolving nature of information processing, elementary language-understanding programs will eventually exist. Whether they will maintain a foothold in economic competition with humans is an entirely different question. I already know of three efforts to pass beyond mere language data processing to language interpretation: a program to converse about baseball; a program to assimilate information from Basic English; and a program to do word problems in elementary algebra. Undoubtedly there are others. These serve as cues that the combination is beginning.

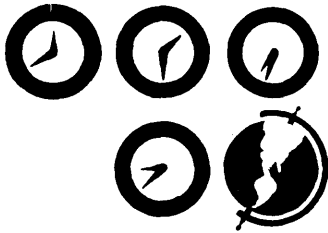

DATAMATION *news briefs*

COLLINS RADIO ANNOUNCES DATA PROCESSING DIVISION

A communication and Data Processing Division has been formed by Collins Radio Company in Cedar Rapids, Iowa. Two IBM 7090's have been installed in the new facility. The system's first link — Collins' subsidiary plant at Toronto with the Central Data Processing Center at Cedar Rapids — has been completed and is in operation. A \$1-million building to house the center is nearing completion. Additional communication links with the center are being made to subscriber stations at Los Angeles, Dallas, Washington, New York and Kansas City. The new division will sell its services on a subscriber basis; sell or lease the new Collins equipment, or provide complete private communication and data processing systems tailored to the needs of the customer.

CIRCLE 100 ON READER CARD

C-E-I-R, DATA-TECH MERGE; WILL OPERATE 501 IN N.E.

C-E-I-R, Inc. has signed a contract providing for an economic merger with DATA-TECH Corp. of Hartford, Conn. The firm specializes in electronic data processing services for the New England area. DATA-TECH's operations began in 1960 and the company has about sixty employees working on its present contracts, with a current sales volume of approximately \$300,000 a year.

In the spring of 1961, the company will operate an RCA 501 located in the Connecticut General Life Insur-

ance Co. Building in Hartford. DATA-TECH recently designed and programmed the first Motor Vehicle Registration program for the state of Connecticut. It also has an exclusive utilization contract for a 501 system in Hartford, with Connecticut General.

CIRCLE 115 ON READER CARD

BANKERS INVEST IN NDP, PRES. PHILIPSON REPORTS

A group of prominent investment banking firms have made an investment in National Data Processing Corp. Herman L. Philipson, Jr., president of the Dallas manufacturer of bank automation and optical scanning equipment, stated that Carl M. Loeb, Rhoades & Co., Wertheim & Co.; Lehman Brothers; Bear, Stearns & Co.; and First Southwest Company are included in the banking group. Equipment currently being sold by NDP includes magnetic ink character recognition equipment developed originally for the Federal Reserve System and optical scanning equipment for the automation of credit card billing systems.

ALCOA GETS DATA CONVERTER

Digitronics Corporation has delivered a specially designed data converter to the Wear-Ever Aluminum Co., a subsidiary of the Aluminum Company of America. The converter, which functions at speeds of 3,000 words per minute, has been designated the model DI05. Before Alcoa accepted the converter, it was subjected to extensive tests.

CIRCLE 101 ON READER CARD

BENDIX COMPUTER ANNOUNCES FASTER SPEEDS FOR G-20

A 40 per cent increase in computing speed of the Bendix G-20 computing system has been achieved, that company announces. The full-word clock cycle time of the G-20 has been reduced to 6 microseconds. Average rate for single word, fixed point additions is now 83,000 per second. In addition magnetic tape speeds in it have been doubled. Reading and writing operations are now performed at 240,000 digits or 120,000 alphanumeric characters per second. Searching is performed at double these speeds.

CIRCLE 102 ON READER CARD

EDP CORP. DEVELOPS METHOD TO STORE ANALOG INFO

The E D P Corporation has developed a new technique for storing analog information. The technique uses an electronic memory cell as a non-destructive, non-mechanical method of storage for analog information. It has permanent storage capabilities and can read over and over again, contrary to other methods which do not have suitable provisions for electronic read-out. This new technique has the advantage that the signal recording does not require mechanical parts that are subject to problem.

CIRCLE 116 ON READER CARD

ELECTRONIC ASSOCIATES NAB POLARIS ANALOG CONTRACT

A contract to produce a large-scale, three-console analog computer system as a major unit of a simulator for the Polaris missile-launching submarine program has been awarded to Electronic Associates, Inc. The contract was awarded by the Marine Division of Sperry Gyroscope Co. and covers a PACE 231-R analog computer system with low drift amplifiers and special time scale networks for "real time" simulation.

CIRCLE 103 ON READER CARD

AVCO BUYS LARGE DRUMS

Two magnetic digital storage drums, each capable of storing over 12 million bits of information, have been sold to the Electronics and Ordnance division of the Avco Corp., Cincinnati, by the Remington Rand Univac Military division. The two drums, valued at more than \$100,000, will be delivered in

'61 WJCC IN LOS ANGELES MAY BE LARGEST EVER — HILL

Early registration of exhibitors for the 9th Annual Western Joint Computer Conference scheduled for May 9-11 in Los Angeles have indicated that the 1961 conference will be the largest yet held, Richard H. Hill said recently.

Hill, chairman of the exhibits committee, expects nearly a hundred firms to display computers, readers, calculators, data processing systems, magnetic and punched tape units and other computer components and sub-assemblies.

"The computer industry," Hill said, "has moved beyond a primary emphasis on hardware research to a per-

iod of intensive marketing effort and applications development. The next few years will see severe tests of the general purpose computer's versatility." The theme for the 1961 conference, "Extending Man's Intellect," has been chosen to feature the expanding potential of the use of computers in business, industrial and scientific applications, Hill pointed out.

Exhibits will be selected from those which best project the conference theme. John Leslie Whitlock Associates, 253 Waples Mill Road, Oakton, Virginia, is serving as exhibition manager.

Here at the U.S. Naval Postgraduate School

hour after hour...day after day
for a full year

Control Data's 1604 Computer
has set a new high performance
standard for advanced large-
scale computers

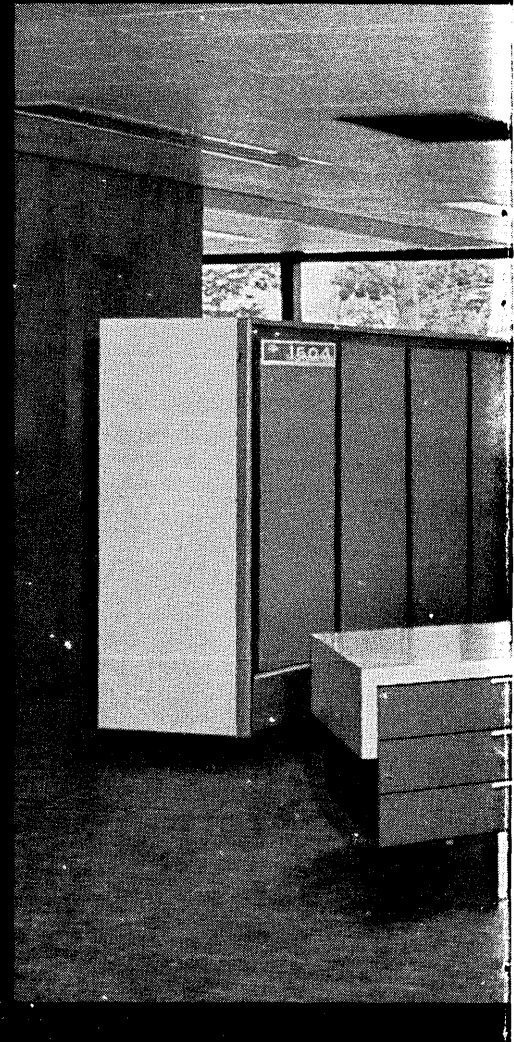

| | |
|---------------------|---|
| January 12, 1960 | The first production model 1604 arrived at the U. S. Naval Postgraduate School, Monterey, California. |
| January 17, 1960 | The large-scale 1604 Computer was put into full operation. |
| January 21, 1960 | The complete system was formally accepted by the U. S. Navy. |

Since acceptance the Control Data 1604 has been used in a variety of applications. The Navy project NANWEP (Navy Numerical Weather Prediction) makes use of the 1604 for meteorological problems, both in research and in practical applications such as weather predictions for the Pacific Missile Range and for hemisphere-wide Fleet support. In addition, students in nearly all curricula of the School receive course and laboratory work in the application and operation of the 1604 Computer and peripheral equipment.

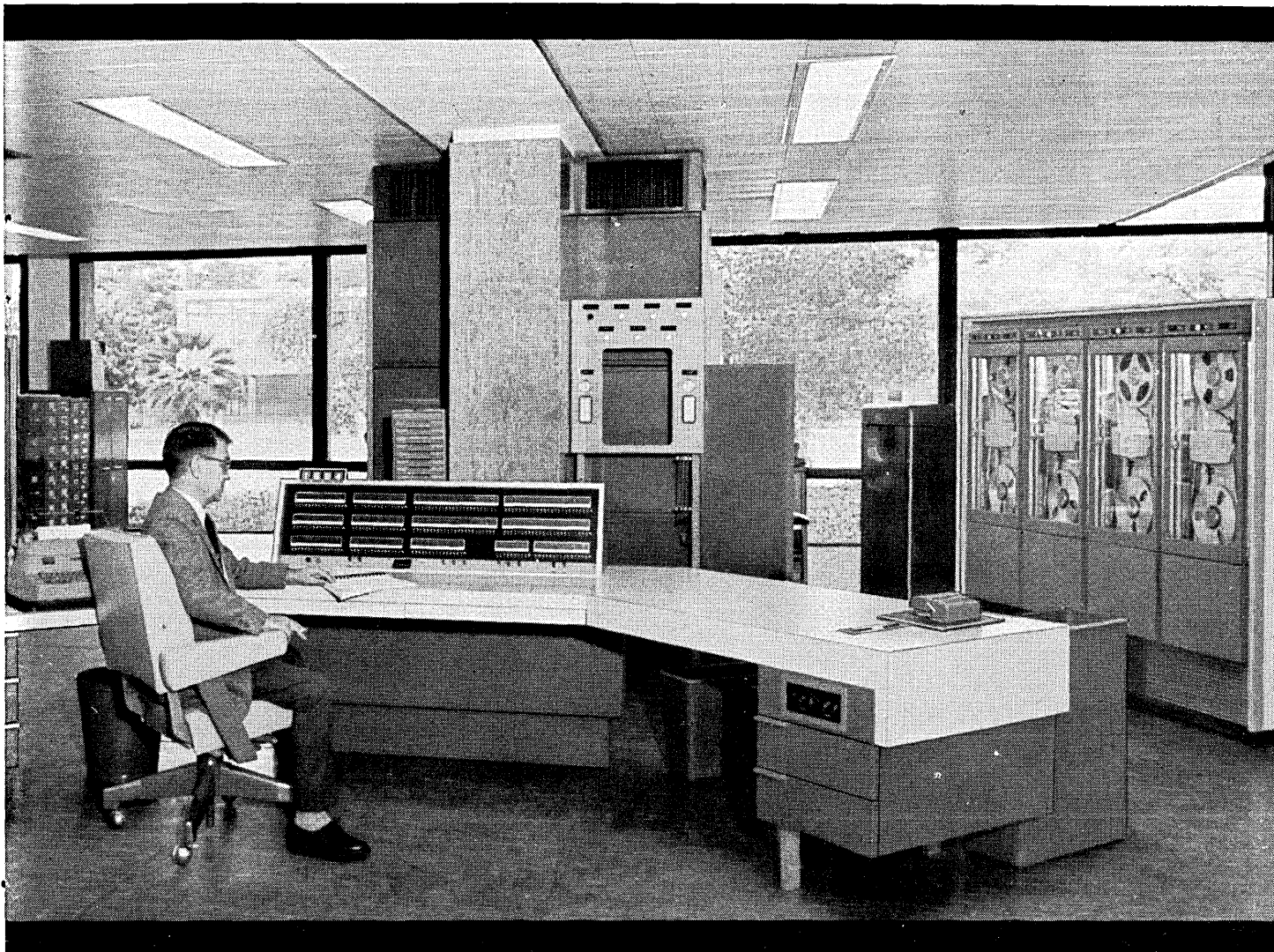

Professor Elmo J. Stewart, Director of the U. S. Naval Postgraduate School Computing Center, at the console of the 1604 which has been proving its reliability in round-the-clock performance for a full year.

HERE ARE THE FACTS

about Control Data 1604 Computers:

- The 1604 is an advanced, large-scale computer that is operating with an uptime of 98.5% (these figures represent the total history of *all* 1604 computers since acceptance).

- The 1604 costs at least \$900,000 less than any other computer in its advanced class. It is also available on lease at a 40% dollar savings.

- Provided with each 1604 are a large number of existing 1604 programs. These programs, along with programming assistance provided by Control Data, help you utilize the computing power and capacity of your 1604 quickly and efficiently. Control Data also provides the FORTRAN II Compatible Compiler which accepts any programs written in Fortran language.

- The 1604 is installed by the same project team that checks it out prior to delivery. Whether purchased or leased, each 1604 is provided with comprehensive maintenance assistance under a program to fit your particular needs.

- The 1604 is delivered within 10 months or less.

- The 1604 features solid-state, all-transistorized construction, high-speed magnetic core storage of 32,768 48-bit words, parallel-binary operating mode programmable to alpha-numeric binary-coded decimal, high capacity input-output as fast as 4.8 μ s average per 48-bit word. The 1604 will perform 100,000 computations per second.

- The 1604 has set a new high performance standard for advanced large-scale computers.

SHOULD YOU SETTLE FOR LESS?

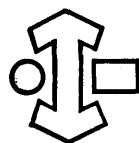

CONTROL DATA CORPORATION

501 PARK AVENUE • FEDERAL 9-0411 • MINNEAPOLIS 15, MINNESOTA

When responding, a mention of DATAMATION would be appreciated.

DOUBLE TALK

MAKES SENSE WITH EECo ALL SOLID-STATE DATA CONVERTERS FOR OFF-LINE DUTY

One data language in. Another out. Fast, accurate performance and long service life, at new, low cost. Off-line operation to conserve valuable computer time.

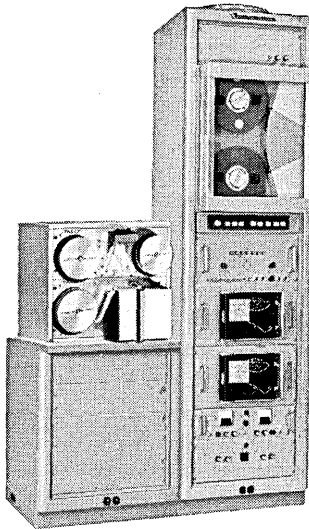

EECo-753 3-Way Tape Data Converter

for business or scientific use

• Paper-to-Magnetic Tape • Magnetic-to-Paper Tape • Paper-to-Paper Tape — 5-, 6-, 7-, or 8-level paper tape in any coding in or out. IBM 704 or IBM 705 magnetic tape in or out. Selectable block lengths up to 720 characters stored in ferrite core memory. Manual-visual check of code conversion and memory.

PRICE \$62,500 fob Santa Ana



EECo-752 Data Converter

for business or scientific use

Converts 5-level Teletype paper tape to magnetic tape for IBM 704 or IBM 705. Manual-visual check of code conversion and memory. 128-character ferrite core memory.

PRICE \$36,500

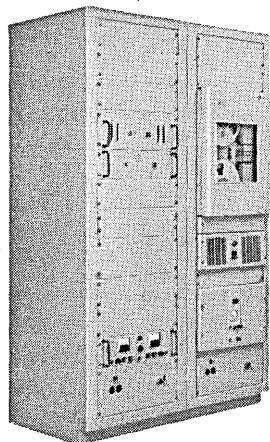

EECo-751 Format Control Buffer

for scientific use

For entry into IBM 650, IBM 704, IBM 705, IBM 709. Or can be furnished for other computers. Accepts digitized data in parallel form at random rates.

PRICE \$38,500-\$45,000

SEND FOR DATA FILE 751-3. All converters employ Engineered Electronics Co.'s all-solid-state plug-in circuits throughout.

EE Electronic Engineering Company of California
 1601 E. Chestnut Avenue • Santa Ana, California • Kimberly 7-5501 • TWX: S Ana 5263
 MISSILE & AIRCRAFT RANGE INSTRUMENTATION • DIGITAL DATA PROCESSING SYSTEMS • TIMING SYSTEMS •
 COMPUTER LANGUAGE TRANSLATORS • PAPER TAPE PROGRAMMERS

CIRCLE 6 ON READER CARD

NEWS BRIEFS . . .

April and July of 1961 for use as real-time production process recorders. They form part of an electronic data processing system developed by Avco.
 CIRCLE 104 ON READER CARD

KAISER CENTER IN OAKLAND GETS 2 REMRAND SS SYSTEMS

A commercial data processing center has been opened at the new Kaiser center in Oakland. Two Remington Rand Univac solid-state computers, one utilizing magnetic tape, form the hub of data processing center activities. The tape installation is the first of its kind on the west coast. The Center provides the 60 affiliated Kaiser companies with the facilities to process their computing requirements.

CIRCLE 117 ON READER CARD

COMPUTER SERVICES SHARES 7090 WITH SMITHSONIAN

Computer Services, Inc., of Englewood, N.J., will share a new data processing system with the Smithsonian Institution. The New Jersey firm will purchase half of the prime time on an IBM 7090 data processing system being installed at the Institution's Astrophysical Observatory in Cambridge, Mass. Computer Services, Inc. who will operate the system for the Smithsonian Institution, can also purchase as much of the available secondary time as it wishes. The 7090 will be used by the Institution to compute satellite orbits.

CIRCLE 105 ON READER CARD

ELECTRONIC DISPLAY AIDS HOSPITAL SURGERY

A new electronic system designed to assist the surgeon and anesthesiologist has been installed at Our Lady of Fatima Hospital, Providence, R.I. Designed and developed by Epsco Medical, division of Epsco, Inc., it displays information on a patient's condition during all stages of surgery. The monitor can display and record for permanent record a large variety of personal medical information.

COMPUTER LOGIC APPLIED IN DIODE PRODUCTION

Princeton Electronics Corp. of Princeton, N.J. has produced the first silicon glass diode with "computer-predicted reliability." The firm will apply computer logic to all phases of production including preparation, fabrication and testing. The entire manufacturing process will be programmed by a computer and checked throughout all

Now...IBM Control Panels

DELIVERED IMMEDIATELY

...from your local IBM office

NOW . . . IBM CONTROL PANELS

are available at all of our 192 branch offices. A phone call . . . and your panel literally comes off the shelf to meet your emergency need.

Call With Confidence . . . because IBM alone carries the complete line of control panels.

Behind The Panel . . . is IBM's liberal trade-in policy. In addition, IBM control panels may be returned for credit if obsoleted by the installation of a more advanced IBM system.

With The Panel . . . you get IBM quality and engineering know-how . . . and, most important, IBM service. This service is provided by men with an intimate knowledge of your IBM equipment and systems . . . so they can be genuinely helpful on panel problems.

So . . . next time you need a control panel, call your IBM office and get immediate delivery . . . at new lower prices . . . from the company that designed and built your data processing system.

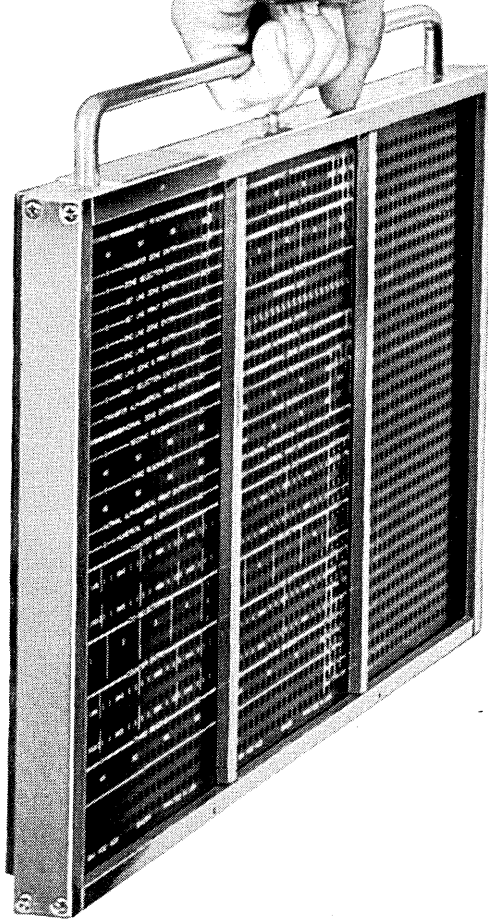

IBM[®]
DATA PROCESSING

CIRCLE 71 ON READER CARD

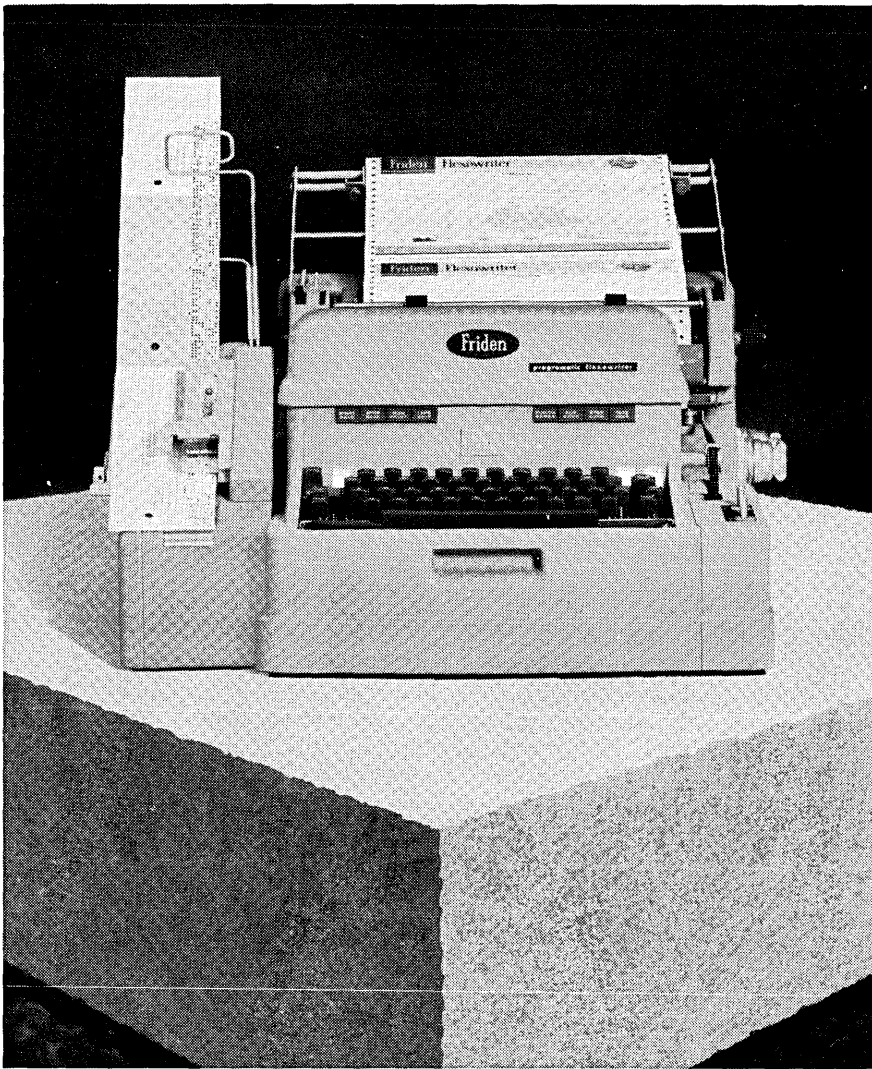

Automation Cornerstone

The Friden Flexowriter® has three basic capabilities: 1) It can type, 2) it can *record* what is typed on punched paper tape, 3) it can *read* tape back to itself, retyping automatically at 100 words per minute.

These things are remarkable enough, but the important point is this: Tapes produced on the Flexowriter can automatically control a great variety of *other* machines—those made by other manufacturers as well as by Friden. Thus the Flexowriter performs the key task in automation, *translating human language into a language that machines understand.*

Applications for the Flexowriter are immensely varied. It allows man to converse with computers. It prepares tapes that control automated machine tools. It's also bringing about a major revolution in the handling of basic business paperwork. And the surface is only scratched.

It will pay you to learn more about this machine and the jobs it could be doing for you. Your local Friden Systems Representative is the man to see. Or write: Friden, Inc., San Leandro, California. FR-71-100

THIS IS PRACTIMATION: automation so hand-in-hand with practicality there can be no other word for it.

© 1961 FRIDEN, INC.



Friden

SALES, SERVICE AND INSTRUCTION
THROUGHOUT THE U. S. AND WORLD

CIRCLE 7 ON READER CARD

NEWS BRIEFS . . .

phases of the process by a feedback system. A final analysis, based on all data relating to production and testing, will accompany each batch of diodes to its purchaser.

CIRCLE 106 ON READER CARD

NEW AUTONETICS FACILITY OPENS IN LONG BEACH

Autonetics, a division of North American Aviation, Inc., has opened a new industrial products facility in Long Beach, Calif. The new facility includes administrative, marketing, quality control and engineering sections, as well as providing for manufacture of electronic equipment for industry.

CIRCLE 107 ON READER CARD

NATIONAL ACM CONFERENCE SET FOR L.A. IN 1961

The 1961 National ACM Conference will be held September 6, 7 and 8 at the Statler Hotel in Los Angeles. On September 5th, a national council meeting will be held. For the first time, exhibits are to be included as part of the ACM activities.

The Local Arrangements Committee has been organized as follows: Chairman, Benjamin Handy; vice-chairman, John Postley; secretary, Sherman Klein; treasurer, James Tupac; advisory committee, Walter Bauer and J. Don Madden; exhibits, E. Floyd Sherman; field trips, Joseph Slap; hotels and housing, Albert Rosenthal; registration, Abraham Perez; preprints, Thomas Rowan; women's activities, Bernadette Murphy and Marjorie Hill; local program, Werner Frank and Robert Rector; publicity, Phyllis Huggins.

ACM members who would like to volunteer their services for any of the committees are invited to contact Mr. Handy at Litton Industries, Inc., 11728 W. Olympic Blvd., West Los Angeles, GRanite 8-0651, Ext. 54. Reservations for exhibit space are being taken at this time.

✓ The Dacom Corporation, a professional computing service for engineering, research and industry, has been established in Buffalo, N.Y. by William H. Mestler, president.

CIRCLE 118 ON READER CARD

✓ Dean Witter & Company has started operations of its IBM 7070 at its New York headquarters. The firm estimates that the system provides a savings of more than 250 man hours a day in the various aspects of margin and cash account work. By the end of 1961 it is

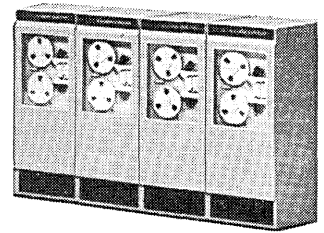
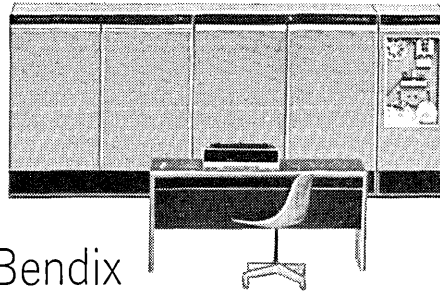
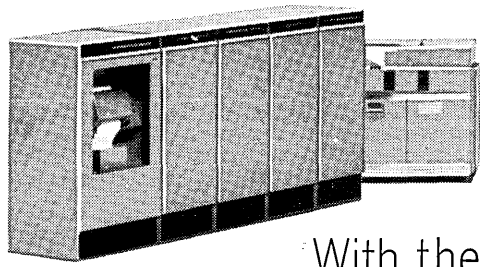

With the Bendix
G-20 Computer
You Can

MOVE UP to

TODAY'S MOST ADVANCED COMPUTING "PACKAGE"

Today's high-powered computing equipment is only as good as the programming systems that enable it to do useful work. In the development of the Bendix G-20, these all-important programming systems were planned and perfected in close coordination with the equipment designers, and received equal emphasis. The result: today's most powerful computing "package."

- The G-20's simplified programming enables your present personnel to take advantage of the powerful problem-solving abilities of the computer, regardless of their previous computer experience. Such a programming system is ALCOM—an algebraic problem-solver based on the international mathematical language of ALGOL. Compatible with the ALGO programming system for the Bendix G-15, ALCOM permits your technical staff to transmit problems to the floating point circuitry of the G-20 in universal mathematical language.
- ALCOM is complemented by a library of sorting, file maintenance and other routines for specific tasks. The refined indexing and decision-making capabilities of a powerful command vocabulary have been instrumental in making these simplified techniques possible. They are unmatched for ease of use and efficiency.
- Not overlooking the G-20 proper, we have recently increased computing speeds by 40% . . . to the rate of 83,000 additions per second (average, floating point, one-word precision). Magnetic tape speed is now 240,000 digits per second . . . and printing speed can be up to 1500 lines per minute. These new characteristics, combined with the G-20's efficient "organization chart" system design and perfected programming ease, provide an unmatched return on your computing dollar. Prove this fact to your own satisfaction.

Call the nearest Bendix Computer office, or write:

Bendix Computer Division

DEPT. E-29, LOS ANGELES 45, CALIFORNIA



CIRCLE 8 ON READER CARD

Experienced **APPLIED** **MATHEMATICIANS**

Preferably with PhD

...are invited to consider positions now available in a new applied mathematics group being formed within General Electric's Heavy Military Electronics Department. The Department's activities encompass design and manufacture of land-based and sea-borne military electronics equipment including: radar, sonar, data processors, communications systems and guidance equipment. Areas for mathematical investigation include:

ORBITS AND TRAJECTORIES

Developing new methods of integrating equations of motion and optimizing guidance system parameters in the study of earth satellite launcher trajectories and paths of lunar probes.

ANTENNAE

Re-examination of classical equations of electromagnetic theory and developing new methods of solution.

BOOLEAN ALGEBRA

Developing new methods for eliminating circuit components, investigating the use of multi-valued logics and study of new computer organizations made possible by recent advances in solid state components.

PROBABILITY

Research in extraction of signals from noise, digital smoothing and anti-jam characteristics.

GENERAL NUMERICAL ANALYSIS

Solution of a variety of problems in integration, interpolation, statistics, non-linear equations, gradient methods, eigen value problems, etc.

MANAGEMENT SCIENCES

Applications to problems in reliability, manufacturing scheduling, spare parts stocking policy, applied game theory and the transportation problem.

An IBM 7090 and programming services are available for problems requiring machine solution.

COMPUTER TECHNIQUES ANALYSTS (IBM 7090)

In support of our expanding applied mathematics programs, a newly formed computer techniques group at the Heavy Military Electronics Department is now seeking Programmers with 3 or more years of experience.

Assignments include design and implementation of automatic operator programs, data processing compilers, sort generators and other programs of general utility. Experience with IBM 709 or other buffered magnetic tape system is essential.

Applicants for both groups are invited to write in full confidence to
Mr. W. J. Eschenfelder, Dept. 56-MA

HEAVY MILITARY ELECTRONICS DEPARTMENT

GENERAL  ELECTRIC

Court Street • Syracuse, N. Y.

CIRCLE 72 ON READER CARD

NEWS BRIEFS . . .

estimated that IBM will have installed more than 40 computers at brokerage firms in Manhattan.

CIRCLE 108 ON READER CARD

✓The Digitronics Corporation has moved into its new manufacturing plant in Albertson, L.I. The new facility provides 30,000 sq. ft. of operating space, all on one floor, and is fully air conditioned.

CIRCLE 109 ON READER CARD

✓E. F. Hutton & Co. has signed a lease agreement for an RCA 501 system to be housed in its headquarters in New York. The 501, to be installed on the 12th floor of the firm's headquarters, will include a computer console, logic unit, high-speed memory retrieval unit, printers, tape machines and tape stations.

✓Laboratory For Electronics, Inc., has established a west coast facility in Monterey, Calif. Named the Monterey Laboratory, its prime responsibility will be operations analysis and computer programming for all LFE systems work. (See "People Moving Up.")

✓Cubic Corporation has announced that it will build 1,100 seven-bit static binary counters for the Naval Electronics Laboratory, San Diego. The electronic binary counters, are circuit board designed and are 5.7 inches long and 4 inches wide.

CIRCLE 110 ON READER CARD

✓A Stromberg-Carlson S-C 4020 high speed microfilm printer/plotter has been leased by the University of California, for installation at the Los Alamos Scientific Laboratory in New Mexico. The printer will be used in conjunction with research sponsored by the Atomic Energy Commission.

CIRCLE 111 ON READER CARD

✓The Air Force has ordered 10 service test models of a new digital data modem which transmits up to 5400 bits-per-second over telephone or telegraph lines from the Western Division of Collins Radio Company, Burbank. Designated as the AN/GSC-4, it is capable of full-duplex operation, or transmitting and receiving simultaneously.

CIRCLE 112 ON READER CARD

✓Adage, Inc., of Cambridge, Mass., has completed installation of an analog-digital conversion system designed for the Grumman Aircraft Corporation. This system, now a part of Grum-

HOW TO AVOID DEVELOPING A COMPULSIVE DESIRE FOR A DIGITAL COMPUTER

The computer we're warning you about is called Recomp. It looks innocent enough at first. Yet one glance can be enough to arouse your acquisitive instincts. Recomp is a handsome piece of equipment. Like fine architecture or jet plane design, it looks right because it is right; form fits function.

Something else that will appeal to your practical sense is the compact size of Recomp. It's solid state, of course; in fact, it was the first fully transistorized computer on the market. There are no voluminous rows of vacuum tubes; no ventilating problems. Yet many times Recomp can match the performance of computers that literally fill rooms.

Now, to indulge your natural desire to find out more about the finest computer in its class, just imagine you have a Recomp handy. First, plug it in; any wall socket will do, and it takes no more electricity than an ordinary electric toaster. After an appreciative look at that distinctive keyboard, try a few sample problems. You will have a full scale compiler named SALT (that's Recomp's own Symbolic Algebraic Language Translator) to help you, or you can use Recomp machine language which is the simplest of any computer on the market today. If you do not know how to operate the keyboard, never mind; in a few hours you can become an expert at programming Recomp. It doesn't even demand specialized talents; anyone with computer problems can be taught to do it.

While you're enjoying yourself at the keyboard, why not try a problem using floating point arithmetic? Of course, Recomp has it built-in; in fact Recomp is the only compact computer on the market today in which this is a standard feature. It is rather astonishing how much greater

capacity this gives you to handle a wide range of problems. Cuts down on that frustrated feeling.

If, at this stage, you can already feel the first stirrings of an irresistible urge to possess Recomp for your very own, let us counsel you: this is just a premature impulse. First you should read this unembellished list of facts:

- 1] Exclusive built-in floating point arithmetic.

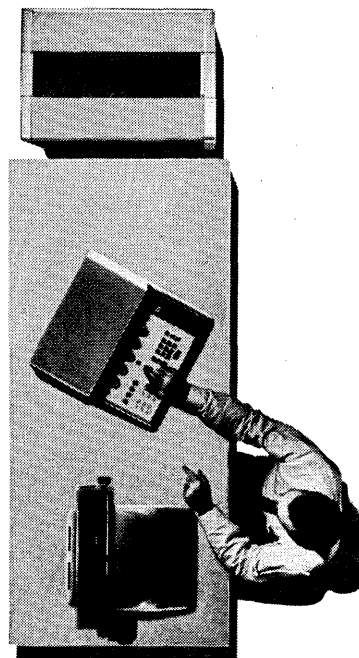

- 2] Easy to program.
- 3] Efficient programming; 49 basic instructions expandable to 72.
- 4] Fast access time due to high-speed loops.
- 5] Magnetic disk memory with large capacity—up to 8192 instructions.

- 6] Large word length of 40 binary bits.
- 7] Each word contains two instructions.
- 8] Solid-state reliability.
- 9] Built-in square root command.
- 10] Large sub-routine and program library.
- 11] Active users group.
- 12] Built-in automatic conversion from decimal to binary.
- 13] Visual display of any word in memory.
- 14] Simple correction of errors.
- 15] Easily installed anywhere.
- 16] Can use conventional teletype equipment.
- 17] Low cost per computation.
- 18] High-speed input and output.
- 19] Programming training provided.
- 20] Large program exchange.
- 21] Coast-to-coast sales & service.

No doubt you have read of other computers that claim many of these advantages, but you see, Recomp is the only one that can claim them all. This can be very disquieting when you think about it.

Now, as to how you can avoid developing a compulsive desire for a digital computer: don't see Recomp in action. For on seeing the performance of Recomp, it is quite likely you will insist on owning one. However, if you find that the insidious Recomp has made an ineradicable impression on you, it would be as well to face facts. The truth is, you need Recomp. We'll be glad to help. Our address is AUTONETICS INDUSTRIAL PRODUCTS, Dept. 012, 3400 E. 70th St., Long Beach, California. The Autonetics Division of North American Aviation, Inc.



When responding, a mention of DATAMATION would be appreciated.

1 DIGITAL DISPLAY DOES THE WORK OF 15



ACTUAL SIZE

NEW KEARFOTT DIGISTROBE* DISPLAY

Kearfott's new, highly compact Digistrobe digital display utilizes the stroboscopic principle to produce an exceptionally high-definition readout in the actual size shown here.

Through the use of a unique shutter arrangement, a single diode-encoding matrix is shared by all columns (5 in the standard model), resulting in substantial savings in electronic components and circuitry. The fast response time of the Digistrobe (56 milliseconds transition from one five-digit quantity to a totally different one) permits a single unit to sample several different inputs on command through an input selector switch. Up to 15 individual displays of existing types can thus be replaced by a single Kearfott Digistrobe!

Incorporating only two moving parts and exclusively solid-state switching circuitry, the Digistrobe has extremely long life expectancy and requires minimum maintenance and service. Operation is directly from the output register of a computer, counter or allied equipment, eliminating the cost of intervening circuitry. Two years of extensive laboratory tests assure compliance with Kearfott's rigid standards of quality. For complete data and specifications, write for Digistrobe bulletin.

*Kearfott Trademark



**KEARFOTT DIVISION
GENERAL PRECISION, INC.**

Little Falls, New Jersey

CIRCLE 10 ON READER CARD

NEWS BRIEFS . . .

man's automatic computing facility, links a 704 with a Reeves REAC analog computer.

CIRCLE 113 ON READER CARD

✓ Standard Oil Company of California has installed an IBM 7090 in its San Francisco headquarters. The 90 will be used to expand projects currently underway in research, planning and operations simulation.

CIRCLE 114 ON READER CARD

✓ Control Data Corporation has established a Research Laboratory at 5710 W. 36th St., St. Louis Park, near Minneapolis, for the purpose of conducting advanced investigations in the digital electronics equipment field. The laboratory has been equipped with high-vacuum equipment for space-environmental studies and ultra-clean room facilities for decontamination and assembly of components.

✓ More than 2,000 students and faculty members of 32 New England colleges and universities have learned how to use a digital computer since the MIT Computation Center was opened in June 1957. The Center has replaced its 704 with a 709.

✓ Effective Dec. 31, Chance Vought Corporation is the new name for the nation's third oldest aerospace company. Diversification was cited as the main reason for the change. The firm is functioning in the field of electronics, including business data processing.

✓ International Business Machines Corp. has purchased land in the Penn Center from the Pennsylvania Railroad for construction of a new office building to serve as headquarters for its activities in the Philadelphia area. The site is located at the northeast corner of the intersection of Market and 17th streets.

✓ The Radio Corporation of America has opened its Electronic Data Processing Center on the first floor of the Morton Salt Building, Chicago. The Chicago center is built around a 501.

✓ A new government contract calls for the production and delivery of two parallel Datacom systems to be used for message composition, editing, routing and similar functions. The units will be capable of handling any code or combination of codes, digital or alpha-numeric. The contract is for approximately \$170,000.

CIRCLE 115 ON READER CARD



RCA *announces...*

A New Direction in Lease Plans for Electronic Data Processing Equipment

RCA now offers a choice of *four* new lease plans that permit you to rent RCA Electronic Data Processing Equipment, and all the guidance and service that goes with it, *on a basis geared to your own particular usage requirements.* This major departure from customary leasing practice is another RCA innovation... an indication of RCA's responsiveness to the customer's needs.

DETERMINE YOUR REQUIREMENTS...CHOOSE YOUR CONTRACT!

- ➔ **IF YOU REQUIRE ONLY EIGHT HOURS A DAY OF COMPUTING TIME,** RCA offers you a contract at a rental which fits your situation precisely... and you may designate the shift you wish to operate.
- ➔ **FOR MAXIMUM ADAPTABILITY TO WORK SCHEDULES,** the Random Use Contract allows you to schedule EDP operations at periods most convenient to you. A total of 200 hours of basic use-time per month is included in the charges.
- ➔ **FOR EXTENDED USE,** where you require up to three full shifts, a basic monthly charge is made. The period covered in the contract is 24 hours a day for a 5 day week and the operating period can be enlarged to provide you with up to 16 additional hours per day for the 2 remaining days.

➔ **WHEN YOUR COMPUTER REQUIREMENTS GROW TO THE LEVEL OF THREE-SHIFT DAILY AND WEEKEND USE,** RCA's Unlimited Availability Contract may be utilized to provide all this service for a basic monthly charge. Use the equipment as much as you want!

RCA RELIABILITY... PROTECTS EQUIPMENT PERFORMANCE

Because of the high degree of reliability built into each RCA EDP System, all of the above lease agreements include primary shift maintenance of the equipment. Since RCA's Electronic Data Processing Systems have this unique built-in reliability, maintenance and service are kept to a minimum, you receive the advantage of a more attractive rate. Maintenance service beyond the primary shift is available at a flat rate per man-hour, as needed.

Take advantage of RCA's new contract arrangements to keep your paperwork at a minimum, your EDP quality at a maximum! For full details and rates, write Electronic Data Processing Division, Radio Corporation of America, Camden 2, N.J.



The Most Trusted Name
in Electronics

® RADIO CORPORATION OF AMERICA



Said Isaac Newton:

"Every particle of matter attracts every other particle with a force directly proportional to the product of their masses and inversely proportional to the square of the distances between them."

Until recently, the thrust which propelled rocket vehicles into their coast phase, prior to orbiting, was provided by booster stages. The fuel carried by the satellite stage was used only to inject itself into orbit.

Now, however, a scientist at Lockheed Missiles and Space Division has evolved a Dual Burning Propulsion System which allows higher orbits and heavier payloads. With this system, the satellite vehicle fires immediately after the last booster stage burns out, thus augmenting the begin-coast speed. Later the satellite stage is re-started to provide orbit injection.

An even more recent development by Lockheed is a triple-burning satellite stage. This will permit a precise 24-hour equatorial orbit, even though the vehicle is launched a considerable distance from the equator.

These principles have made possible the early development of the MIDAS satellite. Moreover, they substantially increase the altitude and payload of the DISCOVERER and SAMOS satellites. Lockheed, Systems Manager for these programs and for the POLARIS FBM, is pursuing even more advanced research and development projects. As a result, there are ever-widening opportunities for creative engineers and scientists in their chosen fields.

Why not investigate future possibilities at Lockheed? Write Research and Development Staff, Dept. M-15A, 962 West El Camino Real, Sunnyvale, Calif. U.S. citizenship or existing Department of Defense industrial security clearance required.

Lockheed / MISSILES AND SPACE DIVISION

Systems Manager for the Navy POLARIS FBM; the Air Force AGENA Satellite in the DISCOVERER, MIDAS and SAMOS Programs

SUNNYVALE. PALO ALTO. VAN NUYS. SANTA CRUZ. SANTA MARIA. CALIFORNIA • CAPE CANAVERAL, FLORIDA • HAWAII

When responding, a mention of DATAMATION would be appreciated.

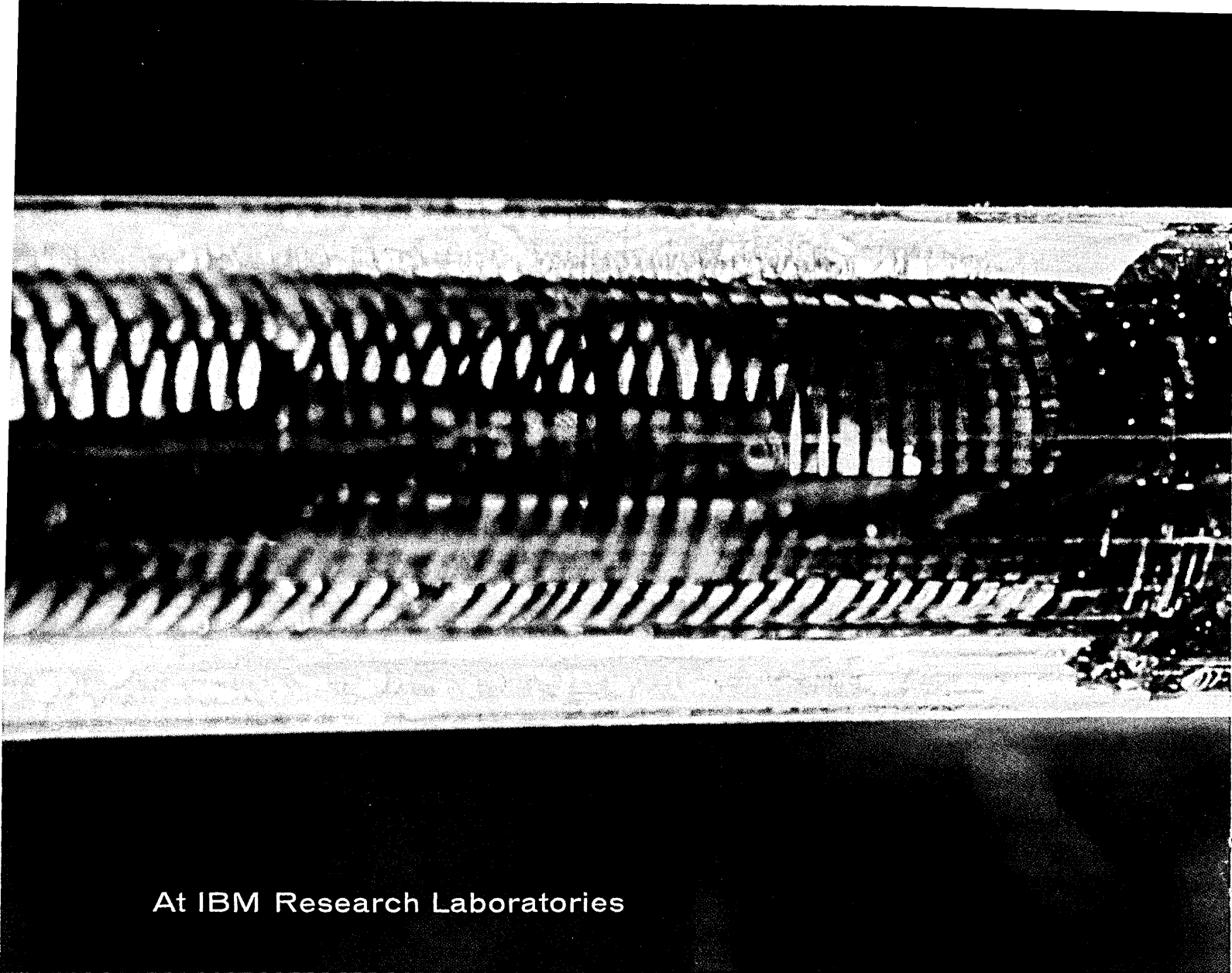

At IBM Research Laboratories

This "hothouse" grows crystals...

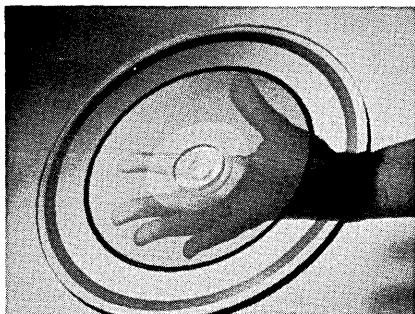

BREAKING THROUGH THE LANGUAGE BARRIER. An experimental IBM translator developed for the Air Force has been translating Russian into rough but understandable English for more than a year. Above is the machine's rotating "memory" disc. It provides the machine a vocabulary in excess of 2 million words and phrases.



DESIGNING THE BEST MACHINES FOR MAN'S USE. IBM Research seeks better ways of bridging human and computer capabilities. Above, a research psychologist studies human reliability and error making in perceiving patterns, including number patterns, one of the many fascinating subjects under constant investigation.

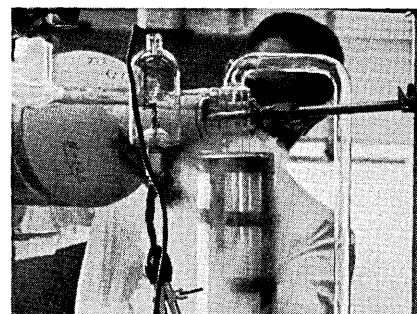

SUPER-COOLED METALS SPEED RESPONSE. In general the resistance of metals decreases as the temperature is lowered. However, there are certain metals called superconductors, the resistance of which drops abruptly at a critical low temperature characteristic of the metal. Taking advantage of this phenomenon, IBM researchers have made devices with on-off, or switching, speeds of 2 billionths of a second!

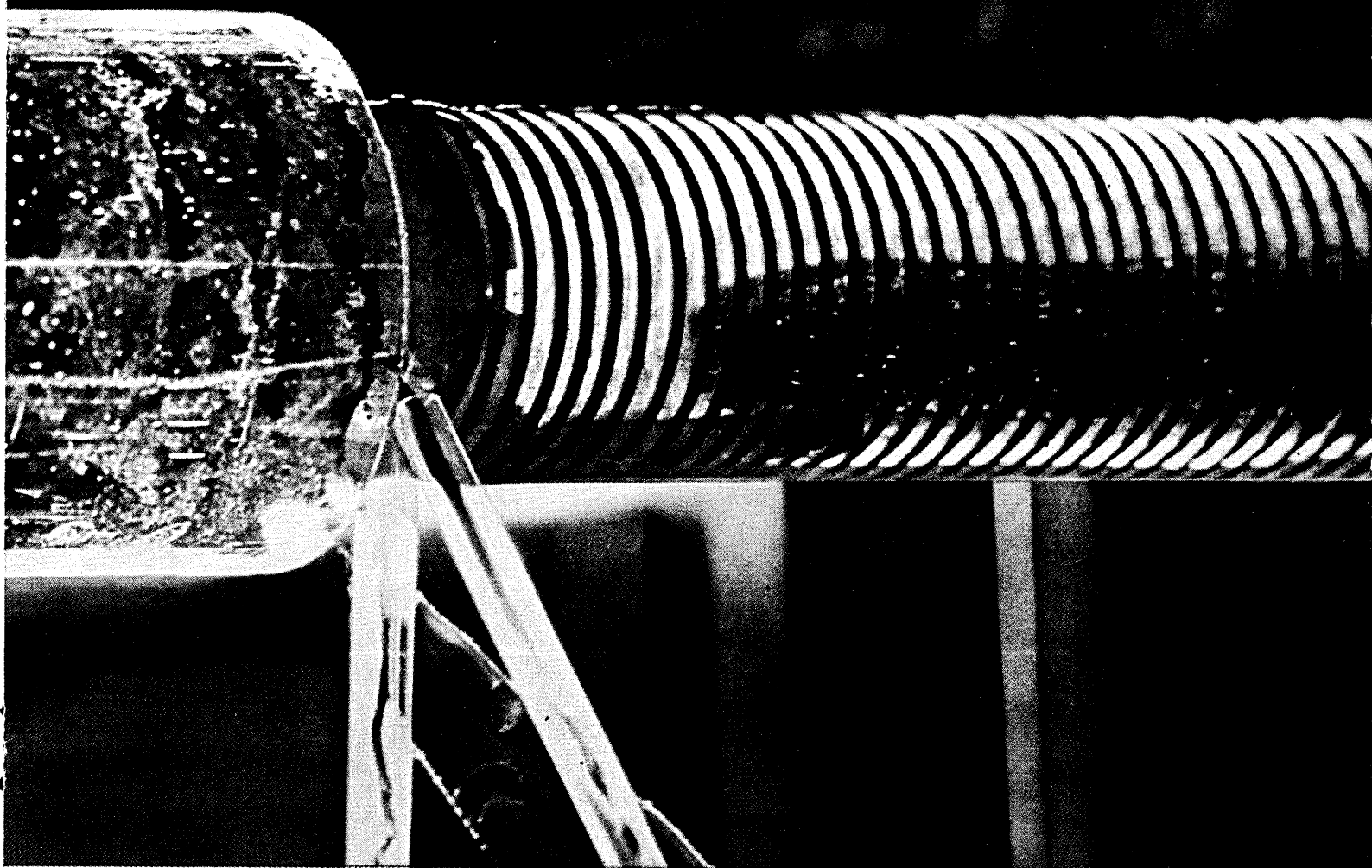

to shrink future IBM computers

Men have been *making* electronic parts for years. Today, IBM research scientists are *growing* them!

Inside this quartz tube, in an atmosphere of active gases, component parts are built atom by atom, through a process called vapor growth.

It's an intriguing process—but even more interesting is the promise that tiny, vapor-grown electronic components hold for tomorrow's computers. Data processing systems could be smaller, for one thing. And they could do a wider variety of jobs,

work faster, and lower the unit costs of processed data.

“Shaping tomorrow in a quartz tube” is only one of the pioneering and creative projects that keep our research people busy. At the left you'll see some other current projects. All are exciting possibilities for solving problems tomorrow—and all are examples of the technological leadership that helps make possible the advanced IBM systems you use *today*.

CIRCLE 13 ON READER CARD

IBM[®]
DATA PROCESSING

people moving up in **DATAMATION**

H. Malcolm Wilkinson has been appointed manager of the data acquisition and logging section of Stromberg-Carlson's Electronics Division. He will be responsible for design and construction of data acquisition systems in both military and commercial fields. He recently was in charge of instrumentation systems at Epsco, Inc., Cambridge, Mass.

Dr. Louis R. Lavine has been named manager of programming research and development for the Computer Division, Government and Industrial Group, Philco Corp., Willow Grove, Penna. He was formerly assistant manager of programming research and development, and succeeds Dr. Saul Rosen who has entered private practice as a consultant in computing and data processing.

E. Rae Wooding has been named manager of special systems engineering, Don V. Couden manager of the reliability and serviceability program, and Otto Kornei manager of magnetics in the advanced technology group by the International Business Machines Corp. General Products Division Development Laboratory, San Jose, Calif.

L. H. Orpin has been appointed general manager of Stromberg-Carlson, San Diego. He will have full responsibility for all operations at the San Diego facilities. He recently was manager of planning for defense products for the Radio Corporation of America.

Henry C. Jones, executive vice president and director of operations of The Electrada Corporation, has been elected president and a director. He succeeds Homer H. Rhoads, who has resigned to devote his full time to management consultation. Rhoads will continue as a member of the board.

Anatol W. Holt, has joined the staff of Applied Data Research, Inc., Princeton, N.J. Until recently, he was with Remington Rand UNIVAC where, together with the late W. J. Turanski, he pioneered general-purpose compiling systems with the development of generalized programming for the UNIVAC I in 1953. For

the last two years he has been under subcontract to the University of Pennsylvania, Moore School of Electrical Engineering where he developed automatic code translation, an advanced programming system concept for the U.S. Army Signal Corps. This past summer, Holt was consultant to the Rand Corporation on problems of artificial intelligence.

Phil C. Coulter has joined Benson-Lehner Corporation, Santa Monica, Calif., as manager of applications engineering. He will now be responsible for the marketing of the firm's entire line of products and services. He was formerly with IBM Corporation, where he served in sales management, promotion and advertising capacities.

Philip W. Jackson has been promoted to manager of East Coast laboratories in IBM's Advanced Systems Development Division. He was formerly executive assistant to vice president T. Vincent Learson in New York. Jackson will now manage engineering and scientific development work at the division's Yorktown, Peekskill and Ossining locations.

Rodger R. Lowe, vice president of Marc Shiwotz and Associates, Inc., has been elected to the board of directors of the electronic engineering consulting firm located in Hawthorne, Calif. Prior to joining the firm in 1958, he was senior staff consultant with the Norden Division, United Aircraft Corporation.

Richard G. Mills has been appointed vice president of Data Processing, Inc., Wellesley, Mass., consultants in digital computer applications and programming. He was most recently associated with the M.I.T. Computer Center in Cambridge, Mass.

Erwin Tomash of Telemeter Magnetics, Inc., and Dr. Richard Bellman, Rand Corp., have been elected to the board of directors of Solid State Radiations, Inc., Culver City, Calif. Tomash, president of Telemeter Magnetics, Inc., Culver City, is also director of Midwest Technical Development Corporation; Electra Scientific Corporation; and Invar Electronics Corporation. Bellman, a senior mathe-

matician at Rand Corporation, is a former member of the council of the American Mathematics Society, and the Committee on Applied Mathematics of the American Mathematics Society, and former chairman of the L. A. Chapter of the Society for Industrial and Applied Mathematics.

Dr. Gilbert W. King has been appointed associate IBM director of research for systems and engineering and Dr. Elliott W. Montroll has joined the IBM research organization as director of general science. In his new position, Dr. King will be responsible for research programs in experimental machines and experimental systems, in addition to programs in the engineering sciences. Dr. Montroll will direct all research programs in the mathematical, solid-state and general sciences.

Dr. Harry Polachek, technical director of the Applied Mathematics Laboratory at the David Taylor Model Basin has received the Distinguished Civilian Service Award. This honorary award, the highest that the Secretary of the Navy may confer on a civilian employee of the Navy, was given in recognition of Dr. Polachek's achievements in organizing and directing the Laboratory, in demonstrating the potential of high speed computers and in his contributions to scientific, technical and management fields such as nuclear reactor design, advance programming systems, and analysis of acoustic signals.

Laboratory For Electronics Inc., Boston, has recently made three appointments. Harold E. Kren has been named manager, Donald F. Criley has been named computer systems manager, and Benjamin L. Schwartz has been appointed systems manager of the firm's Monterey Laboratory. Kren was formerly administrative and sales manager for Technical Operations, Inc., Criley was a senior mathematician and program analyst, and Schwartz was a mathematician for the same organization.

John M. Norton has been promoted to technical director in the Advanced Systems Development Division of the IBM Corporation.

Programming Notes

THE CONTROL DATA FORTRAN I-II COMPATIBLE COMPILER - The Control Data FORTRAN I-II Compatible Compiler provides for the compilation and execution of programs written in FORTRAN I-II language. Object programs are written in relocatable format. This Control Data FORTRAN System has been constructed for the advanced, large-scale 1604 Computer. Run on the 1604, the Compiler Program compiles many programs at least 15 times faster than those now being run on vacuum tube computers.

In addition to compatibility with other FORTRAN systems, several improved features have been included in the Control Data FORTRAN Compiler System. These are:

The Control Data FORTRAN Compiler System includes the provision of FORTRAN-TO-RUN, called FORTRUN. This makes it possible to change FORTRAN language source statements directly to 1604 machine code. Thus, the program resides in core storage, ready to run without the use of intermediate tapes.

The Control Data FORTRAN Compiler System offers the advantage of the 1604's 48-bit word for floating point and fixed point numbers. This permits a large increase in accuracy as well as in the number of significant digits possible in the results.

The Control Data FORTRAN Compiler System provides a library designed for ease and simplicity in making deletions and additions. Thus, it is possible to modify the library with only a minimum of tape movement. During compilation, relocatable subroutines used in the program are copied from library tape into core storage.

In the Control Data FORTRAN Compiler System, the built-in functions are copied into core storage only once for any one program. Thus, repeated references to these functions (common in most programs) do not require the use of additional storage for redundant programs. This also means a tremendous savings in computing time.

The work of constructing Control Data's FORTRAN Compiler System has been directed by Seymour R. Cray, Director of Development and Dr. Robert E. Smith, Manager of Programming Research.

Control Data will be pleased to make arrangements to demonstrate its FORTRAN Compiler System at the Minneapolis Computing Center.

THE CONTROL DATA ALGOL 60 COMPILER - The ALGOL 60 Compiler will be available to all members of the CO-OP User's Organization, the members of which use Control Data's large-scale 1604 Computer.

The ALGOL 60 System is a formula translating language with considerable logical power. The recently completed Princeton Translator instruments the language as described in the paper "A Report on the Algorithmic Language ALGOL 60," in the Communications of the ACM, May, 1960.

The Translator forms the heart of the compilation system and provides considerable flexibility for local options on Input/Output programs. Thus, the compiler now in operation at Princeton University will maintain program compatibility with other installations using ALGOL, even though equipment configurations may differ considerably.

WEST COAST COMPUTER OPERATIONS - With the appointment of Dr. Richard E. Zemlin as Manager of its West Coast Programming Applications Department, Control Data continues to expand its computer services in computer applications and custom programming. Control Data's West Coast Computer Operations are located in Sunnyvale, California.

Computer Division of



CONTROL DATA CORPORATION

501 PARK AVENUE • MINNEAPOLIS 15, MINNESOTA

When responding, a mention of DATAMATION would be appreciated.

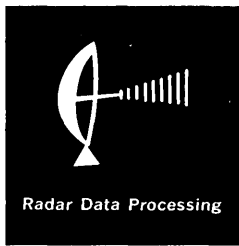

Radar Data Processing

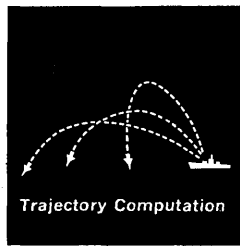

Trajectory Computation



Navigation

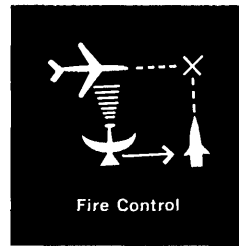

Fire Control

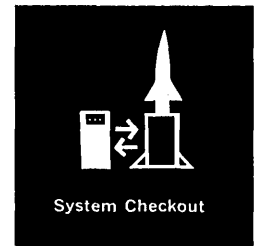

System Checkout

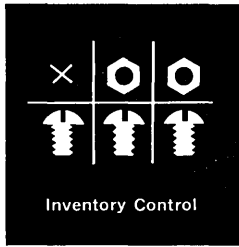

Inventory Control



Preventive Maintenance

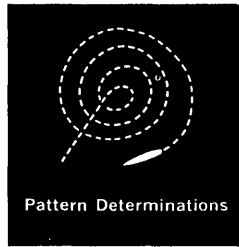

Pattern Determinations



Range Safety

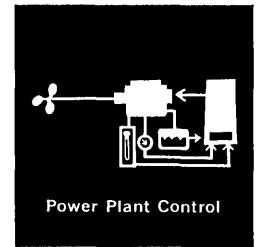

Power Plant Control



Personnel Records

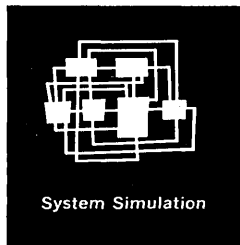

System Simulation

STORED LOGIC

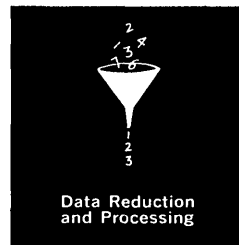

Data Reduction and Processing

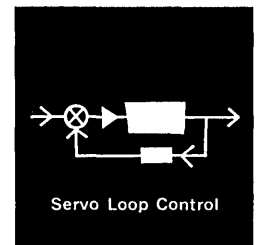

Servo Loop Control

How to get a computer to think it's a one-man gang

Most computers are pretty fussy about the kind of problems they are willing to handle. While it's true that a "business" computer can be made to do "scientific" problems, and vice versa, every experienced computer user knows it's no simple matter to get a machine to accept such a change of character gracefully. Besides the fancy reprogramming involved, the computer is likely to be inefficient and uneconomical at solving problems it wasn't designed for.

From the user's point of view, the "ideal" computer is a *multiple-purpose* machine that can be used *efficiently* in many different types of applications, and at no higher cost than a computer intended primarily for any one of these applications.

From the programmer's point of view, the "ideal" machine is one with a flexible set of instructions that can be easily manipulated to fit just about any kind of problem that comes along. Both programmer and designer are likely to agree that the most practical way to realize this "ideal" computer is by using the *stored logic* principle.

Stored logic concepts developed by Ramo-Wooldridge are being used in the AN/UYK-1, a low-price, multiple-purpose Navy computer intended for shipboard use. In the Ramo-Wooldridge approach, stored logic permits the user to select a word length, order structure and instruction repertoire especially suited to the problem at hand. These normally "wired in" characteristics are specified by data stored in the computer's memory and may be changed during the normal loading procedure without hardware modification.

The AN/UYK-1 "Stored Logic" Multiple-Purpose Computer takes its place alongside the RW-400 "Polymorphic" data processing system as an outstanding example of the kind of advanced work in computer design which has characterized Ramo-Wooldridge over the past six years. Senior programmers are urgently needed to help develop a large "software" package for commercial and military applications of R-W *stored logic* computers, to prepare programs for the polymorphic data processing system, and to work on challenging applications engineering problems. If you are qualified and interested in a career position in this field, contact Mr. Frank Nagel at

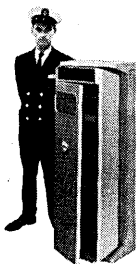

AN/UYK-1 "Stored Logic" Multiple-Purpose Computer



RAMO-WOOLDRIDGE

A DIVISION OF

THOMPSON RAMO WOOLDRIDGE INC.

8433 FALLBROOK AVENUE • CANOGA PARK, CALIFORNIA

When responding, a mention of DATAMATION would be appreciated.

ANALYZING

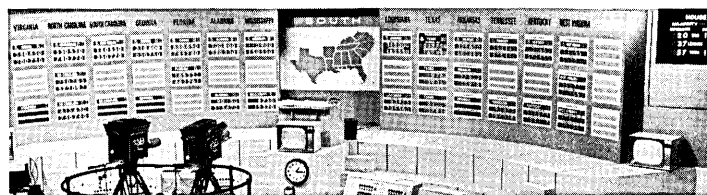

ELECTION

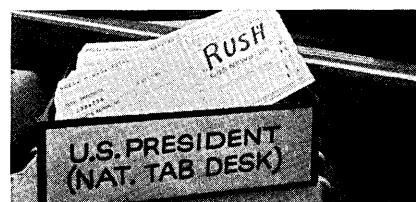

COMPUTING

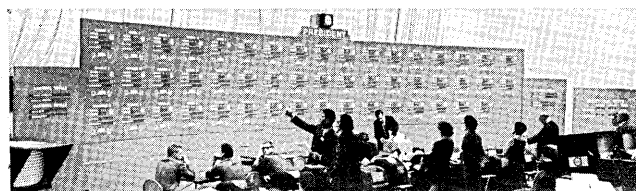

1960



QUITE EARLY in the morning on November 9, 1960, there were more bleary eyes in the United States than at any other time in the Nation's history. Millions of eyes had been fixed on millions of TV sets since early in the evening on November 8 watching ABC, CBS and NBC unfold the story of the 1960 Presidential Elections.

DATAMATION's interest in this historic night stems from the fact that the cast of supporting characters was made up of IBM, RCA and Remington Rand, or, more accurately, the 7090 and RAMAC, the 501 and Univac I.

Complete agreement as to which company and which machine performed best during this limited test would be expecting quite a lot. There was general agreement on these points: (1) IBM was first on the screen (11/8/60 8:16 p.m. EST) with a prediction of a Kennedy victory; (2) IBM and Remington Rand both predicted a Nixon victory before they swung to Kennedy; and (3) RCA at no time aired a Nixon trend (although we have it on good authority that the 501 did actually come up with a Nixon verdict which was held up pending later returns).

Another point of less general agreement — a large segment of the non-committed computing profession seemed to feel that RCA had the better plan and did a better all-around job when the returns came marching in.

On November 18, the Washington, D.C. Chapter of the Association for Computing Machinery invited Dr. Eugene E. Lindstrom of IBM, who directed computing activities for the IBM/CBS team; Stephan Wright of Applied Data Research, Princeton, a consultant to the RemRand/ABC team; and Dr. Jack Mosham, representing C-E-I-R-/RCA/NBC to discuss the Big Night's work. Their impressions, quoted directly from an ACM release, follow:

IBM's approach, Dr. Lindstrom states, was that of a straight forward statistical operation on the flow of elec-

tion returns, using past election results as a base. This was done on a state by state basis, with the state predictions being expanded into a national prediction. It was expected that the projections would eventually "home in" on the correct final result. The heavy early Nixon vote from states such as Kansas, Tennessee and Kentucky, which led the computer to make its initial victory claim, was soon outweighed by later returns which indicated a strong Kennedy swing, and the computer corrected its projections accordingly. The range of electoral vote projections after the switch to Kennedy was from 294 to 330.

Far more important than the prediction activities on election night, Dr. Lindstrom feels, were the special precinct analyses. Some 500 precincts were selected randomly from early reporting states, and subjected to intensive analysis of the effects of such facts as religion, occupation, ethnic backgrounds, etc. Dr. Lindstrom believes that when the results of these analyses are published in the near future, they will provide a rich source of material to political scientists for use in future elections.

The Remington Rand Univac model was an updated version of the successful mathematical and statistical models that were used in 1952 and 1956 elections. No special precinct data was used, and this fact adversely affected Univac's, early projections. The trend in the early reporting states, it was assumed, would hold true in the later reporting states. This assumption would be valid only if the early returns were scattered to minimize the effect of local factors. As it happened, however, the local influences in the early reporting states of Tennessee, Kansas, and Kentucky proved to be stronger than the national influences. The claim for Nixon's victory, therefore, was based on a non-representative sampling of election returns. When the heavily Democratic returns from Con-

necticut and Maryland came in, the Univac analysts threw the returns out as being deviations from the heavy Republican trends as shown in the early returns. Only when other states began reporting heavy Kennedy pluralities did Univac switch to Kennedy.

One handicap that the Univac people were laboring under, according to Wright, was their memory of the 1952 election, in which Univac's early prediction for Eisenhower was suppressed. In 1960, they were determined not to suppress any of the early projections—and learned, according to Wright, that this, too, has its drawbacks.

In revealing the details of the RCA 501's successful projections of a Kennedy victory almost from the very earliest returns, Moshman stated that RCA started with a "base line projection" which incorporated all available information—including polls—that were available before the election. This was called a "time zero projection" and was completed on Sunday, November 6, with a projected popular vote split of 50.4 for Kennedy and 49.6 for Nixon. The base projection for the electoral vote was 291 for Kennedy.

A more detailed analysis of the networks' efforts follows.

RCA NBC

by SIDNEY I. NEWRITH,
Radio Corporation of America

NBC commentator
Richard Harkness
(left) reviews a 501
projection with
one of RCA's
staff members.

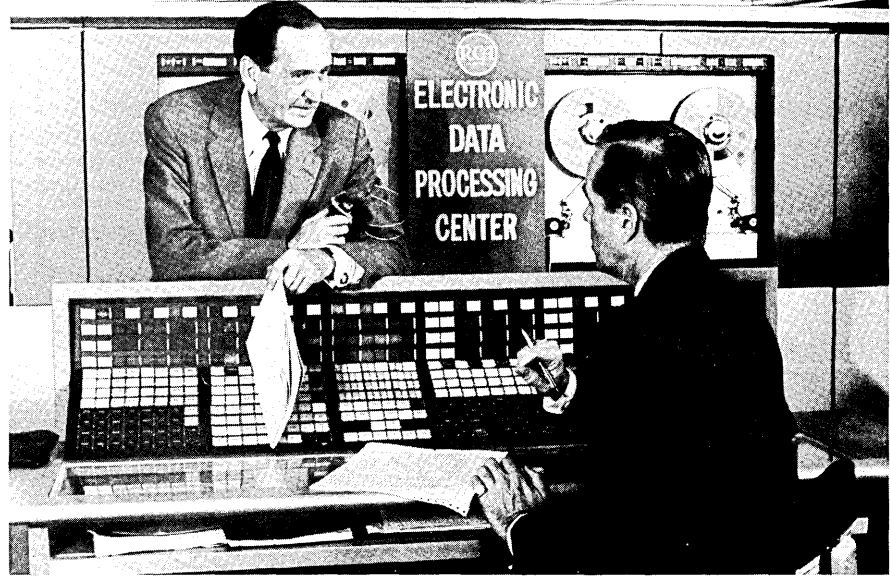

DURING the early summer of 1959, the Management of Radio Corporation of America and its National Broadcasting Company Division decided to participate in a project involving the projection of 1960 election trends on the RCA 501 Computer.

Most of "Operation Ballot" team was composed of personnel employed in the RCA family. However, technical experts from outside the company were retained to assist us in this program. For example, we retained C-E-I-R, Inc., a consulting firm. Also, Richard Scammon of Washington, D.C., a political analyst, was most helpful in pinpointing key aspects of our project. Dr. John Mauchly, founder and president of Mauchly Associates, Inc., widely recognized as one of the "Founding Fathers" of digital computers, ably assisted our technical program.

The final basis for our efforts on election night was a mathematical model—a unique set of mathematical equations with high predictive power. Members of the "Operation Ballot" team met frequently over a period of more than nine months to exactly specify the objectives of this program and to determine how it could be optimally expressed in mathematical form. To develop a sophisticated model, it was necessary to balance the mathematical—electronics know-how of certain team members and the social science know-how of others, together with the hard political "facts of life" supplied by a third group.

The Model was composed of four sections: (a) a base line constructed from, among other things, past voting patterns and demographic characteristics, (b) a sample of the Nation constructed from specifically chosen precincts which normally report early, (c) actual election returns, (d) regression on some significant socio-economic characteristics. At varying times during election night, each of these sections of the Model was utilized with automatically adjusted "weighing" of factors.

A considerable portion of our effort was concerned with the development of correct programming of the 501 to

analyze the data and to execute the projection. A pool of programmers maintained continual liaison with our mathematicians, statisticians, etc., to translate the various techniques and other requirements into computer language. These computer programs were debugged, analyzed, and dry-run to test their accuracy.

We tapped almost every important source of background data to provide us with information on what makes the American public react as it does in the privacy of the polling booth. Data analysis served the two important functions of aiding to create a realistic projection model and generating information to be stored in internal memory of the 501.

In many respects the data analysis tied in directly with our mathematical model. We constructed our model so that we would be able to project Middle West and Far West results on the basis of early Eastern reportings. In order to partially meet this requirement, it was necessary to exhaustively analyze voting behavior and patterns in past Presidential Elections as a function of a wide variety of demographic characteristics. This permitted us to match similar demographic characteristics in Middle West and Far West regions with those in the East and to deduce how the voting may have been expected to go in the Mid-West and Far West. The RCA team developed and programmed a linear regression model to initially analyze the voting pattern—demographic characteristic complex. The following incomplete list of demographic characteristics were considered in our analyses: Increase in population—1940-1950, percent non-white population, percent labor force manufacturing, median years of education of people over 25 and ratio of per capita income between election year to previous year.

One of the crucial cornerstones of "Operation Ballot" was communications. This aspect of our work was basically concerned with the gathering, processing and transmission of election returns from NBC Studio 8H at Rockefeller

Center, New York to the New York Electronics Service Center at 45 Wall Street, New York for processing by the 501. Although this project was unique in that it essentially required a one-time resolution, it had many facets which were similar to those business and industrial EDP situations, where data sources are remotely located from a computing center. In addition, because of the important nature of "Operation Ballot" and the need for extreme speed, special provisions in the form of reserve equipment and personnel were included to handle unusual or remote contingencies.

The communications network can be described best by use of the diagram in Figure I.

Actual election returns were received on election night at NBC Studio 8H at Rockefeller Center. These messages were screened and selected by an experienced staff of NBC editors. They turned over the selected messages to a group assigned the responsibility of coding and verifying the data.

Two types of RCA equipment were used at Studio 8H for this type of data processing:

1. **Tapewriter, Model 523** — a keyboard-operated device similar to a typewriter for producing a paper tape punched in the 7-bit RCA 501 code, and simultaneously printing the same information on paper stock at approximately 10 characters per second.

2. **Tapewriter-Verifier, Model 525** — a keyboard-operated device similar to the 523 but differing physically to the extent that it has a small "verify" unit attached to the left side of its body.

The information contained on the punched paper tape was electronically transmitted to the New York Electronics Service Center at 45 Wall Street by means of the RCA DaSpan System; a T-R unit, Model 5901-7 was used in the DaSpan System for transmission and reception of 7-level digital information over telephone or teletype lines. Punched paper tape acceptable to the 501 was the input-output medium. Transmission was possible in either direction but in only one direction at a time. The transmission and receiver units were located at NBC and the New York Electronics Service Center respectively. Output at the receiver end was identical punched paper tape which was immediately fed into the 501 System.

In addition, there were supplementary election returns, special early reporting precincts, coming into the New York Electronics Service Center, independent of NBC. In these instances, we also executed the screening, selecting, coding, punching, and verifying operations. This information was also fed into the 501.

It was recognized that instances could occur where information fed into the 501 would be erroneous for one reason or another. Built into our communications network was a feedback system for rapid identification and correction of any errors.

The entire system was built to accommodate 1500 messages per hour. It was estimated, however, that this many messages per hour would not be required between 7 p.m. election night and 7 a.m. the following morning; manning for this rate was merely an extra precaution. Each message contained a maximum of 30 characters. Therefore, 45,000 characters per hour could pass through our system. Furthermore, we estimated that it would take as little as 40 seconds for any specific piece of information to reach the RCA 501 from its initial receipt in the form of hard copy at NBC; in actual practice this goal was met.

Groups of people throughout RCA were carefully trained, independent of each other after hours, to perform specific functions. All our work was so organized that this system would operate within the limits of 0.6 of a second per operation. Over 100 persons were involved in "Oper-

ation Ballot," both at NBC and New York Electronics Service Center.

Essential to the success of "Operation Ballot" were procedures for expeditiously producing data message tapes and validity checking of this data. We built into our system various procedures for electronically confirming validity of information.

To insure that data had not been garbled in some fashion in its transmission from Rockefeller Center to Wall Street, we took advantage of a double parity checking system built into DaSpan.

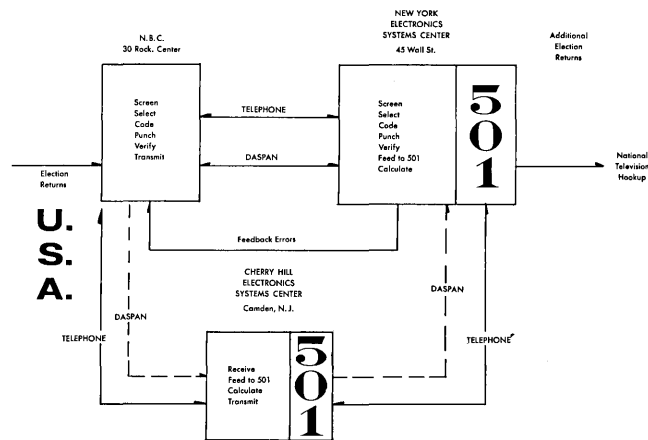

Figure I. COMMUNICATIONS

We wrote into our 501 program a series of approximately 15 tests to be executed on all information entering the system. Data that did not pass all of these tests were rejected, isolated, and subsequently corrected and re-entered. Four of these checks follow:

1. Are there a sufficient number of items in the message.
2. Is the state identified.
3. Is the number of precincts reporting greater than in the last message.
4. Is the number of Republican (or Democratic) votes greater than in the last message.

On election night, we ran projections several times per hour, commencing at 4 p.m. and running through until 8 a.m. the following morning.

RCA/NBC felt that there were two very important considerations involved in the use of computers on election night. Most importantly, they wanted only accurate reporting for the American public; indeed, only reliable projections would be publicly announced. The approach was therefore assessed on the basis of (a) an ability to project a trend and (b) an ability to assess the reliability of that trend. Based on the extensive study which preceded election night, RCA established a base line which measured early reliability. Because of the heavy returns and the unusual character of this election, early projections were not made public since they did not satisfy the reliability criteria. The first indication of a reliable trend was given by the RCA 501 and announced on television at 8:22 p.m. The error in projected percent of popular vote at this time appears to be less than 9/10ths of 1 per cent. A refinement of this first projection with an apparent error of only 4/10ths of 1 per cent was made at 8:32 p.m. The first Electoral vote announcement was made at 9:02 p.m. and showed a definite Kennedy trend.

Continuing projections were made several times an hour for use of NBC commentators. The requirement for reporting a state as being either Nixon or Kennedy was that the state have at least an 80 percent probability of going to a particular candidate. If the probability was less than 80 percent, the state was considered doubtful.

IBM CBS

by DR. G. TRUMAN HUNTER,
International Business
Machines Corp.

CBS commentator
Howard K. Smith
discusses trend
analysis with IBM's
Dr. E. E. Lindstrom
(left).



AT 8 p.m. EST on November 8, while millions of Americans settled down in their living rooms to start a night-long watch of election returns and millions more still were to cast their ballots, an IBM 7090 data processing system printed out a forecast in New York. With three percent of the nation's precincts reporting in what was to become one of the closest elections in American history, the computer placed the odds at 11 to 10 in favor of Sen. John F. Kennedy. It indicated there would be a 50-50 split of the popular vote. (Editor's Note — to DATAMATION's knowledge, the first actual radio and television announcement was made as noted below. All networks and manufacturers involved conceded that this was the first correct computer forecast aired on election night.)

At 8:16 p.m. EST, with only four percent of the precincts reporting, CBS newsmen broadcast another IBM 7090 output: The odds were 11 to 5 in favor of a Kennedy victory, with a forecast that he would receive 297 electoral votes.

A concentrated programming effort made possible this unique advanced insight into the election for CBS viewers. Five mathematicians and four systems specialists, all employees of IBM, devoted 76 man-months to the project.

The programs they developed were particularly appropriate this year because of the unusual nature of the election, which directed great public attention to the demographic aspects of the race.

The CBS-IBM election coverage involved three phases:

1. The rapid tabulation of votes as they came in from field reporters, the wire services and party headquarters.
2. Analysis of voting patterns and trends throughout the night.
3. Forecast of the outcome based on a small percentage of returns.

The machines involved in this coverage were a RAMAC 305 and the 7090. The 305 system — located at a CBS studio — was selected for tabulation of votes because of its on-line random access abilities. As returns came in, the data was punched into cards and fed into the computer.

The 305, reacting to a 250-step program, used a direct address system — based on state and candidate name — to place data in the proper disk storage location. Also stored in the machine were the candidates' names, the number of precincts and the maximum number of votes possible in each state based on registration.

With this information available, the 305 was able to complete in rapid sequence a number of important test conditions: first, it checked each report to see that the

number of precincts reporting and the total votes did not exceed the maximum possible for that state. Any reports failing these tests were rejected by the system and returned to CBS editors for investigation.

Next, to further ensure the validity of the results, the computer compared the input data with previously recorded figures for the same state and race. Only higher figures were used by the machine to update state and national results and compute the resultant change in percentages. These figures were then printed out simultaneously on one of four on-line remote output units representing geographical regions, an on-line 407 and the national recap lightboard visible to the television audience.

The average time from card punching to display was about a minute.

"Tele-processing" techniques sped this data to the 7090. As soon as the cards passed through the 305, they were placed in Transceivers and sent about two-and-a-half miles over telephone lines directly to an IBM Datacenter, where the 7090 was located.

Two programs were developed for the 7090's computations on election night: a Tally and Special Precinct Analysis (TSPA) program which was stored in the machine's memory the greater part of the evening; and Forecaster (President) and Forecaster (House and Senate) programs which were called in as requested from magnetic tape.

TSPA served as a multifunction program for the 7090. Cards transceived from the 305 were fed in directly via an on-line card reader. The Tally phase of the TSPA program then took over — providing important computational backup by reproducing the RAMAC's calculations. The Tally program also — on request — produced summary reports for all races across the nation.

The Special Precinct Analysis, however, provided some of the most interesting highlights of the evening. Some 502 precincts in 17 states had been selected at random before the election and researched carefully by political scientists. The results of this study were written into the TSPA program. This data included the previous voting habits of each precinct, going back as far as 1928, and the outstanding demographic features of the area (Negro, White, Anglo-Saxon, German, Irish, Catholic, Protestant, rural, urban, blue collar, white collar and so forth).

In short, the program was supplied with the past voting figures and demographic features of each precinct in the sample. This data then could be interrogated in two phases:

The first, or RANK phase, permitted ranking of the weathervane precincts by some voting extreme, such as

high Democratic percentage in 1956. Prepunched RANK cards were kept at the console and on request were processed through the 7090 to provide CBS commentators with current and past trend data. The RANK phase also examined the top one-eighth of the precincts and listed as output any demographic features present in more than half of them. Thus, voting trends simultaneously were noted and analyzed.

The second, or SELECT phase, involved precincts with certain demographic features, such as Irish, White, Protestant, New England and so forth. Prepunched SELECT cards were processed by the 7090 on demand. Comparison between any two election years for which data was available was provided. The composite voting performance of these precincts — with respect to the presidential and house vote — then was computed by the 7090 and given as output.

Thus, through the use of the RANK phase the source of voting extremes was determined; and through the SELECT phase voting preference of persons with specific backgrounds and surroundings was examined. Throughout election night the Special Precinct Analysis program offered a more rigorous and revealing answer to many vital questions than could be had through speculation and similar techniques.

Forecasting requires the inference — from facts or proven laws of nature — of the result of a future event. If by definition the result is unknown, then a chance of failure always is present. In the specific case of an election, there are these hazards:

1. A change in the nature of the electorate from previous elections could influence results.

2. There is a likelihood of change in the reporting order. This year, for example, at the outset of the evening Kansas reported votes one hour earlier than in 1956. This stacked the computer, as it were, for a Republican majority because so few votes were involved.

This trend, incidentally, was broadcast at 7:26 p.m. with about one percent of the votes reporting, accompanied by the qualification that there was “inadequate information for prediction.”

Within a short time, however, additional returns changed these figures and the computer was able to home-in on the trend to Kennedy.

3. The possibility of incorrect data is always present. In the CBS-IBM coverage this was minimized as much as possible through built-in program checking steps.

In essence, a statistical model of the 1956 election was set up within the 7090 and the 1960 returns were compared with it. Thus, with only 3% of the precincts reporting, a valid decision was reached — one that held up throughout the night and next morning.

While it was anticipated that the TSPA program would be used throughout the night, this was not supposed to be the case for the Forecaster programs. The unusual closeness of the election, however, brought it in almost as frequently as the analysis program. This proved to be a boon in demonstrating the ability of such a program to perform the job for which it was designed.

In fact, the continued pinpointing of the election outcome by the Forecaster program during its prolonged use demonstrated graphically how a computer can home-in on a valid answer on the basis of small samplings.

In preparation of such a Forecaster program, IBM had two possible approaches: a sociological point of view which would call for thorough analysis of people's voting habits; or a statistical point of view which was essentially an extrapolation model. The latter approach was taken.

The use of computers for tabulation, forecasting and analysis had demonstrated its ability to become a permanent election eve fixture. Here — as in hundreds of other cases — electronic equipment, carefully programmed, can provide the speed, accuracy and efficiency to bring facts to the fore while they are still valuable.

REM RAND ABC

by DR. MAX A. WOODBURY,
Remington Rand Univac Consultant

Dause L. Bibby (left),
president of Remington
Rand, explains Univac's
operation to
ABC President
Oliver Treyz.

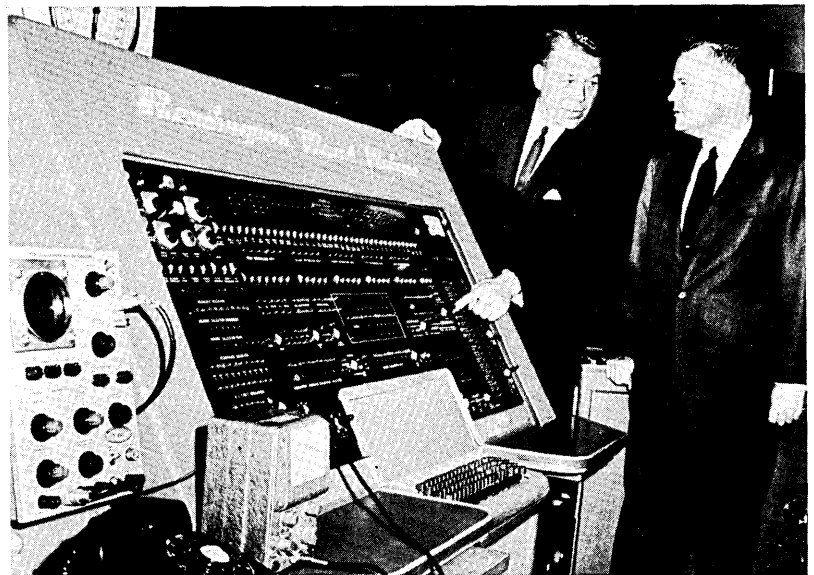

PRIMED with \$500,000 in election data programming, Univac I was readied for the November elections since last Spring.

A team of 100 researchers, programmers and computer experts were involved in the election night prediction project. From previous elections, an hour by hour vote trend was stored in the computer memory unit together with statistical analyses of past results in key areas, unique trends and switches in voting strength as well as weather conditions (and how they effected voting).

The computer was located at the Remington Rand Uni-

vac Service Center, 315 Park Avenue South, New York, where an ABC remote unit was stationed to pick up its calculations.

In its earliest prediction at 6:54 EST, Univac I's calculations were known to be in error and were “released with a hedge.” The prediction of 275 electoral votes for Nixon, 103 for Kennedy and 159 still in doubt was clearly an erroneous prediction after the fact (10 to 1 for Nixon).

Univac's estimate on the air at 8:48 p.m. favored Kennedy with odds of 7 to 5. The sample of states was then still non-representative, however, in the presence of the

"Catholic swing to Kennedy." Univac had its first representative data by about 10 p.m. and made a prediction at 10:24 indicating that the election was Kennedy's (by odds of more than 100 to 1).

The basic uncertainties in the presidential race remaining at 1 a.m. on November 9, 1960 concerned the disposition of the electoral votes of Alaska* (0.82), California (0.40), Delaware (0.57), Florida (0.45), Hawaii (0.21), Minnesota (0.86), Montana (0.17), Nevada* (0.44), New Mexico* (0.23), Oregon (0.15), and Washington (0.29). The parenthetical figures are the estimated probability of a Democratic win in the respective states. The states marked with asterisks did not go as indicated. This is not too surprising as on the average we would expect to be wrong on $3.13 + 0.08 = 3.21$ of the states and missing on 3 is consistent with the expectation. The basic uncertainty is relatively larger for electoral votes, we would expect to have 28.17 of these in the wrong columns on the average.

Of course there is the possibility of compensating errors so that the basic uncertainty in the total EV would be less than the above. In fact, Univac's final call gave 332 EV to the Democrats (including 8 uncommitted EV in Mississippi and 6 in Alabama).

There is a distinct correlation between the electoral vote and the popular vote percentage indicated. As near as could be determined empirically, the equivalence was 4 electoral votes for each 0.1% of the popular votes for both Univac and the RCA-501 procedures. If this factor is taken into account as indicating too high an electoral vote when the Democratic proportion of the popular vote is high, it is possible to "adjust" the EV for both computers to the level arrived at in order to see how large an effect the overestimates might give. The final estimate seems to be about 50.2% of the major party vote for the Democrats.

In the Congressional races, where the religious factor was not directly involved, predictions were accurate from the first which was aired at 10:24 p.m. The computer showed the Democrats controlling the U.S. Senate with 65 seats against 33 for the Republicans with 2 seats undecided. Actual results: 64 for the Democrats and 36 for Republicans.

The same accuracy was shown in predictions for the House of Representatives with 257 Democrats, 162 Republicans and 18 undecided.



DIGITAL DISPLAYS

A NATIONWIDE television audience viewed the returns of the recent presidential election on an in-line digital display unit manufactured and developed by Industrial Electronics Engineers, Inc. of North Hollywood.

All three major broadcasting networks used this manufacturer's equipment.

The unit is a complete rear-projection system and viewing screen. Its projection lens has 12 individual lens curves, one for each of the digits or characters that the particular unit is designed to display. Behind each lens curve is a projection lamp so placed that each of the lens curves projects its image at the exact center of the viewing screen. Since the viewing screen constitutes the entire front surface of the unit, a number of units clamped side by side display multi-digit numbers in perfect alignment.

ABC used the series 10000 model, with figures 1 in. high. The type face used was plain, modern Futura medium. CBS and NBC both screened returns on the series 80000 model, with figures 3 in. high.

The ABC and NBC display units were operated by manual switching in remote control rooms off screen. The CBS units were attached to a RAMAC 305 which operated them automatically.

CIRCLE 136 ON READER CARD

AN EDITORIAL...

THE NETWORKS missed a bet!

The bet would have resulted in a sure thing . . . more interesting, thorough, enjoyable coverage of the 1960 elections. This attractive prize lay well within the grasp of ABC, CBS and NBC. It lay just beyond the computers and the people who operated them (that hazy background behind most of the commentators, remember?).

To the average viewer, the fact that correct predictions were made sooner than ever before in history must have seemed like very good luck, indeed. And, as far as anyone could tell, the constantly changing popular vote count pictured on the various displays was being generated by a man (just behind the partition) turning a crank at rather irregular speeds.

One manufacturer noted that the computer firms involved "devoted their best resources and sturdiest efforts to the projects." The contest between computers was not necessarily one of hardware efficiency. Rather it was a demonstration of system analysis and development, of programming effort. Complicated machines, then, would have been the lesser part of the story. The people who made them operate and who could have explained how they operate

would have been brought into focus, literally.

Granted, computers were not the stars of the show. Coverage of the elections should not have been reduced to a computer sales arena. But, more often than not, commentators seemed to be killing time by casting about for something to say or somewhere to send the camera while waiting for significant changes in predictions and returns. It was at these times, we contend, that computer programmers and analysts could have been interviewed. Someone (qualified) could have explained how information got into the machines, how it was processed, how it came out.

IBM, Remington Rand and RCA would have been happy to see the more practical aspects of the venture brought to the fore. In discussing election forecasting, an RCA release notes:

"In any parallel situation in business and government operations, where long-range decisions depend upon accurate analysis and interpretation of social and economic statistics . . . data processing can help yield meaningful results."

More important in our opinion, however, is the fact that a valid, meaningful opportunity to take computers out of the "mad scientist" category was missed.

The "giant brain" which "thinks like a man" lives on. The tremendous effort expended by the three networks suffered accordingly.

—S. A. Lanzarotta

NEW!

From MAC Panel Co.

Available immediately . . . MAC Panel's new plugboard programming systems complete with lightweight removable plugboard and complete line of plugwires. There are six systems ranging in size from 160 contacts to 5120. All economically priced.

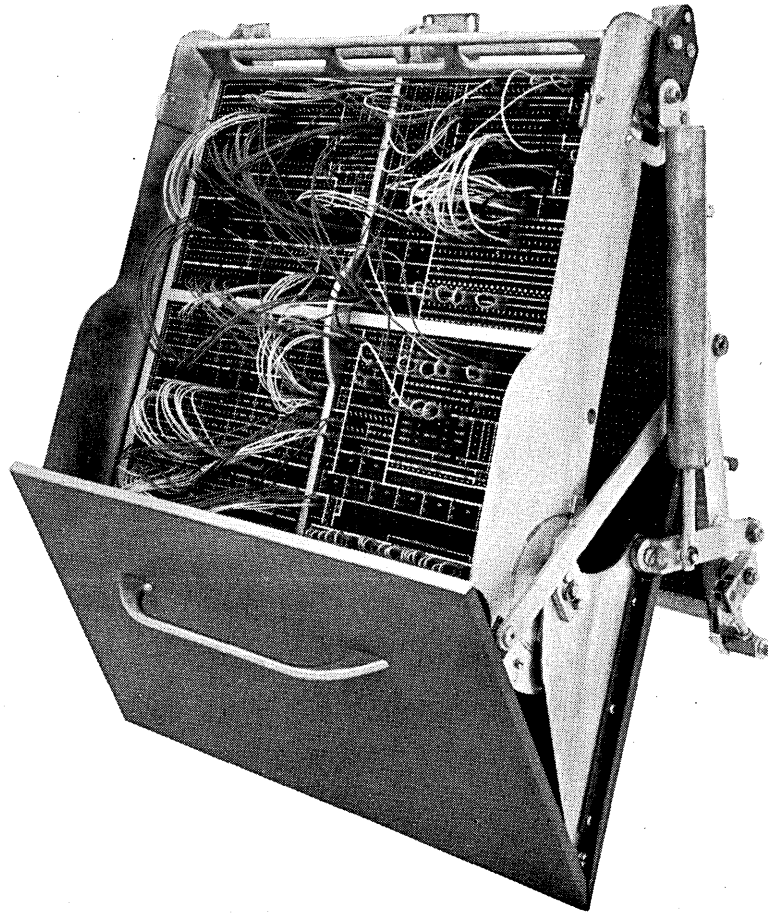

Plugboard Programming Systems

■ Rugged, reliable, time proven receiver mechanism ■ Easy plugboard insertion ■ Integral door for flush cabinet mounting ■ Plugboards silk-screened to order and printing then baked to a chip-proof hardness ■ Single, dual and dual shielded plugwires in numerous lengths with manual or fixed tips ■ Plugwire tips and contacts, gold or nickel plated

For More Information
Use The Handy Coupon

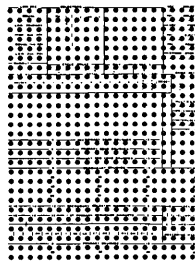

MAC PANEL

J. V. Simone, OEM Division, MAC Panel Co.,
124 College St., High Point, North Carolina

I am interested in your Programming Systems. Please send your catalog.

NAME _____ TITLE _____

COMPANY _____

STREET _____

CITY _____ STATE _____

thin films are here!

REMRAND ANNOUNCES 'THIRD GENERATION' 1107

by DR. H. R. J. GROSCH,
Consultant, New York City

IN A MEETING for security analysts and reporters with special interest in the computer field, Remington Rand Univac demonstrated a thin-film magnetic memory and announced the UNIVAC 1107 scientific computing system which will incorporate this novel ultra-high-speed component. The St. Paul sessions, held December 6, included press releases marked for December 15; Wall Street interest was so strong, however, that officials of the New York Stock Exchange urged Dause Bibby, Rem Rand president, to move up the official announcement to December 9. Public relations people at Univac thereupon called the thirty or so attendees and gave an OK for immediate publicity.

The cause of the excitement is embodied in a 20 by 20 array of permalloy spots 50 mils (0.050 inches) in diameter, spaced 100 mils center-to-center, and only 1000 Angstrom units (4 microinches) thick, evaporated onto a thin glass substrate. Production arrays, 8 by 16, are even finer, with spots only 20 mils across. Dr. Sidney M. Rubens, director of physical research at St. Paul, showed his experimental facilities, and also a small production setup capable of turning out several 1107 memories per shift per week.

Rubens explained that a preferential magnetic direction is established in the films during deposition. A current applied in an adjacent conductor parallel to this preferential direction causes a slow polarity reversal ("slow" equals several microseconds!) but if a very small current is simultaneously applied in another conductor at right angles to the principal axis, response steps up to only a nanosecond

Remington Rand Univac's "third generation" computer, the 1107, contains a basic core memory but employs the first thin magnetic film memory, the "control memory," announced in the industry to date. Model pictured.

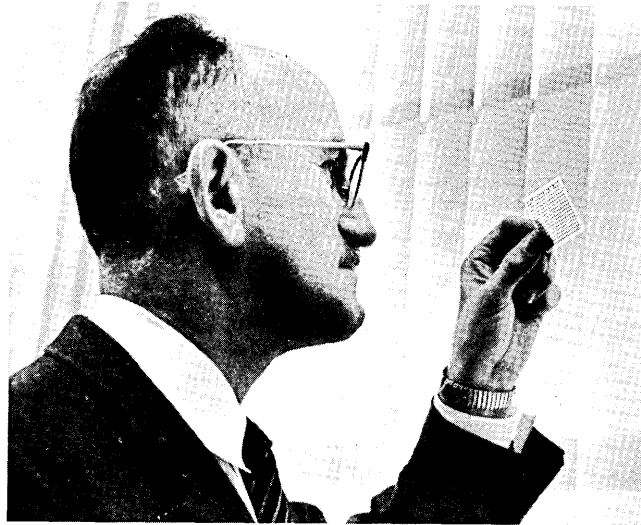
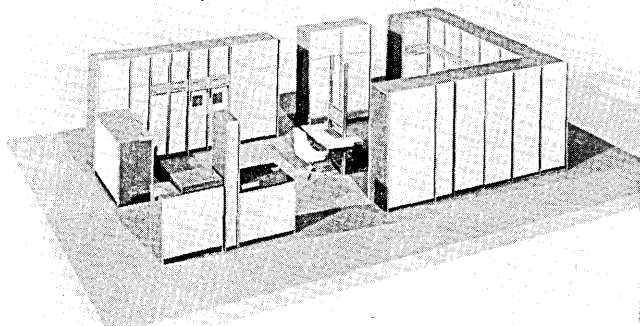

Remington Rand's director of physical research at St. Paul, Minn., Dr. S. M. Rubens, examines a substrate of thin film similar to that found in the new Univac 1107.

(one billionth of a second, or one millimicrosecond) or so. Including all drivers and selection switching, and with ample safety factors, total memory access time is 0.6 microseconds, the fastest erasable memory yet announced. IBM has apparently withdrawn the 0.5 microsecond core memory planned for the Los Alamos STRETCH, and the 0.2 microsecond "store" for the Ferranti ATLAS is permanent — no read-in, no erasure, just read-out. Remington Rand has experimented with this kind of memory (they use the term "catalog") in a different thin-film configuration, and claim speeds of 10-100 nanoseconds, and they have already considered the films for shift registers.

For the 1107, a super-sandwich of 36 plates separated by 36 mylar sheets carrying the photo-etched copper conductors, N-S on one side and E-W on the other, has been assembled. This is used at the center of activity: a "control memory." The main store continues to be ferrite cores, up to eight units of 8192 words each being available. The results of all arithmetic operations are deposited in film memory, which is also involved in many logical operations, and these intermediate results are addressable for subsequent operations. Speed-up operations of this sort are squeezed into the normal single-address order format in such ways that the programmer can use the machine as two-, three-, or even four-address where the limitations of 128 words of film memory are not serious. By such logical design departures, rather spectacular speeds can be attained without resorting to unusual (and expensive) core and transistor packages.

More complete information on operation sets, speeds, indexing power and so on is expected next week at the EJCC. The St. Paul visitors were told, however, that floating point orders will take 12-15 microseconds, and logical operations about 4. There is a form of 6-bit byte manipulation, 15 index registers, double-accuracy mantissas resulting from FP operations, 16 36-bit input-output channels with preassigned "hardware" priorities, and the usual list of peripheral gear.

As for software, ALGOL, a FORTRAN translator, COBOL (!), and a voluminous array of generators and assemblers will be available with the first production machine, Remington Rand says.

Rentals range from \$40,000 to \$60,000 per month, and delivery is 18 to 24 months.

Other St. Paul developments of almost equal interest were disclosed at the December 6 charivari, notably the UNIVAC 490 real-time system. Reports are planned in the February DATAMATION.

CIRCLE 137 ON READER CARD

RUSSIANS INTENSIFY TRAINING IN COMPUTER TECHNOLOGY

THERE ARE an increasing number of signs that high Soviet officials have intensified their interest in automation and computer technology and are beating the computer drums with renewed vigor.

A look at the past, present and future of the Soviet computer training program is presented in a five-page bulletin prepared by the U.S. Dept. of Commerce. Topics covered are: Intensification of Effort, Computer Training, and Cybernetics and Machine Translation Training.

Many new courses are being offered on the undergraduate level in Russia and several examples are listed in the bulletin, including other steps taken to accelerate information processing training since 1956.

Khrushchev and other high Soviet officials have stressed that a major task of Soviet science during the current



seven-year plan (1959-1965) is the solving of problems connected with automation and computer technology.

The pamphlet states that each year 100 Moscow State University (MGU) graduates receive their diplomas in computer technology. Since 1953 the Chair of Computer Mathematics at MGU has accepted a half dozen post graduate students in computer mathematics every year. Information is presented concerning various computer training courses offered at the major universities and the Academies of Science in the U.S.S.R.

A limited supply of computers has restricted the quality of computer training in Russia, but as more machines are produced this shortcoming will be eliminated. It is estimated that various republic academies of sciences will engage in work in the computer field in the next 7 years, according to A. N. Nesmeyanov, president of the Academy of Sciences, U.S.S.R.

The relatively recent interest in cybernetics and machine translation training in Russia is briefly covered from the year 1948 when a change in official policy

toward mathematical logic took place. By 1957, mathematical logic was being taught openly in graduate seminars in the Mechanics-Mathematics Faculty of MGU. It is stated that in addition to mathematicians, the Soviets have begun to divert some physicists, physiologists and biologists to the task of working on "thinking machine" problems.

Also included in this review is a table showing examples of the types of Soviet institutions and levels of training offered in automation, computer training, cybernetics and machine translation. For a copy of "The Soviet Training Program for Automation and Computer Specialists," send 50¢ to U.S. Department of Commerce, Office of Technical Services, Washington 25, D.C.

'MIND' ANNOUNCED BY AERONUTRONIC

SMALL, DOUGHNUT-SHAPED electronic "neurons" which reportedly artificially duplicate portions of the human nervous system and carry out learning processes, have been developed by Aeronutronic, a Division of Ford Motor Company, Newport Beach, Calif.

Announcement of the new device, called MIND (Magnetic integrator Neuron Duplicator), was made recently by Dr. Lloyd P. Smith, general operations manager of Research Operations at Aeronutronic.

The electronic "neuron" is about a fourth the size of a penny and is composed of a magnetic core with an inner hole through which wires are strung. The ceramic (magnetic) core is capped with a metal washer and again wound with wires.

The artificial neuron was developed by Aeronutronic as part of a research program sponsored partially by the Department of Defense to build machines that can duplicate some of the activity and reliability of the human nervous system.

The MIND device was developed by Aeronutronic for the Perceptron Program. The Perceptron is a model of portions of the nervous system devised at Cornell Aeronautical Laboratory, Buffalo, New York.

Development work on MIND was accomplished under the direction of Joseph K. Hawkins, manager of Self Organizing Machine Research at Aeronutronic.

Hawkins said the device is modeled after the synaptic junction found in human and animal nervous tissue. This junction, he explained, is a relay point for passing signals from one nerve cell to another. One concept explored by physiologists is that some of the synapses in the brain are the site of memory.

Hawkins explained that the synaptic junction is like a door which enables someone or something to pass from one room to another, then closes to prevent others from entering. Similarly, the synaptic junction selectively passes certain signals from one nerve cell to another.

Aeronutronic's neuron-like MIND device, like a living cell, can remember experiences and learn new facts under control of a human or mechanical teacher.

The artificial "neuron" stores or "remembers" the effects of past events by increasing or decreasing the amount of flux stored in a magnetic circuit.

CIRCLE 138 ON READER CARD

NSA/AF/NAVY

by HERMAN LEVY, Aeronautical Structures Lab,
Naval Air Material Center
Philadelphia

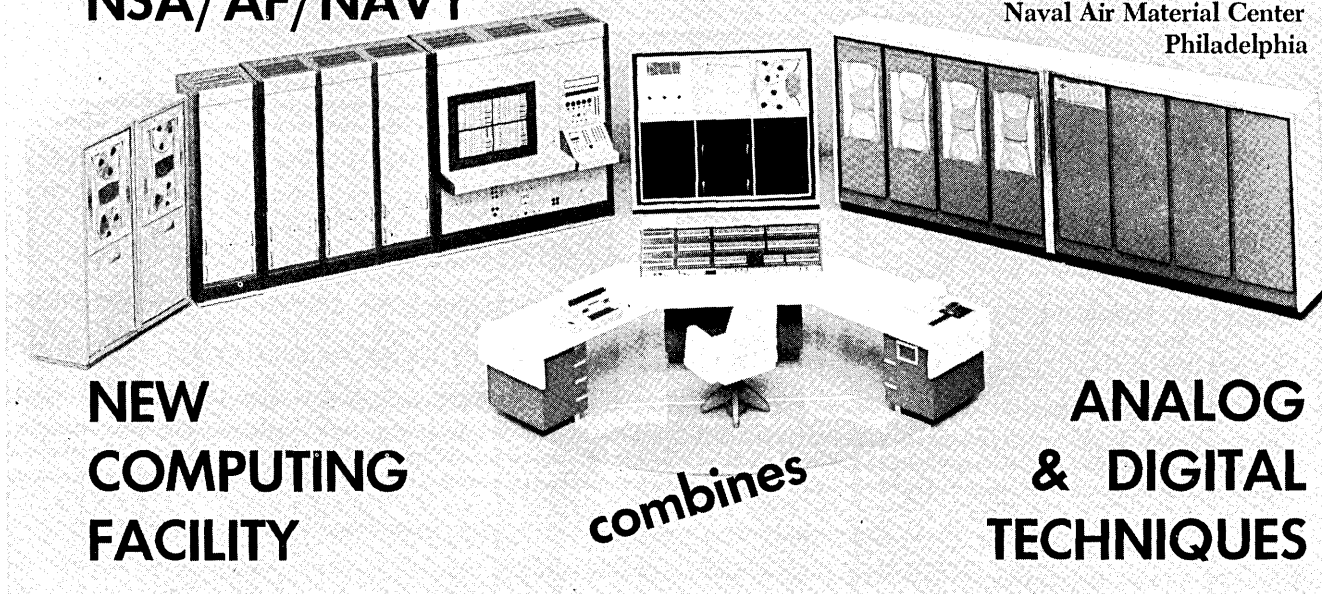

NEW COMPUTING FACILITY

combines

ANALOG & DIGITAL TECHNIQUES

Equipment models (l-r): Ampex tape, EASE computer, Beckman 210, CDC 1604. Console (foreground) is part of 1604.

RAW DATA is generally in the form of analog signals. "Processed data," on the other hand, is usually digital. In the design of almost every data-processing system, therefore, a decision has to be made on the exact point at which the data is translated from analog to digital. And all too often the decision is biased by the manufacturer's background. If the weight of experience has been in computation, digital techniques are preferred; if in instrumentation, analog is the choice.

Occasionally, however, we have had an example of the benefits that can result when the requirements of the problem, rather than the proprietary interests of an individual manufacturer, dictate the form of the data processing system. One such example is the new facility now being established under the direction of the Aeronautical Structures Laboratory, Naval Air Material Center, at the engineering research division of a leading Eastern University. The program is a joint project of the National Aeronautics and Space Administration, the U.S. Air Force, and the U.S. Navy, and is designed to provide statistical information concerning maneuver loads which will be used to establish realistic load criteria for the design of aircraft and components.

Since an aircraft can perform an almost infinite variety of maneuver combinations, a large amount of raw data must be obtained, processed, and reduced to relatively few facts and figures. Extensive data reduction is therefore immediately implied, requiring an absolute optimum use of both analog and digital data-reduction techniques.

The government agencies involved in the program first conducted several extensive theoretical and feasibility studies. From this came a rough "system concept," which was implemented by close coordination between the several equipment builders brought into the project. As a result, the new facility — to be one of the largest data-processing installations on the East Coast — is an **integrated** analog and digital unit that takes full advantage of the benefits of both techniques.

eight parameters

System planning started, of course, with the phenomena to be recorded and the data to be processed.

A special NASA panel recommended that the services initiate a coordinated statistical loads program, based on

time histories of eight flight parameters — three consisting of linear accelerations, three involving angular rates, plus air speed and altitude. In terms of actual measurements, this requires processing the analog values of impact pressure, static pressure, normal load factor, transverse load factor, longitudinal load factor, yawing angular velocity, rolling angular velocity and pitching angular velocity.

in-flight recorder

To record these values, a special flight recorder system was developed by the Emerson Research Laboratory in Silver Springs, Maryland and the Technical Products Division, Jersey City, N.J. (both divisions of the Emerson Radio and Phonograph Corporation). This unit includes four potentiometric sensing devices: a three-component linear accelerometer, a dual-pressure transducer, a dual-axis rate gyro (for pitch and yaw), and a single-axis rate gyro (for roll).

The eight outputs feed through bridge circuits, contained in a compact, 21-pound recorder package, to recording heads. The signals are recorded (perpendicular reading is used) directly onto metal tape, with no amplification or other processing (the recorder contains no active elements such as transistors, magnetic amplifiers, or electron tubes). Since the unit does not have a capstan, the tape speed past the recording heads varies 0.027 to 0.050 inches per second during 50 hours of recording. The tape and record play-back heads are installed in a replaceable magazine. The recorder is started and stopped by either a manual pilot control, or through operation of some function of the aircraft such as retraction of the landing gear.

The metal tape carries nine channels of information, recorded in parallel. Eight of these channels carry the analog data noted above. The ninth channel is used to record a 10-second square wave generated by the recording mechanism. This signal provides timing information that automatically compensates for any change in the speed of the tape past the recording head. In addition, the square wave acts as an amplitude reference for all eight analog signals. When the recorder is first switched "on," a built-in self-calibration circuit establishes the zero and full scale levels by generating a ten-second signal at zero level, followed by a ten-second pulse of full-scale current.

Current drain of the recorder is 125 ma. at 28 volts DC and 170 ma. at 115 volts, 400 cps. The overall dimen-

Combining Analog & Digital

as the Digital Tape Preparation Unit. If any of the (19 or 23) variables issuing from the analog computer are above-threshold, all are sampled by the system at rates from 500 samples per second per channel down to 62.5 samples per second per channel, depending on the playback ratio. In addition, two pre-set digital values are introduced to the Model 210, resulting in a frame of 25 samples. If a below-threshold condition exists, only three analog channels are sampled. These, with two digital channels, produce a frame of 5 samples. The three quantities digitized in the below-threshold mode are equivalent air speed, mach number, and the pressure altitude.

The analog signals are converted to a nine-bit binary number plus sign at the output register of the Beckman 210's analog-to-digital converter. The nine-bit binary number, sign, and the above-threshold indicators are then presented as two seven-bit characters to a magnetic core buffer store. Each of these characters has a parity bit associated with it. The buffer store has a capacity of 2,184 such characters. The store is necessary since the digitizing rate is not fixed; thus it is not related to the magnetic tape write speed which is the final store for the digital information. Rather, the digitizing rate is a function of the playback ratio and the above-or-below threshold condition. When sufficient information to produce a tape record has been deposited in the core buffer, the store can be unloaded onto the magnetic tape. Loading and unloading operations of the store can continue together since the load-and-unload operation is interlaced.

The digital magnetic tape unit is an IBM 729-II. Recording is done at a density of 555.5 bits per inch with a tape speed of 75 inches per second. Thus, the tape write speed is at a rate of 41,670 characters per second. The maximum digitizing rate is 12,500 per second, which gives a character rate to the buffer store of 25,000 per second. The IBM 729 writing rate is therefore sufficiently high so that the buffer store is never in danger of overflowing. When approximately 2,100 characters and longitudinal parity is written, an inter-record gap is made. The tape then stops and waits until sufficient data is stored to write another record.

The entire data processing facility, which includes the analog tape units, the analog computer, digital tape preparation unit, and a Control Data Corporation 1604 digital computer, will have a number of digital tape transports associated with it. A switching mechanism will be provided for connecting newly prepared digital tape to the digital computer. Another transport will then be switched to the digital tape preparation unit so that processing may be continuous with manual handling of tape reduced to a minimum.

digital computation

The 1604 then performs statistical analyses on all of the data received from the EASE analog computer. There will be a nearly continuous input of digital data to be analyzed, and several statistical as well as validation files developed.

The 1604 selected for the joint program presents this profile: the basic 1604 computer with 32,768 48-bit words of magnetic core storage and a panel displaying translated contents of all operational registers projected in Arabic numerals in the Octal system. The unit includes fixed and floating point arithmetic, indirect addressing, control and maintenance console, paper tape reader and punch, and input/output typewriter.

IBM 729-II magnetic tape handlers will be used as the

main input-output equipment. These read and write at 200 or 556 characters per inch. The tape speed is 75 inches per second, making the character transfer rate either 15 kc. or 41.16 kc. They are equipped with dual-head sensing features so that the quality of a write operation can be immediately checked for readability. These units are connected to the 1604 through a CDC 1608, which contains the assembly and disassembly registers for making groups of eight characters into 48-bit words for parallel transfer to storage and vice versa. The facility will have two 1608's, each connected to a separate pair of input-output channels so that it is possible to be reading or writing on two tapes simultaneously.

In the 1604 input-output, operations are carried out independently of the main computer program and the input-output section of the 1604 contains the facility for several modes of communication.

The internal memory of the 1604 is a magnetic core storage system providing random-access storage for 32,768 48-bit words. One 48-bit word may contain either a 48-bit data word or two 24-bit instructions. The read access time is 2.2 microseconds. The average effective cycle time for random addresses is about 4.8 microseconds for a representative program. The 1604 instruction repertoire contains a list of 62 instructions which expand into many sub-instructions.

The Control Data 1608 adapter permits communication between the 1604 computer and any of the following IBM peripheral equipment: 729-II Magnetic Tape Units, 1401 computer, and 1402 read and punch equipment. Each 1605 Adapter can be connected to any of the three buffer input channels and three buffer output channels, and each 1608 is independently addressable.

peripheral equipment

The facility will have an IBM 1401 system. This consists of computer, printer and card reader, and punch. The equipment is particularly well adapted for editing the output of large-scale, high-speed systems and either writing it on another tape, punching cards, or printing it. It can also be used to read data on cards, edit into a good format, and write it on tape for entry into the large system. In this way, card data may be moved in a computer at a rate appropriate to its capability. The 1401 will also be used for preliminary screening.

looking ahead

The results to be expected from this program and facility are two-fold: The first is structural, which is the primary goal of the study, and the second methodological. From the results of the advanced statistical analysis and data gathering program, we will develop greater confidence in knowing what loading environment can be expected for various aircraft types. With this new knowledge, improved air frame design will be possible. Designs will then be possible which feature the lightest structure consistent with adequate fatigue strength.

In addition, the fact that both analog and digital equipment will be used on the same data will produce new techniques and experiences in this mixed area. For example, the subject of digital computer computation for the programming of analog computers will be studied.

Further information on the general area of the division of effort between analog and digital equipment on the same problem will be obtained. Finally, the fact that the 1604 produces a tape that can be read by the EASE gives a closed analog-digital system, albeit a weak one, and any control other than potentiometer setting involves a human in the control loop.

FOR BECKMAN, CIRCLE 130 ON READER CARD

FOR CONTROL DATA, CIRCLE 131 ON READER CARD

FOR IBM, CIRCLE 132 ON READER CARD

FOR AMPEX, CIRCLE 133 ON READER CARD

General Electric Computer Department

Embarks on Vigorous New Program

in Industrial and Commercial Computers

It is estimated that the next 2 years will see a 33% increase in non-military use of computer equipment. We are meeting these projected needs with a vigorous program of design, applications and sales. The first steps are 1) G.E.'s new 225 computer system for large and small scale application; 2) a significant expansion of our sales structure right now.

We are now conducting a successful operation, and anticipate tremendous growth and capture of an even larger share of the market. Since we have set out to establish leadership and accelerate growth, the men we add to our staff must be of the highest competence. For these men, the market situation in which we are operating means that there will be plenty of technical challenge and, right with it, room for rapid personal advancement as we expand.

A substantial range of opportunities is now available in Phoenix, Arizona and Palo Alto, California.

Phoenix

Computer Systems Design Engineers

EEs and MEs—plus experience in computer or electronic systems design. Advanced systems engineering on large and small commercial systems as well as industrial and process control systems:

Logic and Circuit Design
Advanced Systems Evaluation and Analysis
Peripheral Equipment Design
Component Engineering

Palo Alto

Applied Research

... at the Computer Laboratory on projects centering on:

Thin Magnetic Film
Parametric Devices
Pattern and Character Recognition
Advanced Logic and Circuit Design
Magnetics and Optics

Phoenix

Computer Applications

Degree required plus 2-3 years computer programming experience. Equally important as the engineering effort, the application programs offer a wide scope of opportunity to Programmers and Operations Research personnel. Openings available in the following areas:

Programming Research
Applied Industrial Programming
Business Applications
Computer Techniques and Simulation
Scientific Programming
Operations Research
on Multicomputer Systems

Training in Phoenix; Assignments throughout the U.S.

Applications Consultants

A BS in Business Administration, Math and/or Engineering is required, plus 2-3 years experience in computer programming and systems analysis. Customer consultation on systems analysis and implementation — pre and post order, programming training, new applications of integrated business data processing systems.

Phoenix

Additional Openings In:

Computer Sales
Product Planning
Product Service
Engineering Drafting
Quality Control

*If your experience and interests match any of the above openings, please write in confidence to
Mr. J. E. Torrey, Room 56-MA.*

COMPUTER DEPARTMENT

GENERAL ELECTRIC

P.O. Drawer 270, Phoenix, Arizona

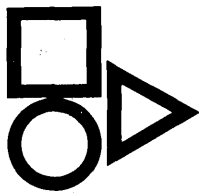

paper tape handler

A new bi-directional perforated paper tape handler permits forward or reverse reading of perforated tape at speeds up to 400 characters per second, and a rewind of 1,000 characters per second. Eight-inch reels, which hold 500 feet of tape, are controlled by a three-zone contractor system which performs the same function as a full servo system, and accepts 5 to-

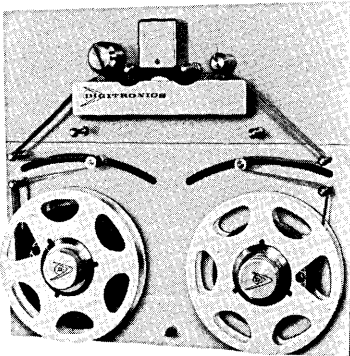

8-level tapes interchangeably. The model 4566 is designed for use with the uni-directional model 3500 or the bi-directional model B3500 high-speed photo-electric tape readers, which can function in the strip mode at 1,000 characters per second. It mounts on standard 19 in. relay racks directly beneath the reader. DIGITRONICS CORP., Albertson Ave., Albertson, L.I., N.Y. For information:

CIRCLE 200 ON READER CARD

transistor tester

A new automatic transistor tester processes every parameter that can be tested at a rate of 750 diodes per hour. It can skip, hold, or delay any or all of the tests. Measurements are made with accuracy of 1%. Programming can be done on a "go-no-go" basis. Only "pass" units remain in the test set. Automatic reject-eject device discharges failures. Optional features include digital read out. Recording of bias setting, parameter reading, and delay between tests can be made on IBM 526 or similar punch cards. CONTRONICS, INC., 37 Leon St., Boston 15, Mass. For information:

CIRCLE 201 ON READER CARD

check digit verifier

The A570 check digit verifier is actually a solid-state electronic computer. It is designed to operate cable-connected to accounting machines that produce tapes for subsequent data processing. A mathematical computa-

tion which the verifier performs instantaneously upon account numbers to be entered into tape ensures the accuracy of each entry. The verifier virtually eliminates the chance of wrong account numbers being keyed in by an operator by the use of the "double-add-double" calculation. Variations on the double-add-double calculation may be used to arrive at the check digit, but the principle remains the same. BURROUGHS CORP., Equipment & Systems Divisions, Detroit 32, Mich. For information:

CIRCLE 202 ON READER CARD

module extractor

The model 84 module extractor is designed to facilitate the removal of 300 series card modules from the 80-320 series of mounting racks. In the series of printed circuit modules the front pull bracket is designed to serve both as a pull handle and as a means of mounting indicators, push-buttons,

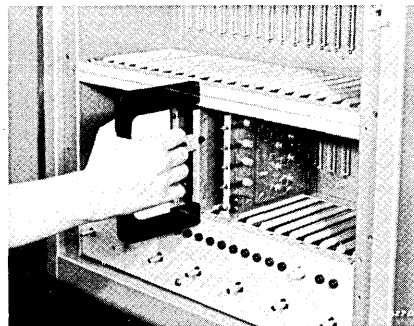

switches, etc. The modules are mounted at 13/16 centers to derive the greatest possible packing density, and the spacing between modules is arranged to be just big enough to insert the tips of the fingers, for grasping the pull handles. NAVIGATION COMPUTER CORP., 1621 Snyder Ave., Philadelphia 45, Penna. For information:

CIRCLE 203 ON READER CARD

analog computer

A new analog computer operates at much slower speeds than most analog instruments. Now used with a spectrophotometer, it enables simple, precise measurement of the special distribution of radiation emitted, transmitted, or reflected by materials. The new computer shows promise for use in the measurement of the sunlight conversion efficiency of solar cells. The computer is designed to compensate for variations in a spectrophotometer that arise from differences in the frequency characteristics of

various light paths through the machine optics. This normally complicated process becomes a relatively simple comparison technique with the computer. HOFFMAN ELECTRONICS CORP., 3761 S. Hill St., Los Angeles 7, Calif. For information:

CIRCLE 204 ON READER CARD

digital tape handler

A new digital magnetic tape handler is designed to be compatible with any of eight different computers. The compatible equipment consists of a tape handler and a field conversion kit that adapts the handler for use with a specific computer. The equipment will be used in the Air Force's combat logistics network, which will link some 450 USAF installations with 5 data processing centers. The centers will use RCA computers, but each of the outlying stations will use any of the 8 different computers. These compatible tape handlers will be part of a Comlognet subsystem which is a specialized complex for translating data from one computer into a form acceptable by the data processing center. POTTER INSTRUMENT CO., INC., Sunnyside Blvd., Plainview, N.Y. For information:

CIRCLE 205 ON READER CARD

multichannel heads

A new series of basic multichannel heads provides for simultaneous recording of up to 20 channels per inch on tape or drum. A choice of track

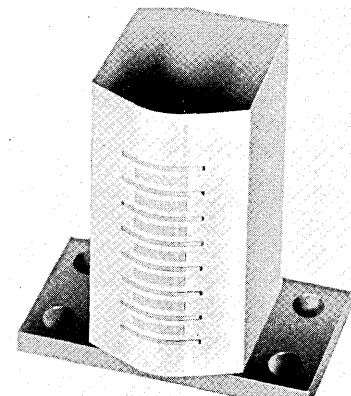

formats and electrical characteristics satisfy the requirements of the most exacting analog and digital recording applications. Designated as the 4000 series, it is available in six compatible track formats. Timing accuracy of recorded information between channels is assured by maintenance of colinearity of leading and/or trailing edges of

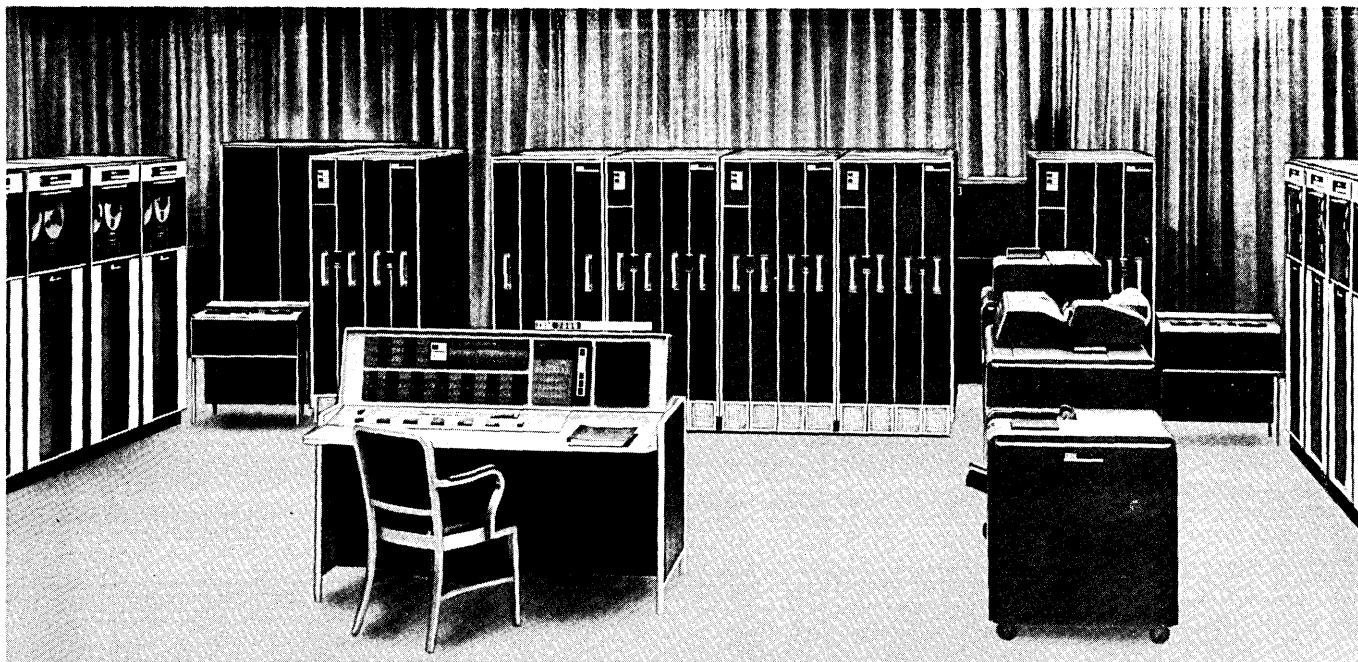

*If you're going to buy
COMPUTER time, it will
pay you to use the best...*

Here's how to put the efficient new IBM 7090 computer to work for you . . . at less cost than you may have thought possible.

You can rent a new IBM 7090 computer with 10 on-line tape drives, and two data channels in a new Data Processing Center in Cambridge, Massachusetts . . . at a \$450 hourly rate. Prime shift rate is \$550 hourly. (Special rates for university level non-sponsored research.)

Note that the rental rate is comparable to that being asked for the "old" IBM 709 and 704. Yet the new 7090 is five and six times faster. Processing can be accomplished in a fraction of the time.

You will find the savings considerable.

In addition to the 7090, the following services are provided without charge:

1. Equipment operation by experienced personnel.
2. Up to date utility systems and consultation services.
3. Cards, paper, magnetic tape supplied free.
4. Programming assistance for converting programs to the 7090.
5. Use of extensive program library.
6. Mail service — work requests accompanied by programs received by mail will be carried out and returned as specified.

Here's all you do: for full details on the new IBM 7090 Data Processing Center, (the only one of its kind in New England) just write:

COMPUTIME
Sales company
60 GARDEN STREET, CAMBRIDGE, MASSACHUSETTS — PHONE: UNIVERSITY 4-7090

*How to get the most from
the IBM 7090*

CSI's staff of programming and operational personnel, with extensive experience on the IBM 704 and 709 computers, will insure your efficient use of this Data Processing Center.

Complete programming assistance is available through Computer Services, Inc., parent company of Computime . . . whether the problem is modifying an existing program for use with the 7090; re-programming; or formulating and programming of new applications.

CSI specializes in the design, analysis, evaluation, and programming of digital data processing and control systems.

Whatever your data processing problem, chances are excellent that CSI's complete range of services can ease your burden — and save you time and money:

DATA PROCESSING SERVICES

Systems Analysis, Programming, Operation: CSI's Data Processing Division provides complete analysis from formulation and programming to data preparation and computation. In addition to the new Cambridge Computer Center, CSI operates a fully staffed and equipped data processing center at its Englewood, N. J. facility.

SYSTEMS ENGINEERING

Special Purpose Equipment and Prototype Development: CSI can meet your needs for development and production of special purpose equipment with any or all of these services: systems analysis and design, logic and circuit design, prototype development and manufacturing.

FOR COMPLETE INFORMATION on CSI's complete range of data processing services, write:



**COMPUTER
SERVICES INC.**

25 HONECK STREET, ENGLEWOOD, NEW JERSEY — Phone: LOWell 8-0662

NEW!

Solid State DISPLAY ASSEMBLY

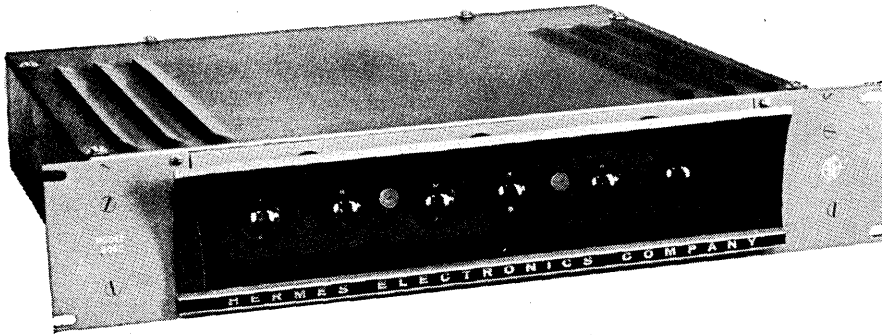

for decimal display
and storage of
binary coded
decimal data

accepts up to 24 bits of parallel BCD data

Hermes' new Solid State Display Assembly, Model 2060, is designed for use in any system requiring presentation in decimal display of a BCD parallel signal. For example, Model 2060 permits direct reading of Angular Shaft Encoders with BCD parallel output. Model 2060 accepts up to 24 bits of parallel BCD information in any of the following 4-bit Codes: Binary Code Decimal (1-2-4-8); Gray Code (Cyclic Code); Decade Counter Code (1-2-2-4) or (1-2-4-2); Binary Complement Coded Decimal; Binary Two Out of Five Code; Binary (1-2-4-7).

These signals are converted to 60-line decimal display using Burroughs-type Nixie tubes. Binary input to Model 2060 may be either static or parallel pulses.

Storage capability which can conveniently be retrieved through a multi-pin connector is provided in the converting circuitry. Converter Boards can be furnished which accept up to six bits of parallel information, converting to two decimal displays. Write for *Technical Bulletin 2060*.

Hermes



ELECTRONICS CO.

75 CAMBRIDGE PARKWAY, CAMBRIDGE 42, MASS.

A DIVISION OF

Itek

CIRCLE 18 ON READER CARD

NEW PRODUCTS . . .

gaps to plus or minus 0.000050 in. within the head stack. BRUSH INSTRUMENTS, 37th and Perkins, Cleveland 14, Ohio. For information: CIRCLE 206 ON READER CARD

translator-converter

A low cost system for high speed translation of paper tape codes and conversion of information between IBM cards and tape has been developed. The model 312 translator uses two standard instruments, a tape reader and a tape perforator, for tape to tape translation. For card-tape conversion, the system is linked through



its logic section to an IBM type 024-026 keypunch. All logic and control functions are performed by logic switch elements. The system performs paper tape code-to-code conversion at 60 tape characters per second. For tape-to-card or card-to-tape conversion, speed is approximately 20 card columns per second. TALLY REGISTER CORP., 1310 Mercer St., Seattle 9, Wash. For information: CIRCLE 207 ON READER CARD

magnetic tape search units

A series of manual magnetic tape search units for use with codes generated by time code generators is designed to operate in conjunction with four frequently specified time code generators. The ZA-841 reads time code as supplied by the ZA-801 24-bit BCD time code generator. The ZA-842 reads time code supplied by the 17-bit binary time code generator, ZA-802. The ZA-843 reads the time code of the 20-bit binary ZA-803 time generator. The ZA-850 is designed to

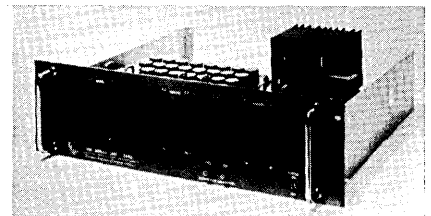

DATAMATION

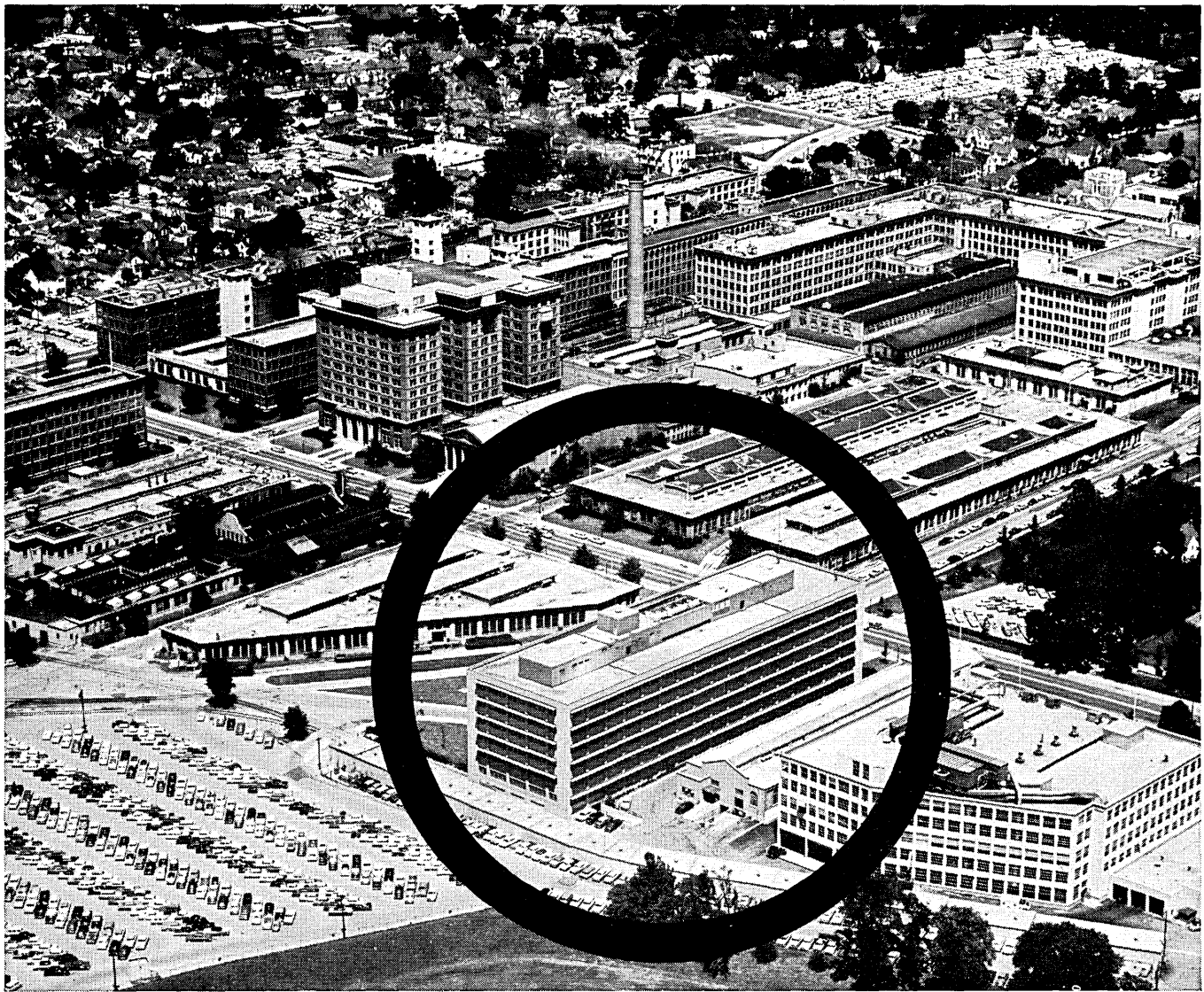

FOCUS ON RESEARCH

the first step in progress

Few, if any, organizations offer more challenging opportunity for research and new development work than The National Cash Register Company. Encompassing all sciences, the program at National's Research and Development Center at Dayton, Ohio, is built on the philosophy that Progress is limited only by man's imagination... that research is the first step in Progress. Perhaps your opportunity rests with us in one of the following areas:

- ON-LINE COMPUTER SYSTEMS
- SEMI-CONDUCTOR RESEARCH
- LOGICAL and CIRCUIT DESIGN
- MILITARY RESEARCH & DEVELOPMENT

Openings in the above areas of work are at an advanced level and require direct experience and an appropriate degree up to Ph.D. level.

THE NATIONAL CASH REGISTER COMPANY, DAYTON 9, OHIO

ONE OF THE WORLD'S MOST SUCCESSFUL CORPORATIONS

77 YEARS OF HELPING BUSINESS SAVE MONEY

CIRCLE 74 ON READER CARD

FOR FULL CONSIDERATION, simply send your resumé to Mr. T. F. Wade, Technical Placement Section G-14, The National Cash Register Company, Dayton 9, Ohio. All correspondence will be kept strictly confidential.

® TRADEMARK REG. U.S. PAT. OFF.

*National**

**ELECTRONIC DATA PROCESSING
DIVERSIFIED CHEMICAL PRODUCTS
ADDING MACHINES • CASH REGISTERS
ACCOUNTING MACHINES • NCR PAPER**

Senior Methods Analysts, Scientific Applications Specialists, and Sales Representatives

GIVE YOUR CAPABILITIES FULL EXPRESSION — AT A LOCATION OF YOUR CHOICE —WITH RCA'S EDP DIVISION

There's an atmosphere of achievement at RCA. You become associated with other highly capable people working on important projects. You are stimulated to contribute your best... and your accomplishments are recognized and rewarded.

You're a vital member of a company whose equipment is universally accepted and respected... a company that's growing... expanding its EDP offices and facilities throughout the country. Because of this, you're able to choose your own location.

The qualifications required: for *Senior Methods Analysts*, an extensive background in EDP systems analysis and a knowledge of programming methods and planning. For *Scientific Applications Specialists*, a minimum of three years' experience in scientific computations on EDP tape equipment, *plus* systems experience.

For *Sales Representatives*, a background that includes at least one year of on-quota EDP sales experience with either government or commercial clients, and a thorough EDP systems knowledge.

Call or send your résumé to the nearest RCA Electronic Data Processing Division office for confidential consideration of your qualifications:

Mr. R. W. Baumann, Pers. Mgr.,
Northeastern Reg.
45 Wall Street
New York, 5, New York
HAnover 2-1811

Mr. R. C. Mercer, Pers. Mgr.,
Cent. & Southeastern Reg.
RCA Cherry Hill, Bldg. 204-1
Camden, 8, New Jersey
WOOdlawn 3-8000,
Ext. PY 5444

Mr. R. W. Stephens, Pers. Mgr.,
Western Reg.
11819 W. Olympic Blvd.
Los Angeles, 64, Calif.
BRadshaw 2-8842

Mr. M. G. Young, Pers. Mgr.,
Fed. Gov't Sales
1725 K Street, N.W.
Washington, 6, D.C.
FEderal 7-8500



The Most Trusted Name in Electronics

RADIO CORPORATION OF AMERICA



CIRCLE 75 ON READER CARD

NEW PRODUCTS . . .

read time code from the ZA-810 time code generator which produces a 36-bit BCD days, hours, minutes and seconds, code. ELECTRONIC ENGINEERING COMPANY OF CALIFORNIA, 1601 E. Chestnut Ave., Santa Ana, Calif. For information:

CIRCLE 208 ON READER CARD

digital modules

Featuring two to four times the circuit density of previously available units, a new line of low cost 200-kc digital modules are contained on 4 in. by 4 in. glass based printed circuit cards incorporating a 35-pin connector. Four identical but independent flip-flop circuits are provided on the model TF-101, typical of the circuit

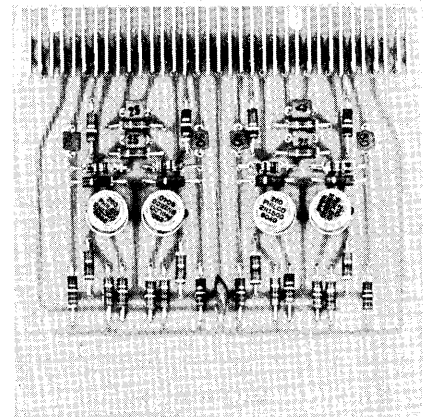

density achieved in the new line. Each flip-flop includes set and reset diodes plus AND gates for use as a binary counter or shift register. Additional circuit configurations offered on other models include gate drivers; diode gates; input gates; Nixie drivers; and transistor drivers. PACKARD BELL COMPUTER CORP., 1905 Armacost Ave., Los Angeles 25, Calif. For information:

CIRCLE 209 ON READER CARD

storage system

A new system introduces a magnetic drum which stores more information than any other in existence, according to the manufacturer. Each storage unit, designed for use with Univac solid-state and STEP computers, is comprised of two drums capable of containing 24,000,000 digits and signs.

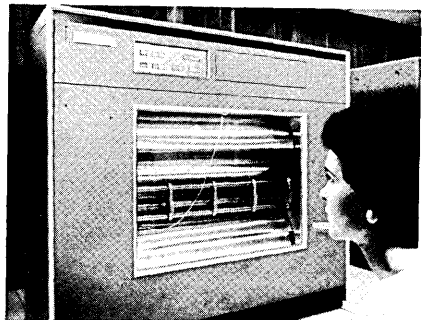

The system can be expanded to as many as 10 storage drums. The steps involved in feeding a source document into the computer system to the issuance of the final invoice are reported to be greatly simplified. While processing takes place, every file affected by the transaction is internally updated automatically. REMINGTON RAND, 315 Park Ave., South, New York 10, N.Y. For information:

CIRCLE 210 ON READER CARD

block tape reader

A new block tape reader has a capacity for reading up to 32 or more lines of coded material in a 5, 6, 7, or 8 channel tape. The new reader has a brush head which retracts when the combination cover and common

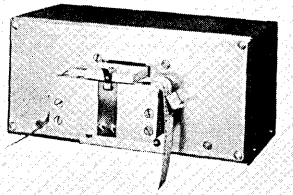

collector plate is lifted. Thus, the possibility of physically damaging the brushes when replacing tapes is eliminated. The design has also been utilized to allow for more rapid assembly. WANG LABORATORIES, INC., 12 Huron Ave., Natick, Mass. For information:

CIRCLE 211 ON READER CARD

data systems

Available in a wide variety of input-to-output combinations, the model 210 data system can be utilized as a basic translator. Functional modules, in the form of direct-coupled logic cards, are incorporated into the system to tailor it to a particular application. Input-to-output variations include: magnetic tape-to-magnetic tape, magnetic tape-

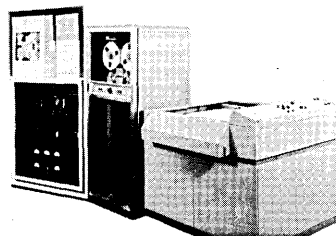

to-punched tape, punched cards-to-magnetic tape, magnetic tape-to-plotter, and punched tape-to-magnetic tape. Applications include the graphical presentation of any information most conveniently stored on magnetic tape in digital computer format. BECKMAN SYSTEMS, 325 N. Muller, Anaheim, Calif. For information:

CIRCLE 212 ON READER CARD

magnetic tape cleaner

A new magnetic tape cleaner is adjustable from 0-300 feet per minute,

DEC BUILDING BLOCK LOGIC KIT



Includes everything needed to perform a wide variety of logical operations

Now Digital offers a basic selection of 500 kilocycle logic circuit packages which can be used to design, test and demonstrate up counters, down counters, four-bit shift registers, decimal decoders, Gray-to-binary decoders, two-binary-digit adders and subtractors, and other similar digital pulse apparatus.

Graphic front panels (a Digital first) permit all logical interconnections to be made quickly and easily by means of handy stacking banana-jack patch cords. And the units can be assembled and reassembled in any number of different combinations in the plug-in mounting panel.

Included in the Basic Kit are nine DEC Digital Test Equipment units — one inverter, one diode nor, four flip-flops, one delay, one clock, and one pulse generator — and the necessary accessory equipment — power supply, power cable, mounting panel, and one hundred patch cords. Other Building Blocks from Digital's fully compatible 500 kilocycle, 5 megacycle and 10 megacycle lines can be added to increase the versatility of this unique new kit.



Write for your copy of Digital's popular new logical operations handbook — "DEC Building Block Logic"

Complete Kit (FOB Maynard) \$1038

digital

EQUIPMENT CORPORATION
MAYNARD · MASSACHUSETTS

WEST COAST OFFICE • 8820 SEPULVEDA BOULEVARD • LOS ANGELES 45, CALIFORNIA

CIRCLE 19 ON READER CARD

NEW PRODUCTS . . .

with automatic shut-off that leaves the machine threaded with leader for continuous operation. The operation of the model T-7070 is completely automatic. Once the tape is in place and the solvent tank filled, the cleaner automatically completes all operations. The cleaning action features special protection for valuable tapes by allowing only velvet cotton fibers to contact the tape surface. Cleaners are available for 3/4 in., 1 in., and 2 in. tape. **COMPUTER-MEASUREMENTS CO.**, 12970 Bradley Ave., Sylmar, Calif. For information:

CIRCLE 213 ON READER CARD

data input unit

A new direct entry data input unit is adaptable to all types of systems. The compact keyboard unit is easily in-

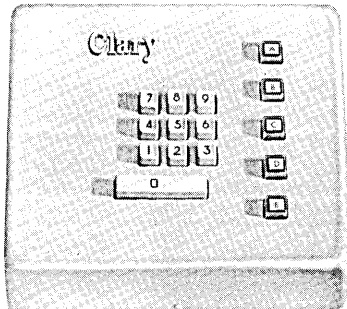

tegrated with any computer or digital instrument, data-logging, checkout, testing and other systems and can be used with tapes, both punched and magnetic or cards. It is applicable to remote control operations. The unit features a 10-key keyboard and can accommodate from five to 30 control keys. Indicator lights are available for special applications. The simplified unit, which stresses flexibility and reliability, can be integrated into existing systems without outside technical assistance. **CLARY CORP.**, 408 Juniper St., San Gabriel, Calif. For information:

CIRCLE 214 ON READER CARD

Facitape

Facitape, a new advance in the computer accessory field, is produced in three models: a tape reproducer which can duplicate punched paper tapes at the rate of 150 characters per second; a tape translator which reads punched tapes at the rate of 600 characters per second and a combination of the reproducer-translator equipment in a tape console. The equipment can be used separately or in combination. The new equipment may be adapted for both on and off-line applications and is compatible with virtually any present type of computer. It can be used with data loggers, plotters, typewriter punches, present paper tape

reproduction equipment and numerically controlled machine tool equipment. One of its features is that it uses a capacitance reader instead of the more common photo-electric and mechanical readers used with most computing equipment. **AUTONETICS**, 9150 E. Imperial Highway, Downey, Calif. For information:

CIRCLE 215 ON READER CARD

portable tape unwinder

A new, portable tape unwinder eliminates manual rewinding and holds a 12 in. reel of up to 1,300 feet of chadless tape or up to 2,000 feet of fully perforated tape. It feeds the leading

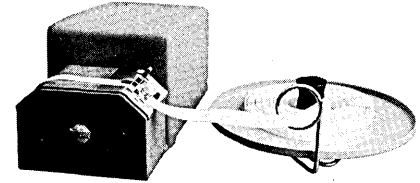

end of the tape from the center of the roll into a teletypewriter transmitter. The unwinder weighs 1 1/2 lbs and is 5 in. high, 12 1/2 in. wide. **WESTERN APPARATUS COMPANY**, 5600 Jarvis Ave., Chicago 48, Ill. For information:

CIRCLE 216 ON READER CARD

analog computer

A transistorized, "do-it-yourself" special purpose analog computer will perform a variety of laboratory, engineering and process control computing tasks. The TR-5 mounting unit makes it possible for computers to be assembled easily and without the problems associated with such a project. The TR-5 contains all the controls necessary to operate a 20-amplifier computer. The basic unit will house up to six computing components and a fully-transistorized power supply. It may be expanded to large-computer capability by adding up to two expansion units to the basic rack. One expansion unit, the TR-1, is prewired to accept an additional five dual transistorized amplifiers. Additional space is available, but not wired, for five more dual modules or ten single modules for the addition of assorted linear or non-linear computing components. **ELECTRONIC ASSOCIATES, INC.**, Long Branch, N.J. For information:

CIRCLE 217 ON READER CARD

A new digital data modem transmits up to 5400 bits-per-second over telephone or telegraph lines. The new modem is capable of full-duplex operation, or transmitting and receiving simultaneously. At maximum data rates, this means that it can transmit and receive 5400 bits-per-second simultaneously in each direction. The

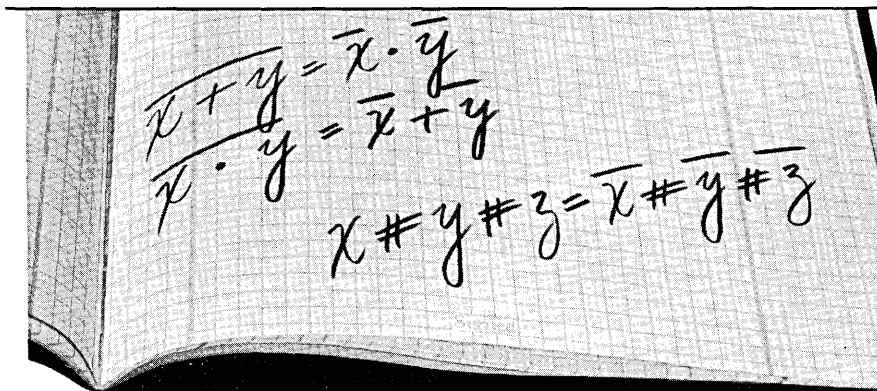

These two familiar Boolean equations (known as DeMorgan's Laws) reduce to a single statement in a new logical algebra, called Majority Decision Logic. This new threshold type

algebra has been discovered and formulated in the Mathematic and Logic Research Department at Remington Rand Univac.

Univac now has a number of opportunities for participation in exceptionally interesting projects which offer both professional and personal reward. These positions are significant in their potential for advancement. The following are among those openings immediately available to experienced, capable people:

**COMPUTER APPLICATIONS ANALYSTS
MILITARY SYSTEMS ANALYSTS
BUSINESS SYSTEMS ANALYSTS**

**COMPUTER PROGRAMMERS
COMPUTER LOGICAL DESIGNERS
ENGINEER WRITERS**

Send resume of education and experience to:

R. K. PATTERSON, Dept. I-1

Remington Rand Univac

Division of Sperry Rand Corporation • 2750 West Seventh St. • St. Paul 16, Minn.

There are also immediate openings in all areas of digital computer development at our other laboratories. Inquiries should be addressed to:

**F. E. NAGLE, Dept. I-1
REMINGTON RAND UNIVAC
1900 West Allegheny
Philadelphia 29, Pennsylvania**

**D. CLAVELOUX, Dept. I-1
REMINGTON RAND UNIVAC
Wilson Avenue
South Norwalk, Connecticut**

When responding, a mention of DATAMATION would be appreciated.

AN/GSC-4 operates over voice quality lines and includes such features as variable data transmission rates, ability to transmit parallel or serial synchronous data and to transmit several types of data simultaneously. COLINS RADIO CO., 2700 W. Olive Ave., Burbank, Calif. For information: **CIRCLE 218 ON READER CARD**

filaments and boats

A new complete line of tungsten, tantalum and molybdenum filaments and boats are now available in a variety of sizes and shapes and are being manufactured for use in high vacuum as an evaporation source. All parts are stress relieved to obtain the longest

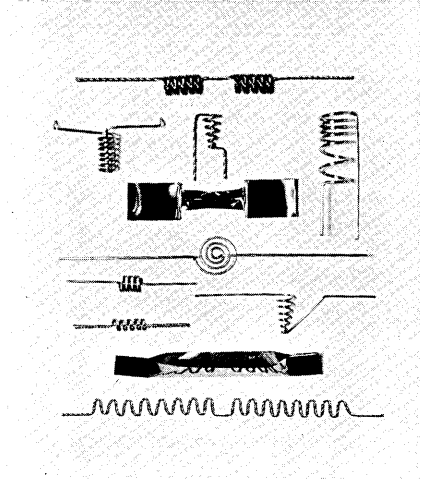

possible life in operation, and to maintain their geometry during use. Primary uses for these filaments and boats include: electronic component processing, coating of optics, precision instrumentation manufacturing, and vacuum metalizing in basic research laboratories. ALLEN-JONES, INC., Electronics Division, 1345 Gaylord Ave., Long Beach, Calif. For information:

CIRCLE 219 ON READER CARD

electronic multiplier

A new electronic multiplier, designated as the model 3735, offers quadrant multiplication and squaring with accuracies of 0.01%. Four quadrant multiplication accuracy is 0.05% full scale. Completely compatible with all analog computers, it requires no external power supplies or amplifiers to work with any make of analog computing equipment. The unit can also be used on analog data and process control systems. Other features include built-in division and square-root operation and modular construction with plug-in printed circuit cards. DONNER SCIENTIFIC CO., 888 Galindo St., Concord, Calif. For information:

CIRCLE 220 ON READER CARD

solid state converter

A new completely solid state tape-to-card converter has been developed which includes main power switch with lamp indicator, start and stop

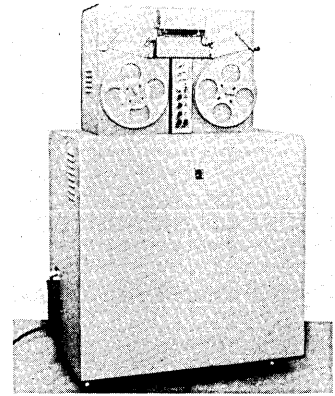

buttons, runout button to feed the tape by block lengths without reading, and error sensing lights. Basically a block tape reader and decoder, a complete system consists of the type 55 tape-to-card converter and a standard summary punch. The tape-to-card converter control panel includes main power switch with lamp indicator, start and stop buttons, runout button to feed the tape by block lengths without reading, and error sensing lights. The functional components consist of the block tape reader, a decoder, and storage matrix, interlocking control relays, necessary manual controls and a power supply. TELECOMPUTING CORP., 12832 Saticoy St., North Hollywood, Calif. For information:

CIRCLE 221 ON READER CARD

ASTRO DIVISION

NEEDS A

DATA SYSTEMS ENGINEER

To devise problem solving signal processing systems utilizing the unique capabilities of a new large storage random access memory system. Position responsibilities also include study of methods of mark-coding for optimum information storage, and study of logical methods for adapting a multi-channel memory system to specific applications.

Qualifications include M.S. or Ph.D. in EE, Physics, or Math. Should be experienced in computer memory, computer logic, information theory, signal processing concepts, signal cross-correlation techniques, statistical data processing, or analog-digital data processing techniques.

Direct Inquiries To:
Floyd E. Hargiss
Professional Personnel

THE MARQUARDT CORPORATION

16555 Saticoy Street
Van Nuys, California
CIRCLE 78 ON READER CARD

COMPUTER SERVICES

You can solve your computer problems quickly and economically by using our 32K-word storage IBM 704. Whether you need long or short runs, they can be readily scheduled on our machine at the same attractive rate for every shift—**\$275 per hour**, including all peripheral equipment and operators.

Bring your program and work in our Client's Room between runs—Or mail us your program with instructions for running it and we will mail back the printout within 24 hours—Or simply leave your entire problem in the hands of our capable mathematical analysts and programmers.

If you need pipe stress, structural stress, flow analysis, or curve fitting, one of our general programs might well be just what you are looking for.

To use our prompt, efficient computer services, write or call us collect, Hilltop 5-4321, extension 1449.

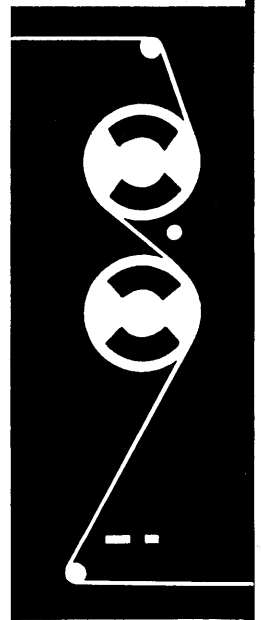

ELECTRIC BOAT GROTON, CONNECTICUT

A DIVISION OF **GENERAL DYNAMICS**

CIRCLE 21 ON READER CARD

Application data on

counting tubes

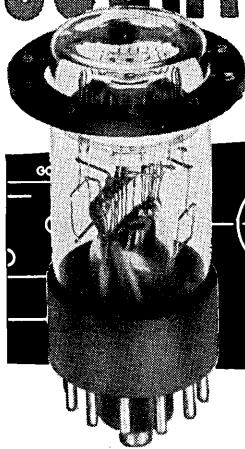

and counting tube circuits

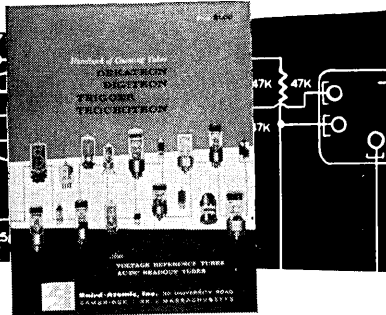

DEKATRON GC10D
Cold cathode glow tube for totalizing, sorting, programming, special computing and control circuits. One of four general tube types, in 25 models.

The only handbook of counting tube applications, circuitry and specifications. Top source for circuit and system designers in all electronic, computer and contract engineering fields.

Write for your copy today.



BAIRD-ATOMIC, INC.

33 university road • cambridge 38, mass.

CIRCLE 20 ON READER CARD

COBOL AT WORK

EARLY IN DECEMBER, two operating computer problems, one from a government agency and one from a large industrial company, were written by RCA and Remington Rand utilizing COBOL. The programs were run on a Univac II and an RCA 501. With minor changes, the programs were then prepared for the other manufacturer's equipment. This is the first time a COBOL program was interchanged by two companies with admitted slight modifications. All reports indicate the experiment was a success.

Charles A. Phillips, director of DOD's Data Research Staff and chairman of the Conference on Data Systems Languages, an independent group formed to work for computer compatibility, commented on the results of the experiment:

"The Executive Committee of CODASYL has witnessed an event which will be recorded as an important milestone in the progress of data processing . . .

"The Executive Committee congratulates Remington Rand and RCA for pioneering in the development of COBOL compilers. We look forward to the completion of similar work by eleven other manufacturers who have under development COBOL compilers for twenty-six makes . . . of data processors."

The problem of diverse languages in computing has been recognized as an acute one for years. The CODASYL program, by no means universally popular, has been the only organized effort to date to overcome this handicap. Other CODASYL committees are currently working on highly sophisticated common language packages.

(In the February issue, DATAMATION will present a complete report on the RCA-Remington Rand COBOL exchange and a commentary on its significance.)

$r = 1.00$
^{1.23}
= RCA IN FLORIDA



RCA SERVICE COMPANY

A DIVISION OF RADIO CORPORATION OF AMERICA

MATHEMATICIANS—STATISTICIANS

equate perfection with

1. Exciting assignments at Cape Canaveral
2. Opportunity for professional advancement
3. Pleasant, relaxing Florida living

IF reliability, validity, and error systems analysis are challenging to you . . .

IF advancing the state of the art in data processing techniques is intriguing to you . . .

IF you've been looking for the "different"—the ultimate in a professional position . . .

IF your field is: Operations Analysis . . . Mathematical & Statistical Techniques . . . Astronomy . . . Computer Applications or Computer Programming . . .

THEN you belong with RCA in Florida! You can make the move *right now* . . . by contacting:

Mr. W. F. Marquette
Professional Placement Director
RCA Service Company, Dept. N-47
Atlantic Missile Range
Mail Unit 114
Patrick Air Force Base, Florida



CIRCLE 77 ON READER CARD

To help men make decisions and exert control

The need for systems to help men make decisions and exert control over vast networks of rapid actions has created a fast-moving information technology. Accepting responsibility for instructing great computers, exploring system roles of men and machines, advancing system research — these are some of System Development Corporation's public interest functions in this new technology. ■ SDC's contributions to Sage and SAC control systems have equipped us for work in world-wide communications, education and medicine, traffic and logistics — for those information systems that will shape our culture. ■ Participation in those fields has produced an interdisciplinary science based in four principal skills: Programming, Engineering, Operations Research and Human Factors. Senior professionals representing these four persuasions are invited to explore participation in our rapidly expanding programs. System Development Corporation, Santa Monica, California, Paramus, New Jersey.

SDC

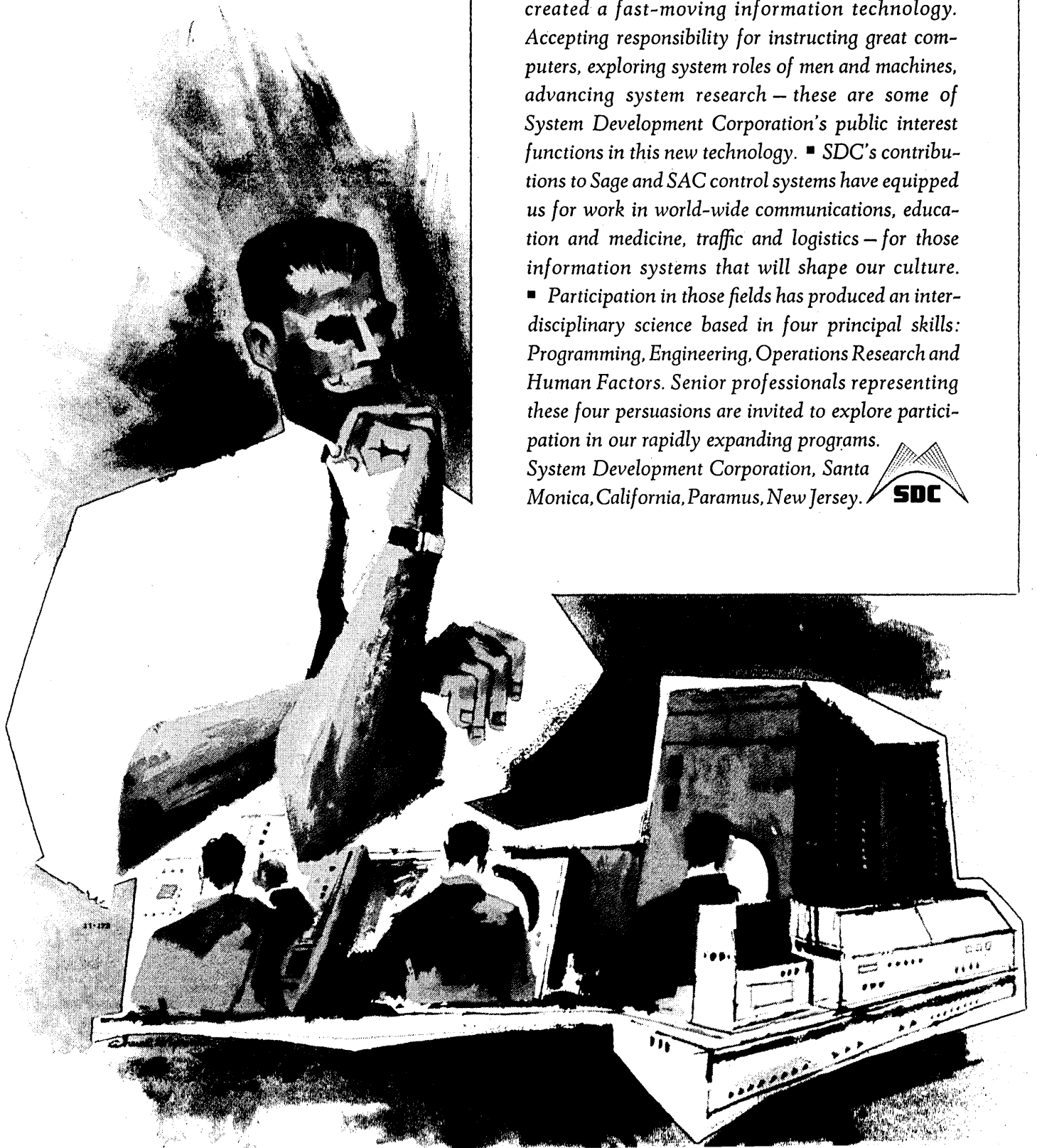

**EACH OF THESE
DRAWINGS, LETTERS
AND FORMS CAN NOW
BE SENT COAST-TO-COAST
IN LESS THAN
4 SECONDS BY
THE STROMBERG-CARLSON
FACSIMILE SYSTEM**

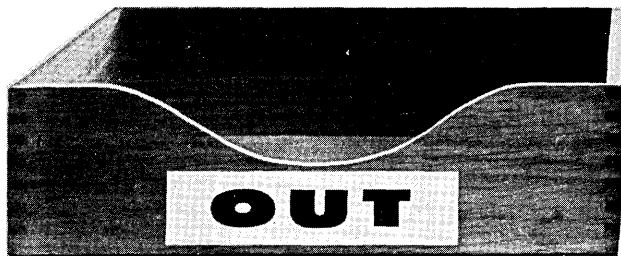

NEW YORK

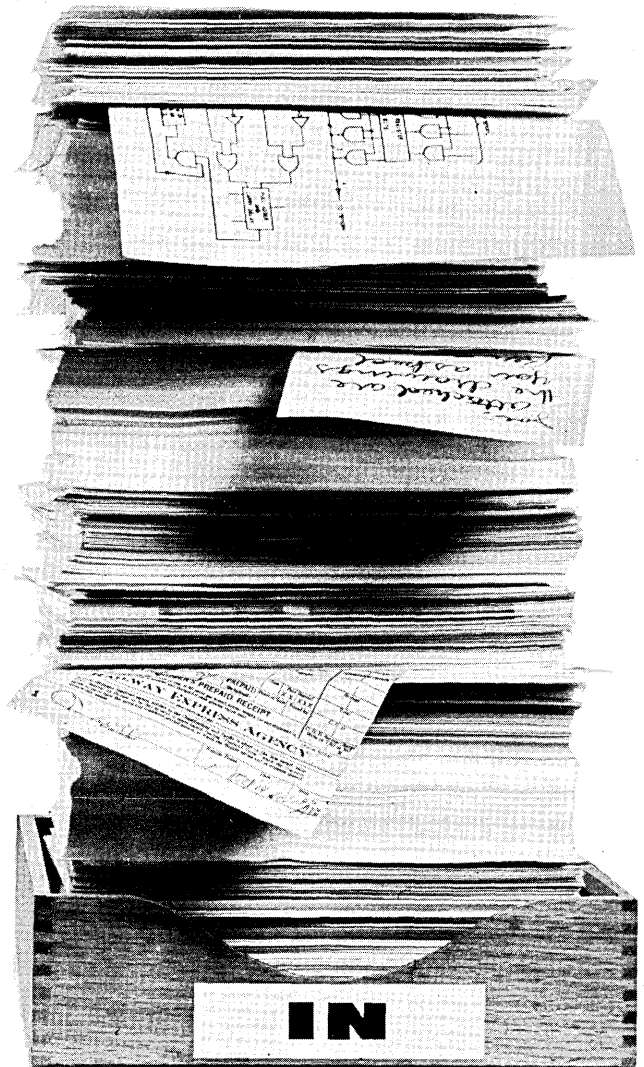

LOS ANGELES

Stromberg-Carlson's new high-speed facsimile printing system now makes it possible to send handwritten or typed letters, printed matter, forms and line drawings great distances, in tremendous quantities at phenomenal speeds. The system delivers an accurate black and white reproduction of an original 8½ x 11" sheet in 4 seconds. Write today for booklet. Stromberg-Carlson-San Diego, Dept. B-10, P.O. Box 2449, San Diego 12, California.



STROMBERG-CARLSON-SAN DIEGO
A DIVISION OF **GENERAL DYNAMICS CORPORATION**

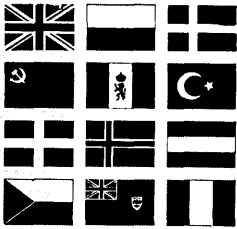

DATAMATION *abroad*

GERMANY

Munich, Germany, will be the site of the second International Federation of Information Processing Societies Congress. The date, September 3, 1962, is significant in that it might have some bearing on the future dates of our Eastern and Western Joint Computer Conferences. See the February issue of DATAMATION for details.

U.S.S.R.

The Soviets have recently developed remote control and remote signaling devices for application in the field of telemetry. A telemetering system operating in Tbilisi converts continuously measured quantities into discrete values, after which they are fed to the input end of the device. To reduce the number of distributor elements, the decimal system of counting is converted into the binary system with the aid of a special decoder. The telemetering system consists of a transmitter, receiver and remote control -- remote signaling device. Three experts of the Institute of Electronics, Automation and Telemechanics of the Academy of Sciences Georgian SSR in Tbilisi made the announcement ...

Nikolay Vasilyev, chairman of Mash-Pribor-Intorg, which is the USSR trading organization for computers and other instruments, stated recently that MPI's operations during eight months of 1960 were conducted with 60 countries involving over 1,000 foreign companies. He also commented that exports included modern devices for the automatic monitoring and control of industrial processes, applications of atomic energy and electronic computers.

CHINA

Professor Hua Lo-Keng, director of the Computer Center of Academia Sinica in Peking and also director of the Mathematics Research Center has written a full page article in the Kwangming Daily on the wide-scale application of operation research in China. The activity is taking place mainly in the Shantung province which is situated across the Yellow Sea from Korea. The article dealt particularly with the importance of applying linear programming to agriculture.

SWEDEN

The second data processing center using a Facit EDB Swedish-made computer and operated by the manufacturing company, has been opened in Gothenburg, Sweden. It is located at the Odhner office equipment plant in that city.

SWITZERLAND

A 709 computer will be installed on the site of the European Organization for Nuclear Research (CERN). It will be the largest of its kind in operation in continental Europe. Since 1958, CERN has had an electronic computer similar to those used in several European laboratories. The growing importance of electronic computing with the most up-to-date equipment in CERN's program will enable the organization to

form in this field one of its essential functions, namely that of fostering new scientific methods. To this end CERN will organize courses on modern computing methods.

ENGLAND

The English Electric Company is presently manufacturing the RCA 501 computer under license in the U.K., and certain of the equipment for this and other operations is purchased in the United States....A new digital computer, the Elliott 503, has a switching time of 5 milli-micro seconds. Elliot-Automation Ltd. is producing a complete computer system for the 503 which incorporates an unlimited extension of the storage facilities by means of new high speed magnetic tape storage units as well as a wide range of input and output equipment and special keyboards for the running of parallel programmes. A full range of automatic programming routines, including internationally agreed upon autocoding systems, will be available for the new computer.

The British Air Ministry has chosen an Associated Electrical Industries 1010 data processing system, valued at \$1,680,000, for controlling the distribution and issue of equipment and supplies to the Royal Air Force throughout the world. Demands for equipment and supplies from depots and units in the United Kingdom and overseas will be transmitted over telegraph circuits to the Supply Control Center near London.

U.S.S.R. - CHINA

A group of scientists from the joint nuclear institute at Dubna near Moscow have obtained for the first time heavy particles of xi-minus hyperons by using their proton synchrotron. Headed by China's Wang Kang-chang, the group of scientists included Mikhail Solovyev and Evgeniya Kladnitskaya of the Soviet Union, China's Ting Ta-chao, Korea's Kim hi in, Vietnam's Nguyen Din Ty and Rumania's Alexandr Mihul. They studied 102,000 photographs of traces of nuclear reactions and the results of the experiments were processed by means of an unspecified type of electronic computer.

POLAND

The Swierk Nuclear Research Center near Krakow in Poland has installed a British-made Solatron Space 30. It will assist in preparing plans for the installation of the second Polish nuclear reactor. The "30" is an analog computer with 30 amplifiers as offering flexibility in operation.

ENGLAND

The London Research Center of C-E-I-R Ltd. will be equipped with an IBM 7090 and IBM 1401. Dr. C. Oswald George, vice chairman of the British firm, said that the installation in London would be of immense benefit to business in Britain. While the center will introduce an increasing number of firms to computer experience, the largest users initially will be those who already have computer installations of their own.

JAPAN

Packard Bell Electronics has retained Kyokuto Boeki Kaisha, Ltd. of Tokyo as sales and engineering representatives in Japan for the distribution of computers, analog-digital converters, data handling components and digital systems produced by the company's computer division. The new reps have already secured orders for three 250 computers to be used by design and development groups in Japanese industry.

Nothing is lost in the translation with Benson-Lehner's new Machine Language Translator. What is gained, however, with this new solid-state instrument is the ability to translate machine languages. The Translator will automatically convert data in one digital code or form to, 1) output in another

digital code or form, or 2) to a signal suitable for input into any Benson-Lehner ElectropLOTter or similar device. Translation speeds are dictated by the input and/or output modes, i.e., operating speed in conversion of digital magnetic tape to graphs is limited by the speed of the graphing instrument. If yours is a problem in converting digital data to graphs or getting any format of recorded digital data to talk to any other format, let us know. We will make up one of these for you...fast. Write to: **benson-lehner** corporation, 1860 Franklin Street, Santa Monica, California.

1079.113 ÷ 600.116 × 9494 - 2.4 =

I was beginning to think you'd never ask!





new **DATAMATION** literature

BUILDING BLOCKS: Two new lines of high-speed logic modules are described in a six-page folder now available. Six of the circuits shown are in the 5000 series of digital test equipment, which feature graphic front panels and patch-cord logic. These include a transistor inverter, flip-flop, variable frequency clock, fixed frequency crystal clock, and pulse amplifier. The other seven units described are in the 6000 series of system building blocks, plug-in modules designed for high density packing in digital systems applications. Details on such accessory items as mounting panels, power supplies and high current pulse equipment are also given. **DIGITAL EQUIPMENT CORP.**, 146 Main St., Maynard, Mass. For copy:

CIRCLE 260 ON READER CARD

CODE CONVERTER: A new 8-page booklet highlights the features of a code converter, a new tape-operated communications machine recently developed. It is designed to integrate data processing when two different tape code systems are used by converting any 5-, 6-, 7-, or 8-channel system one to the other with a flick of a switch. The booklet describes the machine and shows it from several angles. **FRIDEN, INC.**, 1 Leighton Ave., Rochester 2, N.Y. For copy:

CIRCLE 261 ON READER CARD

DISPLAY BROCHURE: A 4-page, 2-color brochure describes Randid, a direct-reading, rapid-changing display that is designed for any program requiring rapid readout in alpha-numeric form. It is modular in construction, utilizing one printed wiring card for each display window. Each window has its own storage element. The unit can be packaged in either one or two modules. The display module contains the rotating tape, strobe lights and synchronization decoders. The brochure contains photographs and drawings. **HAZELTINE CORP.**, Electronics Division, Little Neck 62, N.Y. For copy:

CIRCLE 262 ON READER CARD

BUSINESS APPLICATION: An Illinois accounting firm is using a Bendix G-15 computer. The 4-page report outlines the program of A.S.C. Tabulating Corporation, which receives 1,000 bookkeeping entries from 30 clients by mail. Submitted to the G-15 system, the entries are processed and completed reports sent by return mail. Processing in 30 minutes what would usually re-

quire an account eight hours, the computer permits time savings. **BENDIX CORP.**, Bendix Computer Division, 5630 Arbor Vitae St., Los Angeles 45, Calif. For copy:

CIRCLE 263 ON READER CARD

MAGNETIC SHIELD: Data sheet 153 describes a multicellular magnetic shield. The unit consists of three individual enclosures having mating overlapping joints for each structure. Handles are incorporated to facilitate positioning and removal of the cover section. Each of the tri-section enclosures are separated from the others by a distance of approximately $\frac{3}{8}$ in. and are permanently positioned by filling the wall separations with epoxy resin. The data sheet includes a photograph and a brief bit of background. **PERFECTION MICA CO.**, Magnetic Shield Division, 1322 N. Elston Ave., Chicago 23, Ill. For copy:

CIRCLE 264 ON READER CARD

FACILITIES AND CAPABILITIES: A new 26-page booklet describes the facilities and capabilities of a large electronics firm. Divided into twelve sections, the publication covers the background, and gives a brief summary of the firms plants in various cities. Included in the booklet are sections on manufacturing, engineering, engineering support, systems, cathode ray tubes, direct and bright display, electronic printers, specialized products, special surveillance systems, plus over fifteen photos illustrating the topics. **STROMBERG-CARLSON**-San Diego, P.O. Box 2449, San Diego, Calif. For copy:

CIRCLE 265 ON READER CARD

DIGITAL MODULES: Catalog S describes series S plug-in modules. Designed to operate between dc and one megacycle, and within a temperature range of -20°C to $+55^{\circ}\text{C}$, the new series utilizes static circuitry and NAND logic. The catalog covers the entire S series. An explanation is given of the compatibility between the S series', one with the other, without the need for intermodular coupling networks or components, also the ability of the S series to drive the series T direct or through marriage circuits. **COMPUTER CONTROL CO.**, Western Division, 2251 Barry Ave., Los Angeles 64, Calif. For copy:

CIRCLE 266 ON READER CARD

PLUG-IN UNITS: A new 32-page booklet gives a detailed presentation of all 16 presently-available "A-to-Z" plug-

in units. The booklet includes complete specifications and performance characteristics—waveform patterns and other illustrations for various measurement applications. **TEKTRONIX, INC.**, P.O. Box 500, Beaverton, Oregon. For copy:

CIRCLE 267 ON READER CARD

SPHERICULAR FOLDER: A new 4-page booklet has been published on a new miniature incandescent readout, the SC-11. The publication includes complete mechanical and electrical specifications. **BURROUGHS CORP.**, Electronic Tube Division, Dept. LR-2, P.O. Box 1226, Plainfield, N.J. For copy:

CIRCLE 268 ON READER CARD

EQUILIBRIUM PROBLEMS: A 7-page report describes solutions to multi-components phase equilibrium problems with an analog computer. The problem discussed is a multi-component system in which equilibrium temperature, pressure, L/V ratio, and liquid and vapor compositions are calculated in either the liquid or vapor phase is specified. The computer's high speed repetitive operation with scope display provides almost instantaneous solution after problem set-up. The method disclosed is generalized and can be used for any number of components. **COMPUTER SYSTEMS, INC.** Culver Rd., Monmouth Junction, N.J. For copy:

CIRCLE 269 ON READER CARD

"DIAL-O-VERTER" SYSTEM: The "Dial-o-verter" system is completely described in a new brochure. The publication details the use of the system, which when used with the Bell System Data-Phone 200, permits use of regular telephone network, for sending and receiving data at high speed, to and from any number of remote locations. It describes the manner in which one can dial his telephone to transmit and receive data in machine language. **DIGITRONICS CORP.**, Albertson, L.I., N.Y. For copy:

CIRCLE 270 ON READER CARD

CATHODE RAY TUBES AND RECORDING STORAGE TUBES: A new brochure compares electro-mechanical characteristics of industrial cathode ray tubes and recording storage tubes. The brochure, entitled, "Display Devices," details 65 industrial cathode ray tube types and seven single and dual-gun, recording storage tube types. In a com-

plete and simplified chart, types offered by all manufacturers are listed in numerical order, indicating the physical and electrical characteristics, typical applications and operating conditions of each. RAYTHEON COMPANY, Industrial Components Division, 55 Chapel St., Newton 58, Mass. For copy:

CIRCLE 271 ON READER CARD

CONVERTER: A new 2-page, 2-color data sheet describes a frequency to analog converter, model 574, which is designed for advanced state of the instrumentation. This converter features 0.1% accuracy at up to 10KC, and variable and selectable time constant. Standard models have two channels; however, one channel models are also available. Model 574H is rated 10V output; model 574L is rated 1V output. The higher voltage is provided by a modular dc amplifier. These advanced design converters are designed to match the accuracy of instruments. POTTER AERONAUTICAL, P.O. Box 1123, Union, N.J. For copy:

CIRCLE 272 ON READER CARD

XY PLOTTING BOARDS: A new 5-page technical data sheet describes transistorized XY plotting boards, both single and dual arm, with electro-luminescent panels for backlighting. Detailed features and specifications are given for the 30 in. x 30 in. units which are designed for plotting data from digital and analog computers and for plotting tracking data from missile-range instrumentation systems. COMPUTER SYSTEMS, INC., Culver Rd., Monmouth Junction, N.J. For copy:

CIRCLE 273 ON READER CARD

TRANSISTOR SPECIFICATION SHEET: A specification sheet is now available on three series of PNP alloy junction transistors. Covering types 2N1118, 2N1118A and 2N1119, the sheet describes in detail the electrical and physical characteristics of these transistors and lists minimum and maximum ratings of the parameters. SPERRY RAND CORP., Sperry Semiconductor Division, Norwalk, Conn. For copy:

CIRCLE 274 ON READER CARD

TRANSMITTER-RECEIVER: A new 10-page booklet describes the dual tele-data tape transmitter-receiver now available. It is designed to transmit a single continuous tape at double the speed of a similar standard model. The booklet contains a full front view of the transmitter-receiver chassis and tone units, a similar half-tone with the tone unit cover removed, and a full rear view of the transmitter-receiver.

Transmission channel requirements for operation in either half or full duplex systems are also explained, as well as a description of the manual controls which simplify the duties for the operator of the equipment to a few basic procedures. FRIDEN, INC., 1 Leighton Ave., Rochester 2, N.Y. For copy:

CIRCLE 275 ON READER CARD

COMPUTER PAPER: "A Program of Automatic Differentiation for the BESM Computer," by L. M. Vega, Institute of Precision Mechanics and Calculating Techniques, Moscow, is now available. Send 50¢ to United States Department of Commerce, Washington 25, D.C.

DO NOT CIRCLE READER CARD

SILICON DIODES: Technical data and information on new "Sildisc" silicon diodes for printed circuit applications is now available. The various configurations, illustrated in the literature, make production assembly methods possible in terminal strips, plug-in, and clip-in mounting arrangements. The "Sildiscs" are also designed for standard subminiature light bulb sockets and are used for blocking in dc circuits. Separate literature is also available on the firm's diffused Zener diodes, double anode diodes, and gener-

al purpose diodes. CONTROLS COMPANY OF AMERICA, Electron Division, Tempe, Ariz. For copy:

CIRCLE 276 ON READER CARD

STATISTICAL DATA REDUCTION AND CONTROL SYSTEMS: A new 9-page publication, TM-1, "Statistical Data Reduction and Control Systems," discusses methods for increasing efficiency of data reduction and automation systems for quality control, continuous processing, and large scale experimental work. Need for statistical reduction of data prior to readout is stressed. MONITOR SYSTEMS, INC., Dept. 1, Fort Washington Industrial Park, Fort Washington, Penna. For copy:

CIRCLE 277 ON READER CARD

COMPUTER SERVICE: A new 12-page booklet describes a computer service for piping flexibility analysis. Using a simplified do-it-yourself input feature, the service provides an analysis within 24 hours, or less. A step-by-step report on the analysis of a three-anchor system and two two-anchor systems is outlined in the booklet. Photographs, diagrams and charts are provided. THE SERVICE BUREAU CORP., 425 Park Ave., New York 22, N.Y. For copy:

CIRCLE 278 ON READER CARD



CIRCUIT DESIGN

If this is your career interest, we have projects involving digital computers of extremely small size. Let us tell you more about this — confidentially. Write to Mr. Donald Krause — Research and Engineering Staff.

 LITTON SYSTEMS, INC. Guidance & Control Systems Div.
Beverly Hills, California

When responding, a mention of DATAMATION would be appreciated.

ADVERTISERS' INDEX

| | | |
|--|---|--|
| Anelex Corporation 28 | General Dynamics Corp., Electric Boat Div. 55 | National Cash Register 51 |
| Autonetics Division of North American Aviation 25 | General Electric, Computer Department 47 | Packard-Bell Computer Division cover 3 |
| Baird Atomic, Inc. 56 | General Electric, Heavy Military Electronics Division 24 | Philco Government & Industrial Group 4, cover 4 |
| Bendix Computer Division 21 | Graphic Systems 64 | Radio Corporation of America, Electronic Data Processing 52 |
| Benson Lehner Corp. 61 | Hermes Electronics Co. 50 | Radio Corporation of America, Industrial Electronic Products 27 |
| Computer Sciences Corp. 2 | IBM Data Processing 23, 30, 31 | Radio Corporation of America, Service Company 56 |
| Computime Sales Co. and Computer Services, Inc. 49 | Kearfott 26 | Ramo-Wooldridge, A Division of Thompson Ramo Wooldridge 34 |
| Control Data Corp. 18, 19, 33 | Litton Industries, Electronic Equipment Division 63 | Remington Rand Univac 54 |
| Datamatic Division Minneapolis-Honeywell 7 | Lockheed Missiles and Space Div. 29 | Space Technology Laboratories, Inc. 1 |
| Digital Equipment Corp. 53 | MAC Panel Co. 41 | Stromberg-Carlson-San Diego 58 |
| Electronic Engineering of California . 20 | The Marquardt Corporation, Astro Division 55 | System Development Corp. 57 |
| Friden, Inc. 22 | Telemetering Magnetics, Inc. cover 2 | TRW Computers Company of Thompson Ramo Wooldridge Inc. . 64 |

You Get Things Done Better By Seeing What's Happening

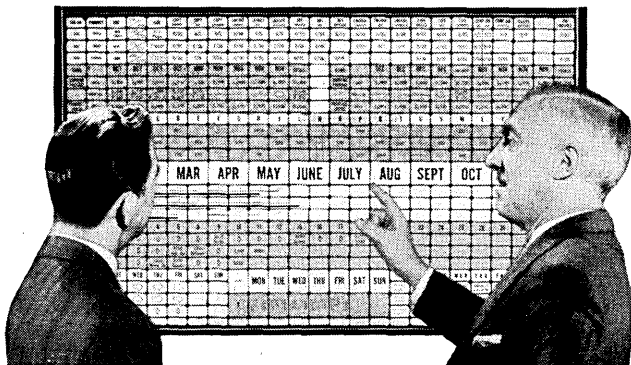

BOARDMASTER VISUAL CONTROL

- ★ Gives Graphic Picture of Your Operations in Color.
- ★ Facts at a Glance — Saves Time and Prevents Errors.
- ★ A Simple, Flexible Tool — Easily Adapted to Your Needs.
- ★ Easy to Use. Type or Write on Cards, Snap on Board.
- ★ Ideal for Production, Scheduling, Sales, Inventory, Etc.
- ★ Compact, Attractive. Made of Metal. 500,000 in Use.

Complete Price **\$49⁵⁰** Including Cards

FREE

24-Page ILLUSTRATED BOOKLET CG-40
Without Obligation

GRAPHIC SYSTEMS, Yanceyville, North Carolina
CIRCLE 25 ON READER CARD

COMPILER SPECIALISTS

TRW Computers Company needs two computer programmers who have the ability and interest to develop interpreters and compilers for a stored logic digital computer, as well as for conventional computers.

Nominal qualifications for the two positions are: degree in mathematics, science, or engineering; experience in programming a binary computer in machine language; plus participation for at least one year in the design and development of any existing compiler.

The stored logic concept of the computer offers an opportunity to the programmer to move ahead with the new state of the art. Contact:

Dr. Peter Friedlander
Programming Department Manager

TRW Computers Company

a division of *Thompson Ramo Wooldridge Inc.*



202 NORTH CANON DRIVE • BEVERLY HILLS, CALIFORNIA

CIRCLE 80 ON READER CARD

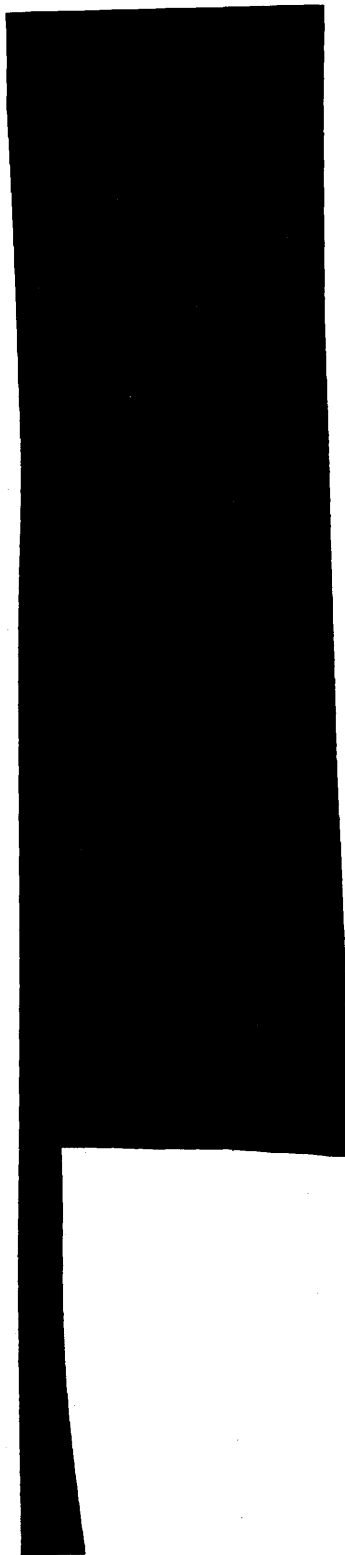
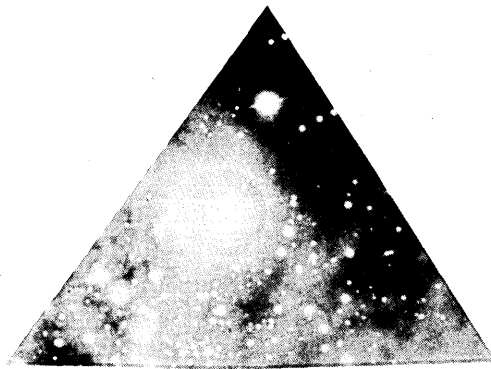

of operation with powerful capability...
...the computer...featuring: microsecond
speed...the CINCH interpreter...an
expandable memory...a full line of
peripheral equipment...systems or
scientific use...all at the lowest cost.

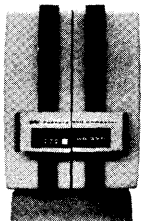

pb Packard Bell Computer
A Subsidiary of Packard Bell Electronics
1905 Armacost Avenue, Los Angeles 25, California
CIRCLE 2 ON READER CARD

World's fastest sorting system



PHILCO 2000 Data Processing System

■ The majority of all data processing involves sorting. Time saved on this operation is always significant—the answers you need become available more quickly; the equipment itself is freed for other use.

The inherent speed and capacity of the Philco 2000 are your assurance of highest possible sorting speed—faster than any other sorting system! For example, the Philco 2000 has sorted 100,000 80-character records, having a 16-character key, in 18 minutes!

Such high sorting speed can be obtained on any Philco 2000, regardless of size, without additional sub-systems.

Call or write to arrange a test run of one of your sort problems on the Philco 2000.

These Philco 2000 Features Assure Fast Sorting:

- A powerful SORT Generator Program—one of the many programming aids provided by Philco.
- High transfer rate on tapes—90,000 alphanumeric characters per second on each tape.
- Simultaneous reading and writing—with up to four tapes operating at the same time.
- Ability to read backward while writing forward—eliminating costly rewind time.
- Tremendous logical flexibility—plus eight or more index registers in an ultra high-speed system.

Philco Corporation • Government and Industrial Group
Computer Division, 3900 Welsh Road, Willow Grove, Pa.

PHILCO®

Famous for Quality the World Over

CIRCLE 3 ON READER CARD

MEMO •

This was accomplished with
the 10 microsecond memory. ←

With the new 2 microsecond
memory, we can do this job
IN LESS THAN 10 MINUTES!

