

August

9/16

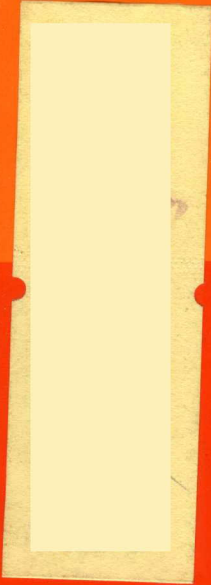

GEN. DEL.
GARRISONVILLE, VA. 22463

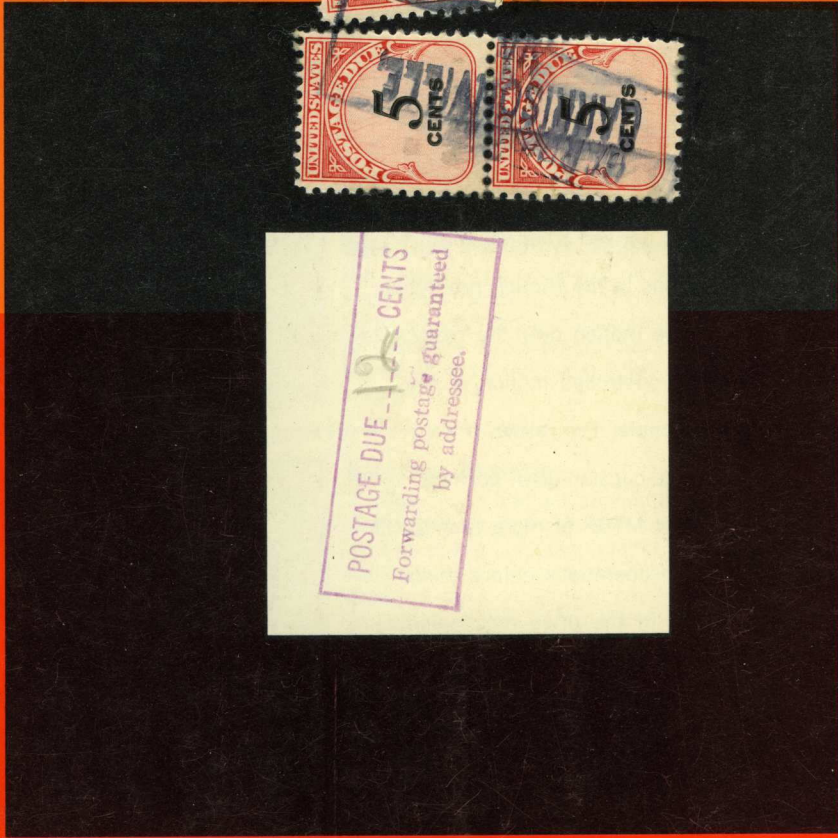

THE RAND SYMPOSIUM
defining the problem

Everybody talks about tape transport reliability.

When we say reliability we mean one billion stop/start operations without replacing a single part.

Reason? A simple (but revolutionary) single capstan drive concept that eliminates the rollers that pinch, the critical adjustments—all of the things that have previously made the transport the weak link in a computer system. Heart of the new concept is a single capstan drive and a low-friction tape path. The tape is held in contact with the capstan at all times by uniform tension derived from vacuum columns. Regardless of variations in the friction properties of the tape or mechanism, tape motion over the read/write head directly follows the servo-controlled motion of the capstan surface. The idea is simple. The results are extraordinary. The Ampex single-capstan-drive concept provides a previously-unheard-of MTBF of more than 2000 hours. It delivers 10^9 start/stop operations before minor replacement parts are needed in the drive mechanism.

In tests with data, 33 data blocks of 1024 bits (all "1's" in IBM format) were recorded at 800 bpi and re-read cyclically. *More than 160,000 passes of this one section of tape were made without a single bit error.* Everybody talks about "state-of-the-art" in tape transports. Ampex has delivered it. The new Ampex single-capstan transports are available in two configurations:

The high-speed TM-11 operates at electronically selectable speeds up to 120 ips, and densities of 200/556/800 bpi. The TM-11 meets all data formats. Plug-in 7 or 9 channel heads are available (ASCII compatible with IBM 360). Operator control panel and parity checking are optional. Militarized version available.

The medium-speed TM-7 is completely compatible with IBM tape formats and with other Ampex equipment. Packing density is 200, 556 and 800 bpi. Tape speed is electronically selectable up to 45 ips. Incremental and military versions currently under development. For complete specifications or demonstration, write Ampex Corp., Redwood City, California

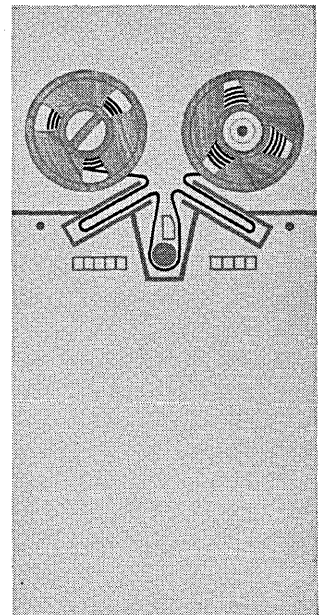
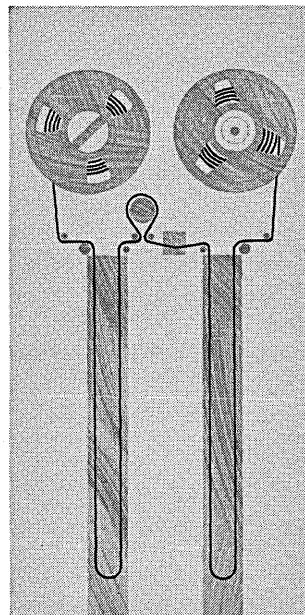

AMPEX

©AMPEX CORP. 1965

CIRCLE 1 ON READER CARD

AMBILOG 200 the only computer designed especially for signal processing

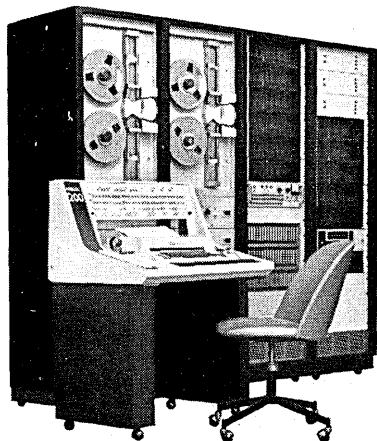

Using the best of both analog and digital techniques, the AMBILOG™ 200 Stored Program Signal Processor is designed from the ground up to handle the "floods of data" generated in test and research programs. Although such programs cover many fields — biomedical monitoring, geophysical research, test stand instrumentation, automatic weapons checkout, speech analysis — all require complex *signal processing*: multiple input acquisition and output distribution, monitoring, editing, arithmetic, analysis, recording and display. Because of its high processing speed and extensive input/output for both analog *and* digital data, AMBILOG 200 is ideally suited for such tasks. Here are some examples.

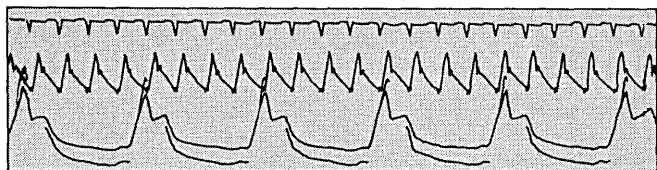

Real Time Waveform Measurement

Peak values, axis crossings, ratios of successive differences, and other characteristics of analog signals are measured in real time. Incoming signals are monitored for events of interest, using complex programmed detection criteria. In a typical biomedical application, the result is a 100-to-1 reduction in the bulk of magnetic tape output records.

$$A(n,w) = \int_0^T W(t)F(n,t) \cos(wt)dt$$
$$B(n,w) = \int_0^T W(t)F(n,t) \sin(wt)dt$$

Spectrum Analysis

Parallel hybrid multiplication and summing, 2 microsecond 30-bit digital storage, and a flexible instruction format providing efficient list processing combine to make the AMBILOG 200 powerful in statistical signal analysis techniques such as Fourier transformation auto and cross correlation, power spectrum density analysis, and generation of histograms of amplitude spectra.

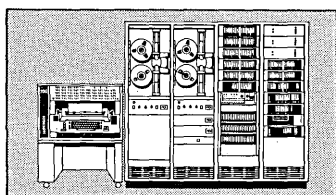

Digitizing and Recording

Multiple inputs, from up to several hundred sources, are routed through a multiplexer switch array under stored program control. At no penalty in sampling rates over conventional systems, the AMBILOG 200 converts incoming data to engineering units for recording or monitoring. An analog-to-digital converter performs a complete 15-bit conversion in 4 microseconds for digital storage, recording or outputting.

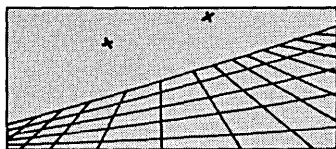

Display Generation

Multiple analog outputs facilitate close man-machine relationships in systems involving visual displays. Points of an image stored in memory are rotated through three space angles and projected on a CRT at a 50 Kc rate. Co-ordinate transformation is accomplished simultaneously with digital-to-analog conversion.

For technical reports describing in detail these and similar AMBILOG 200 applications, write I. R. Schwartz, Vice President.

Adage
INC
1079 Commonwealth Avenue, Boston,
Massachusetts 02215

Moore forms engineered to your machine

MOORE SPEEDIFLEX and Speediflo are narrow-carbon constructions assuring precise feeding on all types of printers and output equipment.

HIGH-SPEED PRINTERS get optimum output when Moore's continuous Speediflex, Speediflo, Fanfold or Tab Cards are used.

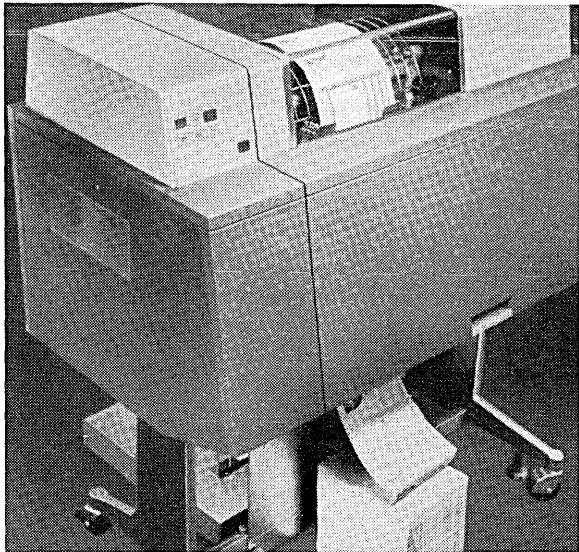

ALTERNATING FLEX CUTS in Speediflex position the form for perfect register. Ideal for high-speed printers and other writing equipment.

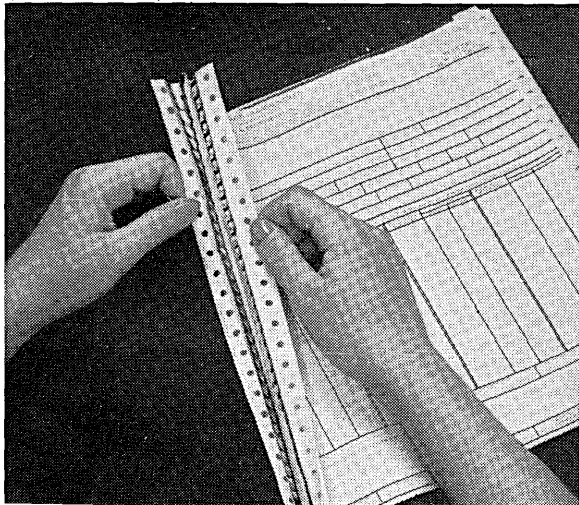

Whatever machine you use, for whatever use—your results are no better than your form.

The finest precision equipment—from a typewriter to the latest electronic reader—is no more effective than the paper it uses.

Because faulty forms cost far more than you pay for them initially, it is the best kind of insurance to use forms that help give you the lowest total cost of the overall operation.

This avoids dollar losses in...downtime delays, unreadable copies, idled men and machines, higher running costs and system failure.

Moore engineers your form to your machine. You are surer with Speediflex, Speediflo, Fanfold and Tab Card forms that promise efficient handling throughout.

You are surer with Moore's precision printing for perfect part-to-part register and legibility, its perfectionist manufacture, its high-grade paper, ink, and other ingredients.

Moore's construction know-how takes into account machine characteristics and differences—writing speeds, types of feed, manifolding requirements, refolding, etc. You get the form that is right for your equipment.

The Moore value you buy comes from overall Moore facilities—specially built presses; highly developed skills; carefully trained representatives; thorough system know-how; 32 modern plants producing almost unlimited constructions, with service before and after you buy.

If you work with forms, we can show you how to make forms work for you.



MOORE BUSINESS FORMS, INC.

"The right business form for every form of business" • Niagara Falls, New York • Park Ridge, Illinois • Denton, Texas • Emeryville, Calif. • Over 500 offices and factories in North America

BOOKKEEPING MACHINES using Moore Carbon-Ready Statements and Ledger Cards speed entries and assure legible entries.

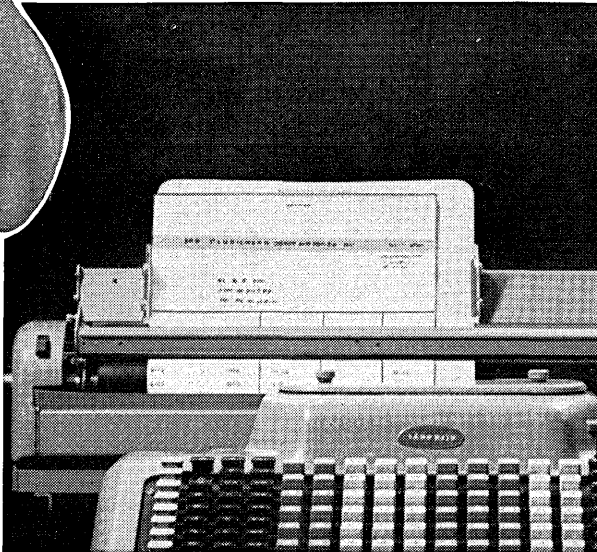

TYPEWRITERS with the Moore Formaliner attachment offer continuous production, using Moore narrow-carbon Speediflex, Speediflo or marginal punched Fanfold forms.

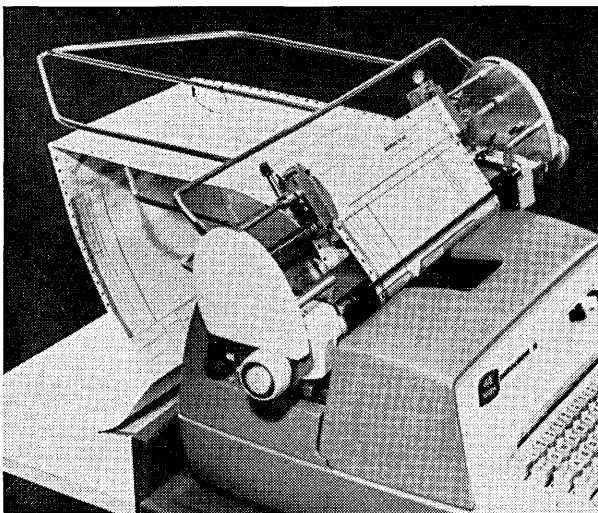

TELETYPEWRITERS using Moore forms achieve uninterrupted work flow because all Moore forms are a product of precision manufacture.

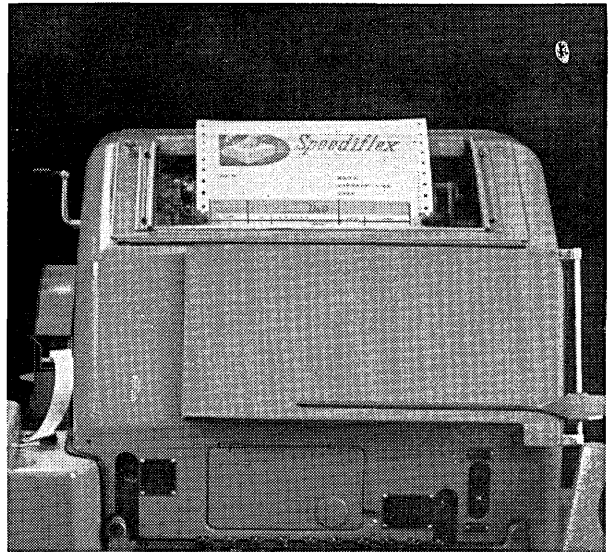

OPTICAL SCANNERS require precision forms to assure accurate reading of data and timing marks. Moore forms give optimum results on all scanners.

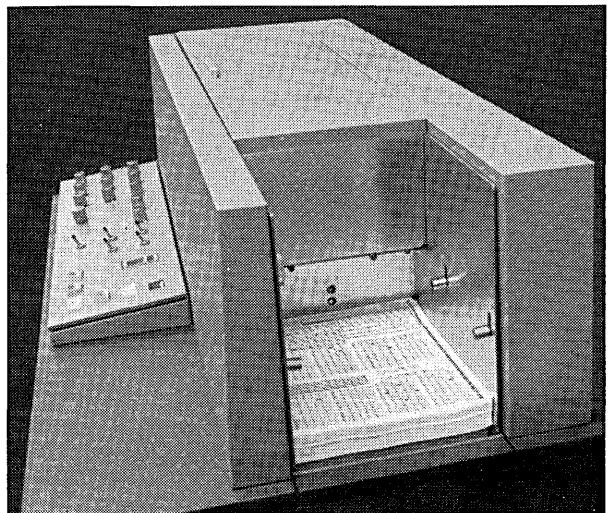

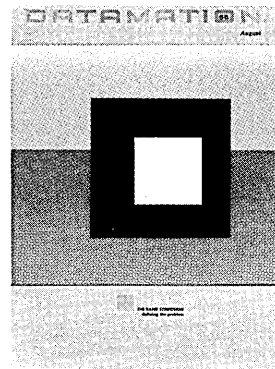

august
1965

volume 11 number 8

President
Publisher

FRANK D. THOMPSON
GARDNER F. LANDON

Editor
Managing Editor & Art Director
Associate Editors

ROBERT B. FOREST
CLEVE MARIE BOUTELL
EDWARD K. YASAKI
WILLIAM J. ROLPH
HEIDE E. HESS
ANGELINE PANTAGES
CHARLES WHITE
HOWARD BROMBERG
JAMES McCROHAN
ROBERT L. PATRICK
DANIEL D. McCracken
LOWELL AMDAHL
E. H. HERRON, JR.
MARILEE PITMAN
ALGENE TRAINA

Assistant Editor
Eastern Editor
European Editor
Contributing Editor
Washington Reporter
Editorial Adviser
Technical Consultants

Production Manager
Circulation Mgr.

Eastern District Managers

JAMES M. MORRIS
WARREN A. TIBBETTS
FELIX CHARNEY
141 E. 44th St., New York N.Y. 10017
[212] MURRAY HILL 7-5180

New England District Manager
& Vice President

WARREN A. TIBBETTS
112 West Haven Rd.,
Manchester, N.H., [603] NATIONAL 5-9498

Midwest District Manager

JOHN BRENNAN
205 West Wacker Drive, Chicago, Ill. 60606
[312] FINANCIAL 6-1026

Western District Manager
& Vice President

HAMILTON S. STYRON
1830 W. Olympic Blvd., Los Angeles, Cal., 90006
[213] 385-0474

EDITORIAL OFFICES
1830 WEST OLYMPIC BLVD.
LOS ANGELES, CALIF. 90006



Circulation audited by
Business Publications Audit



Member,
American Business Press, Inc.

Microfilm copies of DATAMATION may be obtained from University Microfilms, Inc., 313 No. First St., Ann Arbor, Michigan. DATAMATION is published monthly on or about the tenth day of every month by F. D. Thompson Publications, Inc., Frank D. Thompson, President, Executive, Circulation and Advertising offices, 141 East 44th Street, New York, New York 10017 (MURRAY HILL 7-5180). Editorial offices, 1830 W. Olympic Blvd., Los Angeles, California 90006. Published at Chicago, Ill. DATAMATION is circulated without charge by name and title to individuals who qualify by our standards and are employed by manufacturers or users of automatic information-handling equipment in all branches of business, industry, government and the military. Available to others by subscription at the rate of \$15.00 annually; single issues (when available) \$1.50. Annual rate for students: \$7.50. Foreign subscriptions are on a paid basis only at a rate of \$25.00 annually. No subscription agency is authorized by us to solicit or take orders for subscriptions. Controlled circulation paid at Columbus, O. Form 3579 to be sent to F. D. Thompson Publications, Inc., 205 W. Wacker Dr., Chicago, Ill. 60606. Copyright 1965, F. D. Thompson Publications, Inc.
Printed by Beslow Associates, Inc.

THIS ISSUE 58,702 COPIES

DATAMATION

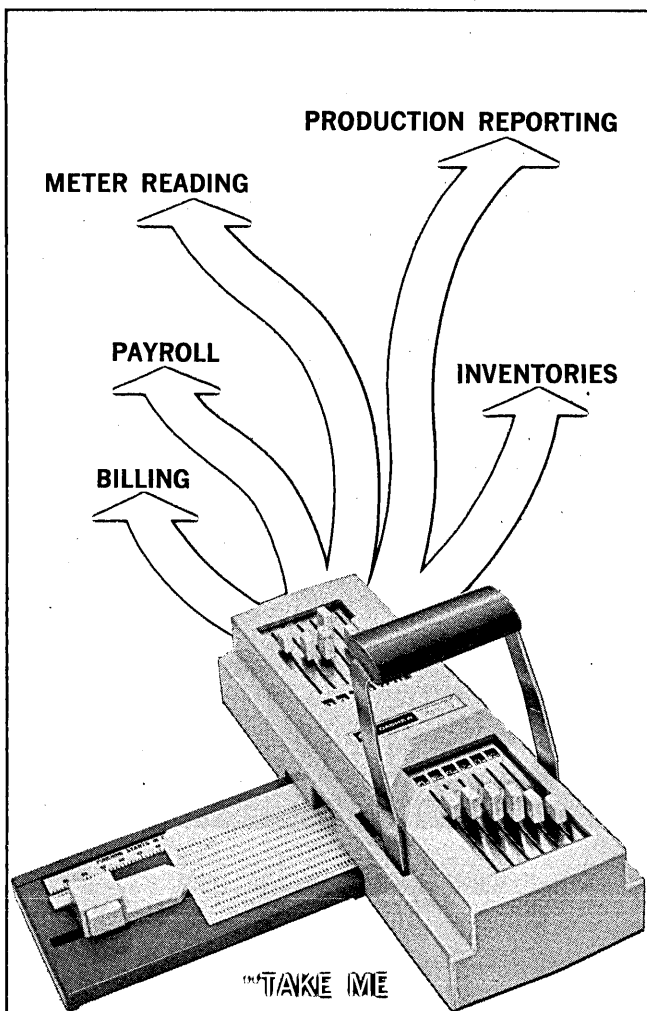

"TAKE ME
TO THE SOURCE
OF YOUR DATA"

PRINTAPUNCH®

UNIVERSITY MICROFILMS
SERIALS ACQUISITION

Light, portable, easily operated by non-specialists.

Punches and interprets up to 12 columns per hand-lever operation.

Pre-setting of punch fields via program bar.

Accommodates all columns of standard 51/80 column tab cards.

Why bother with data reconstruction in the machine room?
Put PRINTAPUNCH where the action is at the source.
Get back machine-readable data quickly and accurately.
Here at last is a practical, low-cost approach to source data
automation, featuring simultaneous 12 column operation,
readout window verification, interpreted printout "proof-
ing" and many other advantages. Get all the facts on
PRINTAPUNCH and decide for yourself! For full informa-
tion write for new descriptive brochure, or call



DASHAW BUSINESS MACHINES
1919 Vineburn Avenue • Los Angeles, California • 223-4111

CIRCLE 6 ON READER CARD

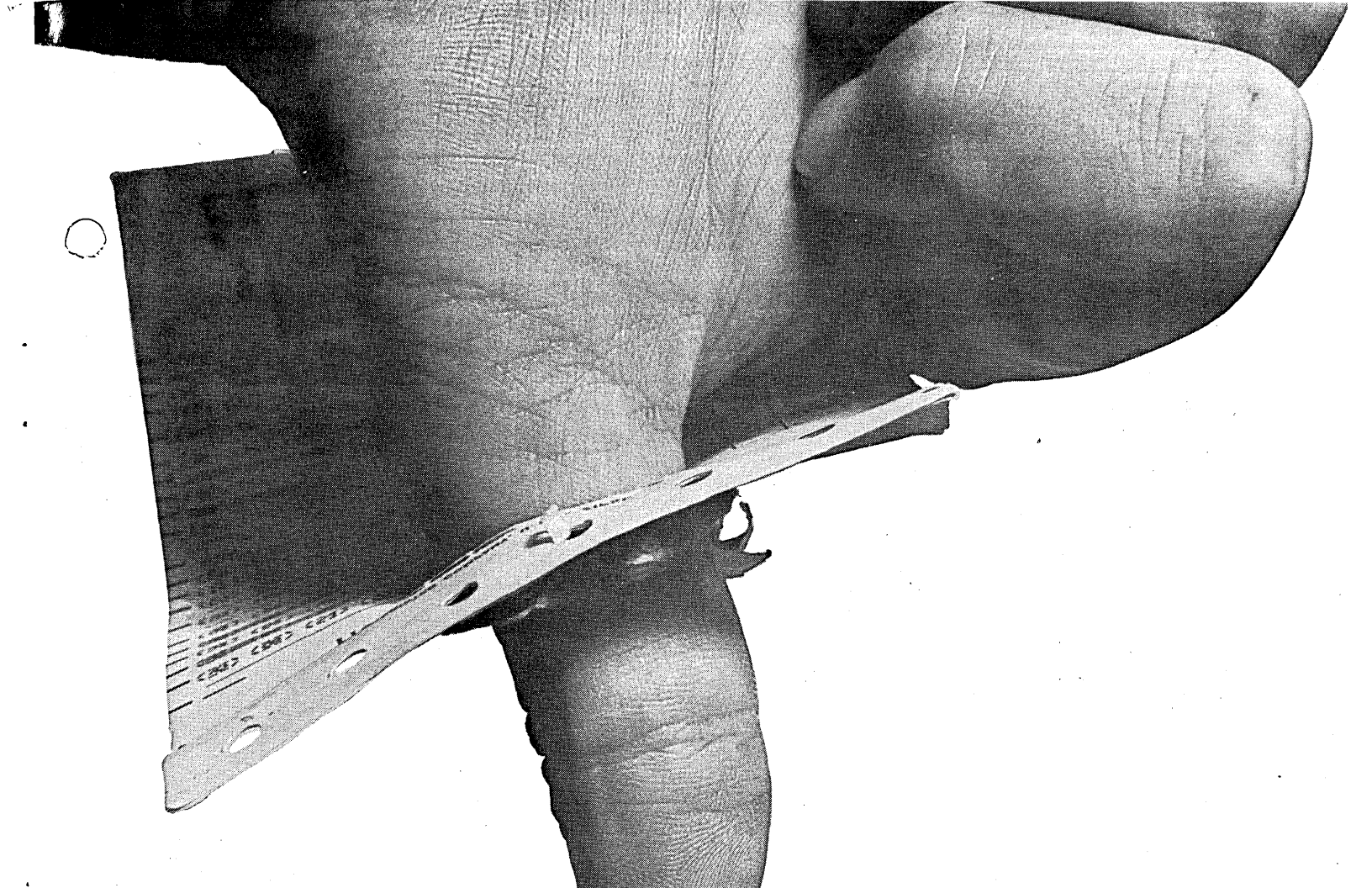

**John McNamara's thumb
is tougher on forms than
your high speed printer is.**

Any high speed printer is tough on forms. But not as tough as John McNamara's thumb. His job is to make sure our Machine Mated forms are made right. And if they fail to meet specifications?

It's thumbs down and throw them out.

The specifications are tough and precise. They're based on getting the most out of your printer.

We work with the people who make the printer. And with you.

So we can develop accurate, exacting standards for a whole range of forms to meet your needs. Standards for papers, sizes, plies, carbons, punching, alignment, copy, feeding, handling, and fastenings.

High standards and a tough taskmaster like John produce a better form.

And that means uninterrupted runs. With no downtime.

Why not see our representative? Or write us at

Standard Register, Dayton, Ohio 45401.

Now you know about McNamara's thumb. And where to put your finger on Machine Mated forms.

MACHINE MATED™ FORMS BY STANDARD REGISTER



CIRCLE 7 ON READER CARD

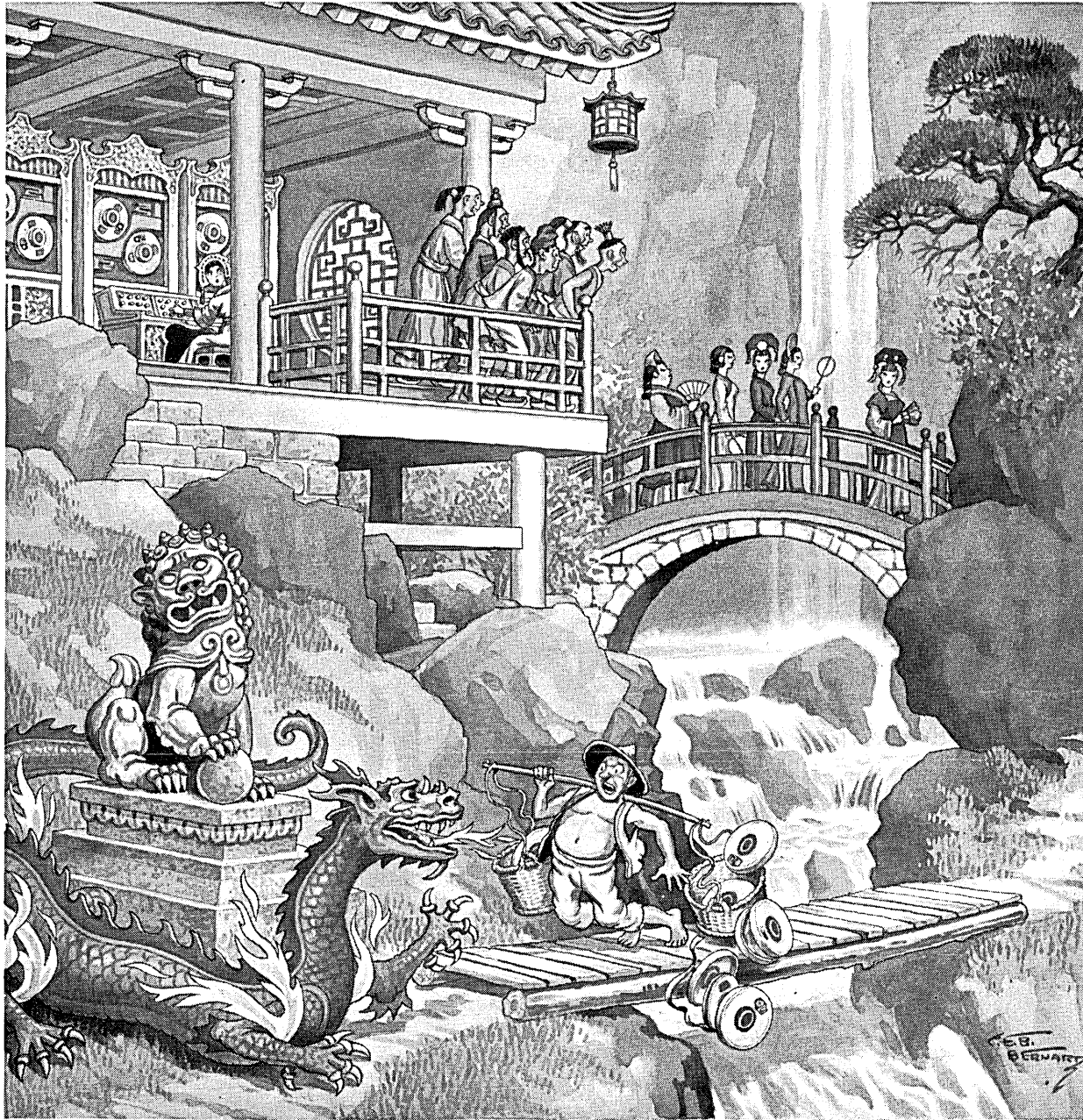

© Computron Inc. 1965

Once upon a time, there was an Emperor who kept 3,007 concubines to cheer his leisure hours.

In fact, there were so many Chinese cookies around, the Palace came popularly to be known as "The Bakery".

The Emperor was a fanatically suspicious man — so much so, he had a special bank of computers installed just to keep track of his harem. (Information as to the precise whereabouts of each of his charges was continuously fed onto reels of magnetic tape.)

Yet all his precautions did not prevent his very favorite morsel, Lotus Lovely, from running away, one moonless night, with the milkman.

*Reg. T.M. Computron Inc.

Pity the poor Emperor. He might have known that with ordinary magnetic tape you're bound to have a dropout problem. Which is why he switched to Computape.

One of a series of documentaries made possible by COMPUTRON INC., a company even more interested in making history than fracturing it. Our Computape is so carefully made that it delivers 556, 800 or 1,000 bits per inch — with no dropout. Available with 7, 8, 9, 10, 16 channel or full-width certification to meet your systems requirements.

Now — if Computape can write that kind of computer tape history — shouldn't you be using it?



COMPUTRON INC.

MEMBER OF THE **DASF** GROUP
122 CALVARY STREET, WALTHAM, MASSACHUSETTS

COMPUTAPE — product of the first company to manufacture magnetic tape for computers and instrumentation, exclusively.

CIRCLE 8 ON READER CARD

DATAMATION⁶⁵®

august
1965

volume 11 number 8

- 24 **THE RAND SYMPOSIUM.** *Part I covers discussions of amateurism vs. professionalism, what students and decision-makers should know about computing, and implications of time-sharing.*
- 31 **TELEPHONE SWITCHING BY COMPUTER,** by Dr. Erna S. Hoover. *Stored-program technique in phone switching facilitates addition of normal and special services for subscribers of Bell System.*
- 37 **CHOOSING A SET OF COMPUTERS,** by Alan C. Bromley. *Article describes studies that led to recommendation for next step in computers for a large corporation.*
- 41 **THE MARGINAL UTILITY OF INFORMATION,** by Donald V. Etz. *This economic concept is explained and applied to the present-day output of computers.*
- 44 **WESCON 65.** *Western electronics conference features some interesting computer-oriented sessions.*
- 45 **ACM NATIONAL CONFERENCE.** *Three-day meeting in Cleveland features almost 50 papers, seven panel sessions.*
- 48 **PESSIMUM PROGRAMMING,** by R. Thogonal. *Inept programmers, arise! We've found your leader.*
- 49 **THE B8500 FROM BURROUGHS,** by John T. Lynch. *Computer with thin film main memory and monolithic IC's has memory cycle times of 0.1 through 0.5 usec.*
- 51 **IN-HOUSE TAPE REHABILITATION,** by J. J. DeJianne. *A user reports on savings made by rehabilitating mag tape.*
- 58 **PROGRAMMERS & CHEAP COMPUTING,** by T. B. Steel Jr. *The effects of batch fabrication and advancing hardware technology may be a programmer's heaven.*

- 10 Calendar
13 Letters to the Editor
17 Datamation in Business & Science
21 Washington Report
23 The Editor's Readout
69 World Report
71 News Briefs
79 New Products
82 New Literature
88 People in Datamation
99 The Datamart
101 Books in Datamation
107 Advertisers' Index

automatic
information
processing
for business
industry & science

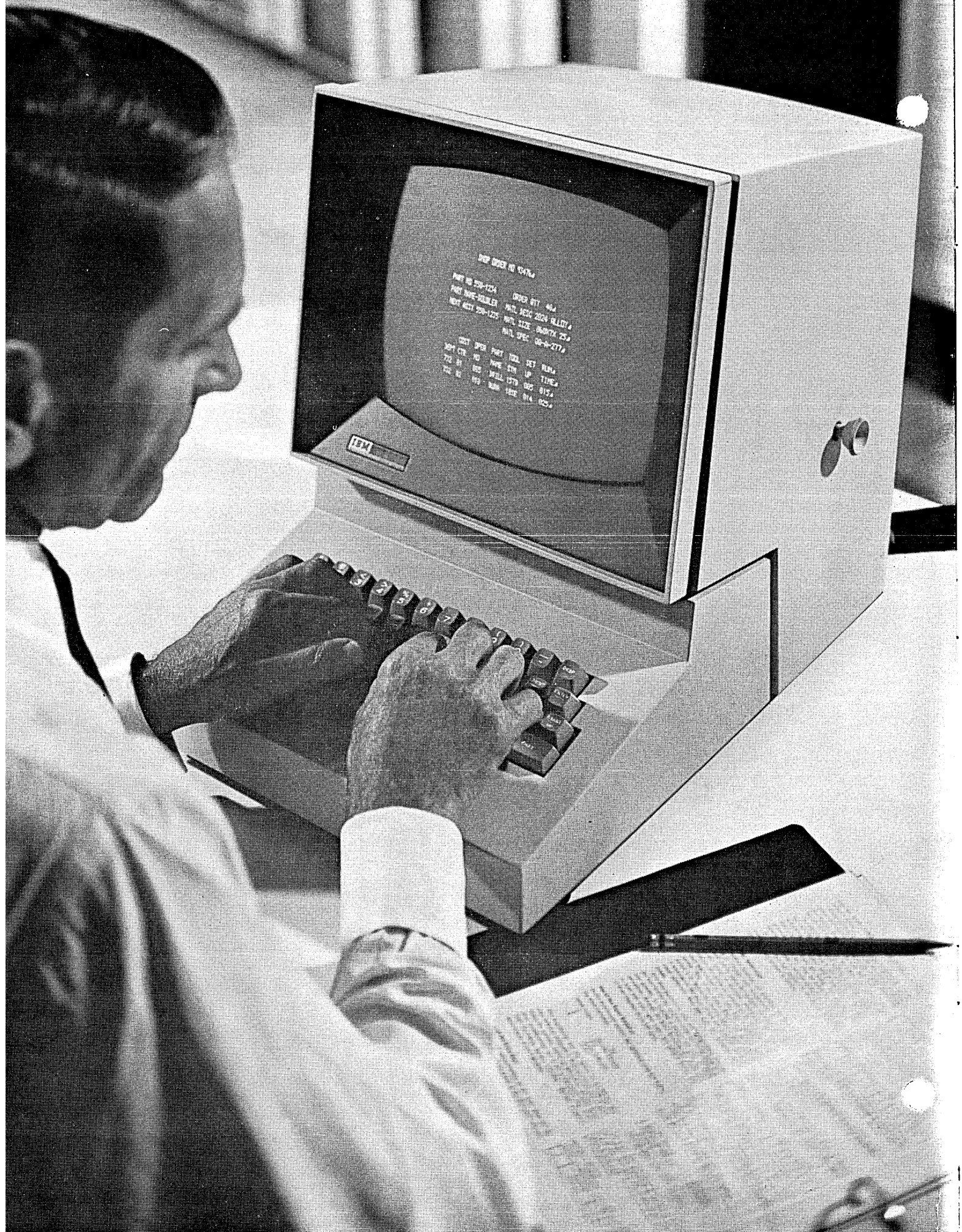

Get fast, low-cost access to your computer files.

With IBM's new 2260 Display Station.

Easier to use than a typewriter. Eliminates paper and filing cards. Fits on a desk top.

And it offers you access to almost unlimited storage capacity.

You can record daily sales activity and production reports. You can see your profit and loss statements at a glance.

You can also see the results of business and scientific calculations. Or customer lists, inventory data, insurance records and reservation lists.

You can plug *one*—or *one hundred* Display Stations into *one* SYSTEM/360 (Models 30 through 75). These Stations can be located in one building—or they can be thousands of miles away.

You simply "type" your information on a Display Station's numeric or alphanumeric keyboard. As you "type," your information appears as an image on the CRT screen.

You check the data. Or you edit it.

Then you press a control key and your data is fed into the central file of SYSTEM/360. Almost instantly, the screen displays your solution.

Or you can retrieve information from the computer. Update it. Change it. Then send it back into storage.

You can choose an IBM Display Station that has a 240...480...or 960 character buffer.

Each 2260 has 64 different display characters—both letters and

numbers. Twenty-three of these are special symbols. When directly connected to a computer channel, IBM's 2260 Display Station has a data rate of up to 2560 characters per second.

On a telephone line, its data rate is 120 or 240 characters per second—depending on the data set used.

The 2260 offers you fast access to all kinds of files. It's inexpensive: as low as \$89.00 a month.

Wherever you use typewriters, files, or paper—you can use an IBM 2260 Display Station. It will save you money...time...and space.

It's another new device to help your SYSTEM/360 grow as you grow.

SYSTEM/360—The Computer with a Future.

IBM®

CIRCLE 9 ON READER CARD

EVERYTHING

from a to d

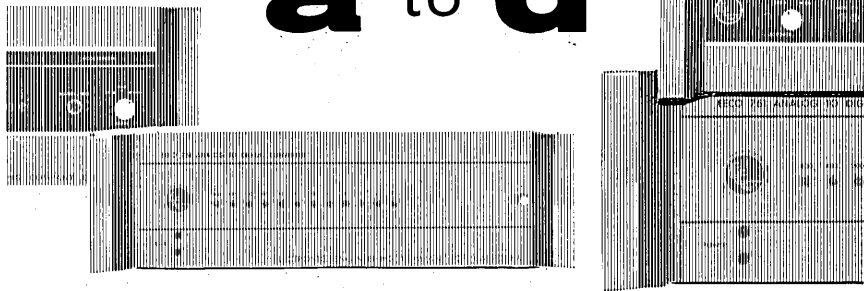

Now yours from EECO in 2 complete converter lines

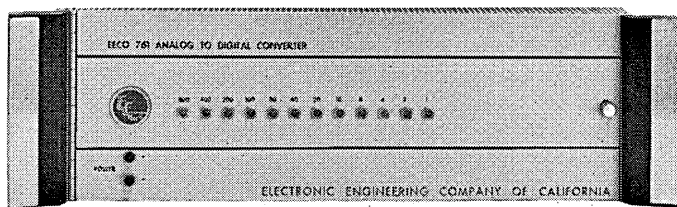

Series 761

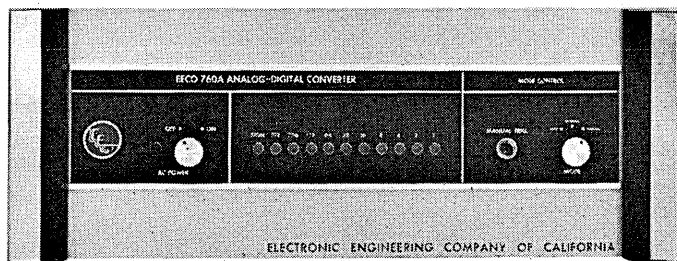

Series 760A

Take your pick—lower cost EECO 761 models with some quality features even high priced units don't have... or the greater speed, accuracy and sophistication of EECO 760A instruments.

Starting at \$1,800, EECO 761 models provide all solid-state construction... 15,000 to 25,000 conversions/sec... choice of output—binary (up to 11 bits) or BCD (to 3 decimal digits and sign), parallel or serial... automatic and external command modes... and much more.

For higher speed systems, select an EECO 760A model with greater resolution and speeds of 44,000 to 60,000/sec... increased accuracy.

The big news is versatility... with selection from literally hundreds of models. By changing circuit cards or adding modules, EECO can provide exactly what you want—within your price range. With either series you can get: sample and hold with 100 nanosec aperture... capability to measure low-level signals... input impedance to 100 megs... and a second output register for added buffering into your system. And, in 760A models, you can also have multiplexing or digital-to-analog conversion built right into the unit.

Want versatility and value in A-to-D converters? Look to EECO for a wide range of data handling equipment (multiplexers, converters, memories, buffers)... timing products... automatic programming equipment... test instrumentation... and complete timing and data systems.

See us at WESCON, Booth 3113-14



Electronic Engineering Company

of California

1601 East Chestnut Avenue • (Box 58) Santa Ana, California 92702
Phone: Kimberly 7-5501 Area Code 714 • TWX: 714-531-5711

CIRCLE 10 ON READER CARD

DATA MATION calendar

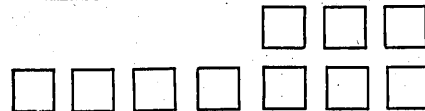

● Fall national symposium of the Society for Information Display will be held Sept. 29-30, Commodore Hotel, New York City.

● International Federation for Documentation will hold their meeting Oct. 10-15, in Washington, D.C. for documentalists, librarians and other information specialists.

● Users of Automatic Information Display Equipment will hold their annual meeting Oct. 11-14, Holiday Inn, New York City. Meeting will present latest advances in programs and techniques.

● Course in use of the MILITRAN simulation language, Oct. 11-15, Island Inn, Westbury, Long Island, N.Y. Sponsor is Systems Research Group Inc., Mineola, N.Y. Fee: \$200.

● Series of symbolic control seminars is being offered by IIT Research Institute, Chicago, Ill.—“Introduction to Symbolic Control,” Oct. 19, “N/C Management,” Nov. 2, and “APT Part Programming,” Nov. 15-19. Fees: \$35-200.

● Symposium on economics of edp is scheduled Oct. 19-22 in Rome, Italy. Sponsor is International Computation Centre.

● The H-800 Users Assn. will hold its fall conference at the Jung Hotel, New Orleans, La., Oct. 20-22.

● The national electronics conference will be held at Chicago's McCormick Place, Oct. 25-27.

● Computer workshop for civil engineers is scheduled for Oct. 25-27, Purdue Univ., Lafayette, Ind. Co-sponsor is American Society of Civil Engineering.

● Courses on “EDP Audit and Controls” will be held Oct. 25-29, Doric Dinkler Motor Hotel, Los Angeles. Courses are sponsored by the Automation Training Center, Phoenix, Ariz.

● Electronic Associates Inc. is offering the following courses: “Hybrid Computation,” Oct. 25-30, Princeton Computation Center; “Digital Computation,” Oct. 4-8, Los Angeles Computation Center, Nov. 29-Dec. 3, Princeton Comp Center; “Modern Methods in Analog Simulation,” Oct. 18-23, Princeton Center. Fees are from \$200-275.

etc. is a completely new kind of carbonless paper.

You can see some of its advantages demonstrated on the left.

Black, clear, smudgeless copies.

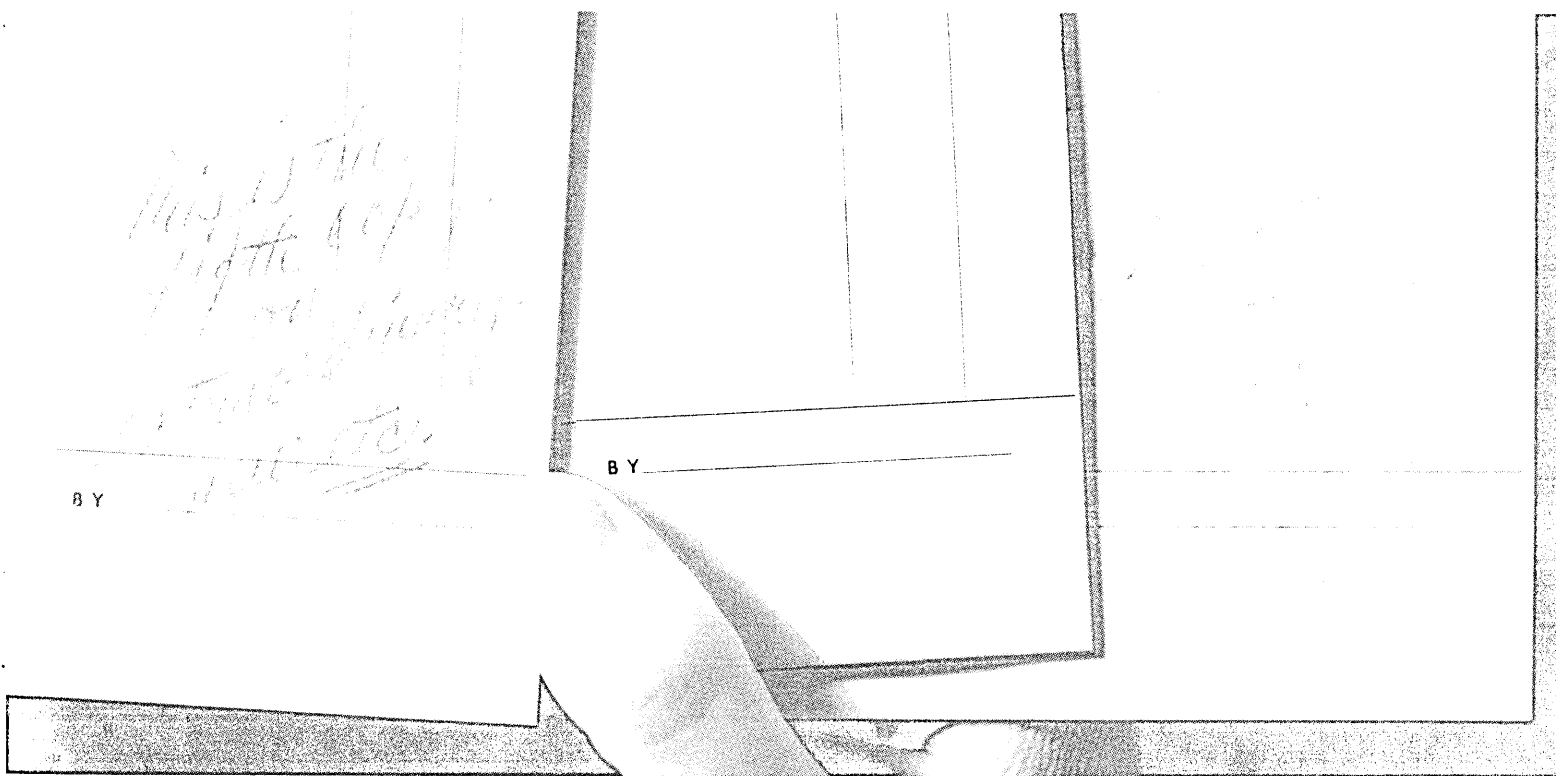

But there are 7 other advantages that may be even more important to you!

New Stan-Pak™ etc.® gives more copy power than any other multi-copy paper — carbon or carbonless. Up to twelve black, clear copies on an electric typewriter. At least seven with a ball-point pen. And ease in *handling* business forms printed on etc. adds up to real savings. In time and labor. Read why —then send for free sample kit.

1. Eliminates the carbon. Eliminates messy carbon handling and costly carbon waste.

2. Reproduces beautifully on office copying machines—because etc. copies are black and sharp.

3. Makes permanent images that never fade or distort. etc. copies are widely accepted as true facsimile legal copies.

4. Easy to handle as bond paper. In fact, etc. actually lies *flatter*. And it's sturdy 16 lb. stock.

5. More mileage from each print-out on a high-speed data printer. Stan-Pak etc. makes up to 9 black, sharp copies.

6. Stores indefinitely. You can buy at quantity prices with no fear that etc. will lose its freshness or ability to perform with age.

7. Pleasant to work with. Stan-Pak etc. is completely free of the annoying chemical odors so apparent with certain other papers.

All these advantages—and more—add up to the greatest improvement in multi-copy paper since the advent of carbon paper. Want proof? Clip the coupon.

Mills Division
Standard Packaging Corporation
Brewer, Maine 04412



eliminates the carbon

Please send free etc. sample kit.

NAME _____

TITLE _____

COMPANY NAME _____

ADDRESS _____

CITY _____

STATE _____

ZIP CODE _____

(Please attach to business letterhead)

8 steps to acquiring a better memory...

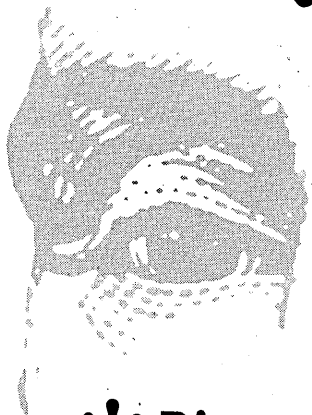
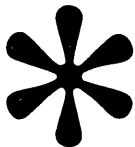

* Disc mass memory, that is.

For "time-sharing" and other applications where various computer systems must draw upon one large-capacity, central memory file designed for continuous and virtually instantaneous information processing, the Series L-4800 large-scale disc file produced by Librascope Group of General Precision, Inc., offers many remarkable new features. Consider the following before you buy or specify:

Step 1. Consider Capacity:

Where an extremely large amount of data must be stored, the memory element of an L-4800 large-scale disc file has an initial capacity of 400 million bits of information with expansion capability to 6.4 billion bits on a single trunk line.

Step 2. Inquire About Access and "Time Sharing":

The technique of information retrieval used by the random-access L-4800 is either fixed-address or record-content search, depending on the master-control electronics used. Average access time is 35 milliseconds. Search by record-content is an exclusive technique that permits any desired field to be used as the access key so that where the data is stored need not be known; only what information is needed. Costly flagging and table look-up are

eliminated and simultaneous off-line search is permitted. The L-4800 can be easily incorporated into time-sharing computer networks.

Step 3. Consider Flexibility:

L-4800 large-scale disc files can be used with any data processing system, whether already in use or scheduled to be installed in the future to provide faster, more accurate, more reliable operation with greater storage capacity.

Step 4. Inquire About High Transfer Rates:

The Series L-4800 disc files can be organized to transfer data at rates from 1 million up to 160 million bits per second. This is accomplished through multiple-head read/write operations. (The L-4800 discs have one head for every data track) Through adaptation of special electronics, data rates approaching 1 billion bits per second are possible for special applications.

Step 5. Ask About The Manufacturer's Experience:

Behind the L-4800 is the extensive background and 28-year history of Librascope Group of General Precision, Inc., in computer equipment and components.

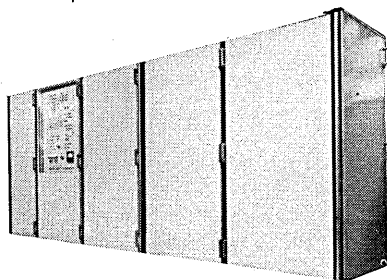

Step 6. Check The Equipment's Performance Record:

L-4800 disc files are a key part of a General Precision/Librascope data processing system in Headquarters USAF's 473L command-and-control system in the Air Force Command Post at the Pentagon. More than a million headbar hours have been logged without a single headbar failure. And, a scheduled installation for a scientific laboratory will provide a common data base for eight powerful computers, enabling many scientists and engineers to "share" the system on virtually a simultaneous basis. The L-4800, in this instance, will help replace magnetic-tape equipment twelve times more costly and which must now be manually monitored to provide the data base.

Step 7. Request Detailed Information:

Write today for our brochure showing applications, typical configurations, and complete specifications.

Step 8. Call or Write Us:

The quickest and surest way to acquire a better memory (an L-4800 large-scale disc file) is to contact our Marketing Department. The address is shown below.

SYSTEMS DIVISION

 GENERAL
PRECISION INC.

LIBRASCOPE GROUP

808 Western Ave Glendale 1, Calif.

Phone: (213) 245-8711

letters

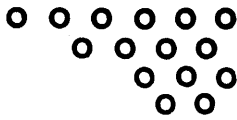

ibm vs. remrand vs. g.e.

Sir:

I have been following George Schussel's comparison of IBM and RemRand (May, June issues) with interest. The facts he bases his conclusions on comprise an impressive catalog of data processing history; therefore I was amazed by the inaccuracy of the "facts" he cites for the Univac installation at General Electric in Louisville.

Four comments he makes on pages 65 and 66 leap up off the page for anyone who was involved in that project. Schussel says:

- Even when the computer was run 24 hours a day there was not time enough to get out the payroll;
- The first group that worked on the project at GE was fired;
- By the time the installation was working, late in 1956 . . . , and
- The programmers of the Univac stored this entire table on tape (the withholding tax tables).

These four statements are absolutely incorrect and have no basis in fact.

As a member of that original group, and a current GE employee, I must say the news of my discharge comes as a surprise. It set me to taking stock of my colleagues who, as graduates of the first programming class back in August 1953, formed the first project team. Of the 10, eight are still employed by GE and all eight have risen into managerial ranks. The two who left did so voluntarily.

The installation must be counted as "working" at the beginning of 1955, for two major systems were in operation at that time. In fact the first pay date was October 19, 1954 and in the 500-plus pay cycles since October 1954, that installation has not been late on a payroll.

The business about a table look-up for tax deductions is quite mystifying. Tax is calculated by the program that calculates all pay calculations, PR340, and neither its predecessors PR140, PR95 nor its derivatives MP340 or WP340 have ever used a table on tape or in memory for tax.

The longevity record of the original crew is equalled by the two systems they designed: payroll and material control. Both systems, reprogrammed

many times, are in use today. I/O routines, packaged sorts, compilers and such came later and have found use without altering the basic concepts. The original file design and system organization survive with little change.

It is unfortunate that with eye-witnesses available, the author drew on other sources; I hope this information will assist those who follow him.

No, I am not cancelling my subscription; with 60K circulation you wouldn't miss me, but I sure would miss DATAMATION because with all its aberrations, it's still the greatest.

JOHN K. SWEARINGEN
General Electric Company
San Jose, California

P.S. As past-president of the DPMA, thanks for the generous and informative coverage of DPMA's June conference. I'm sure your treatment helped swell the record crowd of 2,700 registrants for the seminars and additional thousands who crowded around some \$30-million worth of hardware in the exhibit hall.

Sir:

Part II of "IBM vs. Remrand" (June p. 58) proved to be as interesting as Part I. Congratulations on a well-done article. I believe, however, the pictures on pages 61 and 66 are reversed.

O. W. PERRY
Fishkill, New York

Sir:

The photo on page 66 is the console of the IBM 701 at World Headquarters in New York. On page 61 is the card feed station of the SSEC.

ERIC U. WEISS

conferences a no-go

Sir:

I have been attending computer conferences for approximately 15 years, and over this time have watched them develop and change. I would like to suggest that our industry has now reached the stage of maturity that makes two general conferences each year unnecessary and wasteful. It has

RELIABILITY

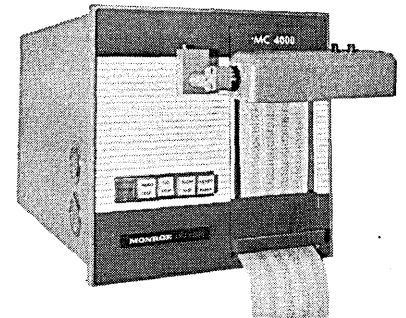

Ultra high speed
Monroe DATA/LOG®
MC 4000 Printer
delivers

**6000 lines
per minute!**

That's 100 lines per second, synchronous or any speed less than 100 lines per second that your application might require. The MC 4000 is truly synchronous or asynchronous.

A non-impact printer. Completely silent. Absolute reliability.

It's available in a numeric model (15 characters in each column) or in an alphanumeric model (43 to 64 characters in each column). Both models are 32 columns wide and have the same 6000 lines per minute printing speed.

Look at these MC 4000 features: Character serial input, bit parallel. Data transfer time of 50 microseconds (no buffers required). Only two moving parts—the paper feed stepping motor and the fan. Compact: 10½" high, 10¾" wide. Rack mount available. All solid state with cathode ray tube through fiber optics.

Any 4 line code for the numeric model; any 6 line code for the alphanumeric model. Any logic level.

Price, just \$5650 for the numeric, \$5850 for the alphanumeric model.

Reliable. Silent. Ultra high speed Synchronous or asynchronous.

And, like all Monroe DATA/LOG printers, the MC 4000 is covered by a full year's warranty with on-site maintenance.

For additional information, specification sheets or a demonstration, write or call Monroe DATA/LOG Division of Litton Industries, 343 Sansome, San Francisco. (415) 397-2813.

**MONROE
DATA/LOG** 
DIVISION OF LITTON INDUSTRIES

handsome is..... handsome does

Sharpening old axioms is not our business. It's just that designers of EDP systems speak axiomatically when they tell us the new **D 3030** computer magnetic tape unit delivers a triple load of beauty: unprecedented **reliability, economy and operating convenience**. In addition to which, they say, it's so nice to look at!

Already the famous Datamec **D 2020** has set industry standards for low-cost operation in computer and off-line applications where moderate speed performance is highly practical (data transfer rates up to 36,000 cps). Now the new **D 3030** offers the same superior advantages for heavy duty, on-line use with digital computers and other digital EDP systems requiring higher data transfer rates.

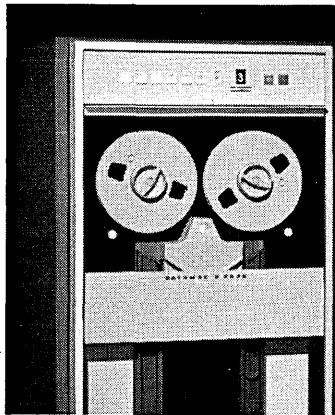

The **D 3030** writes and reads all three densities (800, 556 and 200 cpi) at 75 ips tape speed. Push-button selection of 60,000, 41,700 and 15,000 cps data transfer rates. Either 7-track or 9-track format. Vacuum column tape buffers, semi-automatic tape threading, front access to all electronics, and many other advanced features. Bi-directional start and stop times of 5 ms and 1½ ms, respectively.

For all the facts, including pleasantly surprising low price quotations, write Tom Tracy at Datamec, 345 Middlefield Road, Mountain View, Calif.

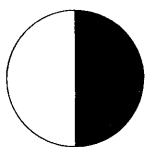

DATAMEC
A DIVISION OF HEWLETT-PACKARD
leadership in low-cost/high reliability
digital magnetic tape handling

CIRCLE 14 ON READER CARD

LETTERS . . .

become increasingly evident that there is insufficient material of a high professional standard to warrant exposure at two annual meetings. I doubt, in fact, if there is enough for a single meeting. This is not criticism of the standard of professionalism within the industry; it is, rather, a reflection of the growing maturity and the slowing rate of technological change and innovation. With respect to the exhibits, the rate of change is even slower.

It seems to me that the main groups to be kept in mind when organizing conferences are the younger and middle professionals. Conferences serve to introduce these people to various aspects of our profession that they do not normally experience. Unless the caliber and the interest of conferences is carefully guarded, the impression created for these new people is not one of high interest and excitement, but rather of boredom. Since in a very real sense our industry is the most vital in our time, this impression is a real disservice to these people.

I appreciate that conferences are very profitable for AFIPS and tend to be a principal source of revenue, but as responsible professionals this easy advantage should not be used as a justification for continuing meetings which have, I believe, deleterious effects on the most important segment of the computing society.

MAX PALEVSKY
Santa Monica, California

wilson's law

Sir:

From an observation of resumes and applications over the past few years, I have been struck by an unaccountable trend which the present vogue for "laws" forces me to formulate as follows:

"The number of people actively engaged in data processing in 1955 doubles every three years."

WILLIAM J. WILSON
Huntsville, Alabama

planned obsolescence

Sir:

I'd like to suggest that computer people observe October 17 (Rube Goldberg's wedding anniversary)* as a holiday in honor of the 029 keypunch.

This machine is the first improvement in keypunches since 1949, and

* His birthday would have been preferable but, alas, it's July 4.

represents the accumulation of ideas since that time. As a preliminary announcement put it, "Engineers gave a lot of thought to a key person in data-processing installations, the operator of the equipment." These key persons are typically young ladies, and doubtless the engineers gave them lots of thought. It's unfortunate that they didn't give more thought to the design of the machine. Their only real constraint, apparently, was to use as much as possible of the punching, feeding, and printing mechanism of the 026, onto which they superimposed their improvements. It's an impressive list:

1. A plastic cover has been placed over the entire card bed, so that access to the backspace key or to either position of manual feed takes two hands. A special polish on this cover permits the maximum amount of overhead light to shine at the operator.

2. The column indicator, which used to be difficult to read, is now nearly impossible to read from the normal sitting position.

3. The hopper stop switch no longer shuts off the entire machine, but merely suspends feeding. This is an improvement. To compensate, the machine's power switch is now mounted under the work board.

4. The correction key (probably the most valuable single feature available on the 026) is missing, and there seems to be no provision to add it to the keyboard.

5. The 4-5-6 home keys, which used to be concave so that while touch punching the operator would know when she's home, are now the same as the other keys.

6. Gone is the joggle plate.

7. The base of the machine, which used to slant back away from the operator, now comes straight down, and is equipped with a nylon-tearing edge to endear it to young ladies.

8. The keyboard has been human engineered to the extent, for example, that the "less than" and "greater than" symbols (part of the 64-character set) are on opposite shifts.

9. The space bar stands higher than the other keys, making it simpler to hit at the wrong time.

It was Rev. Granholm who first defined a kluge as "an ill-assorted collection of poorly-matching parts, forming a distressing whole" (*DATA-MATION*, February 1962). But he was referring to an original design, not to 16 years of accumulated improvements.

AUSTIN O. ARTHUR
Woodland Hills, California



*When this headline was current news...
digital recording tapes
had a packing rate of 200 bpi.*

*Today, 800 bpi is standard;
improvement in tape and base is the reason.*

In analyzing the sensational development of EDP over the past decade, most of us naturally talk in terms of improvement of hardware. But when you stop to examine them, the contributions made by tape manufacturers have been quite remarkable.

The tape of today looks like the tape of 1954 . . . but think of the differences: improved oxide coatings to increase total capacity, reduce fluctuations in performance; much stronger binders to reduce dropouts and flaking, lengthen tape life; smoother surfaces to give longer, error-free wear; thinner coatings and better production controls to guarantee reel-to-reel uniformity.

Working hand in hand with the tape manufacturers during this time has been Du Pont. Improvements in the uniformity, stability and overall reliability of the base of MYLAR* have played a vital role in making possible the sophisticated tape in use today. Continuing cooperation of research and development facilities assures continuing improvements in the future. Your guarantee of the most advanced tape is the manufacturer's brand and a base of MYLAR polyester film.

*Du Pont's registered trademark for its polyester film.



Better Things for Better Living...through Chemistry

At the base of all tape improvements: Mylar®

CIRCLE 15 ON READER CARD

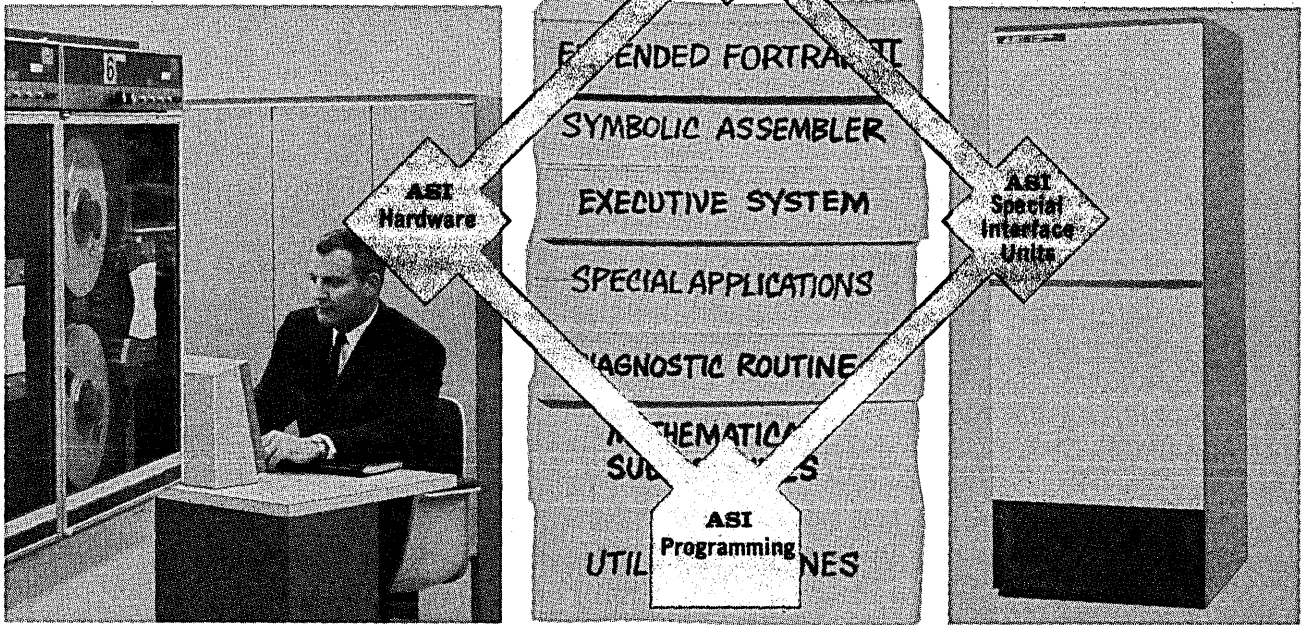
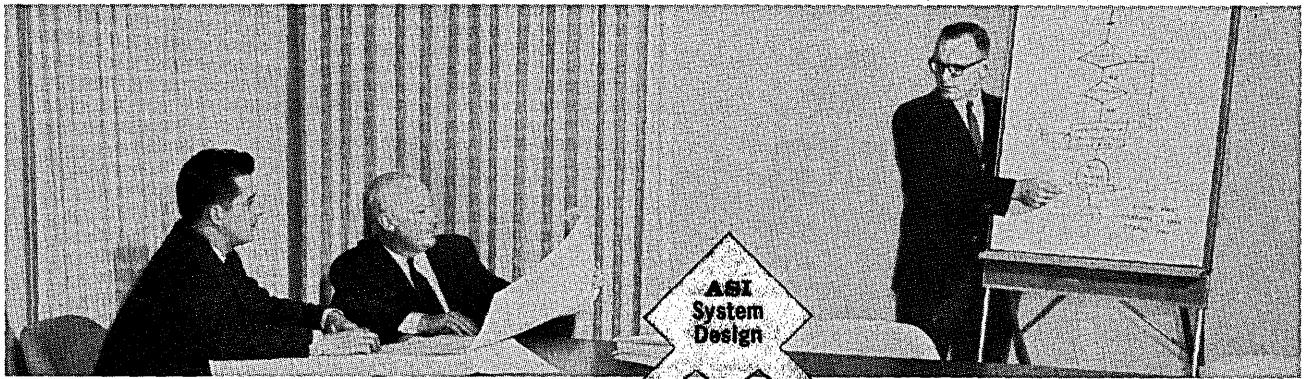

From ASI's continuing program of new product development

ASI data systems experience covers all bases

In selecting a computer supplier for your integrated system, hardware is not the only criteria—systems design, special programming, and unit interfacing must be considered. ASI offers all of these with a notable plus—total customer service. From the time you define your problem, through design, interfacing, installation, and operation, ASI system specialists provide thorough, detailed support at NO ADDED COST.

Review the following major areas where ASI will benefit your system design.

SYSTEMS DESIGN—At no cost, ASI system specialists will completely analyse your required system in the definition phase before purchase. At this time ASI can tell you precisely what the system characteristics will be. Experience in the areas of data reduction, hybrid, real-time, and on-line systems design assure a balanced, efficient system.

STANDARD HARDWARE—The ADVANCE Series 6020 and 6040 computer systems feature high internal processing speeds such as 3.8 usec add and 9.5 usec multiply, rapid in/out rates, and a multilevel priority interrupt arrangement, which improve system application and operation. Other

system-oriented features include—a choice of communication channels to meet your exact needs—expandable memory—over 8,000 control and sense lines—three index registers—"Programmed instruction" feature—direct access to memory areas—and real time clock.

SPECIAL UNITS—ASI Engineering, at modest cost, will design and provide special interface units. In addition to typical units such as A-to-D and D-to-A converters, multiplexers, etc., ASI also has provided "black boxes" for such applications as multi-channel analysers, remote station operation, photo-optical systems and others.

PROGRAMMING—To complement the standard software, which includes a one-pass extended FORTRAN II compiler and one-pass symbolic assembler, ASI applications staff provides special program preparation assistance. When requested, ASI will contract for total program responsibility on any ADVANCE Series computer system. Local field applications analysts are also available to aid in the daily operating routine as well as installation and operation of new programs. Call on ASI—it will be good for your system!

ASI

ADVANCED SCIENTIFIC INSTRUMENTS

DIVISION OF ELECTRO-MECHANICAL RESEARCH, INC.

8001 Bloomington Freeway, Minneapolis, Minnesota 55420

DATAMATION

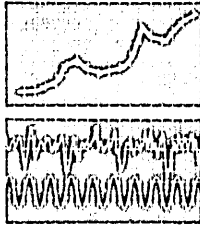

BUSINESS & SCIENCE

NEW POST, NEW HOPE FOR GOVERNMENT EDP

A new federal computer post, to be manned by an old edp pro, offers hope for progress in standards and more intelligent use of government machines. Rumors are rife that the new position, Director of the Computer Science & Technology Center in the Bureau of Standards, will be filled come Oct. 1. by Norman J. Ream. Director of Systems Planning at Lockheed Aircraft Corp. for the past 13 years, Ream -- if he accepts -- can bring to the post beaucoup industry contacts, a reputation as a good organizer and go-getter. His broad private industry background could soften fears of Big Brother dictation of arbitrary standards. But he could also be expected to pressure manufacturers to conform to standards and cooperate in the development of industry-developed standards rather than one-company *de facto* standards.

The position is a step towards meeting the specs for more centralized control and guidance of gov't edp activities, as outlined in BuBudget's Circular A-71 (see April, p. 70). Still due: a similar spot in GSA. But the budget available to the expanded NBS effort is still in doubt. A House appropriations committee has cut back fund requests, will now discuss with Senate dollar watchers. One possible partial remedy: the use of industry-sponsored research associates, for which NBS precedence already exists.

FOOLS WITH ANGELS RUSH IN

Although only IBM and a couple of others are making money at computers, new hopefuls keep appearing. Up in Sunnyvale, Information Technology, Inc. has a \$250-thou backlog for its 4900 (see April New Products), has sold 12 to Wright-Patterson. At China Lake, the 4900 beat out the GFI Marc I, CDC 46, PDS 1020, PB 250, PDP-8 and a machine from Ann Arbor Computer Corp.

The last-named company is a spin-off of Strand Engineering, which was purchased and converted into the Burroughs Ann Arbor Lab. Acting as a system house, AACC bids on jobs using other manufacturers' main frames, now has seven full-time employees, plus consultants ... hopes to do \$1 million next year.

Meanwhile, down in Dallas, about 30 people coughed up some \$300K to launch Scientific Control Systems. Headed by key people from International Data Systems and TI, SCS is offering initially two versions each of two 24-bit main frames which include SDS 910 & 920 commands as subsets of their instruction sets. The 660-2 (using software for multiply and divide) with 4K of 2-usec-cycle core, sells for \$56K as compared to \$52.5K for a 4K, 8-usec 910. The 660-5 with 4K of 5-usec core, costs \$46K vs. \$57.5K for a 4K, 8-usec 920. The company, which also makes telemetry and signal conditioning gear, will also offer a 12-bit, 10-usec core 650, and a hybrid circuit 680

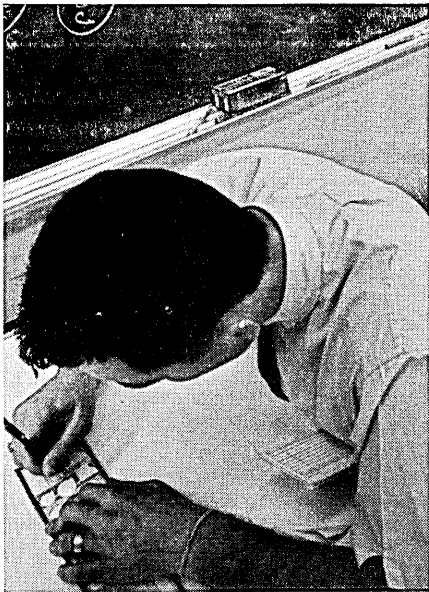
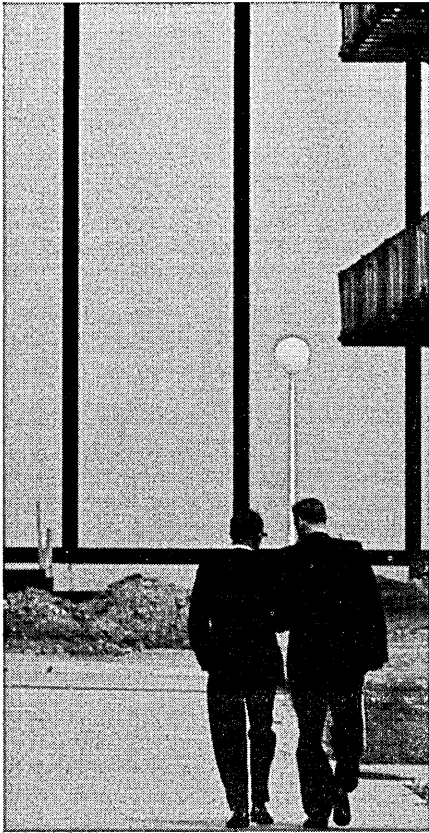

F
Texas, represent both a challenge and a persons everywhere. Wolf Research and undertaking. Would you like to join us? We been solving advanced problems using all ants, we seek only answers. Our reputation — Our future anticipated requirements are analysis and evaluation of information vital in College Park, Md., also has a number of ce with large-scale computers and a BS or

Box 1036, Baker Avenue, West Concord, Mass. 01781

A
New
Generation
Has
Been
Born

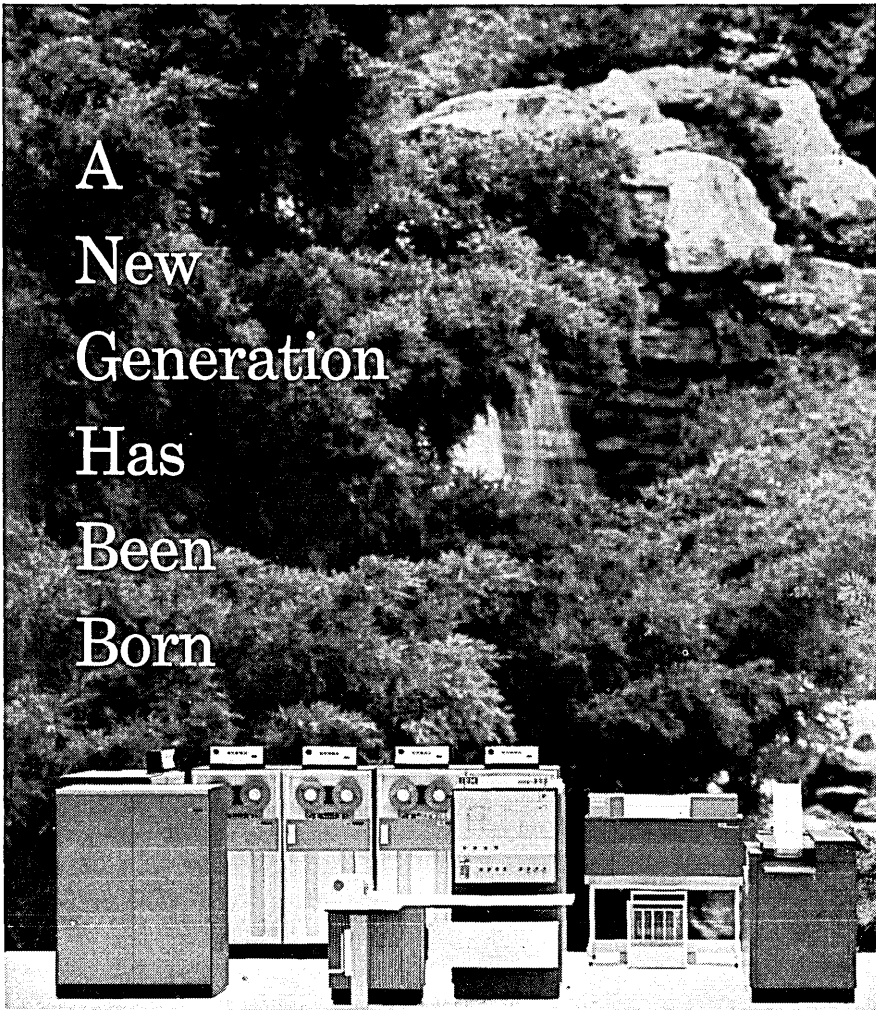

MCDONNELL Installs IBM System/360

The McDonnell Automation Center has installed the first of 18 "new generation" computers. Our Model 30, the first to be delivered to a commercial user, makes available to McDonnell customers the most advanced data processing equipment in use.

The System/360 permits us to handle even broader applications for even more types of businesses than we did before. If you are concerned with techniques such as mathematical programming, simulation, statistics, and matrix manipulations; or applications such as payroll, inventory, manufacturing control, billing, and financial accounting; or other data processing and computing procedures, we have the *experience*, the *personnel*, and the *equipment* to assist you.

For further information, write or call the Automation Center closest to you.

Consulting • Systems Design • Programming • Data Processing and Computing

MCDONNELL AUTOMATION CENTER

DIVISION OF MCDONNELL AIRCRAFT

Box 516, St. Louis, Missouri, 63166 Tel. (314) 731-2121

Colorado Office: **DEL COS** Denver - Tel. (303) 534-6291

Texas Office: **MACTEX** Houston - Tel. (713) 224-5921



CIRCLE 17 ON READER CARD

DATA MATI ON

Computer and

Pull yourself

Every now and then thought long range career objectives

All too easily, the two can be

To those who are reviewing future, we offer an inviting suburban Boston facilities.

The continued success of more positions than at any time to consider a career with

These opportunities span technology, with emphasis in

Logic Design
Design & Packaging
bility Memory

Software Development
Conversion
Techniques
Development

Interested candidates at 200 Smith Street

H
ELECT

NOTE: ACM and WESCO (collect) on arrival

Opportunities exist in other Honeywell Division

featuring a 1.4-usec core cycle. The big news, though, is promised delivery of two months for the 660 and 670. The big questions: has SCS come into the game too late? does it have the dollars to stay the limit?

Another new firm is Logic Corp., out of Philly (see this month's News Briefs). We're crossing our fingers for all of them.

NEW CDC PROCESS COMPUTER

Look for Control Data to announce a new process control entry, aimed rather directly at the IBM 1800. It's the 1700, a 16-bit-word, binary, single-address machine with a 1.2 usec core (4-32K), said to be about twice as fast as the 1800. Minimum software, aimed at keeping costs down, will include Fortran IV, a macro assembler, and a time-sharing monitor. A "typical" system, including 16K core, two unbuffered channels (one for paper tape, teletype), will cost around \$1500/month. Additional buffered channels, interrupts, and plenty of peripherals will also be available. CDC will also soon unleash a big new disc file.

HOW FAST THE COBOL, HOW HIGH THE COST

IBM is predicting that its Cobol compiler for a 256K-byte 360/65 will compile 4000 statements per minute. The only catch is the cost: the system must include the 4-million-byte 2301 drum (which, with its control unit, costs \$6700/month) and four 2311 discs. For less dough, 360/50 users can settle for 1000 statements a minute, matching the fastest Cobol compiler available (Honeywell 1800).

Making the speeds even more significant is the word of an IBM spokesman at DPMA who indicated 360 PL/I compilers may be "as fast as Cobol." If true, it substantiates claims that the 360 facilitates compiling, weakens argument that an efficient compiler couldn't be tailored for ungainly PL/I.

MAG TAPE MARKET DUE FOR SHAKEUP

Look for a big shakeup in the \$35-million computer mag tape market: the IBM-3M combo which has gobbled up most of the business to date may be breaking up. The tipoff: 3M has been making sales calls. While IBM reportedly constructs a factory in Colorado and 3M builds a sales force, the other tape makers will undoubtedly exert extra effort to woo away their customers. And it's a good bet that other companies, Eastman Kodak among them, will enter the fray.

RUMORS AND RAW RANDOM DATA

While CDC was shipping out the 3600 from its LA service bureau and phasing out its 1604 there, the 1604 University Computing bought from CEIR was back home in LA, having given way to a 3400 at its old home, SMU...Rumors are strong that IBM has bypassed the RFP route to get an order for six 360/75's to upgrade the 94's & 490's at NASA's Houston Mission Control Center...Look for EAI, No. 1 in analogs, to announce another hybrid system in Sept., smaller than their first entry, the 84/8800...Munitype, NYC outfit, is offering a time-sharing service for calculation of municipal bonds for \$300/month plus terminals, etc. on a GE 215/Datanet 30, hopes to land 100 clients. Look for a passel of others to leap in T-S bureau business. Dartmouth's Bill Zani will open one in Boston. Others are looking at Seattle, SF, LA... IBM is said to have a 360/95 in the works with a 4-500 nsec. cycle time; it'll be bigger than the 6800.

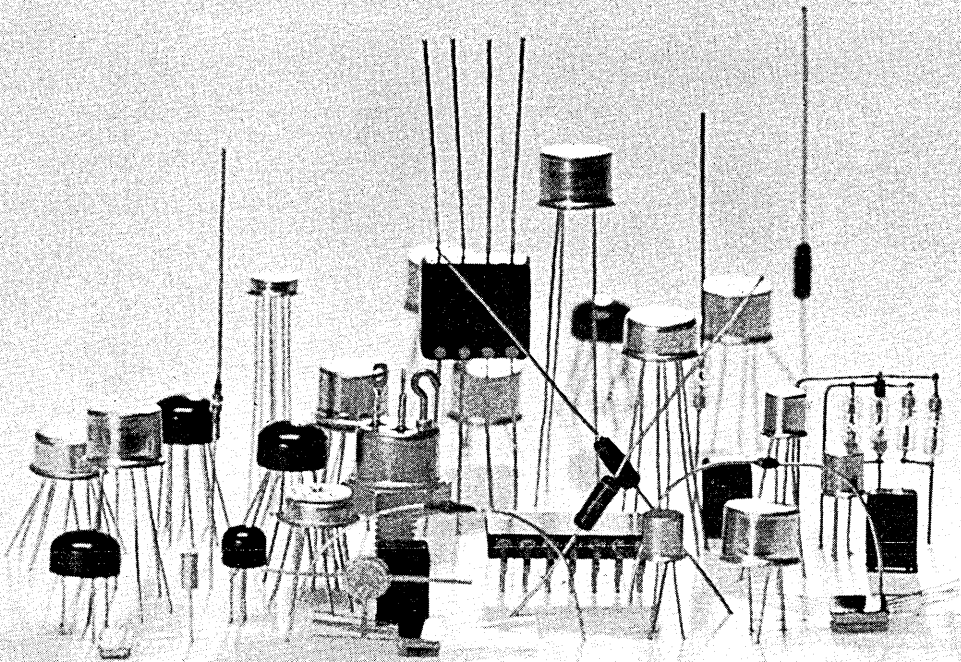

Fairchild gives you a wider choice, including... a too-fast diode.

For the generation of computers now in work, we supply transistors (switches, amplifiers, core drivers); diodes (fast, very fast and ultra fast; in DO-7, Adam and epoxy packaging; multiple assemblies, matched pairs and quads); monolithic integrated circuits (two families of DT μ L, the CT μ L family, the TT μ L family and two families of RTL — μ L and MW μ L); plus Fairchild custom integrated circuit capability, hybrids, multiple assemblies and thin film. And for the next generation, we ship, off the shelf, devices such as the DO-7 picosecond computer diode. Who else does as much? Nobody. So why not let us do more for you?

CIRCLE 18 ON READER CARD

FAIRCHILD

μ L, DT μ L, TT μ L, CT μ L, MW μ L
are Fairchild Trademarks

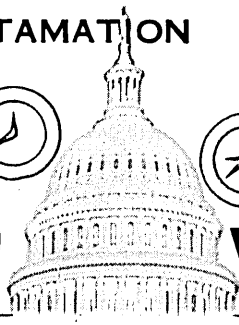

WASHINGTON REPORT

GSA STUDIES SCERT FOR FED-WIDE USE

The General Services Admin. is practising what it soon may be preaching under Budget Bureau circular A-71 (April, p. 70). The federal housekeeping agency employed SCERT (System Computer Evaluation and Review Technique) to aid in selection of 10 large-scale systems to replace existing computers at regional offices.

These simulation programs, a product of Compress Inc., D.C. software house, provide procurement officers with objective comparison data on which to base selections. With its mandate from BOB to bring some order into frequently-chaotic agency selection procedures, GSA is leaning towards establishing use of SCERT-type programs as standard operating procedure. To be decided: Should GSA recommend the 26-program SCERT package as is, attempt to have new programs written according to its own specs, or try some combination of the two?

STATE, LOCAL BOYS UP COMPUTER USE

Local and state governments, moving somewhat belatedly into the thickets of automation and feeling fiscal and other thorns, are seeking help from their Federal Big Brother. An estimated 300 computing systems are now in use by state governments but this total is acknowledged minute compared to their computable work loads. State officials are seeking to work out formal arrangements to share federal computer facilities located in home bailiwicks, something now done occasionally on an ad hoc basis.

The Council on State Governments is also looking into the feasibility of organizing joint federal-local-state computing facilities to both split costs and make available federal computer expertise in the provinces. Budget Bureau officials are interested in these proposals because so many programs involving federal monies are administered locally. It's estimated, for example, that some \$25 million, all of it federal, is spent by states solely for dp pertaining to unemployment insurance.

CHESS IS OUT, PING-PONG IN

At Project MAC, a PDP-6 computer in tandem with a paddle attached to a steel rod, a TV camera and an image digitizer will soon be playing table tennis with human opponents. Research points towards development of true "robots" for sophisticated feedback work in rugged environments. It may also help us get the ping-pong championship back from Red China.

BITS & PIECES

The Advanced Research Projects Agency has awarded the Univ. of Michigan a \$500K contract for research in graphic I/O. The grant is believed to reflect a turning-away from time-sharing as the principal focus of ARPA-sponsored research...Debut of the Advanced Record Service of the Federal Telecommunication Service, originally set for mid-summer, has been shoved back to December 1 or so.

Announcing the Bryant PhD-170: world's first mass memory with private party lines.

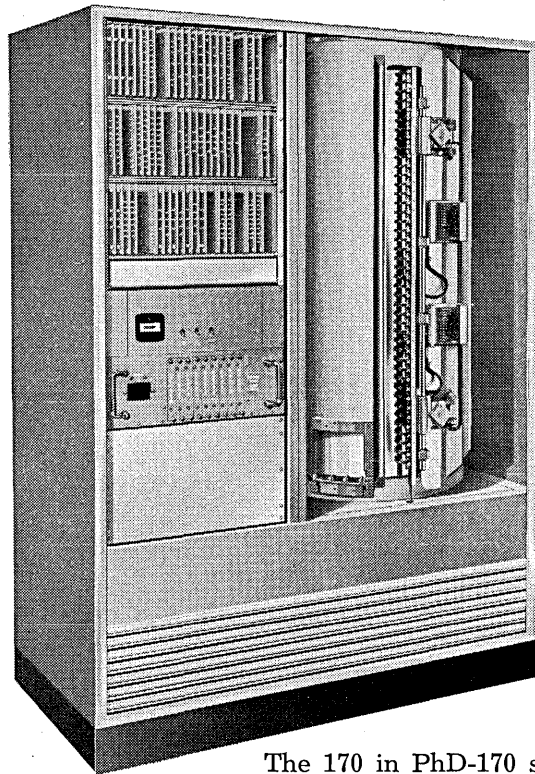

The correct term is independent, simultaneous multiple access. And it's brand new. No one else has it.

It means that one, two, three, or four groups of independently positionable read-write heads (up to 43 in a group) can now gain access to the same data stored in any one of 64 assigned tracks. At the same time.

The 170 in PhD-170 stands for 170 million bit storage capacity. With every bit of it ready for exceptional programming flexibility. Also it's the lowest cost memory of its size.

The PhD-170 is a new breed of random access memory that will work wonders in banking, inventory control, stock market transactions plus other applications not previously considered possible.

Learn the whole story now. Send for publication #BCPB 109-5-65. To refresh your memory.

BRYANT

COMPUTER PRODUCTS

A Division of EX-CELL-O Corporation

850 Ladd Road • Walled Lake, Michigan 48088

CIRCLE 19 ON READER CARD

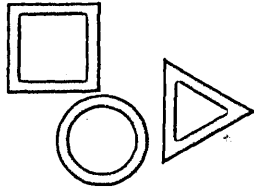

EDITOR'S READOUT

PROFESSIONAL SOCIETIES . . . OR TECHNICIAN ASSOCIATIONS?

The DPMA wound up its latest conference in July, and this month ACM gets its turn . . . which is probably as good an excuse as any to devote an editorial to the two organizations and the question of what are the responsibilities of a professional society.

To its members it owes programs, publications and plenty other means of progressing professionally. In addition, it should serve the traditional morale function: helping members feel they're part of something important and progressive.

To the entire industry or profession (not just numerical analysis or commercial edp), a society owes its aid in formulating standards and other stimuli to advancement. It owes the profession help in making the industry more competitive (this based on the assumption that competition in a free enterprise accelerates progress).

And to society at large, the society owes the information which can help the people and their legislators, industrial leaders and educators to intelligently evaluate and guide the use of information processing machines and techniques.

The two societies claim the same goals for its members: education. But the educational programs are as different as the two memberships. ACM members tend to be more experienced *computer* people; they're more interested in the insides of the machine and the software and the mathematics behind it than in applications and installation and personnel management. DPMA members still tend to know more about wiring a plugboard than they do about computers or information processing . . . although the certificate exam program and improved national conferences are tending to change that. Member interests are pretty well restricted to commercial data processing . . . and the efficient management of an installation.

The DPMA educational program, a bootstrap approach, seems more clearly aimed at title and salary advancement than at professional growth. The ACM, offering higher-level technical publications, nevertheless claims to be all things to all people, but slights both commercial data processing (except at highly technical levels), and mundane, practical problems of almost any kind.

Neither organization, it seems from here, has done much for its industry or for society as a whole, although individuals in individual ACM chapters have contributed significantly to local high school educational programs. And ACM, through its participation in AFIPS, has supported a few fitful outside educational efforts.

This is not to debunk or to diminish the efforts of sincere and hard-working members of ACM and DPMA. Both organizations have done significant work to increase the level of competence of their members. But we think the time is ripe to more clearly define larger, more important long-range goals which distinguish a professional society from a technician's association.

on
the cover

THE RAND SYMPOSIUM

defining the problem

The RAND Corp. has once again given us permission to quote from the transcript of their annual symposium, chaired this year by Dan McCracken of McCracken Associates. Others attending the meeting and their affiliations:

Paul Armer, The RAND Corp.

Robert Curry, Southern Railway Corp.

Barry Gordon, The Service Bureau Corp.

Fred Gruenberger, The RAND Corp.

Richard Hamming, Bell Telephone Laboratories

William Hosier, Sylvania Electric Products

Major William D. Marsland, Jr., U.S. Air Force Academy

Kenneth Powell, IBM Corp.

Walter Ramshaw, United Aircraft Corp.

Frank Wagner, Informatics, Inc.

Mrs. Bernice Weitzenhoffer, IBM Corp.

Joseph Weizenbaum, Massachusetts Inst. of Technology

The first subject taken up was: "What are the significant problems facing our profession?" Problems mentioned included establishing adequate training programs in the universities, social implications of computers, and amateurism vs. professionalism. On the last subject:

HAMMING: Let me suggest that [there] are variations of professionalism. . . . If you go to a doctor and ask him to cut off your big toe he'll listen to you and consider what you say, but he will do it only if he is convinced that it should be done. In the computing field, as far as I know, almost no one will ask himself, "Should this problem be done this way?" . . . I think that is one of the marks of professionalism and it goes into the social implications. Professionalism is not a question, I think, of organization; it is a question of individuals taking on themselves the feeling that they are responsible for what they do.

WEIZENBAUM: . . . Atomic scientists said after 1945 that they felt they had known sin. They started publishing

a bulletin. It may well be that by 1984 (or some such magic year) computer people will start publishing a bulletin with the clock hands showing five minutes to twelve.

GORDON: Or five minutes after twelve, perhaps?

WEIZENBAUM: Yes. There is some probability that computer people will have that feeling. In effect we sense it in advance. Perhaps we are now in a position to so behave that such feelings won't be necessary. Consider Hamming's point that there are some things we ought not to do even though people will pay us to do them.

HAMMING: Then let me go on. In my own corporation I am one of the few people who has regularly said, "I want to know whether the problem is worth doing before I spend my life doing it." I have refused to do problems, and I have changed problems to the form I thought they should be. I am willing to work with a man but I am not always willing to do what he says. Yet when I look around among my colleagues I find very few who have had the courage, over a long period of time, to select the problems that they felt were worth doing and work on those, and refuse to work on ill-conceived ones. Quite recently we had a problem which I exposed as being ill-conceived and the man involved admitted it, so I said, "I'm not willing to work on a problem that you yourself admit is foolish."

GORDON: I think there is a significant difference between an uncooperative individual and a member of a profession. Your analogy with doctors is one that I have thought of to some extent over the last year. I think that one of the things that makes a doctor a professional is that he has two independent allegiances. Many large corporations employ doctors. If the corporation says, "We think we should inject each employee with penicillin once a week to cut down absenteeism," the doctor says, "No, that is not good medical practice." He has a set of professional ethics and his Hippocratic oath to fall back on to support his stand.

I'm not arguing with you; I'm simply trying to extend this further. The computing man has little to fall back on. If his corporation says, "We are going to put all these EAM procedures on our model x computer simply because it is more prestigious," the computing man has nothing to

fall back on to enable him to say, "No, this is not good computing practice." The best he can be, perhaps, is a conscientious individual. Until you have some kind of professional organization that can establish guide lines and rules for good and bad professional practice, for ethical and unethical professional behavior, then you deal as an individual with the world, including your corporation. There is the significant difference between the computing world and the medical world.

HAMMING: Many doctors work in very large organizations called hospitals, and they find themselves there in the same positions that we do in corporations. The organization is bigger than they are and they have to cooperate, and yet they can maintain the sense of "I'm not going to spend my life doing things that I think are wrong."

WEIZENBAUM: You weakened your argument earlier and now I think you have restrengthened it. Earlier you talked about problems that were not worthwhile; now you're talking about problems that are *wrong*. There is an important difference. An important characteristic of the doctor in our society is that he is one of the few individuals licensed to kill. If someone tells me he has a headache and I tell him to take castor oil and he dies—then I am criminally liable. If the doctor prescribes the same thing, then it is a mistake in judgment.

I mention this to make a point. Society recognizes that a doctor deals with potentially dangerous things. This is one of the reasons why the practice of medicine must be a profession. Now my point is that we as computer people are also dealing with potentially dangerous instruments. Therefore, a standard of what is worthwhile and what is not worthwhile and of what is right and wrong, and which can lead an individual computer man to a position where he must say "I will not do this" needs to be developed. This is the type of professionalism that we certainly do not have today. It isn't even visible on the horizon. . . .

GRUENBERGER: . . . Suppose you're in a university computing center and one of the social-type scientists comes in with 3500 responses that he has *already* received to a questionnaire with 85 questions on each schedule. It is typical of such people that that is the first time he begins to worry about what to do with the mass of responses. You look it over and you find that it's absolutely

pure garbage. He has asked 85 completely nonsensical questions. If we tabulate these responses (and especially if we cross-tabulate them) he will have several thousand pages of new garbage derived from the old garbage. Now supposing you say to him, "This is garbage and I ain't gonna do it." (It might be better if you told him to go off in the corner and count the responses on his fingers because that's probably the correct way to do it, and moreover it will keep him out of mischief for a few years so he can't send out any more questionnaires for a while). Now, what is he going to do? First of all, of course, he will complain to the dean. His second response is likely to be, "All right for you, if you won't do it we'll get our own computing center."

HAMMING: . . . What you should say to him is, "I, myself, am not going to do this kind of work but the computing center is open to you." There is a difference. After all he can go to the library and get any information he wants. We can't prevent him from using the library, and in the same sense we don't have to do his work for him, but we can't prevent him from using the computer.

GRUENBERGER: You're actually going to let him chew up the computer time?

HAMMING: I don't see how you can prevent him from doing this.

GRUENBERGER: That's like the doctor saying "I won't cut off your toe, but here's the knife."

HAMMING: No. The doctor has no way of preventing the man from cutting off his own toe.

GRUENBERGER: But the doctor doesn't give him the knife to do the job with.

HAMMING: He doesn't have to.

MARSLAND: We're begging the question. Why couldn't the man himself realize that he had a poorly defined problem?

HAMMING: If he could easily recognize that he had a poorly defined problem, then he would probably never have gathered the original data.

GRUENBERGER: You'll never convince him of that. Besides, as I defined it, he already *has* the responses and he's spent a fortune on postage alone getting them.

MARSLAND: So the real problem is how to get people to understand what constitutes the well-defined, worth-

while problem.

HAMMING: And that's the problem of all science.

CURRY: We had a situation in our company not too long ago where the lawyers wanted some information about how the other railroads were mishandling our cars. He didn't want to let me run data on how our railroad was mishandling other railroads' cars. But I went ahead and did it anyway and he got both of them whether he wanted them or not.

WEIZENBAUM: There's a technological development that has a bearing on this. Anyone who can get to a TWX and who has the proper number can have access to the Project MAC computing facility at MIT. Once on the system he can do anything he pleases. We specifically look at MAC as an experiment in a public utility, hence using the computer is much like using a telephone. No one has a higher priority than anyone else and there is no monitoring.

I feel that in a reasonably short time computer access will be just that easy for almost everyone. I would imagine that some organization will establish very large computer centers that will be time-shared. Then one will be able to go anywhere and get access to the machines.

The telephone can clearly be misused. Bookies have been known to misuse it; gangsters have been known to make a telephone appointment to kill people. That's too bad and we'd like for the telephone not to be abused. But the alternative is to listen in on everyone's talk. We have to imagine someone being able to say, "This is dangerous, we'll have to cut this man off." We will soon be in a position where people can access a computer very much as they presently access the telephone. Then the social consequences of saying "You may or may not use this instrument" will be much wider and much more dangerous than the social consequences of censorship.

McCRACKEN: I think that's probably right. The computer is a useful tool and it must be made available. We could be sitting here in the same context and talking about the printing press 500 years ago. We could be talking about how important it is and how much an instrument of the devil it could be, but it isn't going to get that way.

WEIZENBAUM: The trouble with the printing press is that it makes it easy to lie to people. But the alternative is censorship, and we know that that's much worse.

GORDON: We could agree that there are certain things that are called privileged equipment and certain things that are not. Firearms, for instance, can be called privileged equipment and there are restrictions on their availability. Telephones, on the other hand, are not privileged equipment. We seem to agree that computing equipment can be dangerous but not as dangerous as firearms but merely as dangerous as the telephone. Therefore, it should not be privileged.

McCRACKEN: Isn't the position of the telephone company like, "We're not going to check on the use of this equipment that we are installing in this second floor room with the tables and the betting slips," and so on? Are we really just bystanders in this operation?

WEIZENBAUM: In that sense we are. We think of the computer as an information handling device. It seems to me that it's pure black and white, that either we decide to control the information handled by the device or we decide not to control it.

McCRACKEN: Are you suggesting that we abdicate responsibility for controlling it?

HAMMING: I don't see how the alternative is feasible.

GORDON: I can't agree that it's black and white.

You're trying to make the issue binary where it really isn't. Consider for example the large data files that will exist in a few years. The federal government is already working on such a file for which they will collect every bit of data that they can get on government employees for security purposes. They will be collecting all sorts of information ranging from credit rating to a record of arrests. All this information will be on file, presumably for security purposes. Now, obviously we can't allow anyone who can get to a TWX to have access to this information.

HAMMING: But the responsibility lies with the man who created the file, not with the computer expert who might have to process it.

WEIZENBAUM: And you don't protect it simply by saying that anyone who can get to the computer can have access to it, and vice versa.

GORDON: My point is that it is not simply "yes" or "no." You have to have gradations along the way.

WEIZENBAUM: It must be "yes" or "no" as to whether you are going to permit access to the device. Notice, though, that with the telephone there are things like unlisted numbers and secretaries who buffer people so that it is far easier for me to call my wife than for me to call the President of the United States.

In any event, there is a vast difference (and I think it is dangerous to overlook it) between restricting access to the instrument and restricting, in some sense, what one can really do with the instrument. (For example, trying to call information for an unlisted number). The unlisted telephone numbers are a protected file and I cannot have access to it. . . .

WEIZENBAUM: I'd like to try to steer in a slightly different direction. . . . We have all observed the following situation. A man writes a computer program to solve simultaneous linear differential equations. It could be any method—Runge-Kutta or whatever. An engineer walks in and says, "I have a set of differential equations here that I want solved." The computer man says "What method would you suggest? What can you tell me about these equations? Are they stable? Over what range? What are their characteristics? etc. And the customer says, "I don't know, don't you have a differential equation solver lying around?" And the computer man would naturally say, "Yes, we have many differential equation solvers listed here in our library." And the customer says "I don't care." And as a result he will get some numbers representing a solution, and on the basis of those numbers he'll build something.

We've all seen that take place. Now that the profession is getting a little older we see something else. Supposing someone writes a personnel program . . . and let's say part of his program was designed to decide whether or not to hire a particular candidate. The applicant is given some psychological tests. The test scores are entered into the program and the output is some sort of a profile. The personnel man gets this output and he knows the weights that were used in the computer program. He knows how the figures in the output are significant and how they are not. Then on the basis of talking to the individual and using the computer analysis he makes his decision to hire or not to hire.

Now, a year or so later the man who wrote the computer program is gone and the personnel man who knew all about the program has left. A new man is sitting in the personnel department and he finds that the easiest way to justify himself to management, in making decisions, is simply to rely on the profile. He has no idea, in an absolute sense, how the thing works. He knows nothing of the derivation of the numbers that he sees or the hypotheses that went into the analysis. The result is the inhuman use of human beings. Fundamentally the trouble here is that

everyone has forgotten (to use the popular parlance) how the computer made these decisions.

I say that we have here a very general problem and a very general danger. People write computer programs that are not documented or the documentation is very difficult to follow. Eventually people forget, or the information is lost as to how the solution was arrived at. Nevertheless, the computer solution is used as a recommendation or even as a decision. In that sense the popular nightmare of the computer controlling humans is in fact realized. . . .

Another subject considered was: "What should a college graduate know about computing today and five years from now?"

McCRACKEN: We have with us a man who is responsible for training many hundreds of future non-expert users. I'd like to hear from him on this point.

MARSLAND: I originally raised the question of what a military person should know about computing today and five years from now. At the Air Force Academy now, every Air Force cadet is required to take a course in computing. The same thing is true of West Point, and I'm not sure about the Naval Academy.

The problem is, what should these people be given? We have two courses. One is for people majoring in science, and I have a feeling that they are not getting the insight that they should concerning data bases and the problem of formulating a problem. I believe that the non-science people are getting a better course in that respect. What should we be putting in these courses so that these people will not make the mistakes you are talking about?

McCRACKEN: You have the floor and you're in a position to define such a curriculum. Take the guy who is going to use two hours of computer time to reach a decision on a budget. What should he have learned in college so that he'll have enough sense to ask, "What assumptions went into this program?" That seems to me a fairly specific thing to wish that people would say.

GRUENBERGER: Maybe you've defined the end goal right there. Maybe that is the thing that should be tattooed on the forehead of the student: "What are the assumptions that went into this program?"

WEIZENBAUM: Maybe the English approach will turn out to be correct. They like to turn out what they call, simply, educated people, whether that education is arrived at through the classics or whatever. We are talking here about people who are sensitive to reality, who are in some sense humble, who can ask good questions and who know what a hypothesis is. The problem seems to be general and not restricted to computer training.

POWELL: There are two things, I think, that everyone should be given in a training program. One is history. Students should know how things got the way they are. For example, we say that computers really only manipulate symbols. If we look at history closely we find that Lady Lovelace knew that at the age of 20 many years ago. She understood it fairly clearly. We need more of these facts. Incidentally, if such a fact is given to a new trainee as a bright new idea, then his reaction will be much different than if it were presented to him as something a hundred years old.

The second thing is that the concept of "order of magnitude" ought to be communicated to the trainee. For example, in the United States one out of every 20 high school students has been under the watchful eye of a computer program for the last five years. Already one in 20 is being watched by a computer—his habits, his parents'

habits, his performance in school, and so forth. I regard this as sort of a dangerous trend. Under these conditions, people like Edison and Einstein might be rejected (and maybe made into coders).^{*} Thus, 1 in 20 is an important number.

These are two things I regard as important. We need history so that we know what happened and we need a feeling for an order of magnitude so that we know when to start being concerned.

The conversation then led to further problems of education, an item listed on the agenda as: "What should a decision-maker (whether industrial manager or military commander) know about computing today and five years from now?"

WEIZENBAUM: . . . At MIT there are presumably many people who know much about computers from many different points of view. I am one of the few who has an interest in computers in behavioral science. I am reasonably competent in computers and at least sympathetic to the behavioral sciences. I have all I can do to keep from over-committing myself in this direction.

Now one of the things I try is to get a curriculum started at MIT. People who are interested in computers from the behavioral science point of view then can get a course in computing from the non-numerological point of view. They will not have to go through FORTRAN courses that are laced with instructions of the form: "If less than zero do this; if greater than zero do that," and so on. This latter viewpoint happens to be dominant at the moment.

I am at the same time teaching a course called "Introduction to Automatic Computation" which is an ancient and honorable course. Other people teach it as a programming course, but I'm teaching it from a different point of view. I start by pointing out that the computer is a symbol manipulation device and that arithmetic is a small subset of symbol manipulation. If the students get anything at all out of this course, through actual coding practice, it should be an appreciation of how terrible human beings are at manipulating symbols. If they don't learn very much about coding, that's all right with me. I do want them to appreciate the fallibility of the human being. But I want them, also, to know what the computer is in a larger sense. I want them to understand that if you have a poor solution to a problem, then clever coding will not help much. I strongly support Hamming's remark that people are crying for help and that when it is offered you have all you can do to keep from over-committing yourself.

McCRACKEN: Of course sometimes it's discouraging to go to someone who has been crying for help and tell him what he needs to know, and at the end of the talk he says, "That isn't what I wanted to hear."

HAMMING: One of the big problems in teaching is to listen and find out what it is that the man wants, rather than giving him your solution in advance.

I feel that Joe represents a perfect example of what I mean. An individual, say at MIT, decides that this is the way it should be done and he does it. Someone else may decide to do it differently but I have great faith in the truth.

POWELL: That means that you are teaching the philosophy of computing in your course.

WEIZENBAUM: That's right.

POWELL: Therefore you know how to test for it?

WEIZENBAUM: There may be another alternative. Suppose we picture a man at MIT who is like me, with

^{*}See Martin J. Klein, "Einstein and Some Civilized Discontents," *Physics Today*, Jan. 1965, p. 38.

the same aims and attitudes. Supposing this man says, coming to MIT, "This FORTRAN stuff isn't any good; how can it be fixed?"

One of the alternatives would have been to seek organizational and political solutions to the problem by surveying heads of departments and other such people. It would be easy to spend two or three years, more or less full time, convincing the heads of departments and the Institute itself that curriculum changes were needed. Perhaps it would be possible to convince them that changes were needed, and perhaps not, but in either event at the end of two or three years nothing would have happened. MIT is a fairly free place and I have the prerogative of not asking people, but just doing. By example, and by popular demand perhaps, one can demonstrate that he has something good that is needed. I am sure that five years from now there will be many such courses. Not because anyone did politicking (which goes back to the individual versus the organization) but because *someone* did it . . .

Considerable discussion—but little agreement—then followed on the subject of whether individuals or organizations were best suited to spread enlightenment and press for educational programs. It was generally agreed, however, that a greater volume of writing, especially in book form, by computer professionals should be a goal. Such work could then be offered as text material to the universities. Members of the group also hoped that general periodicals could be induced to take a greater interest in offering more accurate and informative articles about computing.

The group then took up item 4 on the agenda: "What are the implications of the current trend toward remote console time-shared systems?"

McCRACKEN: . . . One implication that we have with remote consoles is that you're going to have to make up your mind that you're going to let anyone do with it what he pleases simply by dialing up the magic number.

HAMMING: Let's be clear about this matter. I believe it will be possible for an individual to put in or create his own information and get back the results of computation on it, but will not necessarily be able to have access to everyone else's information.

GORDON: There are three levels of the use of one of these systems. One is the level Dick was just mentioning, wherein you put in stuff of your own, operate on it, and get out the results. The second is the situation where you may or may not put in information of your own, but in any event you have the ability to use (in the sense of interrogate) information that is already in the system. The third level, and the most critical, is the situation that gives you the ability to make changes on information that is within the system. You might categorize these three levels then as the ability to ignore things in the system, the ability to use, that is inquire, about things in the system, and the ability to change things in the system.

HAMMING: I anticipate all three levels in use at the Bell Labs. I have on my mind having files with records containing everything from salary on up. I envision preventing people from having access to information they have no right to, simply by putting combination locks on the thing and have the combinations changed regularly. Only a few pros coming in from the outside will have the ability to change the system. The vice presidents will certainly have control over what the system should do and

what information should be given to whom.

WEIZENBAUM: That's exactly how it is at MIT.

GRUENBERGER: It seems to me that there is a profound implication in the teaching of computing when we will be dealing with remote consoles. The system is so much different from those we've used in traditional courses in the past that the traditional subjects (many of them) become nonsense.

WEIZENBAUM: I'd like to give an example. I was at a meeting some weeks ago at Hanscom Field; Saul Gorn and John Carr III were also at this meeting. John Carr was much worried that people who had not taken courses in mathematical logic were getting access to computers through a typewriter. He raised the question, "Can people who know nothing about computers be given access to a computing system and if so, will what they do make any sense?" His conclusion was that they could not. Saul Gorn supported his view very strongly. In particular, Saul pointed out that you ought not to be able to tell a computer to do two contradictory things, or to give the computer ambiguous instructions. I argued with him, and still do, that the situation is vastly changed when you're dealing with remote console equipment. You can indeed issue contradictory or ambiguous instructions to an on-line machine. Something will happen and since you can see what the consequences are, you can take corrective action, or follow the lead, or whatever you want to do. This is vastly different from trying to anticipate every contingency, punching the whole program on cards and then feeding it to a machine and waiting for results. This is one of the things that is going to be greatly different when people get on-line. A person will be able to explore a solution space as well as tell the computer "solve this problem" which simply means that a stated procedure should be followed to its conclusion.

There are many bright people—well respected—who have fallen behind because they have not yet had the experience of interacting with a machine through a typewriter. I'm suggesting that this experience is a little like psychoanalysis. You can't tell anyone what it's like or appreciate it until you've tried it yourself.

McCRACKEN: Would you care to elaborate further on that?

WEIZENBAUM: There are profound differences between operating on-line and using even the best of conventional systems where the turnaround may be as low as an hour, as it is, apparently, at the Bell Telephone Labs.

Suppose you are communicating with someone in Australia by mail. Supposing the turnaround time is a week and you want to communicate with him, tell him to do certain things, to send you certain things, and so on. What sort of a letter do you write him? You may want to make your letter conditional: if this, send me that; if that, do this, and so on. That is one way of communicating with him. Another way is to pick up the telephone and talk to him. In the latter case your communication is entirely different. Now you need not anticipate conditions; you simply say, "Do this and tell me what happened." When he says "It turns out to be such and such," you say, "That's fine, now do this." You can even say to him, "Oh, I didn't expect that, let me think for a minute." This is the essential difference in on-line operation. At first glance it seems that the difference is turnaround time but on closer examination that isn't the significant operative effect.

You might conjecture that operating on-line with a computer is similar to having a G-15 all your own. Again, the issue is more profound. Not only do you have raw computing power at your disposal, but at a MAC-like facility, you have disc files which put half a million words

of program at your disposal. I can use this powerful set of programs. I have at my fingertips the MAD compiler, powerful editing languages, list processing languages—all in all I have access to some 15 different languages through my typewriter. This is significantly different from simply having access to your own computer. One of our big problems now is to design languages which interface well with the hardware and which take advantage of our new tool.

McCRACKEN: Are you saying that we are going to have to learn how to act differently with a machine, or the language that we use will be different, or the questions that we ask will be different, or what?

WEIZENBAUM: All of these and then some.

GORDON: The requirements on advance planning seem to be less stringent with such a system too.

McCRACKEN: What about the man who is running a problem that takes 10 hours of machine time once every week? Is his life going to be different?

WEIZENBAUM: Let me talk about that from a different angle. We get lots of visitors at MIT who come to see MAC. Almost all ask about the economic justification of the system. They invariably ask a question of the following form: "Supposing I have a program that runs 10 minutes on a 7094, and suppose I took that very program and ran it in MAC; how much machine time would it take?" I maintain that that question makes about as much sense as asking "What is the multiplication time on STRETCH?" You can ask the question and there may in some sense even be an answer, but if one is really trying to get at economic justification then that is the wrong question.

First I point out that a problem in economics is a problem of the distribution of scarce resources. If you are shipwrecked in Lake Michigan you do not have a problem of water economics. If you are shipwrecked in the Pacific Ocean you do have such a problem. In the one case drinking water is a scarce resource and in the other case it is not. What scarce resource are we talking about when we consider time-sharing? Most people make the naive assumption that it is computer time. It is not. The scarce resource we are talking about is people.

There are very few people who are really good at doing anything with computers. The situation here is no different from other fields. With time-sharing you can multiply the effectiveness of people greatly. This is why small countries like Hungary or Turkey or Israel will naturally turn to time-sharing. They have even fewer people. In this country we behave as if we can afford to be wasteful, force people to punch cards and to go through the usual procedures . . .

I happen to have a MAC console at home. A question people ask me continuously is, "What do you do about long printouts?" They are apparently appalled at the thought of using a Selectric typewriter for reams of printouts. The answer, of course, is that I don't ask for reams of printout. I don't ever need to. When I want to know what a particular number is, I don't need to ask for 10,000 numbers on either side of it; I get that number.

GORDON: How about the situation of a payroll where each guy wants to do his own check?

HAMMING: We're not talking about that situation.

WEIZENBAUM: But there's an answer to that question too. And the answer is, just as with everything else—list processing, compiling, marriage—there are certain tools, certain customs, certain conventions appropriate to certain situations which don't apply to other situations. One of the mistakes that died-in-the-wool IPL-V'ers frequently make is that they think list processing is the answer to all problems, but it isn't. List processing is not the answer to every conceivable problem, nor is compilation, and neith-

er is time-sharing. If I were in the position of advising the man at Lockheed, for example—which has, I understand, a fantastically large computing facility—I don't doubt that I would tell him that some of the things they are doing should unquestionably go on a time-shared system and some of the things unquestionably should not.

McCRACKEN: Would anyone care to estimate what percentage of the world's computing problems should go on a time-shared system?

HAMMING: You can characterize the type of thing that should go on a time-shared system generally by saying that it is the exploratory type of computing.

ARMER: You might want to *modify* the payroll program from a time-shared console, for example.

WAGNER: Or you might want to take care of an exception like the guy who just got summarily fired and you want to issue a check for him.

McCRACKEN: Could we say that five years from now programming will be done with a typewriter in each two-man office?

MANY VOICES: Sure. Why not, it's the perfect programming tool.

ARMER: There'll be a lot of it done that way around here next year.

WEIZENBAUM: Let me describe what happens with batch processing today. A scientist or an engineer has a problem. He intellectually explores a possible solution to this problem. He finally arrives at a particular solution which he then encodes and takes to the computer. The solution may be good or bad. Time-sharing, when it is appropriate, allows the man to explore the solution space itself, with great efficiency. He has a high probability of converging to a solution without having to go through a process of sampling a great many solutions. I think that is the essence of it.

WAGNER: McCracken asked for guesses as to the percentage of work to be done on time-shared systems five years from now, and I suggest that the unit that we use to measure be my old favorite—money. I suggest that we guess at the percentage of machine installation costs that are used in a time-sharing mode five years from now.

WEIZENBAUM: The computing field, like many others, is full of improper dichotomies. In computing, for example, we draw a line between compilation and interpretation. We all know there is no hard-and-fast line between these two. I say that 10 years from now, and probably very much sooner, it will be very hard to tell in most cases what is being done in pure time-sharing and what isn't. To illustrate what I mean, we have a situation today at MIT on our 7094's where we have a category called "background." I can take a FORTRAN deck, for example (that may have come from Stanford) and I can submit it to the MAC time-sharing system as a batch processing run and it will be done whenever the machine isn't servicing anyone else. It is done in what we call "background." It may actually be run late at night. The question then is, is this time-sharing or is this batch processing? Even in a primitive system like MAC this question begins not to make sense. Ten years from now the question won't make sense at all.

A question that I think makes much more sense right now is, what is the role of small computers, especially considered in the light of availability of time-shared systems?

POWELL: Aren't you already experimenting with this? Don't you have some small computers hooked into the large one?

WEIZENBAUM: No, I'm not referring to those. I mean free-standing small computers. I don't know the answer myself.

HAMMING: Consider the telephone central office which

I regard as a computer with up to 10,000 remote consoles on it. I suspect that in the future this central office computer will be preparing bills for the customers while at the same time giving on-line service to the customers. . . .

It would be hard to tell at that time whether the central computer is doing time-sharing or batch processing. We're already doing that with our small computers. We have a program that gathers data from a cyclotron. Between data events we process the data and also do other things. It is processing real-time events and at the same time doing background work which may include a FORTRAN compilation. You can't really identify the nature of the machine any more.

MARSLAND: How much money are we talking about? It appears to me that even five years from now a small university won't be able to afford the cost you must be talking about for a time-sharing system.

HAMMING: Not so. Dartmouth has, at the moment, a GE235 with a disc and they are doing time-sharing.

WEIZENBAUM: In any event, it's a small university with a reasonably small computing installation and they are already doing time-sharing.

Not only that, but many universities are using the MIT time-sharing system. Universities in New England are hooked in to the system through TWX.

McCRACKEN: How long will it be, do you suppose, before we will have 15 computers, each housed in a building the size of The RAND Corp. building, each serving that particular section of the country?

HAMMING: I don't see any prospect of that.

*: It's more probable that you'll have that situation with a hundred installations rather than 15.

WEIZENBAUM: When you're talking about dollars, the proper question is, who are you who is asking about the dollars? The manager of the computing center has one view about dollars; the president of his company has a different one. If you're talking about annual expenditures of a company that can be said to be spent on computation, and it is quite clear to me that in a place like Lockheed the annual expenditures will go down, you can measure this per problem solved or any way you like. People will be used more efficiently and computers will be used more efficiently in the overall sense. Perhaps even total computer time will go down.

The total dollar investment in computer facilities is another thing again. I would refer here to Hamming's principle that says when things change by an order of magnitude, they are different both qualitatively and quantitatively. When we see the price of things like computers or automobiles or airplanes reduced by a factor of 10, then the world has changed. That has been happening with the computer industry and will continue to happen.

WAGNER: I think it would be appropriate here to state a certain number of facts about the economics of the situation. I think we can all agree with these facts if we consider them individually. Correct me if I'm wrong. I've taken most of these from the writings of Hamming.

1. Main frames are going down in cost and there is no reason to believe that the cost of main frames in relation to storage will not continue to go down.

2. Peripheral equipment, in general, is not going down in cost. Anything that can be hung onto the main frame seems to be going down in cost at a much slower rate.

3. Communication lines with a very large bandwidth (that are implied when you talk of a large central computer serving many, many people) are either standing still or going up in cost.

RAMSHAW: Let me interrupt. Quite apart from the

question of cost, I question the assumption that having many remote users implies a high bandwidth.

HAMMING: If you're talking about cathode ray tubes, you will need a high bandwidth. If you're talking about typewriters, no. No matter how you use them, the bandwidth for cathode ray tubes is a lot higher than for a typewriter.

WAGNER: In any event, I don't quite know how to put all this together but I think you can eliminate certain things. For example, any remote system that is going to be very flexible because it communicates by way of cathode ray tubes will have to have short lines to the computer and there can't be too many of them.

GORDON: The expenditures will be diverted from the computer manufacturer to the telephone company.

WAGNER: If there is any way you can figure out how to use main frames and high speed storages in quantities, that looks like it will be the cheapest way to do it.

WEIZENBAUM: What operates to your advantage here is exactly that: you get statistical use of all the expensive things. For example, you have the huge disc unit sitting there—in our case containing half a million words of program alone for compilers and whatnot. But it is shared by so many people, so you can afford to put a lot of money into it. Processors, as you point out, are becoming less expensive. In a time-sharing system, one of the things you would like to have is multiple processors. It looks very favorable, and I am personally convinced that this is the wave of the future. There is really no way of avoiding it.

McCRACKEN: I want a point of information. When will it happen that the cost of the gadget that you have in your living room sitting beside the typewriter will get to be really cheap? I don't know what it is now but it must be quite a bit of money. It doesn't seem to be something you can put in every high school physics classroom today, for example.

HAMMING: Let's be careful. Let me go back to the question that Major Marsland raised. How soon is he going to be able to have remote consoles for his Air Academy students? I would say very soon because of the optimization problem. The cost of having each student in that school is very high. The total computer budget may, in fact, go up for the Air Force but the utilization per student will go up much faster. The efficiency per student will be so much improved that they will find it economically advantageous to get lots of remote consoles scattered all over that installation.

POWELL: I think that an estimate of five years is a real way-out figure. I would be inclined to estimate it much sooner.

McCRACKEN: Do you think that little box is going to get down under \$500?

HAMMING: No, but think what it costs at the Air Force Academy to maintain one cadet.

McCRACKEN: But in the average high school it isn't going to happen at all unless the cost of the gadget gets way down.

HAMMING: It depends on how soon they want to look at the total optimization problem in education. Right now all they look at is the total dollar expenditure for the computing center.

GORDON: How much does a Model 33 [Teletypewriter] cost anyway?

ARMER: Under \$600.

WAGNER: I think that the total cost of each console comes out to less than \$50 a month, for the gadgetry, that is.

WEIZENBAUM: I don't know the actual figure but it's quite cheap as such things go. ■

(Concluding Part 2, next month)

TELEPHONE SWITCHING BY COMPUTER

by Dr. ERNA S. HOOVER

In order to provide for the ever growing demand for present day communications services, as well as for new kinds of services, a new electronic switching system (No. 1 ESS), controlled by a stored program, has been developed for use in the Bell System. As telephone and other switched services grow, switching systems must become more sophisticated and capable of processing more calls. By changing the stored program in the memory of the ESS, new features can easily be added and present features can be changed.

The first installation in Succasunna, N.J., is capable of offering the services familiar to customers, as well as a number of special services. For example, customers will be able to transfer incoming calls to another number when they are away from their telephones. These abilities of the No. 1 ESS are made possible by the use of a stored program to control the orders given to the switching network.

Fig. 1 shows a block diagram of the system. An electronic data processor, or "central control," directed by its stored program, detects the signals which indicate that customers have asked for service, have answered, have hung up, or are dialing. It makes the appropriate logical decisions and sends the commands to the switching network to connect or disconnect the lines involved.

Customers' lines, trunks to other central offices, and circuits needed in the course of processing calls, such as digit detectors, ringing circuits, and busy tone circuits, terminate on the switching network and connect to each other through eight stages of switches. The interconnecting switches consist of ferreeds; small metallic reed relays which open or close according to the magnetic state im-

telemation in succasunna

parted by control windings to an associated bar of magnetic material. In a very large office, up to 80,000 terminals may be interconnected. The circuits terminating on the network are operated by means of a "signal distributor," a device which selects the desired relay from the hundreds to which it has access and delivers a pulse which opens or closes the relay.

The central control functions as the brains of the system, while the signal distributors and network controllers function as the motor nerves, transmitting signals to the



Dr. Hoover supervises a group at Bell Telephone Labs whose responsibility is the systems planning of the data processor, its memories, and the organization of the program for the No. 1 Electronic Switching System. She holds a BA from Wellesley College and a PhD from Yale Univ.

TELEPHONE SWITCHING . . .

appropriate relay circuits, which serve as muscles. By the same analogy, the sensing nerves are the ferrod scanners. The central control can sample the state of line or trunk circuits by addressing a scanner which selects the proper ferrod and interrogates it. A ferrod is a rod made of ferrite material which senses the presence or absence of current flowing in a circuit when the ferrod windings are appropriately pulsed.

In addition to controlling the switching network and its circuits, the central control communicates with human beings by means of teletypewriters. By means of magnetic tape, the basic data used for computing charges on customers' calls are recorded. The central control communicates with the network, scanners, distributors, and other input-output devices by means of a high speed bus system. The orders are sent over the bus system to all units simultaneously. The unit for which a particular order is intended is made ready to receive it by means of an "enable" signal from an electronic pulse distributor.

memories

Controlling a telephone central office requires a large program; in Succasunna it exceeds 100,000 44-bit words. In addition, certain individual facts about the types of service to be accorded to each line and trunk must be provided to the program. These data are stored in "translation" tables, and may exceed 10 million bits in large installations. In order to provide a large, economical random access memory, Bell Laboratories developed a permanent magnet twistor store. Fig. 2 shows a picture of this program store. Each twistor store contains 131,072 44-bit words and gains random access to a word in 5.5 microseconds. At least two such units are used in every installation.

Fig. 1 Central Information Processor with Stored Program (No. 1 ESS)

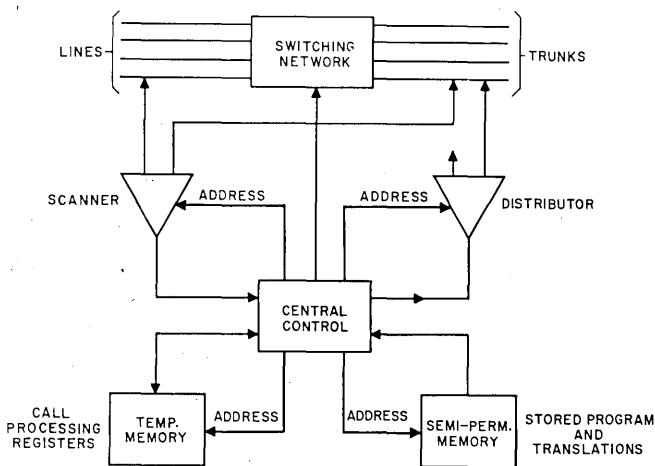

The information in this store is coded on magnetized vicalloy areas on aluminum cards. A permanently magnetized area represents a "zero;" when demagnetized, it represents a "one." When the cards are placed in the twistor module, each little magnetized area appears at the intersection of a copper solenoid loop and a twistor wire. By selecting and pulsing a given solenoid, all the twistor wires which lie between that solenoid and the non-magnetized bar magnets will show an induced voltage in the wire; those wires associated with magnetized bar magnets will not. This "read-only" memory can serve as a storage medium for program and translation data because

neither needs to be changed often. To make changes in each installation, a card writer is provided, which properly magnetizes and demagnetizes the areas on the cards.

Because the program store is a read-only memory, a read-write memory must be provided to store data which changes during call processing. The memory which has been developed for this purpose is made from ferrite sheets, containing a 16 x 16 array of holes. Copper is electroplated in a pattern equivalent to a wire threading 256 holes. The module consists of 8192 words of 23 information bits and 1 parity bit. The ferrite sheet store also meets the general system 5.5-microsecond cycle time for reading and writing. The smallest office will require a pair of such stores, while a large office might use 30.

data processor

With program in one memory, and all the frequently consulted data in another, it is natural to think of designing a data processor, or "central control," which profits from the division. While one instruction is fetched from the read-only memory, the central control obtains data from the temporary memory and performs the logic required by the previous instruction.

Because the memories function so differently, the word size of a program word and a data word differ. In fact, the address field of the program word was made large enough so that a 23-bit constant could be stored there and used directly as data. In a conventional computer where program words and data words are of the same length, data must be specified indirectly by means of an address.

As a part of the planning that preceded detailed design of the central control, several possible order structures were devised. Programmers wrote specimen programs for the tasks which are most usual in such a machine. As a result, the order structure of the central control is well suited to the tasks it must perform. A switching program

Fig. 2 The Program Store, a Semipermanent Twistor Memory Developed for No. 1 ESS

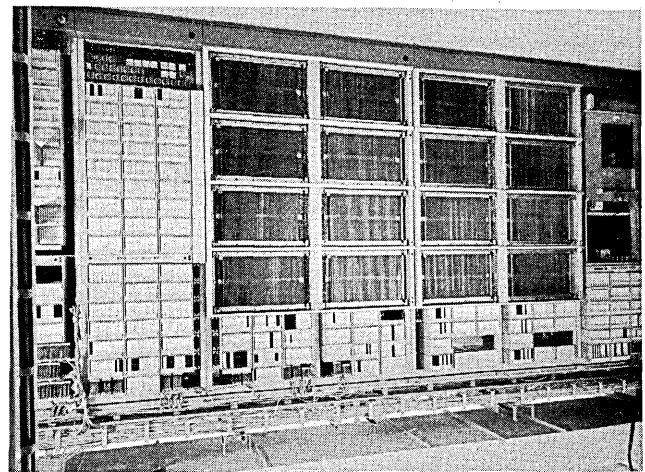

is likely to spend its time in looking up data in tables, selecting and moving data, and performing logical operations. Relatively little arithmetic computation is done. Hence, the central control has instructions for fixed point addition and subtraction but none for multiplication and division. Obviously, a floating point arithmetic unit is not needed, but a wealth of logic instructions are.

For example, since efficient use must be made of temporary memory, extraction and storage of bits in a portion of a word is accomplished quite elegantly. If one wishes to insert four new bits in positions 4-7 of a word in temporary memory leaving unchanged bits 0-3 and 19-22,

one may specify the position of the bits to be changed in the address field of the write instruction. A tag specifies the index register where the address may be found. This instruction is carried out in one machine cycle.

program organization

Just as the hardware was developed to meet the special requirements of controlling a switching network, so the program was organized in a distinctive manner. Unlike a typical computation center in which work is scheduled in job shop fashion, the ESS cannot control the time when it must process calls because telephone customers expect to receive prompt service at any time they choose to call.

The program is organized to share its time among a number of telephone calls. Since the individual actions taken to initiate a call are slow compared with the speed of the data processor, the program picks up a call, does all the work that it can do for that stage of that call, then goes on to process another call. A certain portion of the temporary memory is devoted to storing the salient facts about each call so that other programs will not overwrite them during the time that other programs have control of the machine. Thus a program is able to resume processing correct data when a new action on the part of the customer requires further response from the system. Actions must be taken by the system promptly; failure may mean inordinate delays to customers and, sometimes, misdirected calls.

Fortunately, different degrees of promptness are appropriate to different actions. For example, the system can be sure to detect the sequence of d.c. changes which constitute dialed digits if it samples the state of the customer's line every 11½ milliseconds; on the other hand, the system can adequately distinguish hangups from chance jiggles of the telephone switchhook if it samples the state of the line only once every 100 milliseconds.

Once having determined what sort of signal has come in, the system can afford to take more time before making the chain of logical decisions which determines how to treat the call. Thus, the programs tend to be of two types: one, the periodic, repetitive and somewhat simpler tasks which gather input signals and generate such output as charging information and orders to control the switching network; and the other, the more complicated chain of logical reasoning which can take place at a more leisurely pace. The presence of the second class of programs gives the ESS the ability to offer many new services.

maintenance and administrative programs

Once set to processing telephone traffic, the machine may not be taken out of service for routine maintenance. For unexpected breakdowns, the down time should not exceed a few minutes in the decades of service which the machine is designed to give. As a result, all essential portions of the machine are duplicated.

In normal call processing two sets of processing machinery independently process the traffic; their results are matched at certain critical points. In getting information from memory, redundancy checks are made. Whenever such indicators register a possible trouble, the normal call processing is interrupted, and control of the machine is passed to a "fault check" program. It determines which, if any, of the units has failed, sets up a working configuration of good units, and returns control to the normal processing programs.

At a later time, call processing programs pass control to a diagnostic program which tests the faulty unit to pinpoint the faulty circuit package. A repairman then replaces the package and puts the unit back into service. In addition to such fault check and diagnostic programs,

the system makes routine checks of itself. Like a hypochondriac, it constantly checks the state of its health during lulls in the call processing work. For example, the receiver circuits, which are connected to a line to detect dialed digits, are put through a series of exercises to make sure that they are working.

Many of the test programs make use of program sequences common to the routine call processing programs. A program sequence used in finding a path in the switching networks between a receiver and a regular customer is also used in finding a path between a receiver and a test circuit. Certain input-output routines are also used in common. Maintenance programs provide a means of communication between information produced by the ESS and human beings charged with the responsibility of maintaining it. Other administrative programs make it possible for human beings to collect data on the amount of use of various kinds of equipment. These data are needed to provide sufficient equipment as the central office grows. Still other administrative programs facilitate the routine changes made daily in telephone offices as customers request changes in service.

executive control program

In order to give each program its proper priority, when a particular task is finished, control is always passed to the executive control program. This program assigns the next task to be done. If a five millisecond interval has elapsed since the time that the input-output programs were last entered, a wired interrupt breaks in and transfers control to an intercept program which saves any information present in the flip-flop registers of the data processor, so that it can be recovered later. Then the input-output programs are entered. A schedule in the memory is consulted, and the next input-output task on the list is performed.

Those tasks which must be performed to the closest tolerances, such as the look for dial pulses, are performed first. Those which have a broader tolerance come later in the interval. The looks for answer and hang-up which are needed only every 100 milliseconds are subdivided so that in any given 5-millisecond interval about 1/20 of the terminals are examined. A statistical study of the length of various tasks was used to show that the tolerances would be met. Any input-output required by maintenance or administration programs is worked into the same schedules.

When all the scheduled tasks are finished, the executive control program returns to the specific task which was interrupted. The data originally stored away when the interrupt occurred is put back, so that the interrupted program proceeds without influence by the interruption. When that program is finished, the executive control program assigns the next task. Tasks assigned to the time not used by input-output are of a character that may be postponed for fractions of a second or more without spoiling the call. However, in order to keep the system running as efficiently as possible, these tasks are sorted into classes, according to the relative frequency with which the executive control program assigns control to them.

Typically, the system starts on a job because an input program found a new action which requires a system response. The work found in this manner is stored in memory in buffer areas along with a tag identifying the call. Each kind of input program puts its work in its own set of buffers. These buffers are then assigned a class from A to E. They are visited according to the following repeated pattern:

ABACABADABACABABACABADABACABAE

During a lull in traffic, when there is little call processing to do, the executive control program can look in all the

TELEPHONE SWITCHING . . .

buffers and come full cycle from E to E in a few tens of milliseconds. When the work builds up, the entire time to cycle through the tasks will lengthen, since more work will be found and more time spent processing the tasks in the buffers. The work in A buffers is attended to about twice as frequently as the work in the B buffers and four times as frequently as the work in the C buffers. By judicious assignments, the less frequently visited buffers are those which institute brand new calls and new maintenance and administrative tasks. Thus, calls already in the system will receive prompter treatment than new calls. Most routine maintenance, diagnostic, and administrative procedures are assigned the E classification.

When the data processor has few traffic demands upon it, routine maintenance tests will take a fair share of the total time of the system. Since the maintenance work can generally be divided so that roughly the same time is spent doing maintenance whenever the system comes to it, the proportion of time spent in maintenance becomes less as the system takes longer to complete the cycle. Thus, the executive control program is designed as a flexible system for assigning tasks which can tolerate different amounts of delay in the face of a fluctuating demand.

the generic character of the program

Telephone central offices differ from each other in the types of services their customers may require and in the types of equipment they must control, with the result that some programs are not needed in some installations. Furthermore, the number of electronic switching installations will reach into the thousands in the years to come. In order to simplify programming, compiling, and record keeping, a very few versions of the program will be developed. Each version will contain a set of features sufficient for hundreds of offices. A small fraction of the program sequences may not be needed at the time it is installed in an office.

When the feature is needed, the translation data associated with the lines and trunks affected must be updated. In deciding what service to give, each time the machine processes a call it looks up the pertinent translation. When it finds an appropriately marked line or trunk, it enters the special sequences. Until the translation data are so marked, the sequences will not be entered.

storage allocation

Because the machine must share its time among many calls, storage in temporary memory is allocated so that data needed by the programs to process certain calls are left intact while other programs are in control of the machine. In this sense, the ESS resembles a multiprogrammed computer, where the data from various jobs are kept in core simultaneously, more than it does the conventional job shop machine in which storage is cleared between jobs.

Working storage is not treated as one massive pool of available space but rather is assigned to particular functions according to the traffic characteristics of the given telephone central office. For example, a given block of 17 words of memory is assigned to each call during dialing. As the digits of a call are detected one by one, they are stored in such a block until the program is able to determine that the end-of-dialing has been reached.

In any given telephone office enough blocks of memory are provided so that the number of people wishing to dial simultaneously in the busiest hour of the day can normally be accommodated without delay. This number is arrived at in each central office by observing the behavior of

customers in that office. On the rare occasion that a customer's call arrives during a time when all dialing blocks are in use, a code identifying the call is placed in a queue, which is served in the order of first come, first served. Sometime before the call progresses to the talking phase, the block of memory used for dialing is released so that another call can use it.

If the dialed call must be charged, another block of memory for storing the details needed for proper charging is seized and is held until all items are collected. For calls which are timed, this is for the duration of the call. These blocks of memory are also provided according to the telephone habits of the customers served by the particular central office.

This method of storage allocation has three advantages. First, a sufficient amount of storage is provided to insure the desired grade of service for each of the necessary telephone functions. Second, the sizes of memory blocks are tailored to the needed function, thus saving storage. Finally, since the program is divided into functional blocks a given program generally needs to know the format of only a few areas of storage.

parameter treatment

Different central offices vary in the quantities of memory and hardware needed. A given central office will use different amounts as the office grows. It is desirable to keep the basic program intact through such changes to avoid compilation costs and the risk of introducing errors in the program. The data used to designate the local quantities are not built into the program, but are organized in tables in a given area of the memory known as the parameter section. When a change is made in storage allocations, the parameter section is recomputed and changed. Program recompilation occurs only when new program sequences are added.

Where possible, programming algorithms are used which are not affected by the particular quantities of equipment. For example, as mentioned above, the number of blocks of memory devoted to dialing and the number of blocks devoted to charging vary from central office to central office. When a call reaches the point where a block of either type is needed, the program consults an appropriate heading cell containing the address of an idle block of memory or a code indicating that all blocks are in use. In the latter case, no more searching is required. In the former, the idle block itself contains the address of another idle block which is placed in turn in the heading cell before using the first idle block found. This application of a link listing technique requires that new members be added to the list when the storage allocation is changed. However, during normal call processing, the program does not care whether there are a possible 300 idle memory blocks of a given type or whether there are three. Both quantities might be found in certain central offices.

The time-shared character of the processing, the need to provide memory for specific functions arising from the unscheduled demands of the customer, and the need to accommodate central offices which differ in amounts of equipment and which grow over a period of time all affected the manner in which storage is allocated.

Thus, in software and hardware the ESS is designed to render both familiar and new services to the standards of economy and reliability we have come to expect of our telephone system. The local telephone central office is the first application. With proper modifications of the program and hardware, data services, toll switching, government and military services can be offered by this system. ■

A detailed account of the No. 1 ESS is given in the *Bell System Technical Journal*, September 1964.

CIRCLE 20 ON READER CARD →

DATAMATION

CHOOSING A SET OF COMPUTERS

with care

by ALAN C. BROMLEY

We have recently completed a study at North American Aviation, Inc. (hereafter referred to as NAA or North American) to decide what should be the next major step in computing equipment for the entire corporation. This is a description of the process we went through to arrive at our recommendation.

The total computing hardware study was divided into two parts which were conducted one after another by two committees. The committees (both chaired by Willard Olsen, programming manager at the general offices of NAA) consisted of about 10 members each, most of whom worked on both parts of the study. Committee members were computer-oriented specialists representing several operating divisions and the corporate offices and several disciplines (engineering, management of computer operations, computer programming, and management systems). There were no constraints placed on us either by the organizations we represented or by the corporation. It was our responsibility to come up with whatever computer hardware recommendation would, in our opinion, be best for North American. I believe the study was completely successful in achieving this objective.

The first part of the study resulted in the preparation of a proprietary guide to computer evaluation. It was called the "Wares Guide" because it covered hardware, software, and "people-ware"—i.e., support personnel. During this part of the study, we hired an outside consultant

To place in perspective the environment in which this selection process took place, it should be noted that the two-shift rental for computers being paid by NAA is reputed to be almost \$50 million a year. The company, however, places it at \$15-20 million.

whom we consider to be an expert in the computer field. His assistance was invaluable.

The Wares Guide consists of descriptions of items of concern when making a computer evaluation and explanations of the importance of many of the less obvious items. I won't list all of the information we considered important, but the chapter headings will give some indication of the contents: Supplier's Status and Reputation, Contract Terms, Delivery Schedules, Support, Families, Hardware, Software, Conversion, Bench Mark Guide Lines, Operational Aspects, and Physical Planning. Items were con-



Currently with the Harvard Computing Center, Mr. Bromley had been with NAA's Los Angeles Div., where he was engaged in long-range planning of computer applications and equipment. He was most recently a member of a special study group that recommended dp equipment, organization, and policies for the entire corporation. He holds a bachelors in industrial engineering and business administration from the U. of Minnesota.

CHOOSING A SET . . .

sidered independent of the ease of getting information. Our objective was to define what we would like to know about computer offerings.

One important benefit of the first part of the study was that we thought about and discussed the multitude of considerations required for good computer evaluation.

Because of the highly volatile nature of the aerospace business, we felt that it would be wiser to decide only on the basic computers or computer families in such a corporate-wide study and leave decisions as to precise equipment configurations to the six operating divisions which make up the corporation.

more and more

North American Aviation already has several large computer installations. By extrapolating from history, we expect to see a continual increase in the demand for computer capacity. We don't know what effect remote computing and real-time business processing will have on our computing load nor do we know exactly what the workload at NAA will be in the future. But, remember, we saw our objective as choosing a computer family or families, not a particular configuration.

We felt that we could arrive at a recommendation knowing only that North American's computing load would be somewhere between 70% of the current load and two or three times the current load. Configurations ordered now will be quite different from what we will actually have in two or three years. The objective of our study was to decide what direction to go by choosing the principal suppliers for replacement of North American's present data processing equipment.

So much for the overall objective and the first part of the study. Armed with a guide full of items to consider and an abundance of ideas, we set off towards our goal, a concrete recommendation.

the next step

The second committee's effort consisted of digging out facts, plans, and opinions about the various suppliers and their wares by studying manuals, contacting suppliers' representatives, visiting other computer installations in the aerospace industry, evaluating the significance of what had been learned, and discussing these matters at great length.

The committee looked at computers and computer suppliers in a number of different ways. One exercise we went through resulted in numerical scores for each alternative being considered. The technique we used provided us with an organized method of relating the detailed attributes of individual computer suppliers and their offerings to the general goals of NAA management. It was particularly valuable in helping us take into account those management goals which sometimes conflict with each other, such as economy and responsiveness.

The following discussion will describe our scoring method because I think it is interesting and useful. The resulting scores were consistent with the outcome of less formal, traditional, deliberative processes (thinking and talking).

First, we defined goals of NAA management which are affected by the use of computers. Each of the goals was subjectively weighted as to its current importance relative to the other goals in such a way that the total of the weights of all the goals added up to 1. Five goals were used in our particular evaluation. The weights shown are intended as an example, and were one of several sets we actually tried.

I. Increase employee productivity	.20
II. Improve the availability, relevance, and timeliness of information used by administrators at all levels (management visibility)	.25
III. Reduce current and future corporate operating costs	.20
IV. Improve company's responsiveness	.25
V. Maximize capacity to cope with change (flexibility)	.10
TOTAL	1.00

Then, the characteristics of the NAA data processing activity were described, which we felt supported the NAA management goals listed above. Explanations were written describing how each of the data processing characteristics supported each of the goals. The characteristics were then rated subjectively as to their relative contribution to the accomplishment of each of the goals so that the total of the ratings of all of the characteristics in supporting any one goal was 1. Six characteristics were used in the actual evaluation. They are listed here, with one of the several sets of ratings we used, to illustrate the methodology.

CHARACTERISTICS	GOALS				
	Employee Productivity	Management Visibility	Low Company Costs	Company Responsiveness	Flexibility
1. Low data processing costs	.20	.20	.30	.10	.15
2. Interchangeability of jobs, files, and programs among company's computer installations	.10	.25	.25	.25	.30
3. Strong capability to exploit technological advances	.25	.30	.10	.30	.05
4. Adaptability to changes in applications, workload, centralization or decentralization	.10	.05	.10	.05	.40
5. Minimal risks in implementing and operating system	.15	.10	.15	.10	.05
6. Extensive, responsive, and effective support by supplier	.20	.10	.10	.20	.05

We then calculated a relative weight for *each characteristic* by summing up, for each, the products of the characteristic contribution to each goal multiplied by the weight of the goal.

Thus, desired characteristic #1, "low data processing costs," has a weight of $(.20 \times .20) + (.20 \times .25) + (.30 \times .20) + (.10 \times .25) + (.15 \times .10) = .19$.

Likewise, the other characteristics can be computed, resulting in:

	Calculated Weights
1. Low data processing costs	.19
2. Interchangeability	.22
3. Capability to exploit technological advances	.22
4. Adaptability	.11
5. Low risk	.12
6. Good support from supplier	.14
TOTAL (only important as a check for computation errors)	1.00

The computer processing needs of NAA might conceivably be satisfied in a number of ways. Several possibilities were considered and eliminated because it was felt that they would not meet NAA's overall requirements

How to make a fast getaway from a 1401

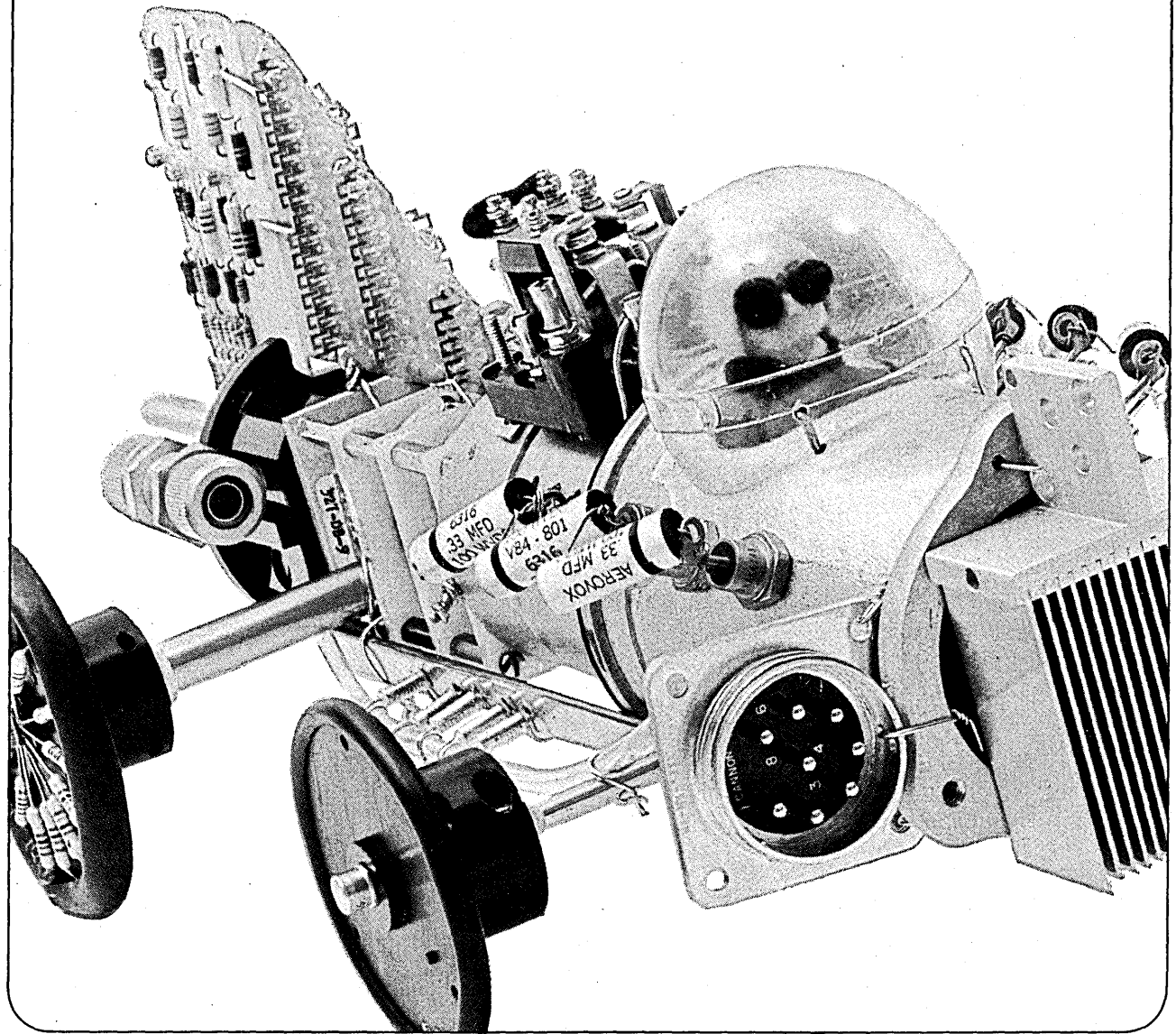

You've been using a 1401 computer.
Now you'd like to step up your capacity.
Accelerate your sorting.
Cut your costs.
Get all the horsepower and economy of a new-generation computer.
If only you could do these things without reprogramming. You can.
Because we built Honeywell Series 200 with you in mind.
Your present tapes will run

without change on a Series 200 computer. Our Liberator will turn your present programs into fast-moving new programs — automatically and permanently. (That other new system runs old programs in low gear. And you have to stop and shift to run a new program.)

You'll process more data faster than ever with Series 200. It will, for example, sort up to five times faster than a 1401. You can write new programs without having to learn a whole new language, and you'll have the most efficient COBOL and

FORTRAN compilers in the industry.
What will it cost? Less than you'd pay for a comparable configuration from any other manufacturer. And it's loaded with extras.
You can see one at any Honeywell EDP showroom.

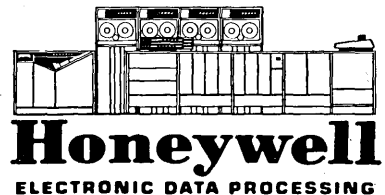

Honeywell
ELECTRONIC DATA PROCESSING

CHOOSING A SET . . .

as described by the goals and characteristics outlined above. These alternatives included separate, incompatible scientific and business systems and a completely centralized installation for use by the whole company.

sifting details

Using the characteristic weights calculated (in the same way that we went from management goals to data processing characteristics), we went down another level to detailed attributes of computer suppliers and their wares, which we thought provided a means of comparing suppliers' abilities to fit into an NAA data processing operation which would possess the characteristics described above. In order to reduce the "Wares Guide" (remember, that was the output of an earlier committee in our study) into a more manageable list of items, we combined and eliminated until we arrived at a list of 41 attributes which included such items as past pioneering efforts, contract terms, compatibility, of offerings, programming ease, expected heavy compute performance, and expected heavy character-manipulation performance. Each of the attributes was rated subjectively according to its relative importance to the achievement of the characteristics desired.

The complete list of attributes and their ratings are not given here because they would not be useful without rather lengthy descriptions or unless placed in the context of the study group and its deliberations. Again, following the same sort of rule used previously, the total of the ratings of all the attributes in supporting any particular characteristic was 1. Many of the spaces in the matrix were zero because some attributes seemed to us to have no

bearing on the achievement of a particular characteristic. Computing attribute weights was accomplished in a procedure identical to that used in calculating characteristic weights—that is, by summing up, for each attribute, the products of the attribute importance in achieving each characteristic, multiplied by the characteristic weight.

Thus, we arrived at a weight for each of the 41 attributes. We had already narrowed the alternatives being considered down to four computer families. Each of the four families was then rated relative to the others for each of the attributes using the same rule as before—i.e., the total ratings of all suppliers relative to a particular attribute must equal 1. Finally, performing the same multiplying and adding of ratings done previously, we arrived at relative scores for each of the computer suppliers being considered.

Because the sheer computational mechanics became burdensome, a computer program was developed for a desk-size computer, the Recomp, that shortened this otherwise time-consuming part of the process.

The entire study was heavily oriented towards relating the offerings of computer suppliers to the goals of NAA management and, therefore, these particular lists of goals and characteristics may not be significant to someone else. Since we felt least qualified to decide on correct weights for the management goals, we were especially concerned with the sensitivity of the end scores to changes in goal weightings. This problem was approached by assigning one goal a weight of 1 and the other goals 0 weights, and then seeing how much the resulting supplier scores were affected. In this way, we went through a series of complete re-calculations with each goal, in turn, made artificially all important. We found that the supplier scores were almost completely insensitive to even severe changes in goal weights. Similarly, we looked at the sensitivity of the individual attribute weights to change in goal weights, and we studied the effect of using different supplier ratings for particular attributes.

the limitations

Of course, this approach should never be considered as a substitute for sensible decision-making. It has certain inherent limitations. For instance, there is no way of describing items which completely rule out consideration of an alternative. As an example, a price completely out-of-line could result in no less than a 0 weighting for a particular supplier for only one attribute. In fact, such a price may completely eliminate the supplier from serious consideration. And, of course, the results have no more reliability than the weights assigned throughout.

But given such limitations, the scheme proved to be of considerable use. It provided a good framework in which to organize, present, and discuss ideas and opinions. And, just as with other modeling techniques, it caused us to methodically think through many interrelating details which we might not otherwise have considered properly.

The basic idea for this weighting scheme came from two articles in *Aviation Week* and *Space Technology* (the issues of December 28, 1964, and January 4, 1965) describing a system which Honeywell used to evaluate the relative potential importance of alternative research projects by relating the projects to national goals. We are also aware that this or similar techniques have been used by others.

I have no reluctance to recommend the overall process we followed to any company faced with a similar decision. It was an organized approach, permitting consideration of one subject at a time, and proved successful in removing most of the pre-conceived ill-founded biases of committee members. ■

THE CORRECT ANSWER

VISirecord

VISIBLE CONTROL EQUIPMENT

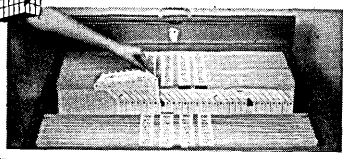

Whether automated or handwritten, whatever the record, VISirecord Systems and Systems Specialists are available with the right answer. The offsetting of cards in VISirecord provides "One Motion Selectivity" unequalled for finding and filing speed. VISirecord housings will handle any size card, with top efficiency. Equipment economically tailored to suit your requirements.

"AUTOMATIC VEE" TRAYS

Another outstanding example of a VISirecord aid to automation, these trays are standard for 13 different cards sizes including the paper tape file illustrated. Tables or enclosed housings are also available.

The world's fastest record keeping system.

VISirecord, Inc.
Copiague, Long Island, New York

Please send me additional information on your record keeping systems, without obligation.

Name

Address

Firm Phone

THE MARGINAL UTILITY OF INFORMATION

controlling the output

by DONALD V. ETZ

■ Marginal utility is a well-known concept among economists. Briefly, it is the value (utility) to a consumer of each additional (marginal) unit of an economic good. This value (utility) is presumably definable in monetary terms as the price the consumer is willing to pay for each additional (marginal) unit.¹

For example, if the economic good is a pair of shoes of a given style, size, color, quality, and brand, and a consumer owning three pairs of shoes having these characteristics is willing to pay \$1 for a fourth pair, then an economist would say that the marginal utility of the fourth pair of these shoes for this consumer is \$1.

It would be helpful to the producers of information and information systems to apply the concept of marginal utility to the economic goods they hope to market. This paper is intended to review a few important facts of economic life which develop from this concept, and to apply them to the economy of information.

Ordinarily, the marginal utility of a good is inversely proportional to the quantity possessed. That is, the greater the quantity of a good in your possession, the less you are willing to pay for an additional unit of that good. You might be willing to pay \$25 for the first pair of shoes of given characteristics, but only \$15 for a second pair, \$5 for a third, etc. The marginal utility of these shoes is a decreasing function of the number in your possession.

Ultimately, the point is reached at which the consumer is willing to pay nothing for an additional unit of the good. If our hypothetical shoe fancier is willing to pay nothing for a fifth pair of shoes, then the marginal utility to him of the fifth pair is zero.

The cumulative marginal utilities of a good for all possible consumers determine the total quantity demanded

of that good, at any given price. Hence, the total demand curve for the good is a function of all individual marginal utilities. For example, if there are three prospective customers (A, B, and C) for our hypothetical shoes, and their individual marginal utilities for the relevant ordinal pairs of these shoes are as shown in the first table in Fig. 1, then the total quantity demanded at each of several representative prices will be as shown in the second table.

Normally, a demand curve will resemble that shown in Fig. 2, illustrating a continuous price-quantity demanded relationship. When price is high, quantity demanded is low, and as price decreases, quantity demanded increases.

Note that the normal demand curve is not a straight



Lead writer for the Engineering Publications Group of the National Cash Register Co., Dayton, Ohio, Mr. Etz is also a senior member of the Society of Technical Writers and Publishers. His articles have appeared in *Public Administration Review*, *Management Review*, and *Engineering Graphics*. He holds a bachelor's degree from Wilmington College, Wilmington, Ohio.

¹Leftwich, Richard H., *The Price System and Resource Allocation*, Revised, Holt, Rinehart and Winston, New York, 1960, pp. 51-53.

MARGINAL UTILITY . . .

line. As price drops, quantity demanded increases rapidly at first. Gradually, however, saturation approaches—a given reduction in price increases the quantity demanded

Fig. 1 Hypothetical Demand Schedule.

Ordinal Unit	Consumers' A	Marginal Utility B	Utility C	Price	Quantity Demanded
1st Pair	\$30	\$27	\$25	\$5	9
2nd	25	25	10	10	9
3rd	20	22	0	15	8
4th	15	0	0	20	7
5th	2	0	0	25	5
				30	1

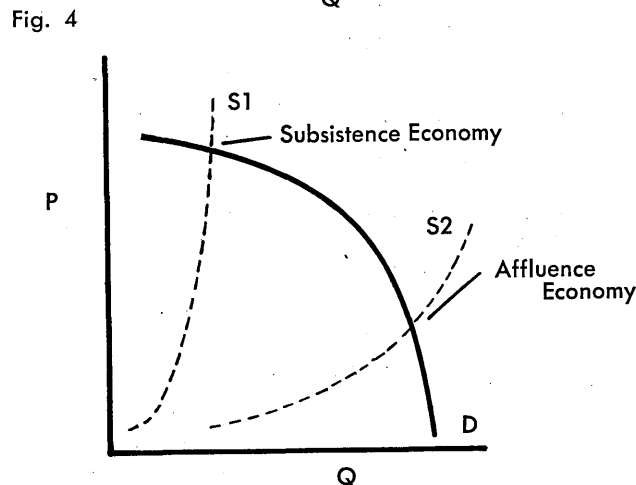
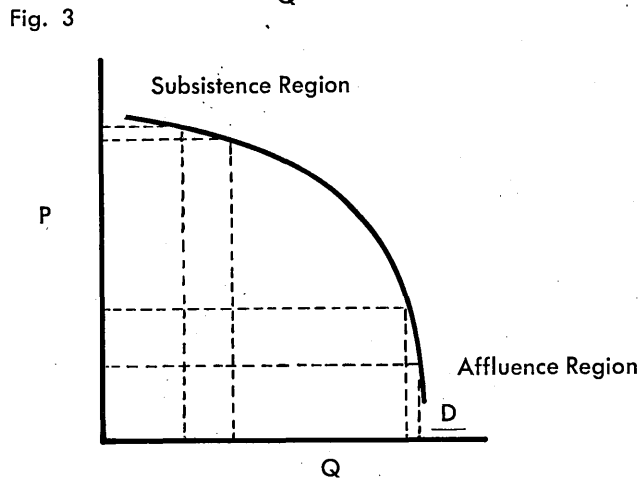
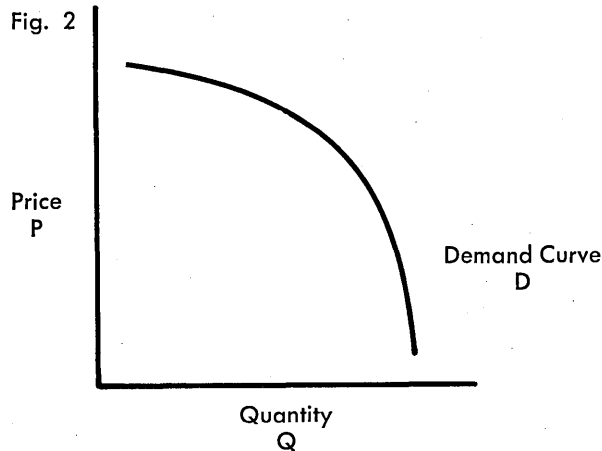

less and less. Ultimately, regardless of further reduction in price, quantity demanded does not appreciably increase. Consumers can find use for only so many units of the good, at any price. The limits on quantity demanded are thus a price so high no one can afford the good, and a demand so satiated the suppliers can't give more away.

We may call that portion of the demand curve in which small changes in price effect large changes in quantity demanded the *subsistence region* of the curve (see Fig. 3). Here, demand for the good is strong (unsatisfied), and consumers may be considered to be at a subsistence level in respect to this particular good. That is, most consumers are not in a position to choose alternatives to this economic good, but will accept readily as much of it as the state of their finances will permit. Its marginal utility for them is high.

At the other extreme, we may call that portion of the curve in which large changes in price effect only small changes in quantity demanded the *affluence region*. Here, demand for the good is weak (satisfied), and consumers may be considered to be affluent with respect to this particular good. That is, they will readily choose alternative goods. The marginal utility of additional units of the good for most consumers is low.

In a given economy, or market situation, a supply curve is also developed, which shows the quantity of the good which its producers will make available at each possible price. Normally, the supply curve intersects the demand curve, the point of intersection indicating the market equilibrium price and quantity exchanged. If the supply curve intersects the demand curve in the subsistence region of the latter, the economy represented by their intersection may be called a *subsistence economy*. If it intersects the demand curve in the affluence region, the economy may be called an *affluence economy* (see Fig. 4).

The concept of marginal utility is an important consideration only in an economy so plentifully supplied with goods that the acquisition of multiple units of a given good and a choice among different goods are real possibilities for a large proportion of consumers. In short, marginal utility is really important only in an affluence economy. Among people who are poor, who never have enough of anything, the concept is far less meaningful. For them, the marginal utility of essential goods remains high over the relevant range of supply, while that of non-essentials is irrelevant.

Is there a marginal utility of information?

The concept of marginal utility applies to all economic goods. An economic good is defined as an item which (1) has utility (the power to satisfy human wants) and (2) is scarce (not freely available to everyone). This definition certainly applies to information. Hence, information is an economic good, and the concept of marginal utility applies to it.

Is the marginal utility of information, as of most economic goods, a decreasing function of quantity? And does the information demand curve resemble that of Fig. 2?

These questions are more difficult to answer. Consider the family as an example.

The family must keep some records of income and certain types of expenditures for income tax purposes. Failure to do so will lead to trouble with the United States government, perhaps to fines or imprisonment. The family is also wise to maintain some kind of budget to control expenditures. Otherwise, it may spend money unwisely and be unable to purchase items when they are needed. In such situations, the utility of the financial information involved is clearly greater than the cost of obtain-

²Bell, John Frederick, *A History of Economic Thought*, Ronald Press, New York, 1953. See Part V, "The Development of Marginal Utility

Economics," pp. 397-480.

ing and maintaining that information.

However, would the average family derive benefit from detailed capital goods accounts, depreciation schedules, periodical balance sheets and income statements, etc., which would justify the expenditure of time and money necessary to develop and maintain such records? It is not at all likely. The marginal utility of this additional financial information is clearly less than the cost of obtaining it.

What is true of families in this case is also true, on a larger scale, of business firms and governments. There is no doubt that the greater the amount of information available, the more rational the decision which can be made. But there is also no doubt that the payoff for greater and greater amounts of information does not always exceed the cost of this information. There are at least two reasons for this. First, one can become saturated with information, unable to assimilate and correlate it to develop any useful predictions or decisions. Second, even if one is able to assimilate all the information available on a subject, the cost of increasing the input information on that subject from, say, 90% to 100% may far outweigh the benefits to be derived from the additional accuracy of prediction or decision.

Why has the marginal utility of information not been widely discussed hitherto? To answer this question, let us briefly consider the origin of the marginal utility concept among economists.

Among Western economic theorists, the marginal utility of economic goods was not at first seriously considered. Classical economics in the eighteenth century, the theoretical foundation for modern economic doctrine, did not even discuss the subject. For men like Adam Smith, Jeremy Bentham, David Ricardo, and John Stuart Mill, the value of a commodity was determined almost exclusively by its cost of production. Not until the mid-nineteenth century did men like Herman Gossen, William Stanley Jevons, Karl Menger, and Leon Walras begin to develop the concept of marginal utility into an important tool of economic analysis.²

Why was this so? The difference in attitude between the two centuries is not entirely attributable to a purely logical development of concepts over time. Rather, we must look to the difference in economic conditions between 1750 and 1850 to find the reasons for this difference in theoretical viewpoint.

In 1750, Europe was just emerging from a subsistence economy in which overproduction and limited markets were minor considerations. Uppermost was the desire for more goods at lower prices. Therefore, the Classical economists, while acknowledging in principle the interaction of supply and demand, devoted their detailed analysis almost exclusively to the supply side. Demand was there, plenty of it. Why then be concerned with marginal utility?

After 1850, on the other hand, Europe was approaching an affluence economy, in which the consumer's choice among alternative goods played an important part. Hence, such theorists as the Austrian school and the Lausanne economists began to examine the demand side of economics closely, and to state with increasing precision the marginal utility concepts which today are universally accepted.

These have been two stages of modern economic theory: first, in a subsistence economy, a single-minded preoccupation with the supply of more and more goods in general, and second, in an affluence economy, a concern

for the value to the consumer of each item in particular.

Until the decade of the 1950's, there existed a subsistence economy for information as an economic good. Mankind has always been poor in information. Hence, the marginal utility of essential information has remained high over the relevant range of quantities demanded, while that of non-essential information has been irrelevant. Uppermost in the minds of men, especially of managers, has been a desire for more information at lower prices. Therefore, information theorists have devoted their detailed analysis to the supply of information. Analysis of the demand for information has been almost nonexistent. Even in the last 20 years, with the high production of information generating an "information explosion," the problems of information distribution have kept attention focused on supply rather than demand.

In a 1961 Industrial Education Institute brochure on "Storing, Retrieving, and Correlating Information and Technical Data," the evaluation of information system utility is given only passing consideration. Speaking of the cost and benefits of information systems, the author notes that costs are relatively easy to calculate, while benefits are "more difficult to calculate because most of the benefits are intangible. . ." He suggests the use of before and after questionnaires directed at users of the information system's output to evaluate its benefits. But all this doesn't really matter, anyway.

Although these measuring techniques are not exact usually, the potential benefits are so much greater than the cost that there is no doubt that an information or data system will yield a satisfactory return on investment.³

The day of a great awakening approaches, however. EDP has made possible the mass production and distribution of information, the emergence of an affluence economy for information. With so much of it readily available, it is only reasonable to expect that information consumers will begin to compare more closely the cost and benefit of acquiring additional amounts.⁴ They will, in other words, begin to evaluate its marginal utility. They will refuse to pay for more information than they can profitably use.

One large business firm has already made a name for itself by undertaking, a few years ago, to see how little information it really needs to operate profitably. Sir Simon Marks, late head of the prosperous British retail chain of Marks and Spencer, began in 1957 to cut out unnecessary paperwork. *Time* magazine called it "The Paper Purge," and *U. S. News and World Report* observed in astonishment, "This Firm Threw Its Files Away."⁵

The danger for information producers arises from a fallacy in their economic assumptions, as illustrated in Fig. 5. Producers tend to assume that the information demand curve is a gradually sloping straight line (D_{expected}).

Hence, as the information supply curve is altered by the transition from a subsistence ($S_{\text{subsistence}}$) to an affluence

($S_{\text{affluence}}$) economy, they expect the quantity demanded to rise markedly (Q_S to O_A), and the price to fall only moderately (P_S to P_A).

Unfortunately, the actual demand curve (D_{actual}) is more probably concave toward the origin, in the fashion

³"Storing, Retrieving, and Correlating Information and Technical Data," an IEI abstract prepared by Freeman H. Dyke Jr., Industrial Education Institute, Boston, 1961, pg. 2.

⁴A warning against people who are preoccupied with turning out masses of data via computer was given in *Navy Management Review*, March 1964. See "A New Breed: Info-Maniacs," pg. 3. A more recent warning is given by Gary R. Martins, "Some Comments on Information Retrieval," *Datamation*, Dec. 1964, pp. 24-27. One sentence in the

article is especially pertinent: "The speed can be bought, like the remote consoles, but only when the customer can be persuaded that the rapid and convenient stuff he gets is worth more than its cost."

⁵See the following: "The Paper Purge," *Time*, Jan. 13, 1961, pg. 76; "This Firm Threw Its Files Away," *U.S. News and World Report*, July 29, 1963, pg. 69; and "British trailer Who Tells Manufacturer How," *Business Week*, Sept. 22, 1962, pp. 114-115ff. See esp. pg. 118.

MARGINAL UTILITY . . .

of typical demand curves (see also Fig. 2). Hence, as the information supply is altered, the actual quantity demanded will increase, but not as drastically as expected (Q_S to O_A), while the price will be driven down much more rapidly (P_S to P_A). And, as an intermediate supply curve (S_I) shows, the quantity demanded will increase most rapidly in the earlier stages of supply

Fig. 5

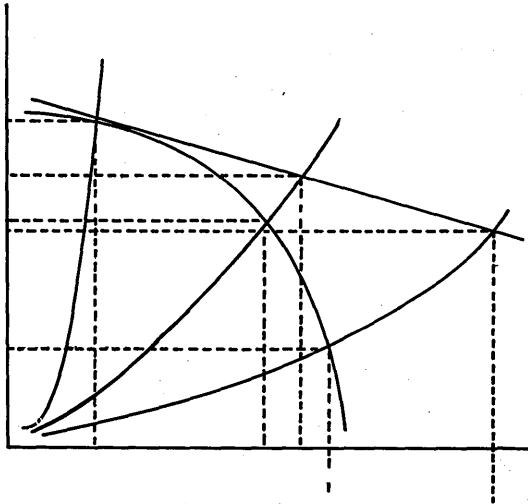

improvement (Q_S to $Q_{I_{act}}$, vs $Q_{I_{act}}$ to $Q_{A_{act}}$). This early growth may lull suppliers into a false sense of confidence in the straight line demand curve, a belief that demand for information is virtually limitless.

It is imperative that producers of information begin now to consider these concepts, to examine more closely the marginal utility of information.

Consider the EDP field, for example. At one time it may have been enough to announce, "I have a computer for sale," to have immediately a backlog of orders. But this phase soon passed, as real competition entered the picture. NCR was among the first to recognize the need to offer data processing systems, not mere computing hardware. But even this phase has nearly run its course. It is no longer enough to promise, "My system will provide you with hourly reports on your business, broken down by every permutation and combination of information category—and do it at less cost than my competitor's system." The manager, facing a growing mountain of paperwork, may well reply as did the woman with 10 children to the readership surveyor: "Who reads?" Specifically, his questions may be: "Will I be able to assimilate and use all the information your system offers me? Will the decisions I am able to base on your EDP system's information be sufficiently more profitable than those I am now making, without the benefit of this information, to justify the cost of your system?"

Today, information producers, from technical writers to EDP equipment manufacturers, must begin preparing themselves for tomorrow's higher order of competition. They must be able to say to a prospective customer, in effect: "I offer you the tools for making more profitable decisions." And they must be able to prove their claims. ■

WESCON '65

task force sessions

They're trying something different at this year's Western Electronic Show and Convention, which will be held from Aug. 24-27 at the San Francisco Cow Palace. Twenty sessions have been organized by task forces. One of the more interesting outcomes is a session, Computer-Controlled Industrial Systems. In this session, on Friday, a single industrial process is used to illustrate the application of three different computer systems.

Following an introduction to computer control and the analysis and model of the specific process—a distillation column—there will be papers on analog, digital, and hybrid control systems for the column. The session closes with a comparison of possible computer control systems and requirements for the future. That session was organized by the Univ. of Santa Clara and Electronic Associates Inc.

A Honeywell-organized session on Tuesday is A Militarized, High-Speed, General Purpose, Parallel Computer. Papers cover the basic concept, logical organization of the processor, memory design, circuit design, packaging, and application & software.

On Thursday, still another task force looks at various facets of the Spectra 70. This takes three papers, followed by a look at memories in present and future generations of computers, and at optical character readers.

A similar group from Ampex, on Friday, looks at Advanced Techniques in Memory Design, and a Texas Instruments team on Thursday examines integrated circuits.

Two general sessions of note: Computer-Aided Engineering Design, on Wednesday, covers computer-aided drafting techniques and electronic design, text manipulation and design planning, and on-line computation for engineering problems. On Friday, a session Computer-Controlled Systems looks at information retrieval, computer-based instruction, time-shared systems in hospitals, and the present & future of process control systems.

This is where we came in. ■

show hours at the cow palace

Tuesday, Aug. 24	9:30-6:30
Wednesday, Aug. 25	9:30-9:30
Thursday, Aug. 26	9:30-9:30
Friday, Aug. 27	9:30-6:30

ACM NATIONAL CONFERENCE

august 24-26

The local utility company used to advertise Cleveland, Ohio, as "the best location in the nation." Someone bought it. For the Assn. for Computing Machinery, in its 18th year, is holding its 20th national conference at the Sheraton-Cleveland, Aug. 24-26.

Scheduled are 16 technical sessions, with 47 papers, plus seven panel discussions. One of these, on recent developments in time-sharing, will be the only scheduled night session. While we dislike evening programs, there's really nothing else to do in that town.

Advance registration fee for members is \$12; at the conference, it's \$15. Nonmembers will be assessed \$30 with the option of applying the difference between thirty bucks and a member's fee toward a first year's membership in the ACM. The registration desk opens at 6 p.m. on Monday, the day before the conference convenes, and will be in business during conference hours. To accommodate the sociables, three rooms on the Parlor Floor will be open to conference registrants from 6 p.m. to 1:30 a.m. on Tuesday and Wednesday. These will feature assorted potables (\$1 per drink) and light snacks. Bring money.

Notebooks and a fist full of pencils are more in order, however, for those attending the panel discussions, the transcripts of which will not appear in the proceedings. The latter, with full texts of the technical papers, will be distributed at the registration desk.

Topics to be discussed by panelists are Computer Aids to the Handicapped, Next Step in Programming Languages, Time-Sharing Hardware & Software, Uses of Real-Time Scope Systems, Legal Responsibilities of Computer People, Design of Large Programs, and Graduate Programs in Computer Science.

An abbreviated list of exhibitors includes AT&T, CDC, DEC, GE, and IBM. Also add California Computer Products, Teletype Corp., and Prentice-Hall Inc.

Because the meeting and its exhibit does not compare in size to the Joint Computer Conferences or the DPMA International, it affords an excellent chance to meet people engaged in research and wrestling with workaday problems. In its casual setting, the ACM National is one of the best conferences for the exchange of ideas. And that's the purpose.

THE TECHNICAL PROGRAM

Tuesday, 9 to 10:30, Grand Ballroom North

Recent Study of Teaching
L. R. Turner, Chairman
NASA — Lewis Research Center
Cleveland, Ohio

Machine Aids In Rehabilitation
M. L. TAYLOR, G. ROSE and
M. A. WOODBURY
New York Univ., New York, N. Y.

E. S. FERGUSON
Rockford Research Inst., Inc., Cambridge, Mass.
Experimental Cybernetic Foundations of Learning Science
K. U. SMITH
Univ. of Wisconsin, Madison, Wisc.

Tuesday, 9 to 10:30, Gold Room

Evaluation and Performance of Computers
R. F. Hitti, Chairman
Standard Oil Co. (Ohio)
Cleveland, Ohio

Application Benchmarks: Key to Meaningful Computer Evaluations
E. O. JOSLIN
EDP Equipment Office, USAF, Hanscom Field, Bedford, Mass.
TrafficSim: A Design/Evaluation Tool
P. A. ROTA and J. H. DEPUYT JR.

Data and Information Systems Div., ITT, Paramus, N. J.

Interaction of Hardware and Software Parameters in Tape Operations
W. B. EDWARDS JR.

Peripheral Equipment Div., Control Data Corp., Minneapolis, Minn.

The Program Monitor: A Device for Program Performance Measurement
C. T. APPLE

Systems Development Div., IBM, Poughkeepsie, N. Y.

Tuesday, 11 to 12:30, Grand Ballroom North

Panel Discussion
Computer Aids to the Handicapped
E. L. Glaser, Chairman
Project MAC, MIT, Cambridge, Mass.

C. MOOERS
Rockford Research Institute, Inc.
D. M. B. BAUMANN
Dept. of Mechanical Engineering, MIT
M. WOODBURY
Data Processing and Computation Lab., N. Y. U.
E. AVAKIAN
Teleregister Corp.

Complex Information Processing
M. M. Stone, Chairman
Consultant

Sherman Oaks, Calif.

A Language for Class Description and Its Processor

E. C. MILLIKEN
Case Inst. of Technology, Cleveland, Ohio

A File Structure for the Complex, the Indeterminate, and the Changing

T. H. NELSON
Dept. of Economics/Sociology/Anthropology, Vassar College, Poughkeepsie, N. Y.

A Self-Organizing Program for Describing Concepts

J. M. SNEDIKER
Case Inst. of Technology, Cleveland, Ohio

Tuesday, 2 to 3:30, Grand Ballroom North

Invited Papers
R. W. House, Chairman
Battelle Memorial Institute
Columbus, Ohio

Classification in Information Storage and Retrieval

O. E. TAULBEE
Goodyear Aerospace Corp., Akron, Ohio

Basic Problems of Automata Theory
R. J. NELSON
WRU-Case Program of Philosophical

Tuesday, 4 to 5, Grand Ballroom North

Computers in the Study of Learning
M. Kochen, Chairman
Univ. of Michigan
Ann Arbor, Mich.

NAMER: A Pattern-Recognition System for Generating Sentences About Relations Between Line Drawings
R. F. SIMMONS and D. L. LONDE
System Development Corp., Santa Monica, Calif.

BOGART: A Discovery And Induction Program For Games
C. NEWMAN and L. UHR
Mental Health Research Institute Univ. of Michigan, Ann Arbor, Mich.
Problem-Solving Procedures for Efficient Syntactic Analysis
S. AMAREL
RCA Laboratories, Princeton, N. J.

Tuesday, 4 to 5:30, Gold Room

Panel Discussion
Next Step in Programming Languages
P. Z. Ingerman, Chairman
Westinghouse Electric Corp.
Baltimore, Md.

J. SAMMET
IBM Corp.
D. ROSS
MIT
M. D. McILROY
Bell Telephone Laboratories Inc.
M. HALPERN
Lockheed Missiles and Space Co.
D. FERGUSON
Programmatics

Tuesday, 4 to 6, Cleveland Room

Information Retrieval
J. H. Kelley, Chairman
School of Library Science, Rutgers Univ.
New Brunswick, N. J.

The Relevant Response Theory of Information Storage and Retrieval
P. J. GLEASON
Library Consultant, Jamaica, N. Y.
Information Storage and Retrieval Using AVL Trees
C. C. FOSTER
Goodyear Aerospace Corp., Akron, Ohio

The Digital Handling of Chemical Structures and Associated Information
S. TAUBER
National Bureau of Standards, Washington, D. C.
Design and Installation of a Com-

puter-Based Information System for Chemical Abstract Service
W. C. DAVENPORT
Chemical Abstract Service, Columbus, Ohio.

Tuesday, 8 to 10 p.m., Grand Ballroom South

Panel Discussion
Recent Developments in Time-Sharing, Hardware/Software
T. B. Steel, Chairman
System Development Corp.
Santa Monica, Calif.

G. OLIVER
General Electric Company
D. SAVIDGE
Univac Division, Sperry Rand
W. S. HUMPHREY, JR.
IBM Corp.
R. K. NELSON
Control Data Corp.

Wednesday, 9 to 10:30, Grand Ballroom North

Invited Papers
Saul Rosen, Chairman
Purdue Univ.
Lafayette, Indiana

Soviet Computer Science, Revisited
E. A. FEIGENBAUM
Stanford Univ., Stanford, Calif..
Some Recent Developments In British Computing
S. GILL
Imperial College, Univ. of London, London, England

Wednesday, 11 to 12:30, Gold Room

Programming Languages for Non-Numeric Processing
R. W. Floyd, Chairman
Computer Associates Inc.
Wakefield Mass.

TRAC, A Text Handling Language
C. N. MOOERS and L. P. DEUTSCH
Rockford Research Inst., Cambridge, Mass.

Examples of Symbol Manipulation in the Ambit Programming Language
C. CHRISTENSEN
Computer Associates Inc., Wakefield, Mass.

TMG - A Syntax Directed Compiler
R. M. McCLURE
Texas Instruments Inc., Dallas, Texas

Wednesday, 11 to 12:30, Cleveland Room

Numerical Applications
H. S. Price, Chairman

Gulf Research and Development Co.
Pittsburgh, Pa.
R. S. Varga, Co-Chairman
Case Institute of Technology
Cleveland, Ohio

GEO-A Large-Scale Geodetic Application of the IBM Stretch Computer
C. SHEFFIELD and J. P. MORRIS
Computer Usage Co. Inc., Washington, D. C.

Updating the Product Form of the Inverse for the Revised Simplex Method
G. B. DANTZIG
Univ. of California, Berkeley, Calif.
R. P. HARVEY and R. D. MCKNIGHT
Standard Oil Co. of California, San Francisco, Calif.

Cycle Algorithms for Undirected Linear Graphs and Some Immediate Applications
J. T. WELCH, JR.
Goodyear Aerospace Corp., Akron, Ohio

Wednesday, 4 to 6, Gold Room

Panel Discussion
Uses of Real-Time Scope Systems
J. Carr, III, Chairman
Moore School of E.E., Univ. of Pennsylvania
Philadelphia, Pa.

K. KNOWLTON
Bell Telephone Laboratories, Inc.
G. CULLER
Univ. of California
B. FREED
Univ. of California
I. SUTHERLAND
Advanced Research Projects Agency, DOD

Wednesday, 4 to 5:30, Cleveland Room

Undergraduate Students Session
J. R. Oliver, Chairman
Univ. of Southwestern Louisiana
Lafayette, La.

Computer Analysis of Musical Style
A. J. GABURA
Univ. of Toronto, Toronto, Canada
FODESAR: FORTRAN Dependent Storage Allocation and Relocation Package
C. R. BAUGH
Michigan State Univ., East Lansing, Mich.

An Automated Real-Time Expressway Traffic Information and Control System
E. J. LEWIS, III
Technological Institute, Northwestern Univ., Evanston, Ill.

Wednesday, 8 to 10 p.m. Cleveland Room

SIGIR/Information Retrieval
L. C. Ray, Chairman

Grand Ballroom South

SICPLAN/Programming Languages
P. Z. Ingerman, Chairman

Terminal Room

SIGUCC/University Computing
Centers
T. A. Keenan, Chairman

Thursday, 9 to 10:30, Grand Ballroom North

Man-Machine Interaction
Ruth M. Davis, Chairman
Office of Dir. Defense Research
Eng.
Department of Defense
Washington, D. C.

Computer-Aided Programmed Tech-
niques in Support of Military Informa-
tion Systems
SYLVIA R. MAYER and R. MORGAN
USAF Electronic Systems Div., Hans-
com Field, Bedford, Mass.
Machine-Aided Design of Context-
Free Grammar
T. G. EVANS
USAF Cambridge Research Lab., Bed-
ford, Mass.

Thursday, 9 to 10:30, Gold Room

Panel Discussion
Legal Responsibilities of
Computer People
W. J. Almon, Chairman
IBM, Washington Systems Center
Bethesda, Maryland
R. FREED
Computer Control Co., Inc.
J. MOSHMAN
C-E-I-R Inc.
J. A. LARKIN
IBM, System Manufacturing Div.
M. ALLEN
Sherwin-Williams Paint Co.

Thursday, 9 to 10:30, Cleveland Room

Analysis of Computational Systems
B. F. Cheydleur, Chairman
Philco, Computer Div.
Willow Grove, Pa.
Cumulative Polygon Address Calcula-
tion Sorting
R. KRONMAL
School of Medicine, Univ. of Wash-
ington
M. TARTER
School of Public Health, Univ. of
Michigan

Discrete Markov Analysis of Compu-
ter Programs
C. V. RAMAMOORTHY
Honeywell Inc., Needham, Mass.
An Algorithm for Boolean Simplifica-
tion Based on Three Necessary Condi-
tions
M. J. MOORTGAT
Computer Dept., General Electric Co.
Falls Church, Va.

Thursday, 11 to 12:30, Grand Ballroom North

Panel Discussion
Design of Large Programs
J. D. Madden, Chairman
Association for Computing
Machinery
New York, N. Y.
B. W. ARDEN
Univ. of Michigan
T. KALLNER
IBM Corp.
J. A. POSTLEY
Informatics Inc.
E. WOLFE
Naval Command System Support Ac-
tivity

Thursday, 11 to 12:30, Gold Room

Programming Languages for
Non-Numeric Processing
W. C. Lynch, Chairman
Case Institute of Technology
Cleveland, Ohio
A Universal Assembly Mapping Lan-
guage
M. L. GRAHAM and P. Z. INGERMAN
Westinghouse Electric Corp., Balti-
more, Md.
An Introduction to the Cogent Pro-
gramming System
J. C. REYNOLDS
Argonne National Laboratory, Ar-
gonne, Ill.
Time-Sequenced Logical Simulation
Based on Circuit Delay and Selective
Tracing of Active Network Paths
E. G. ULRICH
TRW/Space Technology Laboratories,
Rendondo Beach, Calif.
An Extended ALGOL Based Language
G. E. HAYNAM
Case Institute of Technology, Cleve-
land, Ohio

Thursday, 10 to 12:30, Cleveland Room

Management Information Systems
A. Holzman, Chairman
Univ. of Pittsburgh
Pittsburgh, Pa.
Industrial Production and Digital

Computers
O. I. FRANKEN and M. D. ROMER
Technical Univ. of Denmark, Lyngby,
Denmark
A Modular Approach to Business EDP
Problem Solving
JAMES R. ZIEGLER
National Cash Register Co., Haw-
thorne, Calif.

Thursday, 2 to 3:30, Grand Ballroom North

System Optimization
B. W. Arden, Chairman
Univ. of Michigan
Ann Arbor, Mich.
A Mass Memory System Designed for
the Multi-Program Multi-Processor
Users
J. DOBBIE and D. C. ZATYKO
General Electric Co., Phoenix, Ariz.
Application of Mathematical Program-
ming Techniques to Information Proc-
essing Problems
H. E. THIESS
Naval Command Systems Support Ac-
tivity, Washington, D.C.
Automatic Flow Chart Design
G. HAIN
Dynalectron Corp.
K. HAIN
NASA Goddard Space Flight Center,
Greenbelt, Md.

Thursday, 2 to 3:30, Gold Room

Panel Discussion
Graduate Programs in Computer
Science
C. C. Gotlieb
Univ. of Toronto
Toronto, Ontario
S. CONTE
Purdue Univ.
G. FORSYTHE
Stanford Univ.
S. GORN
Univ. of Pennsylvania
S. PARTER
Univ. of Wisconsin
H. GARNER
Univ. of Michigan

Thursday, 4 to 5:30, Grand Ballroom North

Invited Papers
L. R. Lavine, Chairman
RCA Corp.
Princeton, N. J.
Observations on Time-Shared Systems
J. I. SCHWARTZ
System Development Corp., Santa
Monica, Calif.
A New Programming Language
R. A. SIBLEY
IBM Corp., Poughkeepsie, N.Y.

PESSIMUM PROGRAMMING

the road to security

by R. THOGONAL

So much time and effort has been devoted to optimum programming techniques that it seems worthy to devote some time and effort to its counterpart—pessimism programming. The most obvious benefits from its utilization are:

1. Running time is longer, resulting in increased percentage of machine utility. Everyone knows the accounting department is unhappy about idle machines. Furthermore, if machine utility goes high enough, it will be possible to justify additional machines.
2. Pessimized programming can be done by much less expensive personnel.
3. Because of the decreased per-man cost resulting from (2), above, more personnel can be added to the payroll, increasing the probability of obtaining government contracts, to say nothing of the empire building possibilities.
4. Pessimism programs are not constrained by the old cliché of trading core space for speed and, as a result, they can frequently occupy less memory than their optimum counterparts. Memory space thus saved can be utilized for on-line comments.
5. Pessimism programs always take less check-out time. This time approaches zero in the optimum case; i.e.,

$$\lim (T_c) = 0$$

$$P \rightarrow P_{opt}$$

As an excellent example of pessimism programming, observe that the following square root program (which will obtain the square root of the number stored in the memory location specified by index register 2) has only nine instructions! With only *one* modification, it will also be applicable to floating point arguments.

PROOTY	CLA	PPABIT	
PPLOOP	STO	PPROOT	
	LDQ	PPROOT	
	MPY	PPROOT	(OR FMP FLOATING P.P.ROOT IS WANTED)
	SBM	0,2	
	TPL	1,4	
	CLA	PPROOT	
	ADD	PPABIT	
	TRA	PPLOOP	
PPABIT	PON		
PPROOT	PZE		

Unfortunately, the running time for this is short when small arguments are used, but it is felt that an occasional dummy entry with the largest possible argument will overcome this objection. The time required for this argument would be 95,007 years, 329 days, two hours, 14 minutes, and six seconds, which shows the machine is too slow.

One might think that the ultimate optimum in pessimism programming would be:

XEC *

but this is not true. In this case, the machine *tries* to do something; and in case of a machine failure, it might succeed. The ultimate is obtained by turning the POWER ON switch to the OFF position. The latter also cuts down on overhead.

Numerous techniques immediately come to mind whereby programs can be pessimized; e.g.,

AXT 5,4

STZ BLOCK, 4
TIX *-1, 4, 1

can be pessimized by changing the address of the last instruction from *-1 to *-2. Note that this can even be done by a keypunch operator, thus eliminating the cost of indoctrination of programmers into pessimizing practices.

So many of the pessimizing practices have been utilized during debugging that they hardly seem worth mentioning: console debugging, on-line dumps, sleeping operators, misplaced tapes and cards, looping core, cables kicked loose, etc. However, in the overall pessimizing problem, these should not be overlooked.

When a problem reaches the production stage, one must be even more ingenious to pessimize it; but a little foresight will ensure that it runs pessimally. Things like

- a) 14 original copies;
- b) multiple passes, each requiring a different program, preferably intermediate EAM runs;
- c) *must* be run on prime shift;
- d) *highest* priority;
- e) printing of blank lines instead of carriage commands;
- f) no restart procedures, etc.

immediately come to mind. However, if these were not initially implemented, one has to resort to

- a) lack of (or loss of) running procedures;
- b) frequent change of operations personnel;
- c) reprogramming parts of the problem;
- d) requirements of additional types of output;
- e) quintessentially, reprogram the problem in pessimized form;
- f) enlist the aid of the manufacturer to change the machine's execution of instructions;
- g) persuade management to replace the current equipment.

Not infrequently, (certain members of) management will discourage pessimizing practices, but these unlightened individuals are, fortunately, rare. Usually no one listens to them because they have a habit of making themselves unpopular by concentrating on efficiency and other unimportant items. When a sufficient number of pessimized programs are being run, these sore losers will quit and join another company.

Remember! Rome wasn't built in a day, so don't go making things look easy by making a program run too fast. There might be time to solve *all* the problems that way. And there goes your job security!

-REMEMBER-

PARSIMONIOUS PERSONNEL PERENNIALY PERUSE
THE POSSIBILITY OF PESSIMIZED PROGRAMMING!
PERSPICACIOUS PROGRAMMERS PERSEVERE IN THE
PURSUIT OF PALTRY PROBLEMS!

Although writing here under a pseudonym, Mr. Thogonal's serious intent is indicated by the lengthy list of jobs he has held—an obvious reflection of the application of the practice he espouses in this paper. The paper, by the way, has been rejected by numerous conference committees and journals that failed to see the beneficial implications of documenting in public a practice so dear to so many.

THE BURROUGHS B8500

thin films
and monolithic i. c.

by JOHN T. LYNCH

Functional, as well as physical, modularity have been distinguishing characteristics of Burroughs Corp.'s edp line, the B5500 and its military counterpart, the D825, being outstanding examples. The latest addition to the line, the B8500, exploits this modular system design concept. In the B8500, as many as 16 computer and input/output modules and 16 memory modules—each containing 16,384 (52-bit) words stored in magnetic thin film—can be combined with modular disc files, tape units, communications networks, and other peripheral devices to form a system. To ease expansion, processor, memory, and I/O modules can be added and operation begun immediately without interruption to the system. All software is written to utilize the equipment available at a given moment in any system configuration.

hardware characteristics

The B8500 makes extensive use of monolithic integrated circuits—integrated versions of the discrete circuits used in Burroughs' 30mc systems as early as '59. The storage medium consists of magnetic thin film.

The B8501 computer module incorporates a 20mc clock and employs multi-processing and look-ahead techniques to increase processing speeds. The computer module includes an arithmetic stack for automatic call-up of operands, a variable syllable instruction format and a 48-bit operand, as well as a local scratch pad memory. Associative indexing permits any memory word to be used as an index word rapidly and automatically. Stack extension permits the arithmetic stack to be pushed down in local memory to a depth of 16 words without recourse to main memory storage.

Up to 512 simplex peripheral channels may be buffered and controlled by a single B8510 input/output module, handling peripheral devices such as card readers, magnetic tape units, Teletype equipment, display devices, etc. Additional devices can be handled if the I/O channels are multiplexed. The I/O module contains an independent processing capability, minimizing computer monitoring. One of the primary functions of the I/O module is to automatically enter into disc files the low-speed data coming from external peripheral devices. The central processor thus services peripheral devices from the disc file, increasing the efficiency of the system. I/O module functions include:

- Independent and interlacing channel operations,
- Storing or fetching to or from main memory,
- Accumulating a word in a variety of byte sizes,
- Testing for word count and character coding,
- Modifying the main memory address field,
- Sequencing descriptors for extended I/O operations.

The combination of descriptor word flexibility and a rapid channel servicing cycle have made the I/O a

significant element of the system. It is important for the descriptors to control the flow of data into and out of the system, minimizing the amount of computer monitoring. In this respect, the I/O is semi-autonomous. Thus, data is neither slowed down for lack of I/O response nor is the computer hampered by a continuing need to supervise every detail of each of the many I/O transactions.

B8500 Modular Data Processor

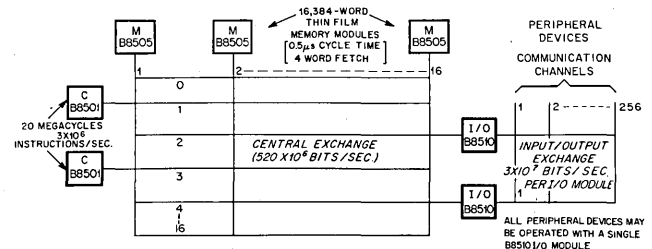

External requests for service are specially encoded for fast recognition by the I/O module. I/O service programs communicate directly with peripheral equipment and begin the necessary response to the request. If the request requires processing in the computer module, an interrupt is passed on to the computer for the proper scheduling of the request for service. The external requests are treated to minimize computer module attention.

The B8500 system utilizes a hierarchy of memories ranging from 0.1-microsecond cycle thin film memory in each computer module through the 0.5-microsecond cycle thin film main memory to the disc file system and tape storage. Throughput is maintained at a high level by balancing the flow of information among these various memories. The B8500 executive program manages this information flow so that data is available in the 0.5-microsecond main memory storage when required for the programs to be executed.

Look-ahead logic transfers data and instructions from 0.5-microsecond memory to 0.1-microsecond memory for execution. The former memory communicates with the next level in the hierarchy, namely the disc system, which has an average transfer time of 5 microseconds per word. In general, the executive routine collects programs and data in the disc file before initiating their execution. As much data as is needed at any one time is then brought into the 0.5-microsecond memory by the executive program.

The B8505 memory module is a 16,384-word thin film

Mr. Lynch is manager of Advanced Development of Burroughs' Defense, Space and Special Systems Group, Paoli, Pa.

THE B8500 . . .

memory, 52 bits per word, with a full cycle time of 0.5 microseconds. Words can be stored or fetched in four-word groups so that the maximum data rate possible for a single memory module is 416×10^6 bits/second. In addition to the speed, a selection of logic operations have been installed in the memory module. The B8500 system permits expansion to up to 16 of these modules for a total of 262,144 words, each of which is randomly and directly addressable.

The disc file storage modules are mechanically identical to the unit used in the B5500 and B200/B300 series computers. Up to 50 storage modules may be included with each B8500 system for a total of 60 million (52-bit) words.

The average access time is 20 milliseconds. The transfer rate is 10.4 million bits per second. Two important design features of the disc file system have made such speeds possible. The head-per-track organization eliminates the need for mechanically positioned head assemblies, and permits paralleled read/write operation which accesses eight tracks simultaneously.

software

In the B8500, the concept of modularity is applied to the software too. The operating system has two major sections. The central section is the Executive and Scheduling Program (ESP). ESP performs those functions normally associated with an operating system such as I/O control, interrupt control, timing, etc. Surrounding the ESP is a collection of service and system programs. A service program is defined as a program written much like a user program in compiler language, but possessing direct contact with portions of the system normally reserved for the ESP. An example would be a program

A model of the B8500 System

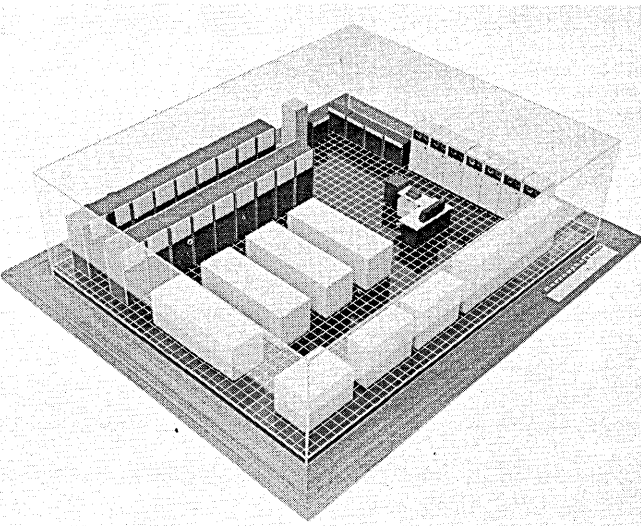

allowed to communicate directly with Teletype channels, as opposed to making a call on ESP to perform the communication. A systems program is defined as a user program permanently available for all users, e.g., compilers, assemblers, I/O procedures and filing routines.

Modularity is achieved by requiring all program segments to conform to a standard structure. The compilers, the programs they compile, and most of the operating system utilize the standard structure. The ESP is a small set of routines which forms the heart of the operating system and does not conform to the standard structure.

The total software package is composed of a collection of small segments or modules. At any given time in the execution of the program, only the active segments need to be in memory; large contiguous areas are not required. Therefore, programs can be run with varying amounts of memory.

Program segments operate independently of their location in memory so that during the course of a job, program segments may be executed from several different places in memory. This movement of program segments in memory requires no modification of the segments.

The Executive Scheduling Program (ESP) is written to handle the maximum B8500 system configuration (16 memory modules and 16 processor or input/output modules). This approach permits automatic self-regulation as configurations change and provides the basis for automatic scheduling around any malfunctioning module. The executive program supervises the compilation of all programs to generate data and program objects in a format that permits most efficient handling. Memory bounds and dynamic storage protection permit programs to be debugged while production programs are being executed.

The principal function of the ESP is to dynamically allocate equipment modules, such as processors, memory, and I/O channels, to a constantly changing set of jobs. Sharing equipment modules among many programs is generally called multiprogramming. The ESP goes a step further by multiprogramming a set of jobs that consist of both user requests and operating system functions.

The interrupt system for the B8500 is responsive to interrupts generated within the computer module and those received from sources external to it. Every interrupt received by a computer module is an indication to the ESP of some set of functions which have to be performed, are being performed, or have been performed. The function of interrupt processing is to evaluate and pre-process each interrupt prior to passing it on to the major portion of the ESP for final disposition.

A judgment must be made on each interrupt condition to determine if it is to be passed on to the ESP or handled completely by the interrupt processor. Interrupts which are passed on to ESP are mapped into a consistent form to allow convenient and economical handling by the appropriate ESP routine.

All of the operating system, including the compilers, are written in Extended ALGOL. Memory protection and an extensive file system are also included in the operating system. This filing system provides reference to files and file items by name rather than absolute location or storage medium.

The B8500 Extended ALGOL compiler uses the compiling technique known as recursive descent syntactic analysis. This technique, used in the B5500 ALGOL compiler, compiles quickly, makes modifications easier and produces good object code. B8500 Extended ALGOL implements virtually all of ALGOL 60, and provides extensions for I/O operations, partial word operations, string manipulation, and diagnostics.

The B8500 FORTRAN IV compiler implements the A.S.A. FORTRAN IV language. The compiling is done in one pass using conventional precedence scan techniques. Library programs written in Extended ALGOL can be called in FORTRAN, making it unnecessary to include any assembly language coding.

The B8500 COBOL compiler implements D.O.D. COBOL 61, Extended. All the additional features in B5500 COBOL are also included in B8500 COBOL. In addition, data segmentation and the ability to compile program segments independently are also included. The character operations in the B8500 are well suited for working with character fields as required in COBOL. ■

IN-HOUSE TAPE REHABILITATION

a user report

by J. J. DeJIANNE

Recognizing the need for continual evaluation of new techniques appearing on the market, the Bell System created the EDP operations group, which periodically holds meetings to evaluate new operating methods and techniques. One of the subjects studied, because of its apparent advantages in cost savings and increased efficiency, was magnetic tape rehabilitation.

Three years have passed since a tape cleaner and a certifier were added to our computer installation. The tape cleaner is completely mechanical, safe, and simple to operate. It consists of a scraping station which employs tungsten carbide blades for removing oxide buildup, and two cleaning stations where loose oxide, dirt, lint, and other particles are wiped from each side of the tape. The silicon tissue used in the wiping operation removes static charges, as well. Both blank and recorded tapes can be cleaned with equal safety.

The tape certifier, which must be connected to a tape drive, inspects the tape for defects that might cause loss of information. All channels of the tape are inspected simultaneously at densities of up to 556 bits per inch in a single pass at full transport speed. The certifier can be converted to inspect at densities of up to 800 bpi. The certifier determines tape condition by continuously comparing the peak amplitude of a recorded bit with the threshold voltage selected by the operator. This voltage, which is indicated on the panel meter of the certifier, is adjustable from 20% to 80% of the normal signal level.

The same meter monitors the readback amplitude of the individual channels and the average of all channels. Dropouts are caused by tape defects such as foreign matter, oxide holes or creases. When the readback signal falls below the preset threshold level, the tape stops, placing the defect location in a suitable area for visual inspection. In most cases, the defect can be removed by wiping the tape with a standard tape liquid cleaner. In some instances, it may be necessary to remove the defect with a scalpel. A recheck of the trouble spot can be made by back-spacing and restarting the tape.

A reel of tape may be passed in control of the certifier in approximately 10 minutes if no stops are encountered. Each stop requires approximately two minutes to resolve.

economics of the system

At A. T. & T., the cleaner and certifier are operated by a general clerk, which is our entry grade. On the

average, an operator can clean and certify approximately 17 reels of tape per day. Certification being a repetitious and tedious job, there are naturally problems encountered in assigning a clerk to this job exclusively. We periodically rotate operators on this job.

On the basis of certifying 3,000 reels a year, the cost of contracting this volume of tapes to an outside certification service would be between \$31,500 and \$43,500, depending upon the number of reels we could release at any one time. The cost of our cleaning and certifying for the same number of reels with these machines is as follows:

Cost of Tape Cleaner	\$ 985.00
Cost of Tape Certifier	\$4,400.00
	<hr/>
Operator's salary	\$4,000.00
	<hr/>
Total:	\$9,385.00

Savings are between \$22,000 and \$34,000 for the 300 reels of tape. These figures are exclusive of tape drive rental. We are of the opinion that the cost of most outside service certification in relationship to the purchase price of a new reel of tape does not economically make such service usually desirable. For example, the typical certification service prices range from \$10.50 to \$14.50 per reel de-

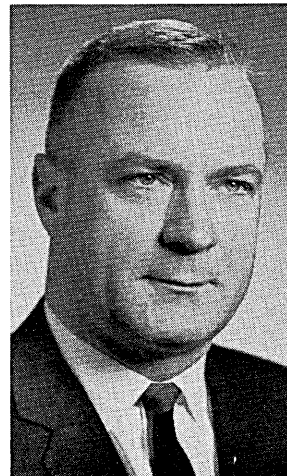

As data processing supervisor at AT&T, Mr. DeJianne is responsible for the operation of a computer center with a tape library of more than 7,000 reels, surrounded by an IBM 7074 and four 1401's. The operation performs such functions as payrolls, stock processing, and statistical reports. With the firm since '58, he was formerly with New Jersey Bell. He has attended the Newark College of Engineering.

now
15
copies

AT ONE TIME

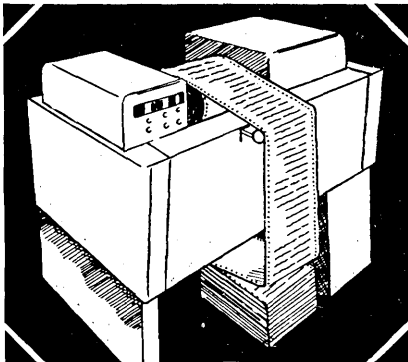

with HURON
CAR/BOND®
PAPER

Eliminate costly extra runs or secondary duplicating operations . . . HURON CAR/BOND® Paper will deliver up to 15 clear copies from one print-out operation.

The proof is in the printing, so try HURON CAR/BOND Paper as our guest. We'll send you a sample set run on an IBM 1403 and a supply of blank sets to run on your own equipment. Once you're convinced, contact your business forms manufacturer and specify HURON CAR/BOND Paper by name. There is no substitute!

To speed up and cut costs of manually typed carbon copies, use HURON COPYSETTE—the preferred manifold carbon paper set.

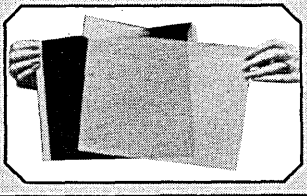

**PORT HURON
PAPER COMPANY**

PORT HURON, MICHIGAN 48061

TAPE REHABILITATION . . .

pending upon the number of reels certified at any one time. This averages out to approximately 25 to 40% of the cost of a new reel. One out of every three or four reels in a tape library could be replaced with new reels as an alternative to using this service for the same cost.

operating experience

In the first two full months of operation, during which time 600 Mylar tapes were cleaned and certified, a detailed performance measurement was compiled. Of the 600 tapes cleaned and certified, 480 were manufactured by Co. "A" and 120 by Co. "B". The total defects encountered on the 480 "A" tapes were 2,168. Of these, 1,942 or 90% were removed and 226 or 10% were non-removable. Of the 120 "B" tapes certified, 914 defects were detected. Of these, 808 or 88% were removable and 106 or 12% were non-removable. The non-removable defects consisted of creased tapes, oxide holes, stretched tapes and nicked tapes. A consideration of the age of the tape was a definite factor in the findings. The "B" tapes were purchased at initial cutover time four years ago. Our "A" tapes averaged slightly more than two years in age. A definite relationship was proven by this study. The "B" tapes proved to have 40% more defects than the relatively newer "A" tapes which were approximately half their age.

On our 7074 conversion from 705, we anticipated that there would be some tape-read failures which would occur due to non-removable defects in certifying. However, we realized that a good portion of these defects would appear either in an inter-record gap or an unused channel. The results were 16 tape-read failures on 406 input reels under actual operating conditions.

While we believe that this method of tape certifying is most economical in our installation, the appreciated savings would vary in other installations, depending on the size of the tape library and the number of reels available

Cybertronics Model C-3 magnetic tape certifier for use with IBM tape drives.

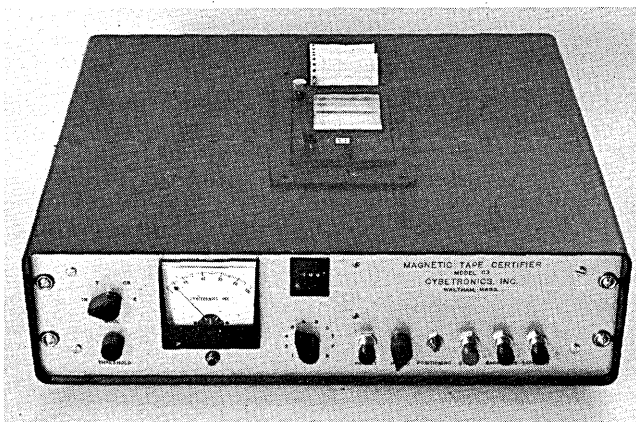

to be certified at any given time. Another consideration would be the availability of a tape drive for an extended period of time. We do not presently have 100% use of a spare tape drive for certification; however, we have the tape drive availability to certify approximately 70% of the time.

In addition to the savings in tape cost shown above, even more important are the savings in lost computer time resulting from unnecessary reruns and rescheduling due to excessive dropouts and catastrophic loss of data previously written on a tape requiring complete reconstruction of the data. ■

We go farther than the DP department

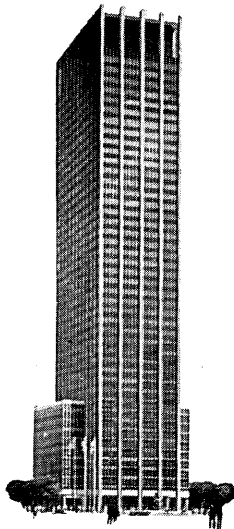
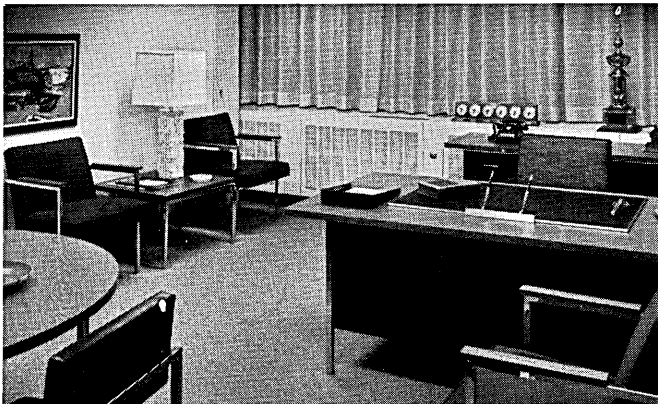
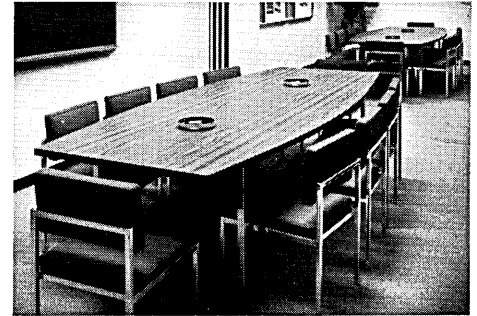

Steelcase/Datacase recently furnished offices in J. C. Penney Company's new 45-story headquarters building in New York

Data processing department, executive offices, general offices, reception areas—almost any place you look in J. C. Penney Company's handsome new building, you'll see furniture by Steelcase/Datacase. All perfectly coordinated in design, color and function—and so durably constructed that the entire office complex will retain its fresh appearance for years. Your local Steelcase/Datacase dealer offers you a broad choice of furniture and data processing auxiliary units. And, he delivers, installs and services quickly and knowledgeably. Call him, he's in the Yellow Pages. Or, write Dept. D, Steelcase Inc., Grand Rapids, Michigan; Los Angeles, California; Canadian Steelcase Co., Ltd., Don Mills, Ontario.

DATACASE[®]/BY STEELCASE

OFFICES AND SHOWROOMS: NEW YORK • CHICAGO • GRAND RAPIDS • ATLANTA • DALLAS • LOS ANGELES • PHILADELPHIA • PORTLAND, OREGON • TORONTO • MONTREAL

Versatility is a c

Probably the single technological advance which has contributed most to the versatility of modern computers is the coincident-current core memory.

Here's a quick "once over lightly" of the rudimentary facts associated with this electromagnetic device that has revolutionized the data processing industry.

The basic laws of electromagnetism coupled with some of the special properties of ferromagnetic materials make the coincident-current core memory possible.

The ferrite memory core has two states of remanence, each state having an opposite polarity. A core can be placed in either state by the application of a magnetizing force which is greater than the coercive force of the material in the core.

Since the coercive force of the core is so precisely controlled during manufacture, that force can be used as a threshold for the purpose of providing a two-input logical "and" function. This allows an N by N array of X and Y coordinate conductors to select N^2 storage elements.

The coordinate conductors produce a magnetizing force when current is passed through them. This force is summed at the coincidence of X and Y conductors where they pass through the center of a selected core. Hence, the term "coincident-current core selection" refers to the memory access scheme that uses this

method of selecting a storage element by applying half the necessary magnetizing force through each of the X and Y coordinate conductors.

When enough force is applied to overcome the coercive force of the core, it "switches" rapidly to the opposite state of remanence. While it is switching, it induces a current in a sense line passing through its center. This sensed current pulse is amplified and used in a computer's data control circuits as a binary "1" or "0", depending upon the polarity of the core before it switched.

As a data storage element the memory core has the advantages of consuming no power while it stores information and because of the controlled nature of its material, it is able to perform a logic function. This logic function is the real secret of economy and reliability. It makes possible random access of information in large core stacks with a minimum of selection circuitry. It provides the versatility of many types of access modes to match the various functional demands of computer organization.

The coincident-current core memory is as standard as the transistor in the mind of the computer designer. It is now the ordinary way to achieve fast, reliable, and versatile information storage.

We thought it might be interesting to review the basics again for those who have come to take the "heart" of the computer for granted.

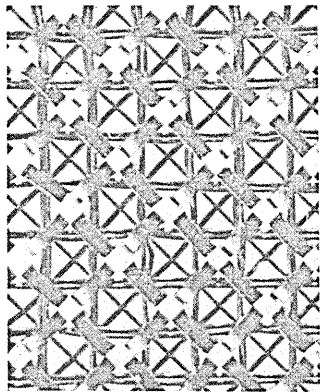

A typical four-wire core memory matrix uses X and Y wires to carry write/read currents. When an X and a Y wire, each carrying half of the necessary current needed to switch a core, sum their magnetizing force at a coincidence, that particular core switches polarity.

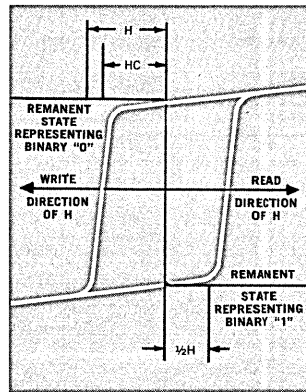

Here's how the currents switch a core from one remanent state to the other.
 H — Force to switch from one remanent state to the other
 B — Total magnetic flux in either remanent state
 HC — Force to bring core from remanent to neutral state
 $\frac{1}{2}H$ — Can be applied to core without switching core state

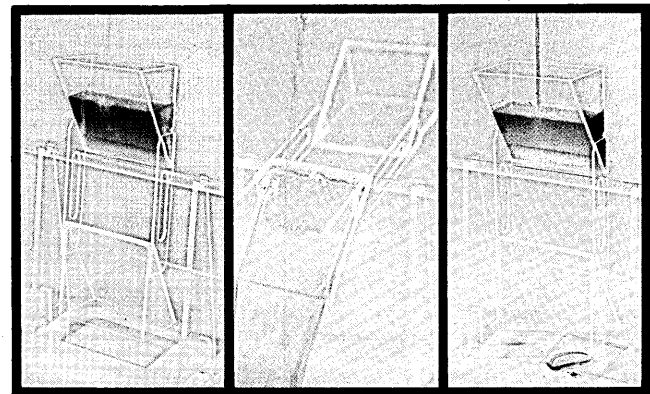

- 1 This mechanical device simulates the switching action of a coincident-current memory core. A half current from one of the coincident drive lines ($\frac{1}{2}H$) produces a force which fails to overcome the coercive stability of the core. (The red fluid represents write currents in a given direction.)
- 2 When the magnetizing force of another half current is summed with the force of the first half current, the core's coercive force is overcome and it switches rapidly to the opposite remanent state.
- 3 Once flipped or switched, the core is in a remanent state of the opposite polarity, ready to be switched again if two reverse half currents are applied as before. (The blue fluid represents read currents in the direction opposite to the write current.)

This is the first of a series of six brief discussions on the basic principles of core memories. If you would like the complete series in booklet form, please circle 55 on reader card.

coincidence!

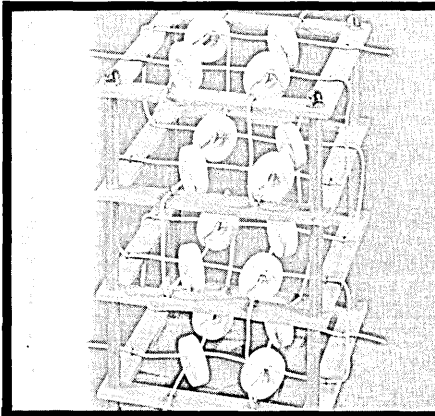

Mock-up of a coincident-current core memory stack having a capacity of four words with four bits per word. X and Y write and read wires (white) are shown strung through the cores in a typical fashion.

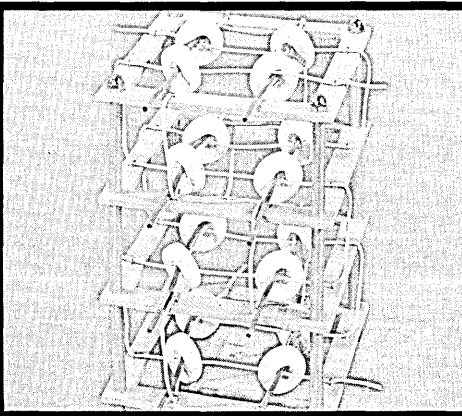

Mock-up with X and Y and Inhibit wires (blue) strung. Each plane has its own Inhibit line. The Inhibit wire is energized with current in opposition to Y line currents to retain a "0" value in a selected core during the memory loading operation.

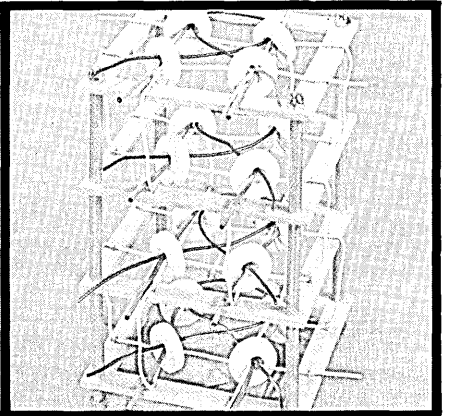

Mock-up with all lines strung including the sense line (red). Each memory plane has its own sense line. When a core is switched by passing the proper currents through selected X and Y lines, a current is induced in the sense line to provide an output signal from the memory stack.

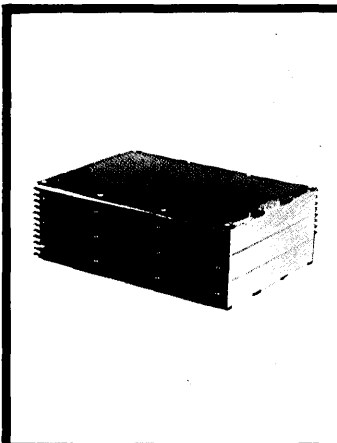

Series MC Compact ruggedized memory system.

- For industrial, van-mount, aircraft and military applications
- 4-usec cycle time, plug-in circuit modules
- Meets rugged operating requirements
- Capacities to 4096 words with 26 bits per word



Series ML Integrated-circuit core memory system.

- Takes advantage of integrated circuit economics
- 5-usec cycle time, interfaces with either integrated or discrete circuitry
- "Big-board" packaging for greater economy and simplicity
- Relay-rack packaging, up to 2048 words with 26 bits per word

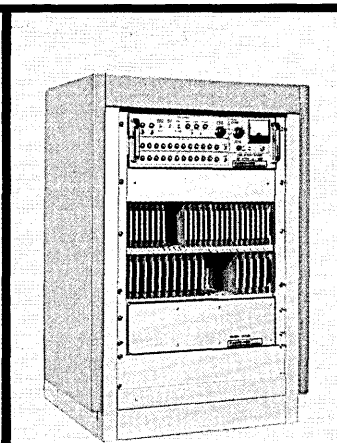

Series MF One-microsecond memory system.

- Use where high speed and high reliability are mandatory
- 1-usec cycle time, 450-nsec access time, high operational margins
- All silicon semiconductors & well-known Fabri-Tek maintenance features
- Many options available for any high-speed memory requirement

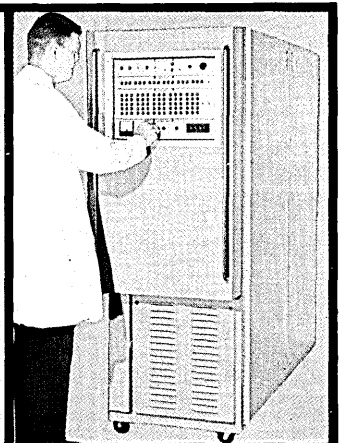

Series MT Mass core memory system.

- Up to 21-million bits stored for high-speed access
- 4-usec cycle time, coincident-current versatility with only two wires per core
- All silicon semiconductors, interfaces with integrated or discrete circuitry
- Orthogonal core array enhances economy and overall system reliability



All these versatile Fabri-Tek memory systems use the principles of coincident-current core memories in their information storage stacks. Check the system that interests you and send this coupon to Fabri-Tek Incorporated, Amery, Wisconsin; or call 715-268-7155 or TWX 510-376-1710. You'll receive complete data.

Name _____ Title _____

Company _____ Address _____

FABRI-TEK LEADS IN MEMORY TECHNOLOGY



CHECK DIGIT VERIFIER

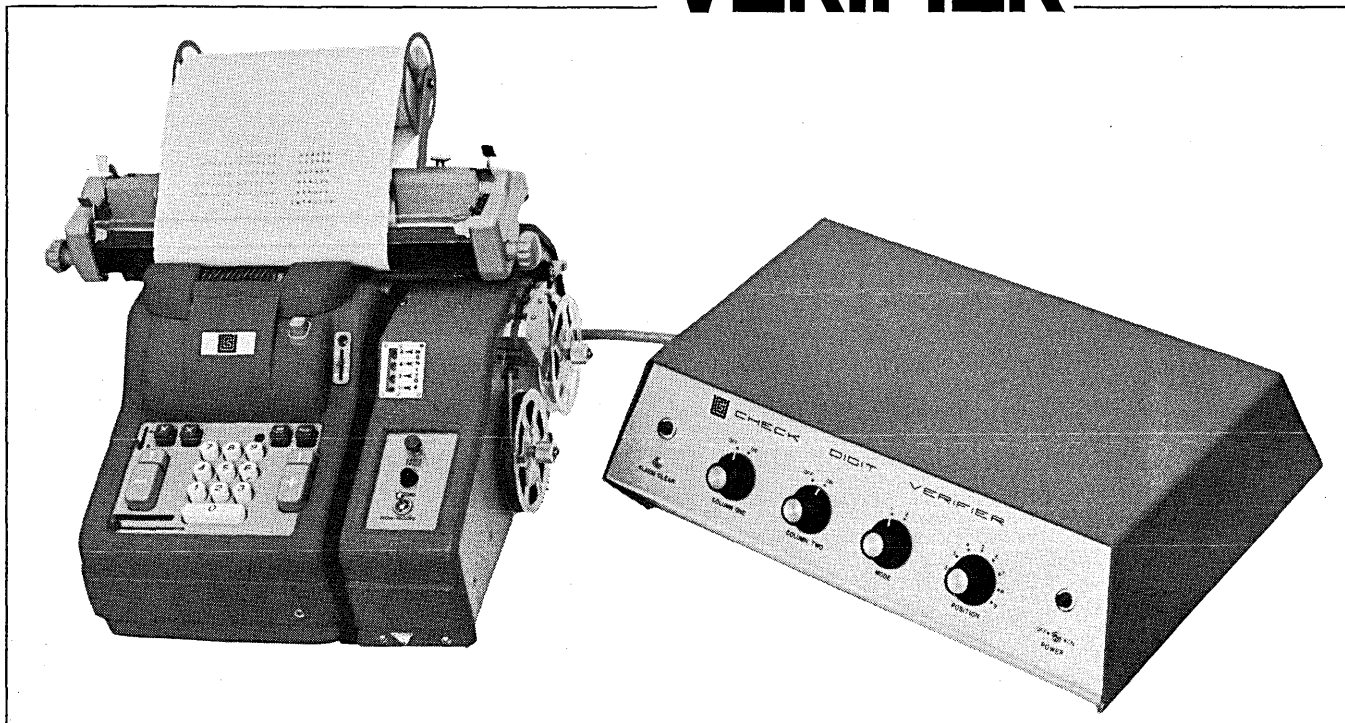

CAPTURE DATA ON MAGNETIC TAPE...VERIFY IT SIMULTANEOUSLY

Now SODA offers new data acquisition capability—as an optional feature of the Amcorder®, the Check Digit Verifier gives you a positive data validity monitor for those applications requiring account or identification number verification at the time of entry. As the Amcorder® records data directly on magnetic tape, the Verifier electronically calculates check digit verification. Erroneous entries are flagged with both an audio signal and a visual alarm. To clear the

system, the operator simply keys in an "error correct" code and then re-enters correct data.

The Amcorder®, an easy-to-use ten-key adding machine captures data on 1/4" magnetic tape in BCD format. Resultant tapes are then read through a UGC Instruments Interpreter directly into the computer. The need for key punching is virtually eliminated. Portable recording devices are also available.

FULL INFORMATION on the complete SODA System is

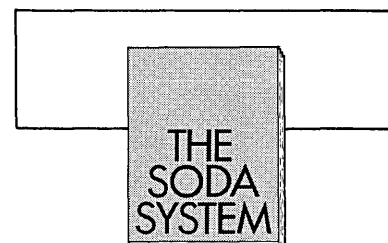

available in this 48-page brochure discussing hardware, system design considerations, conversion routines, and applications. Write UGC Instruments, Inc., Customer Information Services, 5610 Parkersburg Drive, Houston, Texas 77036.

 **UGC INSTRUMENTS**
Source Oriented Data Acquisition

CIRCLE 25 ON READER CARD

1620 Users,
you can move
up to Raytheon
Computer's 520 System and process
existing

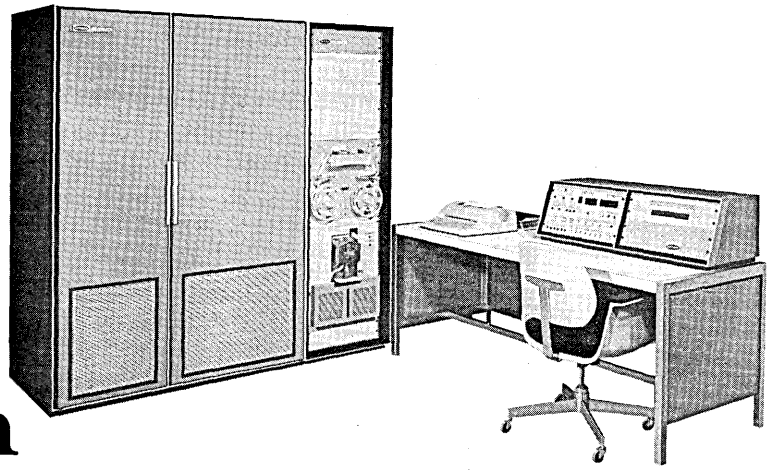

programs three
times faster. It's
done with the
Raytheon 1620
Simulator.

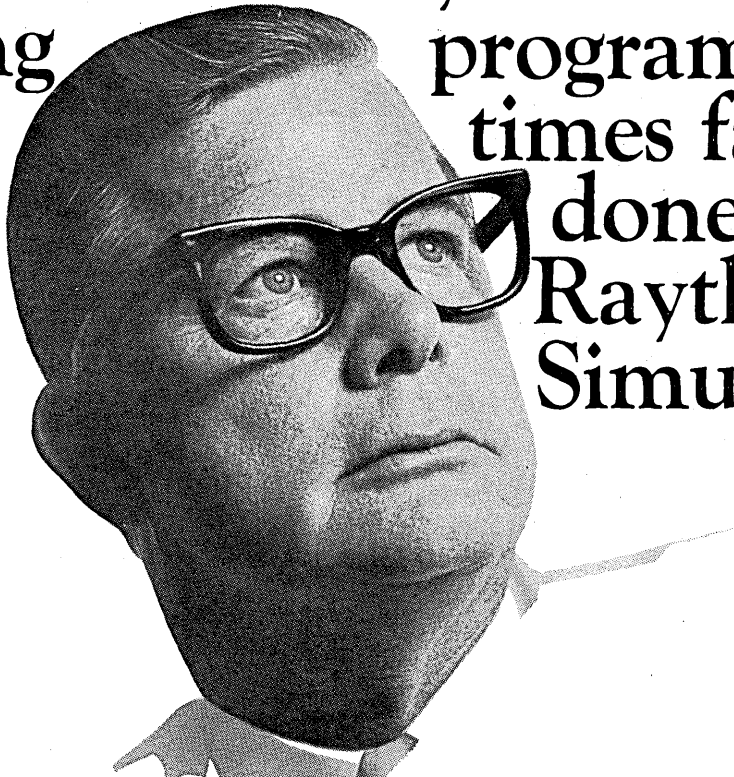

Raytheon Computer's 1620 Simulator allows you to move up to the 520 and still use your valuable 1620 I or II program library. Not only do you keep your existing programs, but you can run them much faster and more efficiently. And there are *no* program conversion costs.

When you switch to the 520 you move up to the industry's new price/performance leader. It offers substantial speed advantages in scientific and data systems computing. For example, floating point operations include a 24-bit addition in 21-36 μ secs and a 24-bit multiply in 25-28 μ secs. The 520 is the only computer in its class that can be optionally equipped with a 200 nanosecond access non-destructive readout memory for function generation, table-lookup and subroutine storage.

You'll also get a software system second to none, including FLEXTRAN, a compiler-assembler, 520 FORTRAN, and the BOSS operating system in addition to the 1620 Simulator itself. Raytheon's new 520 FORTRAN processor makes it possible for you to run your 1620 FORTRAN programs approximately 60 times faster than you can with your 1620.

There is no more practical way to move up to a modern system that will satisfy the requirements of both management and your programmers. Why not switch to the Raytheon Computer 520 System? Write or call for details. They're all in Data File C-114. Raytheon Computer, 2700 South Fairview Street, Santa Ana, California 92704.



PROGRAMMERS AND CHEAP COMPUTING

by T. B. STEEL, JR.

This paper takes as its point of departure the one premise that the long-range effect of a growing batch-fabrication technology will be to realize a very substantial increase in the speed, capacity, reliability, and complexity of digital computers. A concomitant assumption is that this potential performance gain will be accompanied by a substantial reduction in the cost of systems of all sizes.

To make a discussion of programming for tomorrow's machines meaningful, it is necessary to quantify these assumptions.

the prediction game

Conventional practice for engineering extrapolation—at least when the extrapolator plans to publish his results—is to proceed conservatively, plotting trends and carefully noting all the difficulties that might slow progress. The sophisticated in prediction technology will take care, of course, to place his trend plots on logarithmic paper, and for two or three years his results will closely match reality. Later, however, these carefully drawn expectations will become, with increasing velocity, gross underestimates. The entire history of science and technology is a witness for the truth of this proposition. The combined effects of the unexpected, serendipity, synergism, and plain hard work have invariably led to progress more rapid than anticipated.

An alternative procedure is to throw caution to the winds and—with due regard for fundamental limitations such as the finite speed of light—predict the greatest technological advance for which one can conceive a possible avenue of accomplishment. Even predictions formulated in this manner are likely to be conservative, but they are almost certain to be nearer the mark than those generated with prudent rationality.

One cannot be so rash in making predictions about details. Clearly many things can occur that will either stifle or accelerate progress in a specific area such as increasing the speed of an adder constructed by thin film deposition technology. The predictions required here are not of this detailed sort, however. What is needed are approximate estimates of effective gains in the performance and cost of *total systems*. In looking at a total system context

effects of
batch fabrication

we see that breakthroughs of unexpected character in one area will tend to be balanced by unanticipated problems in another. Thus, in the mean, integrated predictions will have general reliability.

This problem of reliable technological forecasting is worth a paper in its own right and is certainly not a central element of the present discussion. Thus, rather than elaborate a detailed forecast and attempt to justify it, I will, instead, note a few guiding principles, announce some numbers, and proceed to a discussion of their implications. The actual values of the numbers are not important for the conclusions to be drawn; only their qualitative character is vital.

lead times

The lead time for turning a laboratory curiosity into a functioning component of commercially available hardware has been, typically, about 10 years for digital computing systems. The transistor is a good example. Military urgency has tended to cut three or four years from this cycle for equipment entering service inventories. There is some evidence that this lead time is getting shorter,



Mr. Steel is a computer systems scientist in the Advanced Technology & Research Directorate of System Development Corp., Santa Monica, Calif., and a senior research leader of the Information Processing Research staff. He is particularly concerned with applications of mathematical logic to dp theory. He is AFIPS rep to the IFIP TC-2 Programming Language committee, and secretary of X3.4 Common Programming Languages subcommittee. He holds a BA and MA in math from U. of California.

*This article is based on a paper delivered at the symposium, "Impact of Batch Fabrication on Future Computers," sponsored by the IEEE Comput-

er Group in Los Angeles.

largely as a result of increasing ability on the part of manufacturing organizations to respond to technological innovation. It seems almost axiomatic that batch-fabrication technology will add fuel to this fire and that we can look at the new toys in research laboratories and have a fair clue about the nature of the hardware that will be available in the early 1970's.

Due to the lack of a specific point comparable to initial delivery of hardware, it is a little more difficult to determine a meaningful lead time for software. Programs are delivered and distributed in widely varying states of completion and dependability. Furthermore, for complex programs, exhaustive testing is impossible, so one can never be sure that a program is really fully checked out. Thus we are faced with the problem of determining an arbitrary point at which it can be said that a program is *sufficiently* tested to be acceptable. A heuristic estimate of software lead time suggests that five to six years is reasonable. This estimate is based largely on the history of algebraic compilers and batch-monitoring operating systems.

One further consideration must be incorporated into any realistic prediction algorithm—that is, the rate at which the using community is willing and able to absorb technological innovation. In the past, machine generations have lasted about three years; for a variety of reasons they should last a bit longer in the future. Basic programming methodologies have tended to remain relatively constant through one machine generation for the majority of users.

Thus it is reasonable to make order-of-magnitude estimates about systems in use from five to 10 years ahead—1970-1975. This is the period in which the principal effects of batch-fabrication technology will first be widely felt. How big, how fast, and how cheap will information processing systems become in the early 1970's? And what will this do to programming technology?

how big?

Let us, then, examine the state of technological advance that will probably be exhibited by commercially available digital computing systems 10 years hence. This should also provide an indication of what may be expected in military hardware a few years earlier.

(Throughout this discussion the phrase "today's systems" will refer to those computing systems just now becoming obsolescent—i.e., 7094's, 1604's, etc.). We can expect primary stores in the hundred-million-bit range, some two orders of magnitude larger than those found in today's systems. Auxiliary storage systems span a wide range of parameters including capacity, access time, transfer time, and cost. It is difficult to find a single characteristic parameter, and the best we can do here is to suggest that a decade in the future there will be quasi-random-access stores with a capacity three or more orders of magnitude bigger than today's systems.

The biggest systems that will reasonably be built should have a performance level perhaps five orders of magnitude greater than today's systems, measured by problems solved per unit of time. Three orders of magnitude will come from increased raw speed, one from larger storage systems, and one more from increased sophistication of the logical structure of the machines. This last factor is the counterpart of the effectivity increase obtained from such features as built-in floating point arithmetic and hardware index registers. In the future this effect *may* come, in part, from content-addressable storage, but whence it comes is no matter, come it will. Finally, the cost of this 10^5 gain

do you make absolute binary patches to your compiled programs?

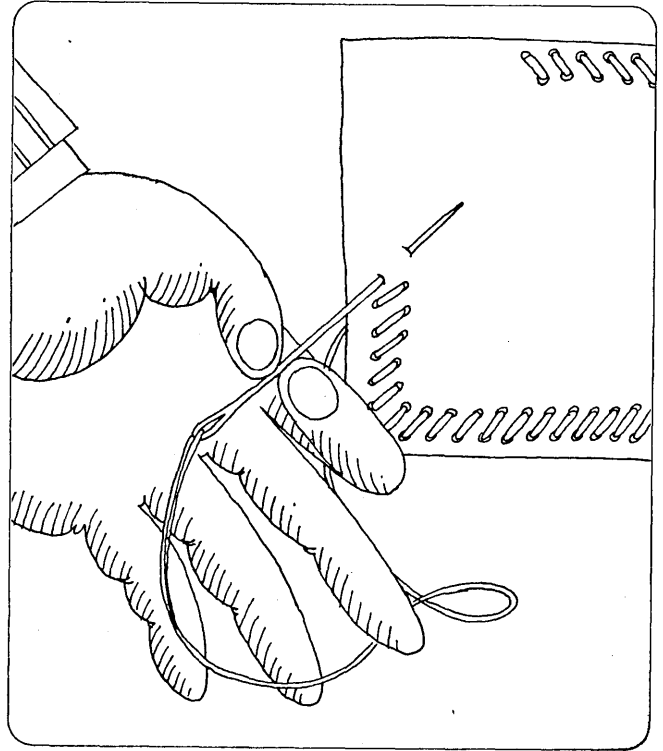

Burroughs B 5500 users don't.

It's never necessary. Burroughs B 5500 compilers are so fast and efficient, it pays to recompile for every change. Both the time required for modification and the chance of errors are greatly reduced. And it means you always have complete, current, standard documentation—in the COBOL, ALGOL, or FORTRAN original source language.

For more information about advanced compilers for the Burroughs B 5500, write us at Detroit, Michigan 48232.

Burroughs 

THE MARK OF EXCELLENCE IN EDP

CIRCLE 27 ON READER CARD

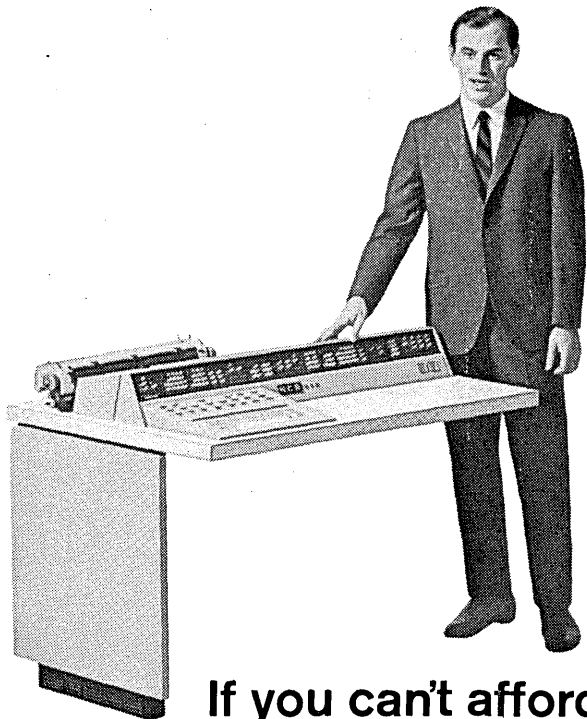

**If you can't afford to buy
a computer, buy part of one.**

It works just as well.



Try it. Chip in with other firms in your area and buy an NCR computer. You can all use it. It's being done by many banks and other businesses, all over the country that need the speed, accuracy and efficiency of electronic computa-

tion. Or rent time on an NCR-owned computer at your local NCR data processing center. Either way, you'll get the benefits of NCR's unmatched systems and service. Your local NCR man will help you make either arrangement.

N

C

R

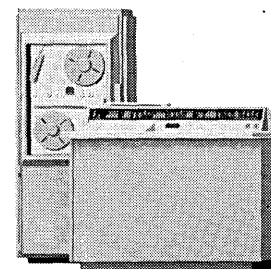

CHEAP COMPUTING...

in performance will itself be an order of magnitude *higher* than the cost of today's giant systems.

It is necessary to examine the above statement concerning cost with great care. The third word in the title of this paper is "cheap," and \$50-million machines hardly seem consistent with the ordinary meaning of the word. The point is, of course, that inherent in the suggested system is a potential for an increase of four orders of magnitude in problems solved per dollar. What we have is not cheap *computers* but cheap *computing*. The other side of this coin is the production of systems comparable to today's at one ten-thousandth the cost. There is probably a threshold effect that will prevent accomplishment of that objective. I doubt that a decade is enough time to put a 7094 into the price class of a color television set, *provided we insist on an individual and independent piece of equipment for each user*. Time-sharing in conjunction with the increased performance of very large machines promises to being the equivalent capability of a 7094 into just that kind of price class. This is an important point. In the absence of multiple users, there isn't much sense to be found in the idea of building gigantic \$50-million systems (with some exceptions unimportant to the general theme). Given the feasibility of multiple access systems, however, the large machines cry out to be constructed. It would be economic nonsense not to do so.

still room for others

The above remarks should not be taken as ruling out smaller, inexpensive systems altogether. Certainly if I could purchase a 7094 equivalent for the price of a Cadillac, I would be first in line at the Credit Union in the morning. Indeed, there are reasons for a whole range of intermediate systems. Conservatism, lack of communications facilities, or a requirement for mobility could lead a particular user to insist on an independent system. However, the two principal programming problems created by the availability of inexpensive hardware can be more clearly illustrated by large systems. Accordingly, the remainder of this discussion will examine the programming problems characteristic of an environment that presents the user with a widely varying fraction of the capabilities of a machine that is enormous by today's standards.

On the one hand, a casual user will be able to ask for calculations that would have required more than a human lifetime to complete only a score of years ago, and, use charges aside, will receive change for a penny when he pays his machine-time bill. At the other end of the scale, if he is willing to pay for them, the user may obtain solutions to problems that are, in some sense, 100,000 times as hard as today's hardest. This is such a broad spectrum of problems that the difficulties described below will obtain even if the performance estimates given above are generous by a couple of orders of magnitude.

Each of the extremes points directly to one of the two dilemmas faced by programmers when confronted with such a system. For a wide range of today's problems—and, thus, for the kind we might expect at the low end of the demand spectrum tomorrow—the cost of preparing the program is approximately equal to the cost of the machine time for running that same program. Making the cost of running the program infinitesimal only halves the total cost if programming costs remain unchanged. If total costs are cut only in half, there will not be the dramatic increase in users that is absolutely essential if the capital investment in very large systems is to be justified. Thus, in order for these large systems to be viable, it is

how often
do you use the
"start" button
on your computer?

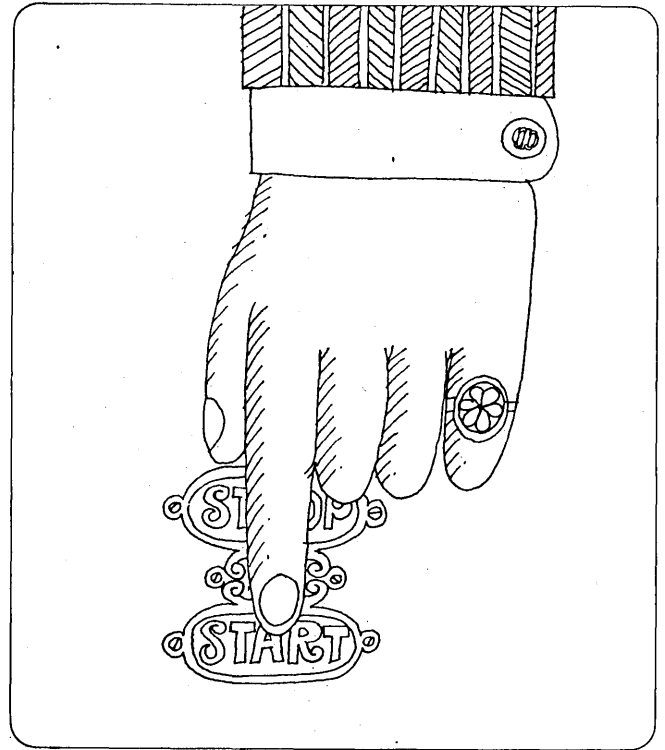

Burroughs B 5500
users never do.

There isn't any "start" button on the Burroughs B 5500. Just load the system when it warms up first thing in the morning. From then on, the Master Control Program takes over. It's constantly looking for more things to do, asking itself whether there are more programs ready to be run, or I/O units free, or open units of core memory available for more work. With such an advanced operating system, who needs a "start" button?

For more information about the Master Control Program for the Burroughs B 5500, write us at Detroit, Michigan 48232.

Burroughs 

THE MARK OF EXCELLENCE IN EDP

CIRCLE 29 ON READER CARD

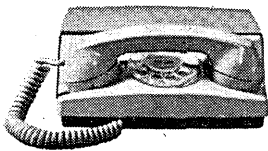

Navajo Freight Lines takes the shortest route to faster billing

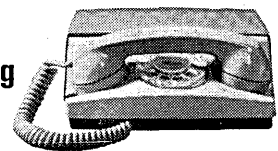

Navajo Freight Lines, Inc., uses Bell System Data-Phone* service to speed some 4000 bills a day.

At originating terminals, freight bills are cut on 35 ASR teletypewriter machines. Copies of the bills and an 8-channel by-product tape are produced simultaneously.

The tape is then transmitted over telephone lines at 1050 words per minute (or a bill every 3 seconds) to destination terminals and to Navajo headquarters in Denver.

At the destination terminals, tapes are inserted in 35 ASR teletypewriters which produce delivery copies of the freight bills:

At the same time in Denver, tapes are processed through a magnetic tape converter direct to computers which check for accuracy and produce copies of bills for preaudit.

This operation has made substantial savings for Navajo Freight. Billing steps have been reduced from 10 to 4. Accounting now takes just 2 days instead of 8. Current revenue figures are always available to Navajo management within 24 hours.

Find out how Data-Phone service can work for your data systems by talking with one of our Communications Consultants. Just call your Bell Telephone Business Office and ask for his services.

*Service mark of the Bell System



Bell System

American Telephone and Telegraph and Associated Companies

essential that the cost of programming and checking out a program be greatly reduced.

Now let us examine the difficulty at the other end of the scale. A naive view of the situation suggests that it presents an ideal world for the programmer. Freed from the present limitations on speed, capacity, and the tightness of code demanded by the high cost of machine time, the programmer should easily be able to meet any requirement levied by a system designer. There is an element in this observation that is true, of course, and it leads back to the point made above—i.e., programming costs will heavily outweigh machine-time costs. Where this is the case it is an error on the programmer's part to devote any time to producing efficient codes, since his own time is so much more valuable than the machine time he saves. Nevertheless, this point of view neglects two very significant facts. As machines get bigger, faster, and cheaper the system designer loses his inhibitions at a proportional rate. The programmer is invariably asked to do more than the available equipment will permit.

big problems for big machines

In order to forestall objections that there aren't any useful problems that would tax my postulated big machine, let me cite three such problems from different fields. I want to emphasize that each of the following problems is an integrated unit, *not* factorable into a collection or a sequence of independent problems.

Consider a system of 10^{11} gravitating mass points, externally perturbed, embedded in a turbulent fluid, and subject to an irregular magnetic field. Trace the behavior of this system over more than 10^6 integration steps in sufficient detail to account for the behavior of local systems of a dozen or so of the mass points throughout the entire integration span. This is approximately the problem that must be solved—highly oversimplified—to account for certain observed astronomical phenomena. This problem is too much for the largest system mentioned above, but useful simplifications would bring it into the scope of the system *if the necessary programs could be written*.

Consider next the development of a detailed simulation model of the national economy, disaggregated to the level of individual producers and consumers. As in the previous case, sufficient simplifications can be made to fit the constraints of our equipment. But the fact that a program will fit the machine does not guarantee that it can be written.

The third out-of-bounds problem I want to mention is the on-line, real-time war game. There are many military situations where it would be extremely desirable for the commander to have the ability for simulation of several games based on alternative strategies prior to making irrevocable decisions. The speed of modern war is such, however, that even the fastest machine we envision here is quite inadequate in many cases. And even in the cases where time would permit we must raise the same question as before: can the necessary programs be written?

Each of these examples illustrates the point made above; there are useful problems beyond the scope of the biggest equipment we can imagine existing 10 years hence. These are problems we can think of today. Give the system designer 10 more years to dream, and the situation can only become worse.

These same three examples also illustrate the second of the two facts neglected by the naive viewpoint about programming very large machines. In each case, one can

would you have to
reprogram to add
more memory to
your computer system?

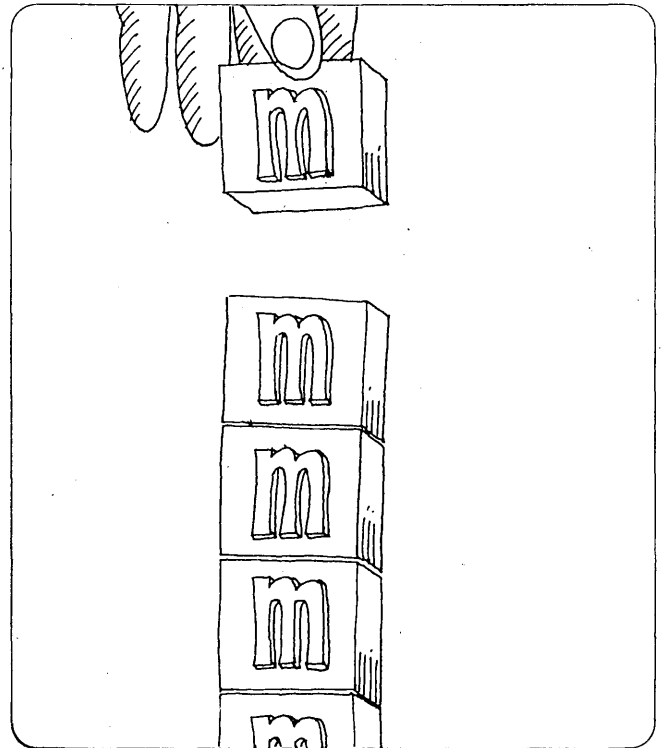

**Burroughs B 5500
users don't.**

They don't even have to recompile. The Burroughs B 5500 constantly monitors its own configuration, and will run programs with whatever memory size is available at the moment. B 5500 programs are totally machine-independent. The same program probably won't use the same memory locations today that it used yesterday. The addition or deletion of a memory module simply makes no difference other than its effect on running times.

For more information about dynamic system modularity of the Burroughs B 5500, write us at Detroit, Michigan 48232.

Burroughs 

THE MARK OF EXCELLENCE IN EDP

CIRCLE 31 ON READER CARD

SEE OUR EXHIBIT AT THE WESCON SHOW, AUGUST 24-27—SAN FRANCISCO

NEW MICRO SWITCH KB makes it practical for you to customize any keyboard or panel

KB gives you a complete new set of modular switch/display keyboard components—makes it practical for you to design and assemble a custom man/machine interface for each individual keyboard. KB is a totally new concept in panel design with *modular* components like these:

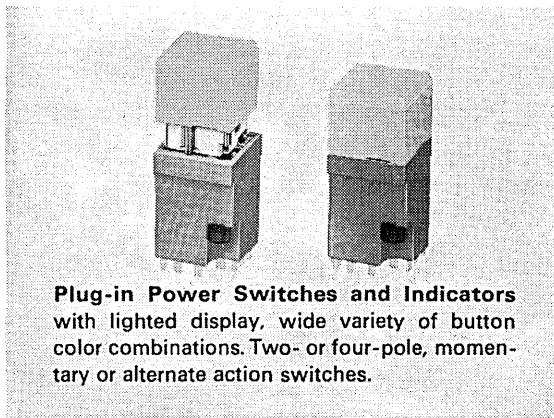
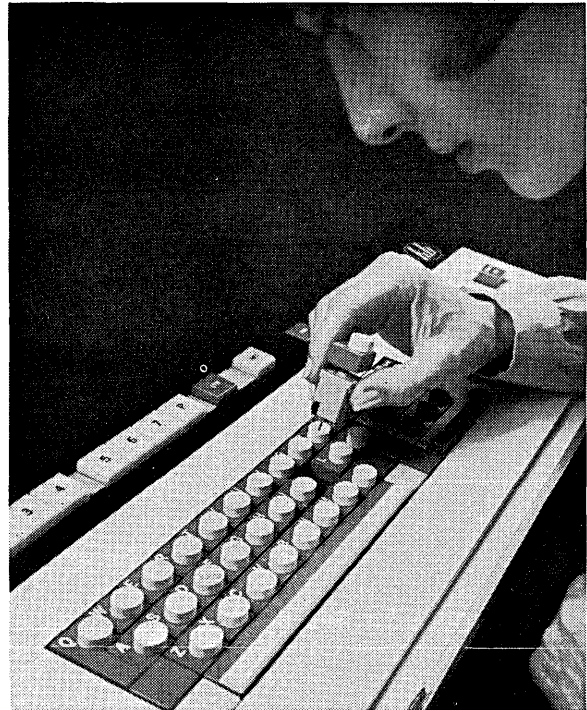

Plug-in Power Switches and Indicators with lighted display, wide variety of button color combinations. Two- or four-pole, momentary or alternate action switches.

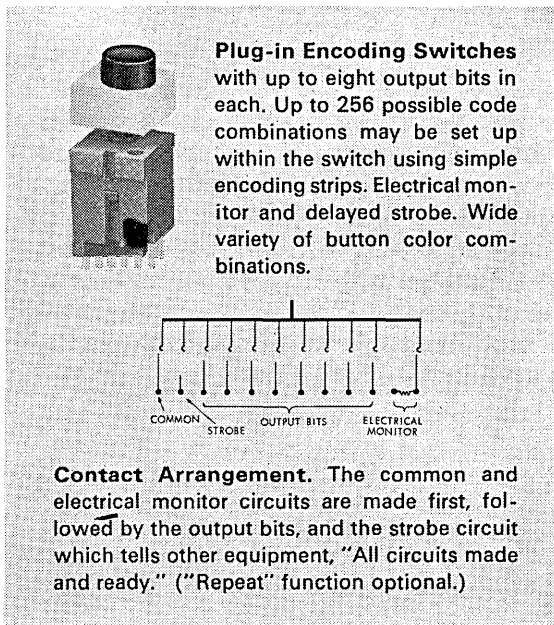

Plug-in Encoding Switches with up to eight output bits in each. Up to 256 possible code combinations may be set up within the switch using simple encoding strips. Electrical monitor and delayed strobe. Wide variety of button color combinations.

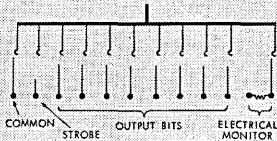

Contact Arrangement. The common and electrical monitor circuits are made first, followed by the output bits, and the strobe circuit which tells other equipment, "All circuits made and ready." ("Repeat" function optional.)

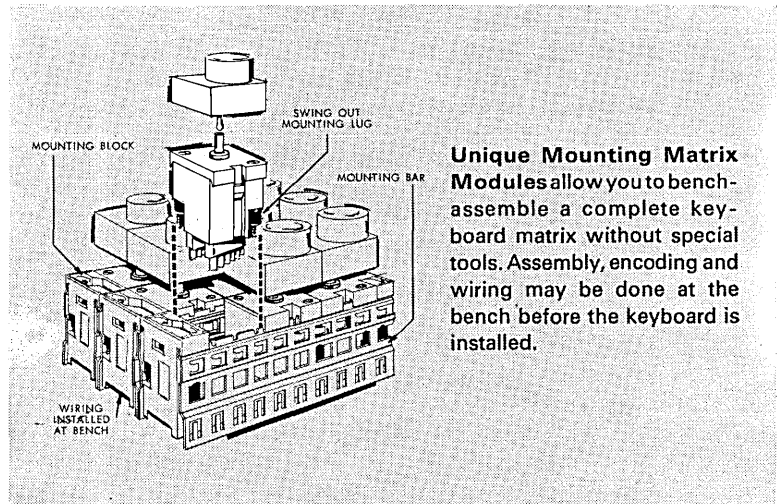

Unique Mounting Matrix Modules allow you to bench-assemble a complete keyboard matrix without special tools. Assembly, encoding and wiring may be done at the bench before the keyboard is installed.

For the first time, KB allows you to arrange all switches and indicators in only *one* panel cutout. You can now do all your encoding at the switches. Plug-in or lift-out switches without disturbing adjacent units. Use *modular* interlock components for bailing or lockout systems.

KB now makes it practical for you to customize every keyboard or control panel. KB saves on engineering time, tooling costs, assembly costs, panel space and weight.

Call a MICRO SWITCH Branch Office for a demonstration. Or, write for literature.

MICRO SWITCH

FREEPORT, ILLINOIS 61033

A DIVISION OF HONEYWELL

IN CANADA: HONEYWELL CONTROLS LIMITED, TORONTO 17, ONTARIO

raise the question about the feasibility of writing the necessary programs in the event that the problem is trimmed to a size small enough to fit the equipment. The reason for this is quite simple. For any given level of software technology, there is an ill-defined, but nevertheless real, upper limit on the number of instructions that a program can contain. Programmers can only generate and check out code at a rate that is commensurate with the available tools. Furthermore, this rate is a decreasing function of the number of programmers who must interact in producing the final program; adding more and more programmers leads to a point when nearly everybody has to spend most of his time finding out what the other fellows are up to. The only constrained variable left in this equation is elapsed time; and for almost all interesting problems, the nature of the problem itself evolves. Thus there comes a point at which the problem is changing faster than it can be programmed.

program size limits

In the era of absolute machine language coding, a few thousand instructions was about the limit. The symbolic assembly program has been used to construct a program of over a quarter of a million instructions; but this program very nearly remained uncompleted due to the evolving-problem phenomenon mentioned above. The use of macro instructions may permit slightly bigger programs to be written, but not enough to matter. Algebraic languages have been used to construct programs of several million words, and the limit of this approach has not yet been reached. As a guess, I would say that a 10 million-instruction program is about as far as one can go with present languages. Curiously, and almost certainly coincidentally, this upper limit on the number of instructions has roughly paralleled the number of *bits* in available primary stores. Using this figure as an estimator, we can infer that the big machines of a decade hence will support programs of some 100-million instructions. Casting a programmer's eye on the cut-down version of the three sample problems cited above, this size doesn't seem to be out of line with the requirements.

There is already some evidence that on-line debugging with interactive executive systems will be an important aid in reducing debugging elapsed time. This improvement is not enough, however. The inescapable conclusion is that some new way of describing programs must be devised that permits an order-of-magnitude improvement in the speed and facility with which programs can be written. This, of course, is the same conclusion that was derived from the difficulty encountered at the other end of the problem spectrum.

it can be done

There is an answer to this problem. First, due to the complex procedures now required to describe problem solutions to machines, it is necessary to have programmers as intermediaries between the real user and the machine. Thus the user must overcome the man-to-man communication barrier. Secondly, because of the detail with which the solution must be described, the programmer must spend a great deal of time preparing and checking out his programs. As noted above, there is an upper limit to the size—and, thus, to the complexity—of a program. It seems likely that this upper limit is dictated largely by the fineness of detail that is called for by the available programming languages. Here is where the barrier must be broken.

And here I state the key point in this paper. We know

do you have to wait to get a little job run on your big, busy computer?

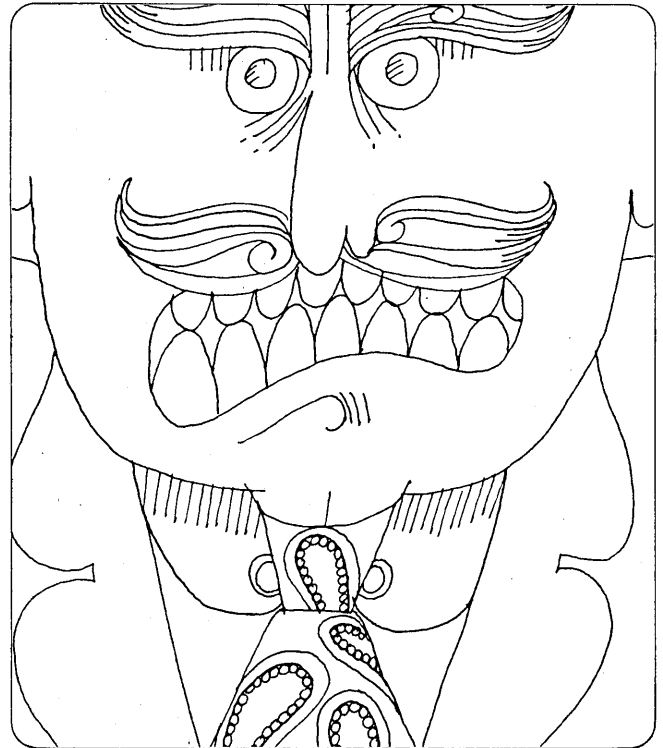

Burroughs B 5500 users don't.

With its multiprocessing capabilities, the Burroughs B 5500 takes on little jobs non-stop, while long runs continue uninterrupted. If you are ready with another job, big or little, just tell the system. The B 5500 automatically adjusts its schedule, fits in little jobs right away, bumps programs back in the schedule if a major new job has a higher priority.

For more information about multiprocessing with the Burroughs B 5500, write us at Detroit, Michigan 48232.

Burroughs 

THE MARK OF EXCELLENCE IN EDP

CIRCLE 33 ON READER CARD

ATTENTION: Los Alamos; we apologize for the Mag tape.

SDS CASE HISTORY No. 256:

Recently, an SDS 930 computer was installed at Los Alamos Scientific Laboratory, Los Alamos, New Mexico. It was put through a test to end all tests. Here's the story:

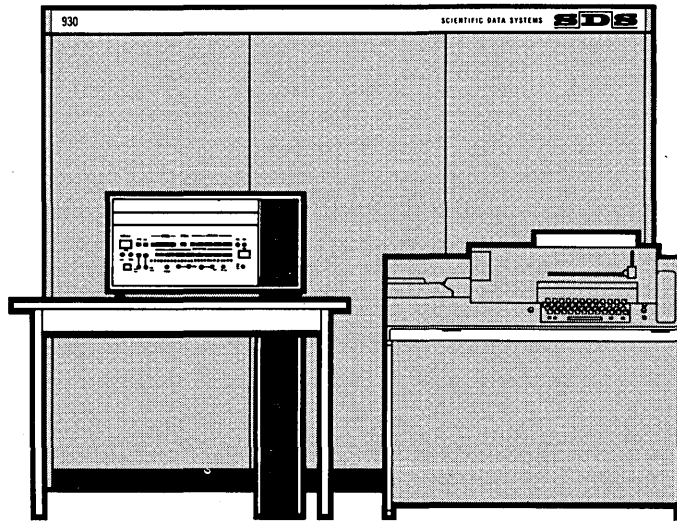

LOS ALAMOS SCIENTIFIC LABORATORY TEST CRITERIA:

There were seven phases to the Los Alamos Scientific Laboratory test:

1. The tests were to run for 40 hours with no failures; if a failure occurred, the 40 hours would start over.
2. Preventive maintenance was not to exceed 15 minutes each day, and was limited to the cleaning and lubrication of mechanical equipment.
3. Magnetic tape was to read or write a total of 864-million characters with no unrecoverable errors (accomplished by 10 full reel passes at 200 bpi, 10 passes at 556 bpi, and 30 passes at 800 bpi).
4. The typewriter was to output 216,000 characters with a maximum of four errors and no failures.
5. The paper tape reader was to read one-million characters without error (accomplished by reading 10 full reels of punched paper tape).
6. The paper tape punch was to punch 800,000 characters without error (accomplished by punching 8 full reels of paper tape).
7. Prior to, and after the test run, the system was to be

run on marginal voltage, each supply +10% and -10%. Also, diagnostics had to be run at worst-case settings which were +4V down 10%, +16V up 6% and -16V varied from -6% to +6%.

TEST RESULTS:

Over the full test, there was only one problem: A single unrecoverable error. Always the same error. Always on the same reel of magnetic tape. A microscope told us why: The magnetic coating was separating from the tape. So we substituted a new reel. End of problem. End of acceptance test.

ABOUT THE SDS 930:

The computer that passes the LASL torture test has a 3.5 μ sec add time, a 7 μ sec multiply time and a 1.75 μ sec memory cycle time. It has one standard buffered input/output channel. It also has as many optional buffered I/O channels as you need. All channels can operate

simultaneously with computation. And, since the 930 is an SDS 900-Series computer, it shares complete program and peripheral equipment capability with all other SDS computers, utilizes only silicon semiconductors, has floating point and multi-precision capability, and comes with a complete software package (including FORTRAN II and ALGOL).

WHY WE WON'T DO IT AGAIN

The LASL test was unique. It tested our nerves more severely than it tested the computer, and, frankly, we wouldn't go through that experience again. There is no need to: We proved that an SDS 900-Series computer is built to exceed by far all normal performance parameters. Our customers like it that way. They get more than they ask for and pay less than they've come to expect. That's worth looking into, isn't it? A good way to start is to write for our latest 900-Series brochure. A better way is to pick up the phone and dial our nearest sales office.

SDS

SCIENTIFIC DATA SYSTEMS, 1649 SEVENTEENTH STREET, SANTA MONICA, CALIFORNIA

Sales offices in: Albuquerque, Anaheim, Boston, Chicago, Cocoa Beach, Dallas, Denver, Detroit, Houston, Huntsville, Los Angeles, Philadelphia, Pittsburgh, San Francisco, Seattle, St. Louis, Washington, D.C. Foreign Representatives: CITEC, Paris, France; International Systems Control, Ltd., London, England, Sydney, Australia; Kanematsu, Tokyo, Japan; SDS, Ottawa, Canada.

exactly how to do this today. Nothing has to be invented; no breakthroughs are required. The crux of the matter is a system of very generalized, integrated subroutines. One requires generalization to meet the first difficulty. Generalization is the key to instructing the machine at a much higher level of aggregation than is now possible. These generalized routines exist now in a few cases, and their value is evident. For example, it is a great deal simpler to explain to a nonprogrammer how the COBOL SORT verb works (even though this is a great deal more complicated than it need be) than it is to detail the bit-chasing involved in an ALGOL procedure performing the same function.

Consider another example, this time mathematical. Programs exist today that perform analytic differentiation, and programs (or at least algorithms) are also available that optimize approximation coefficients. From these, provided the output of the first is in a form suitable for input to the second, it is not difficult to construct a routine that will take an arbitrary function, defined in terms of other functions known to the system, and generate a routine that will provide numerical values of the function. If this routine saves the original inputs, a mathematician can simply give a series of definitions and end up with a program to evaluate a whole set of functions.

One could multiply these examples for hours: report generators, generalized file maintenance and retrieval programs, generalized display formatting routines, n-dimensional array manipulators, etc. With sensible input and output conventions and communications standards, most of the detail in ordinary programs would be made implicit in the background program. All that remains is the language problem.

The language problem is also soluble, albeit not as easily. Some human-engineering study is required to determine the optimum mix between learning requirements for the users and program slowdown due to exhaustive analysis by machines. Parsing programs and ambiguity resolvers have almost brought the natural language input program into being.

Of course, the question that comes to mind at once is: "If it's all that simple, why isn't it being done today?" The answer is, it is being done experimentally; it isn't being done operationally because it costs too much. If we increase machine performance by several orders of magnitude, however, we can afford to give one order of magnitude to achieve all these things. We are certainly going to be willing to pay a dime instead of a penny for machine time if it takes us only 10 minutes instead of 10 hours to write our program.

Given the performance increase, the rest will follow without question, although initial acquisition of the capability will be a rough job because we have to start with today's tools. Once the generalized and integrated systems begin to take shape, improving them will become progressively easier as we use them to bootstrap their own evolution. If batch fabrication and other aspects of advancing hardware technology can provide the reliability, speed, and capacity that seem promised, then this brave new world will be, indeed, the programmers' heaven; but the programmers who glory in it will be the people we now call "users." The descendants of today's programmers will still be chained in the other place trying to provide the generalized and integrated capability needed to cope with the still-overexuberant system designer whose ambition knows no bounds. ■

PROGRAMMERS SYSTEMS DESIGNERS

We need men with creative ability and experience for our computer systems & planning department.

7070/1401 installed

Two additional 360 systems with disc storage to be installed next year.

The department is in the process of converting its business applications to systems 360 leading to the design and implementation of a total information system. If you desire to become an integral part of the company's management systems organization, this is a genuine opportunity for rapid advancement and technical challenge for years to come.

Write: Mr. J. L. Porter
Vice President
**THE NORTHERN TRUST
COMPANY BANK**
50 South LaSalle St.
Chicago, Illinois 60690

An Equal Opportunity Employer

CIRCLE 90 ON READER CARD

COMPUTER SCIENTISTS

Our client, one of New England's foremost engineering organizations, has an immediate corporate mandate to develop an outstanding SPACE-BORNE Computer Department. KEY Managers are required NOW to spearhead the development and applications of these computer systems;

DEPARTMENT MANAGER

Will direct the development of Space-borne Computer and Control Systems . . . studies, proposals, and customer presentations . . . support marketing activity. Advanced degree in EE or Physics desired. Strong background in Digital Systems . . . Logic, Circuit, and Memory Design required. Salary: \$25,000-\$30,000

SECTION MANAGERS

Head conceptual teams to design special and general-purpose computers as applied to: Detection, Data Processing, Navigation, and Fire Control Systems . . . Man/Machine or Computer Interface Techniques . . . Devices. Advanced degree in EE or Physics desired with broad systems/hardware experience. Salaries: \$18,000-\$25,000

DESIGN ENGINEERS

• Digital • Analog • D/A-A/D Conversion • Logic • Systems • Memories • Peripheral Equipment • Integrated Circuits. BS or advanced degree in EE or Physics.

Employer assumes all costs and our service charge.

Immediate details available in CONFIDENCE by calling COLLECT or submitting resume including current earnings to:
D. G. STUART, Technical Director

Snelling AND Snelling

CALL COLLECT NOW!
(617) 262-2669
For 24-Hr. Service

EDP Staffing Specialists
581 Boylston Street, Boston, Mass. 02116

An Equal Opportunity Service

CIRCLE 91 ON READER CARD

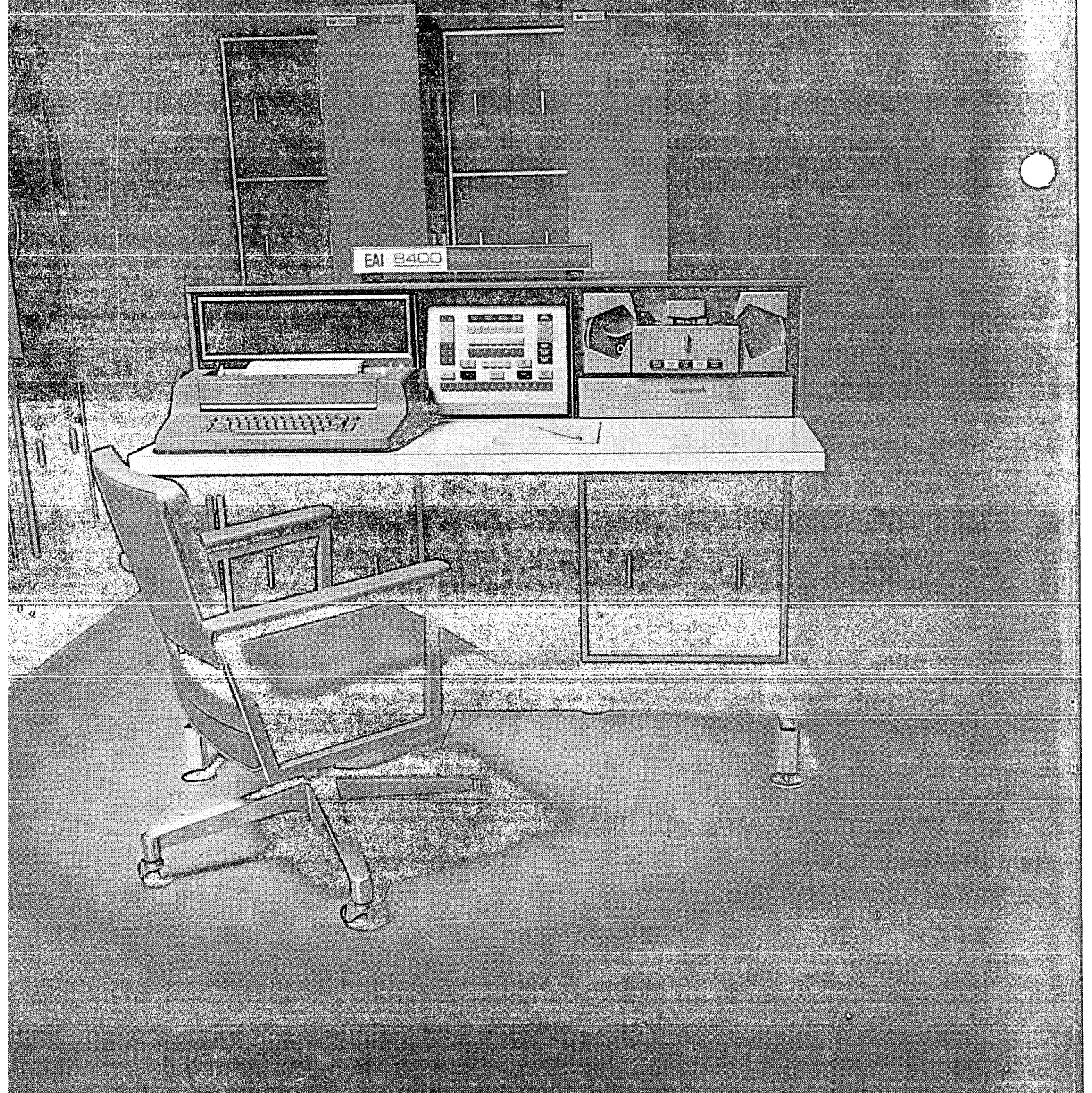

IS HE MAKING OFF-LINE CHANGES? . . . NOT WITH THE EAI 8400.

Effective computer simulation requires the ability to make changes on-line to your mathematical model. With the difficulties inherent in using your digital computer's binary language, you are probably making changes off-line with costly reassemblies. Not so, with the EAI 8400 Scientific Computing System. Chained symbol tables permit changes to be made on-line in the user's own symbolic terms. Regardless of what changes he has to make, he can completely recover his program in symbolic language. Disassembly, a new concept from EAI, reconverts the model in memory to a relocatable symbolic language output — complete with all linked subroutines. A listing in the original symbolic terms documents the revised program. And . . . strict program sequence is maintained by Dynamic Storage Re-allocation which automatically opens or closes the program as changes are made. This is another example of how 15 years of experience in simulation enables EAI to combine its creative software and advanced hardware in solving tomorrow's simulation problems today. . . . Write for full details.

EAI
ELECTRONIC ASSOCIATES, INC. West Long Branch, New Jersey

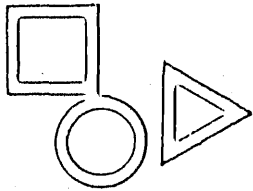

WORLD REPORT

FRENCH, U.K. FIRMS NEAR AGREEMENT

As predicted on these pages (May, p. 63), preliminary proposals for Anglo-French cooperation in the development and marketing of computers are expected as this is being written. Discussants are Britain's ICT and France's CITEC, part of the CSF electronics group. And points believed on the agenda include the licensing of CSF to make and market ICT 1900's on the Continent and joint work on large systems, particularly for the military and scientific markets.

DEFENSE: BIG BUSINESS IN EUROPE TOO

President de Gaulle's attitude toward NATO and his desire to build a home-based technology (see above) may have repercussions on the multi-megabuck NADGE contract if, as seems likely, he withdraws French participation in the attempt to provide integrated European air defense. The four-year operational target date may be delayed even more. Still, Europe remains a lucrative defense market.

Belgium, W. Germany and Holland have chosen Hughes' Tactical Air Weapons Control System to meet their air defense needs until NADGE comes along. Chosen by Japan last year and Switzerland a month ago, the systems will include computers, displays and communications gear. The Swiss will place a \$3-million contract with Ferranti for data links for their system, "Florida."

Last month, Britain unveiled a \$150-million national air traffic plan called Mediator, due for completion in '69. About a third of the contract, for computers and such, goes to Ferranti and AT&E, part of the Plessey electronics group. AT&E has developed a range of computers, the XL series, for message switching and traffic control applications.

WESTERN COMPUTERS GO TO EAST EUROPE

Eastern bloc countries are providing a rapidly expanding market for British firms. Elliott Automation will install a \$750,000 503 system at the Czechoslovak State Computing Centre, Kancelarske Stroje, for general scientific work. It will include a 40K-word memory and five slow and fast tape drives. Two smaller 803 machines are already in use at the Czech Centre, and three more are installed in manufacturing plants. The 503 is the first of orders totalling some \$5 million expected to be placed with British firms, according to the Czech commercial attache in London.

Elliott is also supplying \$150K Arch computer for direct digital control of a gas fractionation plant to be built in Russia. Prime contractor is SNAM Progetti of Milan; this will make the sixth Arch system for Russia for on-line control. ICT also expects more orders from Iron Curtain countries.

BURROUGHS COMPUTER SALES RISE IN EUROPE

Of the main groups of machine makers operating in Europe, Burroughs seem to have religiously steered off computer sales. First serious signs of activity, however, came last year as the sales force began converting existing EAM customers. With some 30

When the job is too big for this...

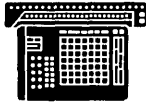

and this is too big for the job

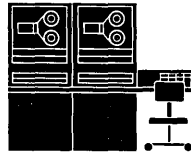

The WYLE Scientific
More than a calculator—Almost a computer
... with unlimited, externally-stored
automatic input
for less than \$5000

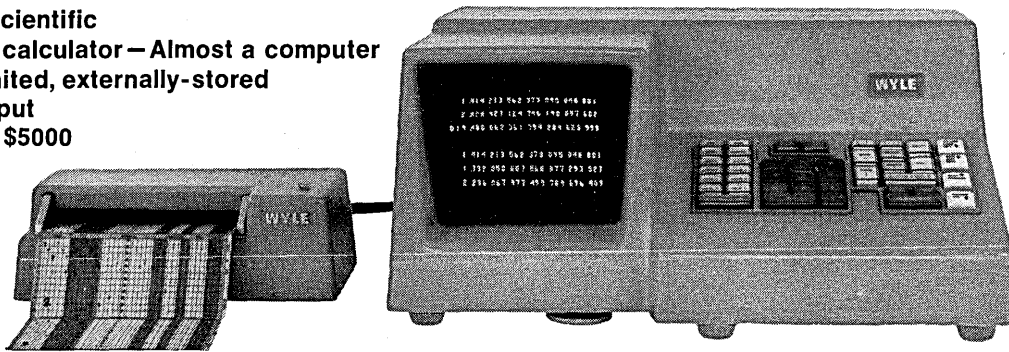

WORLD'S MOST ADVANCED
 DESK-TOP COMPUTATIONAL CENTER,
 the WYLE *Scientific* offers almost unlimited application in the solution of complex scientific, engineering, and statistical problems. Yet it is easier to operate than a calculator; takes up about the same desk space as an electric typewriter; solves problems with speed approaching that of a computer; operates with the quiet, and reliability of all-solid-state electronics. And its cost amortizes over a three-year period at less than \$1 per working hour.

THE ONLY DESK-TOP MACHINE
 WITH UNLIMITED STORED-PROGRAM AUTOMATIC INPUT,
 it eliminates all the wasted time of multi-step repetitive problem solving. It can be programmed with a ballpoint pen to perform all your recurrent computations automatically, regardless of length, through its card reader. Typical calculations you can program include the development of any trigonometric functions; any exponential functions; statistical analysis; $\log_e x$ and $\log_1 x$; antilog x ;

radix conversion; cube root; polynomial evaluation. For *any* program, you simply punch in your instructions by hand on a Wyle stored program card, which has the *Scientific* keyboard reproduced on it, and enter the variables through the manual keyboard. No computer training, "language," or special equipment is needed to develop a complete library covering your repetitive formulas. Any number of cards can be taped together to feed continuously into the reader the lengthiest computations. And *preprogrammed* Wyle cards are available covering a wide area of problem solutions.

AS A COMPLEMENT TO DIGITAL COMPUTERS,
 the *Scientific* is effectively used for computer program formulation and checkout. It is particularly valuable when determining the requirement for double precision programming. Program checkout on conventional calculators is very time consuming, and failure to properly check out programs can waste expensive computer time. The features of the Wyle *Scientific* make it indispensable for increasing the productivity of computer oriented staffs.

NEVER BEFORE CAPABILITIES LIKE THESE

The contents of all registers are displayed, on an eight-inch cathode ray tube, as indicated below.

0 000 000 000 000 000 495 582 441	Multiplier-Quotient Register
000 000 008 512 000 000 000 000	Entry Register
000 000 000 000 000 495 582 441	Accumulator Register
000 000 000 001 414 213 562 373	Storage Register 1
000 000 000 001 732 050 807 568	Storage Register 2
000 000 000 002 236 067 917 499	Storage Register 3

All parts of a problem are visible. The contents not only of the three active arithmetic registers, but also

of the three storage registers are displayed at all times. Numbers entered from the keyboard are seen as they are entered and can be verified before use.

Transcription errors are eliminated through complete versatility of transfer from any register to any other without loss of desired data.

All registers handle 24-digit numbers to provide extreme numerical precision.

Decimal points are entered as they occur in the numbers, using an eleventh key, and all input and answers are correctly aligned with decimal point on the output display.

Automatic square root is provided, as is single entry squaring.

These capabilities, combined with stored program

automatic entry, for the first time fill the technical and economic gap between calculators and computers.

Cost of the *Scientific*, complete with automatic input reader, is less than \$5000. This cost amortizes over a three-year period at less than \$1 per working hour.

For further information, write Dept. Y, Wyle *Scientific* Sales, 339 South Isis Avenue, Inglewood, California. Or phone OR 8-5671.

THE WYLE Scientific
 a product of **WYLE LABORATORIES**

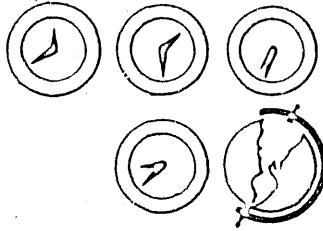

NEWS BRIEFS

MARTIN GOES FOR THREE PAIRS OF GE 635'S

Martin Marietta's Martin Co. division has signed up for six GE 635's, matched pairs for three installation sites—Denver, Baltimore, and Orlando, Fla. The complete package will come to around \$12 million.

Each dual system, set up for time-sharing later, will have 112K core, 20 tape units, and assorted discs, drums, and terminals. Plans call for putting all scientific, engineering, and business functions on the dual-processor systems.

Denver is first in line, expecting their equipment in November of this year. The other plants will be close behind, with everything due to be in by February of next year.

A MANAGEMENT SYSTEM FOR THE LOCAL MERCHANT

A packaged retail management system, ranging from optical printing cash registers to computer-generated reports, has been demonstrated by NCR. Target is the small retailer.

The merchant with a one-cash-register store is being offered the special register and a batch of management reports, the output of processing at an NCR data center, for \$200-300/month. The results include accounts receivable reports and statements, inventory and sales analyses, and profit/loss and income statements.

Held in Chicago, Los Angeles, and Washington, D.C., the demonstrations follow installation of 400 systems and orders for some 600 more. The system is being sold on an industry basis, and NCR has 25 data centers available to process the local input. Lumber, clothing, and drug stores have now been approached; bookstores are next.

MASSACHUSETTS SCHOOLS GET COMPUTER NETWORK

Five elementary and secondary schools in Massachusetts communities will be on-line to a Bolt Beranek and Newman computer, starting in September. More schools are to be added later. The program is sponsored by

the U.S. Office of Education with a grant of \$176,000.

Grade levels using the machine during a summer trial period are the sixth, ninth, and eleventh. The students have been provided with easily learned programming languages called Telcomp and Toll 1 and they can call on the computer to solve problems or play mathematical games. The trial period has been a hit with the children, who have lined up early in the morning for a chance at a terminal. Recently, one checked in at 6:58 a.m.

The program does not involve extensive work on programming but is intended for use as a part of the math curriculum for all of the students.

TWO FIRMS OFFER TIME-SHARING SERVICE

CEIR Inc. and Bolt Beranek and Newman are two more companies offering time-sharing service for scientific and engineering applications. The CEIR service, in the Washington, D.C. area, will go on the air in September with a 32K GE 225 and 16K Data-net 30 system which will accommodate up to 125 subscribers. Only 30 can use it simultaneously, however. Dartmouth-developed BASIC will be the language used.

BBN is offering its TELCOMP service in the Boston area, and will initially use its modified PDP-1. The language is a BBN-developed expanded ver-

IBM TRIES COMPUTER-ASSISTED INSTRUCTION ON OWN STAFF

A pilot study is being conducted by IBM's Field Engineering Div. to test the feasibility of using remote terminals for continuing training of customer engineers.

Model 1050 terminals in Philadelphia, Los Angeles, San Francisco, and Washington, D.C. are linked by telephone lines to a 1440 at Poughkeepsie, N.Y. Course material is stored on disc files. Student response set the rate of presenta-

tion of new material and performance of the students is analyzed, then stored for their records. For special questions, telephone subsets are available for conversation with an instructor at the computer site or another terminal.

Students get to talk back, too. They can ask to see a glossary of terms, skip an area by showing they already know it, or even complain about the course to the computer.

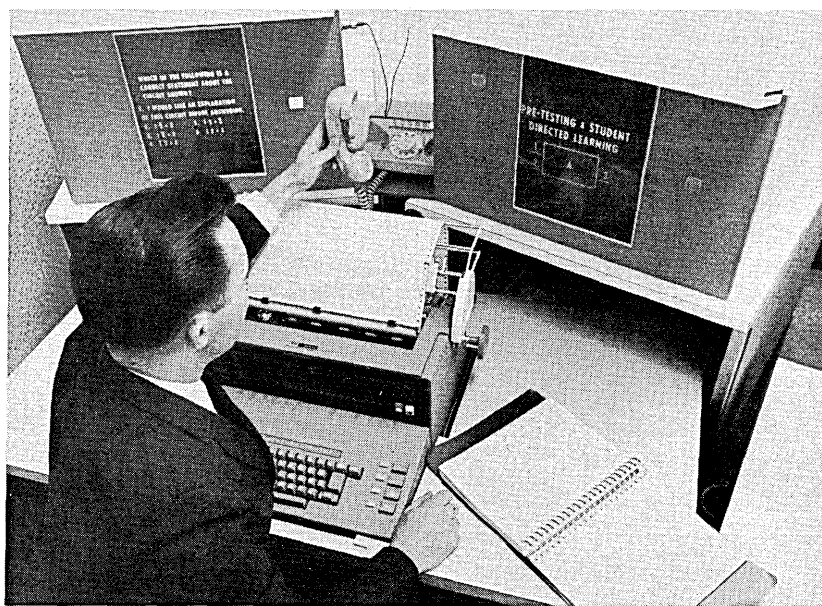



Now she reads information from stored computer records (or adds it)...instantly.

Suddenly... a clerk or teller has at her fingertips the ability for high-speed handling of business data. It took her only a few minutes to learn. The "missing information link" is provided by the new Stromberg-Carlson S-C 1100 Inquiry Display System. It is designed for banks, insurance companies, utilities, airlines and other organizations which must refer frequently to stored data.

Simple as a typewriter: When the operator receives an inquiry concerning an account or record she uses the keyboard to enter account number and appropriate computer

code. She then visually verifies the complete entry on the cathode ray tube screen. By depressing the "transmit" key, she sends the message to the computer memory in a fraction of a second — and the S-C 1100 immediately displays the requested data on the screen. Entries can also be made by the operator and added to the stored record automatically.

Multiple units: Over 400 of these desk-top units may be used to work with a centralized data processing system. Two models are available — one displays up to 100 characters; the other up to 500 characters.

Benefits include: Increase of computer efficiency, better budget and inventory control, reduction in external and internal telephoning, manpower savings, greater personnel efficiency and better morale because of faster availability of information.

For complete details on the new S-C 1100, write: Stromberg-Carlson Corporation, Data Products—San Diego, Dept. F-37, P.O. Box 2449, San Diego, California 92112.

STROMBERG-CARLSON
CORPORATION
DATA PRODUCTS-SAN DIEGO

NEWS BRIEFS...

sion of RAND's JOSS, also called TELCOMP, said to be an easy-to-learn interpretive system for arithmetic computation.

CEIR subscribers will pay \$250/month for 50 hours terminal use plus \$25/month for telephone lines and \$35-125 for teletype console rental. TELCOMP users will pay for computer time on a sliding scale from \$325/month for 25 hours to \$8/hour. Cost of terminal and communications (via TWX or telephone lines) will vary.

CDC ACQUIRES LIBRASCOPE BUSINESS COMPUTER ASSETS

Through an exchange of stock, Control Data has acquired the business computer operation of General Precision's Librascope. CDC took just about the whole works: rental and service contracts, computer inventory, and sales and service organization. Installations include over 400 LGP-21, LGP-30, and RPC-4000 systems.

General Precision will now concentrate on military, space, and special-application markets. The Librascope Group will continue its line of mass memories, especially the series of disc files for GP use and in the original equipment market.

WYLE LABS' APP-01 USED TO REJUVENATE 402'S

Under a half-million-dollar contract, Wyle Laboratories will supply DPA, Inc., of Dallas with its Programmable Arithmetic Processors to be fitted onto IBM 402's. The result is known as the DPA 4020 Punched Card Data Processing System and can handle arithmetic operations under control-panel program control.

Market for the 4020, according to Wyle, is the vast number of companies using 402, 407, 602, or 604 units who have outgrown these machines but are not yet ready for full-size computers. Deliveries of the 4020 are scheduled for September.

CIRCLE 187 ON READER CARD

NEW COMPANY TO MAKE SMALL COMPUTER

Logic Corp., established in River- ton, N.J. this spring, will begin manufacture this August of a small delay-line computer to be used as a classroom tool, desk calculator for scientific problems, and for inventory control and payroll functions. The LC system, which will sell for \$11.5-13.-

SYSTEMS RESEARCH GROUP, INC.

announces

MILITRAN

... a complete simulation language.

MILITRAN proves that a simulation language need not rob Peter to pay Paul. While providing object/class definition, automatic event sequencing, and extensive list-processing capabilities, MILITRAN expands general programming features to include sixty-character symbols, mixed mode expressions, unlimited subscript nesting, and ten-dimensional arrays with optional assignment of dimension sizes at load time.

An intensive one-week course in MILITRAN will be given during the week of October 11-15 at the Island Inn, Westbury, New York. The course fee of \$200 includes all texts and a copy of the MILITRAN system for the IBM 7090/7094.

Contact Mr. Robert Guest at

SYSTEMS RESEARCH GROUP, INC.

1501 Franklin Avenue

Mineola, New York

Telephone: 516-741-8970

CIRCLE 39 ON READER CARD



Reduce check inquiry costs 80%

Automation is only as fast as your system for using the data. Here's one example: Handling thousands of daily customer inquiries about checking accounts was a problem for a major bank in the Midwest. When computers were installed, checking account records were consolidated into two Acme Visible Centrac® units like the one above. Now inquiries are answered in seconds by 80 per cent fewer clerks who remain seated. Each Centrac gives instant access to 60,000 account cards and balance information updated daily on computer print-out sheets. Other Centrac systems are used by banks to keep pace with computer input and output.

ACME VISIBLE

ACME VISIBLE RECORDS, INC.
7508 Allview Drive, Crozet, Virginia

Please explain how Acme Visible Centrac systems can be custom-designed to solve paper-flow problems in our bank.

NAME _____ TITLE _____
COMPANY _____
ADDRESS _____
CITY _____ ZONE _____ STATE _____

CIRCLE 38 ON READER CARD

HIGH DENSITY
LOW COST
INTEGRATED
CIRCUIT PACKAGING
is now called



MicroSystem®

(There are 49 integrated circuits on the card above, interconnected, with room to spare!)

No longer is integrated circuit packaging a high-priced touchy production problem. Now there is MicroSystem®, the new concept in practical, reliable, and low cost I.C. assembly developed by Engineered Electronics Company. Just look at these advantages.

High Density—As many as 100 flat packs on a single 4x5 card.

Dependable—All welded fabrication, no IC lead bending required.

Versatile—Any flat pack desired, accommodates design changes without major cost or delay.

Fast Delivery—Only 2 weeks for MicroSystem® prototypes, 4 weeks for production.

Low Priced—A fraction of the cost of multilayer boards.

The heart of MicroSystem® is the "stick" element shown here. It is essentially a lamination of flat packs and conductor layers, welded and encapsulated into a finished, plug-in unit. The materials and processes used in assembly permit wide temperature operation. As many as 10 flat packs may be used in a single stick.

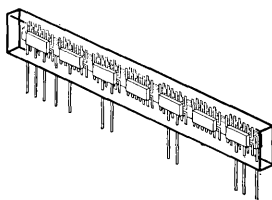

For details on MicroSystem®, complete with circuit layout vellums, write, wire or call...

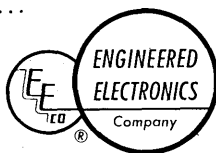

ENGINEERED ELECTRONICS Company

1441 East Chestnut Avenue, Santa Ana, California 92702
(714) 547-5651 • TWX (714) 531-5522 Cable ENGELEX

DESIGN LAYOUT VELLUMS



A layout vellum to simplify your MicroSystem® IC designs is yours for the asking. Easy-to-use, it also includes a detailed explanation of MicroSystem® construction.

See EECO MicroSystem at Wescon, booths 3113, 3114

CIRCLE 40 ON READER CARD

NEWS BRIEFS...

5K, is designated by memory size—LC-1000 to 8000 in increments of 1000. It features a 5-msec access time, 156 usec add time (exclusive of data access and storage of result), program interrupt capability, and about 80 silicon transistor circuit boards.

Included in the configuration will be a 33ASR Teletype or Dura Mach 10 (typewriter, tape reader, punch), and for scientific applications, two d-a converters. Any I/O devices commercially available, such as card reader, can also be adapted to the LC systems. Software available will include an assembler, a library of mathematical subroutines, special payroll package, and possibly FORTRAN, at a later date.

The company, headed by Henry Alken, formerly of RCA and Varian Assoc., has administrative offices in Philadelphia and is presently seeking a manufacturing plant in southern New Jersey.

● Information International Inc. is offering use of its PFR-1 programmable film reader system, including programs, to educational organizations at a "reduced rate" of \$50/hour. The researcher, says III, can expect to read, digitize, and record on magnetic tape over 5000 oscilloscope traces an hour. Users developing additional programs for the PFR-1 are expected to document and submit them to III, who will make them available to other users.

CIRCLE 188 ON READER CARD

● Systems Research Group of Mineola, N.Y., has made its MILITRAN simulation compiler available for general use. The language, developed under an Office of Naval Research contract, is designed to facilitate programming of large simulation models. It includes automatic event sequencing, object/class definitions, and extensive list processing facilities. Using 60 character symbols, it provides for mixed mode expressions, symbolic statement labels, n-dimensional arrays, load-time dimension assignments, and extended loop control statements. SRG will offer a one-week course for prospective users.

CIRCLE 189 ON READER CARD

● Sylvania Electric Products has an \$11.6-million Navy contract to build 59 shipboard computers, CP-642B/USQ-20 systems, whose basic design was originally developed for the Navy by Univac. The systems, to be pro-

On May 31st 90% of all regulated power supplies used in D.P. equipment became obsolete. The reason: Omnimod!!

A brash statement, but the facts support it.
FOR EXAMPLE:

A single OMNIMOD power controller module can supply any voltage between ± 2 and ± 60 v dc at 0-7 amperes **without modification or adjustment.** Plus and minus power control modules are available, if desired, to simplify some multi-output power supply systems.

High efficiency. Cuts input power needed to supply a given piece of equipment up to 40%, thus reducing overall cooling system requirements.

Want to change the size of your system? Add or take away a module.

All modules are interchangeable . . . no maintenance problems with the OMNIMOD.

Overvoltage protection? Remote sensing? Turn on/Turn off sequencing? Of course! And much more!

Let us plug one in and show what OMNIMOD can do.

Write, or call collect, and we'll have the full story to you within 48 hours.

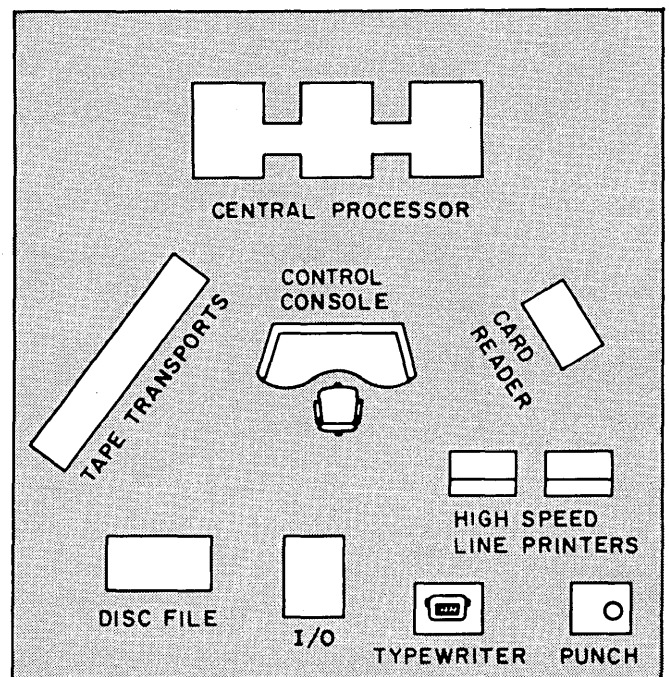

Every voltage in every element of this typical data processing system can be supplied with interchangeable OMNIMOD power supply modules.

CONTEMPORARY ELECTRONICS

128 North Jackson, Hopkins, Minn. 55343 Telephone 935-8481—Area Code 612

EXTRA SERVICE TO THE DATA PROCESSING INDUSTRY

CIRCLE 41 ON READER CARD

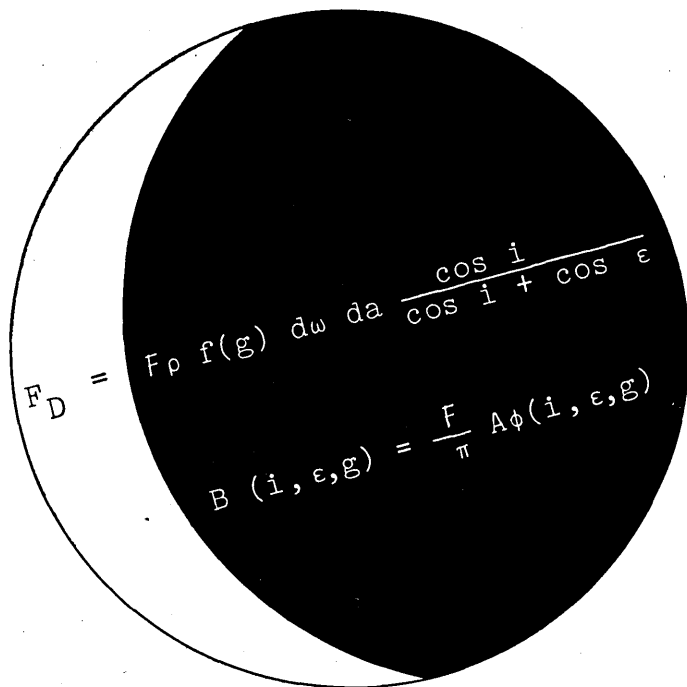

There's a beautiful problem out tonight

You might like our way of looking at the moon.

It's a different way, because our assignment is to do systems engineering for the National Aeronautics and Space Administration's manned space flight effort.

Getting to the moon and back is a series of problems which not only have to be solved—first of all, they have to be identified, defined, understood.

Bellcomm has rewarding openings right now for advanced thinkers in such fields as physics, mathematics, engineering, chemistry, propulsion, flight mechanics, computing and programming, guidance and trajectory analysis.

If you are highly qualified and experienced, your résumé will be welcomed by Mr. N. W. Smusyn, Personnel Director, Bellcomm, Inc., Room 1307-E, 1100 17th St., N. W., Washington, D. C. 20036. We are an equal opportunity employer.



Bellcomm, Inc.
A Bell System Company

NEWS BRIEFS...

duced over the next three years, will be used for processing data for the Navy Tactical Data System, which integrates anti-submarine warfare sensors, shipboard radar, and early warning aircraft radar. The Sylvania CP-642B's will be in addition to the Univac 642A's and B's now in use by the Navy. Characteristics of the system are 32K (30-bit) main memory, 64-word thin film control memory, and 64-word NDRO. It performs 125,000 computations/second.

- A \$44,977,000 contract for the design and fabrication of 1,017 terminal stations for the AUTODIN system has been awarded to the General Dynamics/Electronics Div. by the U.S. Army Electronics Command. The stations, to be located at military installations all over the world, will consist of high- and low-speed paper tape punches and readers, card punches and readers, page printers, teletype and typewriter terminals, and common control units.

- Elsewhere in the defense arena, Univac has announced a new computer, the 1230, 40 of which have been ordered by NASA for Project Apollo to summarize telemetry data and handle tracking and re-entry functions. (Thirty-five of these are included in previously announced NASA contracts totalling \$13.4 million.) The system can be used in a multi-processor configuration with the rest of Univac's military computers—the CP-642A and B, 1218, 1219, and CP-667. It has a 32K (30-bit) main memory with capability for expansion to 114,688 words, a 128-word thin film control memory, and a 64-word NDRO. Main memory cycle time is 2 usec, overlapped; control memory has 400-usec cycle time. Other features are 16 input and 16 output channels which can transmit 3-bit words in parallel at 500,000 words/second. I/O features are externally specified addressing and indexing and a continuous data mode.

- A project at the Univ. of Iowa is intended to detect heart defects by computer analysis of the sound of heartbeats. Using an SDS 92, the program calls for recording of the heartbeat patterns of all students at the school, followed by automatic analysis of the recordings.

New
Wright
LINE



permits tapes
to be
suspended



Storage capacity
is doubled . . .

Identification
is instantaneous . . .

And retrieval
is a simple push-grasp!

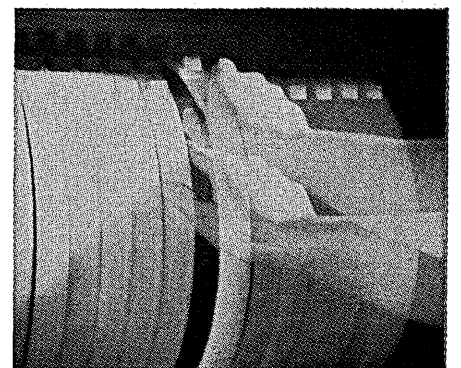
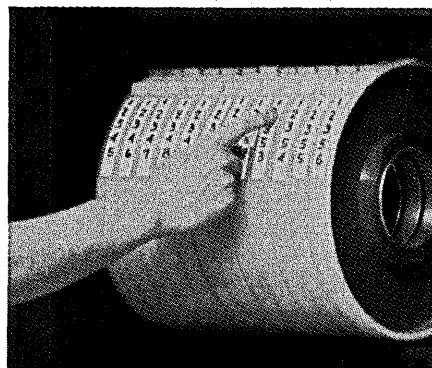
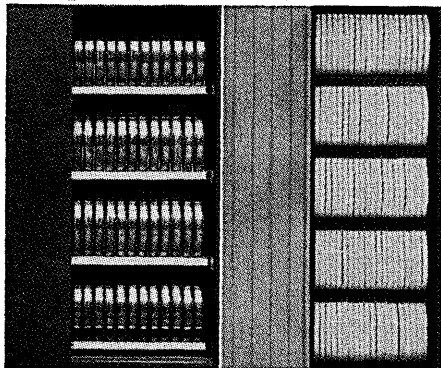

The new Tape-Seal Computer Tape Storage System can increase your present storage capacity as much as 100% while it minimizes tape damage and dust problems, and provides solid flange protection. The system revolves around a unique flexible polyethylene belt, which is wrapped tightly around the reel flange edges. Not only is the Tape-Seal Belt™ 90% lighter than a conventional container, but 45% narrower. The hook-latch device permits the tapes to be suspended, rather than seated between wire supports.

Permanent identification labels are automatically visible . . . always in the same spot. Because the belt hangs, Tape-Seal Cabinets store 200 tapes in the space 96 used to fill. To really appreciate the Tape-Seal Computer Tape Storage System, see a demonstration in your office. It costs no more than other systems, yet offers so much more. Tape-Seal Storage Systems are being delivered daily to major computer installations throughout the U. S. and Canada. Write now for complete details.

©Patent Pending

Wright
LINE DATA PROCESSING ACCESSORIES

170 GOLD STAR BOULEVARD, WORCESTER, MASS. 01606

A division of Barry Wright Corporation 

IN CANADA: Wright Line of Canada, Ltd., 600 Eglinton Ave., East, Toronto 12, Ontario

CIRCLE 42 ON READER CARD



A New Twist

All Analex printers work the same way, but the new Analex low speed, low cost printer puts on a new twist. The low speed printer prints up to 300 lines in a minute and uses only half the number of hammers of conventional printers.

The Analex low speed printer is housed in a convenient console unit with a working surface only 30 inches high. It is ideally suited for the growing number of small scale data processing systems . . . communications applications . . . remote terminal systems . . . on-line to central computers . . . off-line as an independent unit.

Get in on the value of a full capacity reliable printer at less than half the cost. Write to Analex Corporation for full details on the new low speed printer.

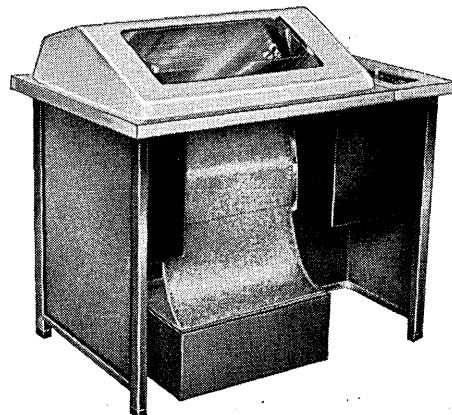

ANELEX



ANELEX CORPORATION • 150 CAUSEWAY STREET • DEPT. D-8 • BOSTON, MASSACHUSETTS 02114

CIRCLE 43 ON READER CARD

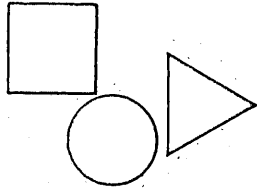

NEW PRODUCTS

reader-adder

The model 625' consists of three units: (1) a card reader accepts 80- and 51-column cards and automatically activates machine functions of (2) an

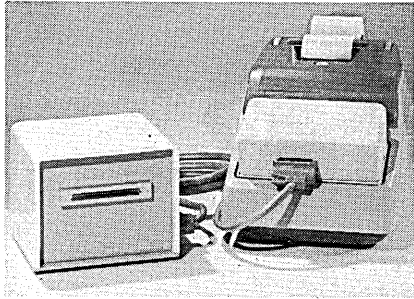

adding machine. Field selection is accomplished by (3) a program unit. Reading speed is 10 cps. DATA TRENDS INC., Parsippany, N.J. For information:

CIRCLE 130 ON READER CARD

lab computer

Integrated circuit version of the LINC (laboratory instrument computer) is program-compatible with the MIT models, has a cycle time of 8 usec. Basic system has 2K (12-bit) words of core, dual mag tape units, alphanumeric keyboard, and CRT. SPEAR INC., Waltham, Mass. For information:

CIRCLE 131 ON READER CARD

signal serializer

The Series 6010 converts outputs of digital voltmeters, a-d converters or volt-ohmmeters into serial data form. It can be programmed to select 11 input characters, plus three internally-generated characters, and convert them for typewriters, paper tape units, card punches, printout devices. ELECTRONIC ASSOCIATES INC., INSTRUMENT DIV., Long Branch, N.J. For information:

CIRCLE 132 ON READER CARD

disc memory

The F-6 features head-per-track design in a one-disc system with a capacity of 6 million bits. Average access time is 16.7 msec, transfer rate is 2.8 million bits/second, and unloading time for entire file is under 3 seconds. Weighing 49½ pounds, the unit measures 8¾ x 19 x 22 inches. There are 32 tracks/surface, total of

64, and head disc service life is said to be over 12,000 hours. Delivery is in 12 weeks. DATA DISC INC., Palo Alto, Calif. For information:

CIRCLE 133 ON READER CARD

storage scope

The 549 is a type 545B with fast-writing bistable storage capability. The 6 x 10-cm display area is divided into two 3 x 10-cm independently-controlled targets for split-screen applications, plus a non-storing "locate" zone at the left and a "run-over"

storage area at the right. Independent target control allows retaining one stored trace while obtaining conventional display, stored display or enhanced display on the other half. TEKTRONIX INC., Beaverton, Oregon. For information:

CIRCLE 134 ON READER CARD

seismic dp

The CFE-1 is a correlation and filtering unit for processing seismic data from field-recorded analog or digital tapes. Operating only with the 930 or 9300 computers, it performs up to

PRODUCT OF THE MONTH

The CM10009 is a management display system for use over Dataphone with the Univac 490, but is not restricted to that processor. It displays points, circles, strung characters in four sizes, and vectors in four line structure (dots, dot-dash, dash, or solid). All may be displayed in either of two brightnesses with or without blink, as controlled by the digital input. Digitally-controlled character rotation is also provided.

In addition to a 4K (30-bit) core buffer and a 21-inch CRT, there's a keyboard for the composing or editing of the display and

for composing command messages for the computer. A light pen is used to identify the address and word bit contents of the stored word associated with any displayed character or display element. And a memory-jump feature allows the computer to compose a display from among portions of the total message stored.

In parallel with the CRT, using auxiliary outputs provided in the system, a 12 x 12-foot display can also be operated. INFORMATION DISPLAYS INC., Mt. Vernon, N.Y. For information:

CIRCLE 135 ON READER CARD

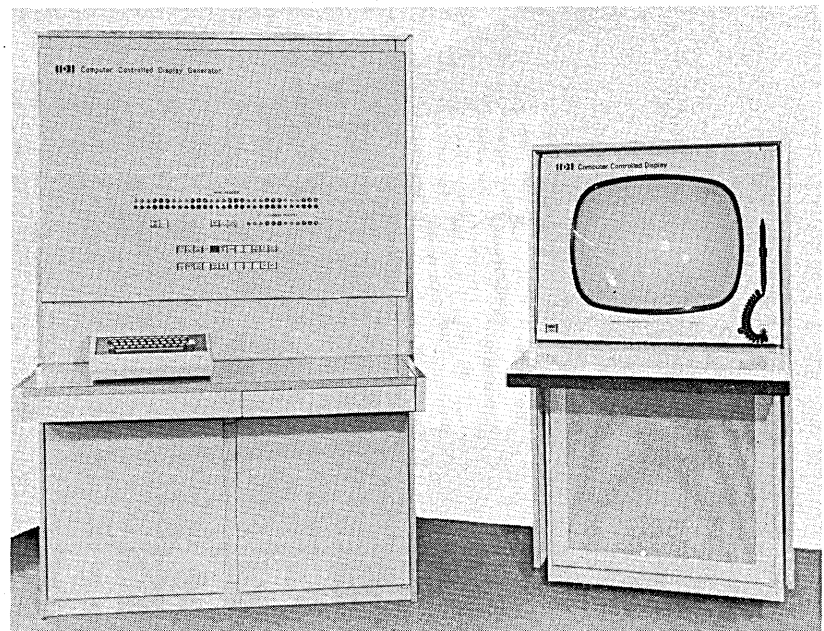



**BUILD
YOUR
FUTURE**

At the NCR Electronics Division, you build your career on hardware — not hope. Advanced developments like CRAM and the NCR 315 RMC Rod Memory Computer — the first commercially available computer with an all-thin-film main memory — are a marketplace reality. (And bear in mind that the NCR marketplace consists of more than 120 countries!) If you want to combine career stability with go-ahead, on-line opportunity... if you want to earn a good living while enjoying the good Southern California life... look into the opportunities on the page at the right.

NCR

ELECTRONICS DIVISION

**IN
WORLD-WIDE
BUSINESS
AUTOMATION
AT NCR,
LOS
ANGELES**

NEW PRODUCTS

6.8-million arithmetic operations per second. The system consists of a control section and up to 12 multiply/add sections. SCIENTIFIC DATA SYSTEMS, Santa Monica, Calif. For information:

CIRCLE 136 ON READER CARD

x-y plotter

The model 690 is an 8½ x 11-inch analog plotter that has a frequency response, with full-scale accuracies, to ± 0.5% and individual range calibration to 0.1%. Reference voltage is provided with mercury batteries.

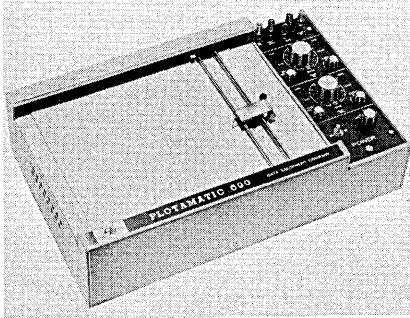

Twelve voltage ranges include 0.5 through 50 mv/inch and 0.1 through 5 v/inch, with continuous vernier on all ranges. Full-scale zero adjustment plus 100% offset is provided. DATA EQUIPMENT CO., Santa Ana, Calif.

For information:

CIRCLE 137 ON READER CARD

tape container

Shipments of mag tape on up to 10 10½-inch reels will be in styrofoam box which reportedly minimizes effects of temperature and humidity. Empty box serves as picnic cooler. U.S. MAGNETIC TAPE CO., Huntley, Ill. For information:

CIRCLE 138 ON READER CARD

crt console

The DIDS-400 is a table-model system with an alphanumeric keyboard and 6 x 9-inch display. It consists of the console, control unit, and optional hardcopy printer. Telephone line communication interface allows



remote use. Self-contained unit has character generator, refresh memory, and power supply, and screen holds 1,040 flicker-free characters. EQUIPMENT DIV., RAYTHEON CO., Lexington, Mass. For information:

CIRCLE 139 ON READER CARD

rack-mounted computer

The DATA 620 features bit-oriented logic, can be furnished with any word size from 16 to 24 bits, and has software compatible with all word lengths. Capacity is 4-32K words of core, memory cycle time is 1.8 usec, and add time is 3.6 usec. Among the 108 commands are multi-level indirect address, immediate and execute instructions. Two to 64 priority interrupts are available, as are FORTRAN compilers and an assembler. DATA MACHINES INC., Newport Beach, Calif. For information:

CIRCLE 140 ON READER CARD

a-d formatter

The ADF-4 takes analog signals or voltages on tape and generates IBM-compatible digital tapes. It is designed for use with incremental recorders operating at about 400 steps/second. Features: 1 to 4 channels of time-shared input data, 10-bit a-d converter, manual command-code input, internal or external clocking with counters to determine record length, record count, and to generate interrecord gaps. PASTORIZA ELECTRONICS INC., Newton Upper Falls, Mass. For information:

CIRCLE 141 ON READER CARD

distributors' software

Billing system for distribution organizations fits Series 200 computers of varying configurations. It handles multiple warehouse storage areas for an item, shipment records, storage of substitute item numbers in a master record. HONEYWELL EDP, Wellesley Hills, Mass. For information:

CIRCLE 142 ON READER CARD

calculator software

Punched-card programs for the Scientific model include mathematical functions for scientific/statistical applications and some business applications. WYLE LABORATORIES, El Segundo, Calif. For information:

CIRCLE 143 ON READER CARD

tape reader

The PTR 80N uses reflected light to read TTS and standard tapes, the changeover accomplished by a panel-mounted control. Speed is 500 cps synchronous, 200 cps asynchronously. OMNITRONICS INC., Philadelphia, Pa. For information:

CIRCLE 144 ON READER CARD



DIGITAL SYSTEMS OPPORTUNITIES AT NCR, LOS ANGELES

ADVANCED COMPUTER DEVELOPMENT

SYSTEMS DESIGN / Senior-level positions in advanced development and preliminary design of beyond-the-state-of-the-art data processing equipment. Considerable experience required in the over-all system design and integration of commercial computing equipment. BSEE required with advanced degree highly desirable.

MEMORY DEVELOPMENT / Positions will entail analysis and design of advanced thin-film memory systems, both linear select and coincident current. Also advanced random-access development on magnetic-card and disk-file systems. Requires BSEE, with advanced degree desired.

LOGIC AND CIRCUIT DESIGN / Openings are available for design of advanced integrated-circuit computers, buffering systems, on-line computing and transmission systems, and computer peripheral equipment. BSEE and good knowledge of state-of-the-art required.

MECHANISMS DESIGN / Senior-level positions available which entail working with new techniques for development of advanced high-speed random-access memories. Work requires five years' experience in servomechanisms and BSEE or BS in physics; or considerable experience in high-speed mechanisms and BSME and MSEE or BSEE and MSME.

PRODUCT ENGINEERING

ELECTRONIC PRODUCT ENGINEERS / These positions require a BSEE degree with experience in designing digital computer equipment and in maintaining liaison with manufacturing.

PACKAGING / These positions entail layout and design of packaging for computer systems. Applicants must have previous experience with electronic computers or electromechanical devices. Background in miniaturization utilizing thin films and integrated circuits is desirable. BSEE required.

PROGRAMMING DEVELOPMENT

SOFTWARE PROGRAMMERS / Positions entail development of software for various computer input/output routines, operating systems and monitors. Applicants must have previous programming experience with machine language on a large file computer.

DESIGN AUTOMATION PROGRAMMERS / Positions require previous experience in programming for design automation, good understanding of engineering and hardware problems, and BS degree in math, engineering or related field.

ARRANGE NOW FOR INTERVIEWS AT WESCON, SAN FRANCISCO, AUG. 24-27 Openings above are in Los Angeles. Additional openings in Dayton, Ohio, for mechanical, electrical and chemical engineers, physicists, chemists (MS or PhD level). Send resume to Bill Holloway, Technical Placement, or, if time doesn't permit, call collect.

The National Cash Register Company

NCR

ELECTRONICS DIVISION

2806 W. El Segundo Blvd., Hawthorne, Calif.
Telephone: Area Code 213-757-5111

An equal-opportunity employer

CIRCLE 92 ON READER CARD

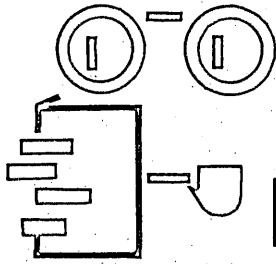

NEW LITERATURE

AUTOMATIC INDEXING: A STATE-OF-THE-ART REPORT: 220-page book discusses what indexing means, the weaknesses in various machine indexing

techniques and those inherent in human performance. The report also covers related research efforts in such areas as automatic classification and

categorization, computer use of the thesauri, statistical association techniques, and linguistic dp. Price: \$1.50. SUPERINTENDENT OF DOCUMENTS, U.S. GOVERNMENT PRINTING OFFICE, Washington, D.C. 20402.

NEW OFFICE OUT WEST

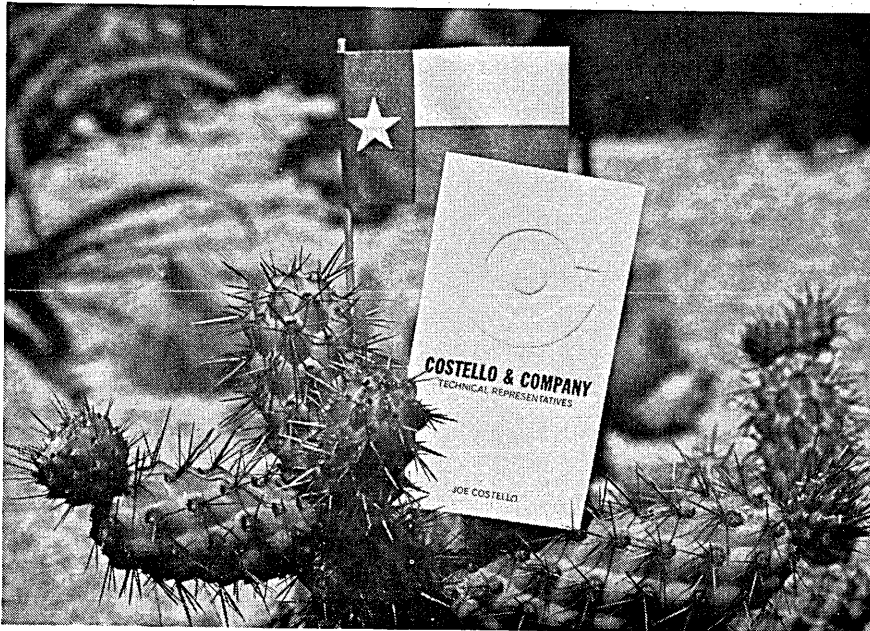

Costello & Company, the computer reps of the West, proudly announces the opening of their brand new office in Dallas, Texas to accommodate the growing needs of the computer industry in the Great Southwest.



COSTELLO & COMPANY the computer reps of the West

5635 Yale Boulevard
Dallas, Texas 75206
Phone: (214) 363-9031

Representing:
ACME/ACL/CORNING
ELECTRONICS/DIGITAL
DEVICES/FABRI-TEK/
RIXON/UPTIME.

IN TEXAS

Other offices out West:

5795 W. Washington Blvd., Culver City, California 90231/Phone: (213) 937-2980/TWX (213) 937-1229
535 Middlefield Rd., Palo Alto, California 94301/Phone: (415) 321-3745/TWX (415) 492-9205
15 North 40th Place, Phoenix, Arizona 85034/Phone: (602) 273-7348/TWX (602) 255-0387

CIRCLE 44 ON READER CARD

ELECTRONIC MANUFACTURERS: 340 members in the West are listed with detailed information for each company on management personnel, principal products, number of employees, how securities are traded and products marketed. There is also an alphabetical product cross-reference section which lists companies engaged in manufacture of specific components, instruments and systems. Price: \$5. WESTERN ELECTRONIC MANUFACTURERS ASSN., Los Angeles, Calif.

PERIPHERAL FORM EQUIPMENT: Four-page brochure illustrates how Formaliner adapts to typewriters, bookkeeping machines or computer console units for continuous forms writing. MOORE BUSINESS FORMS INC., Niagara Falls, N.Y. For copy:

CIRCLE 150 ON READER CARD

DISPLAY CONSOLE: Specifications are outlined in brochure for the 6320, which has 24-inch CRT; alphanumeric line-segment, and video display capabilities, and typewriter I/O. Built to customer specs. RCA AEROSPACE SYSTEMS DIV., Van Nuys, Calif. For copy:

CIRCLE 151 ON READER CARD

DIGITAL STRIP PRINTERS: Bulletin contains descriptions of operating principles, complete with simplified schematic and a graphic presentation of the timing cycle of Series 1200. Specifications give a detailed price breakdown. FRANKLIN ELECTRONICS INC., Bridgeport, Pa. For copy:

CIRCLE 152 ON READER CARD

ZIPCARD BUSINESS FORMS: Ten-page booklet printed to resemble a three-part interleaved ZIPCARD set, describes

no fanfare needed to announce our new east coast office

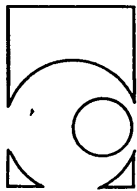

DIGITEK is quietly going about its business at two locations: writing the best compilers and software systems for the lowest prices anywhere.

DIGITEK CORPORATION

83 EAST AVENUE, NORWALK, CONNECTICUT 06850
(203) 838-4871

6151 WEST CENTURY BOULEVARD, LOS ANGELES,
CALIFORNIA 90045 (213) 870-7515

CIRCLE 45 ON READER CARD

CEC Announces the VR-3800

**A modestly priced six-speed
switchable tape transport...with
six-speed switchable electronics**

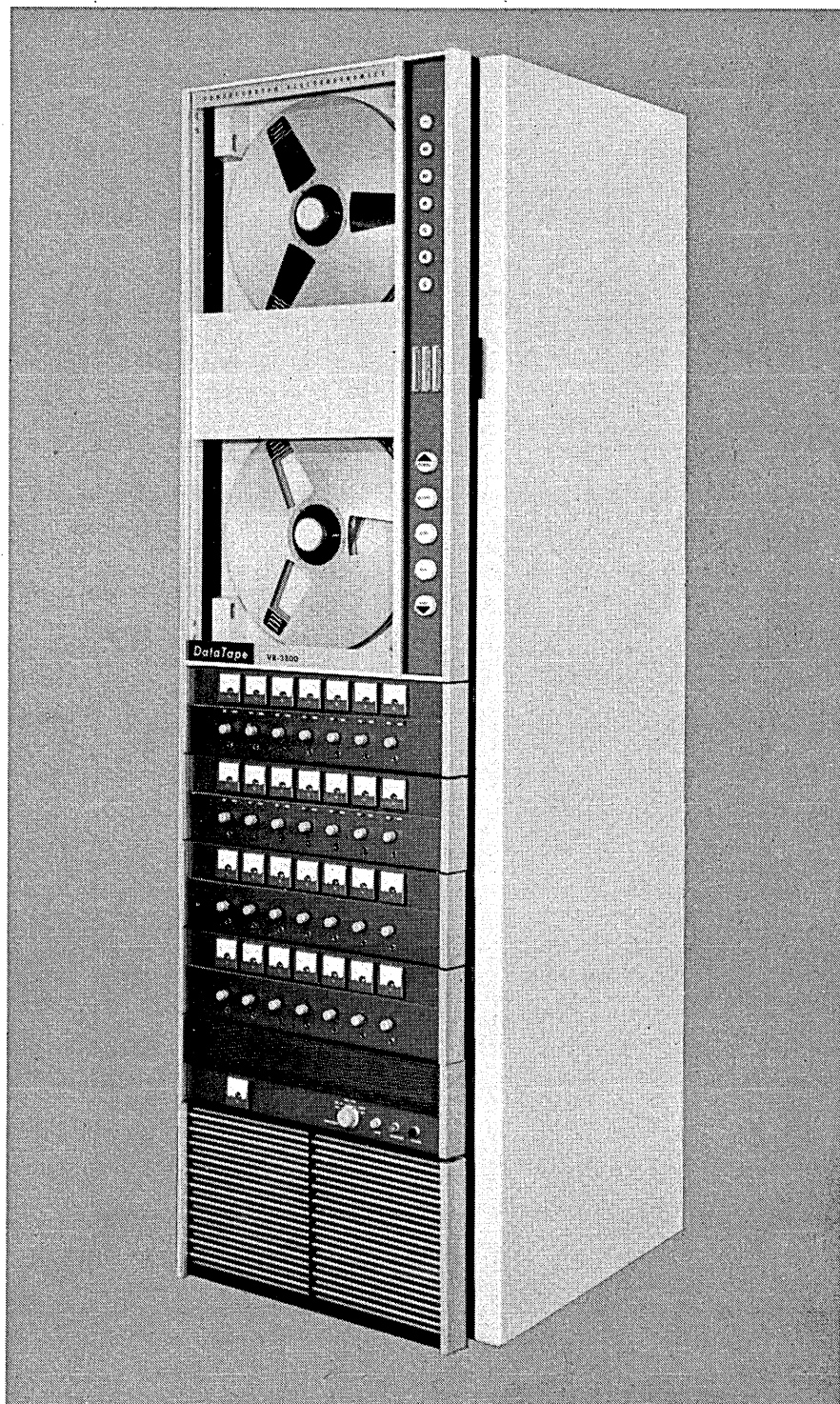

CEC's VR-3800 is the precise answer to a long-felt need. Namely, a magnetic tape recorder/reproducer that offers the basic advantages of CEC's top-rated systems at a *modest price*.

To users in most lab environments, this adds up to one important fact. The new VR-3800 is destined to become the work horse of midband recorders. For here is a recorder that is competitive in price with 100 kc class instruments, yet records up to 300 kc at 60 ips with unsurpassed reliability.

The VR-3800's outstanding features include:

- ▣ Six speeds to 60 ips; both transport and electronics electrically switchable. Speed sensitive plug-ins available for any number of transport speeds required. Buy only those you need, and save!

- ▣ Seven or fourteen channels may be used for data storage in the d-c to 300 kc frequency range.

- ▣ Extended wideband FM offers d-c to 40 kc at 60 ips. Standard FM from d-c to 20 kc at 60 ips.

- ▣ Longer lasting recording heads — smooth all-metal-front-surface design lasts up to 6 times longer than conventional heads, and reduces cleaning to a minimum.

- ▣ Record and reproduce amplifiers are solid-state, and the direct system is fully amplitude- and phase-equalized at all speeds, providing optimum square wave response.

- ▣ Signal-to-noise ratio is the highest; distortion the lowest.

- ▣ Tape tension constantly controlled by closed-loop servo control.

- ▣ Easy handling dynamic braking used exclusively. Fail-safe mechanical brakes used only when tape motion is stopped or power fails.

And—since all components are designed and manufactured by CEC, users realize the additional advantage of single-source responsibility.

For complete information about the VR-3800, call CEC or write for Bulletin 3800-X4.

CEC

Data Recorders Division

CONSOLIDATED ELECTRODYNAMICS

A SUBSIDIARY OF BELL & HOWELL/PASADENA, CALIF. 91109
INTERNATIONAL SUBSIDIARIES: WOKING, SURREY, ENGLAND
AND FRIEDBERG (HESSSEN), W. GERMANY

NEW LITERATURE . . .

the advantages of the tab card unit set, applications, sizes and styles and construction. Also noted are such features as guaranteed consecutive pre-printed control numbers that can be prepunched for use in IBM or Rem-Rand business machines. STAND-ARD REGISTER CO., Dayton, Ohio. For copy:

CIRCLE 153 ON READER CARD

TRAINING DEVICE: Booklet explains Digital Logic Lab and design tool engineered specifically for these uses and supported by instructional literature. It also covers breadboarding and testing, workbook and catalog, and specifications. DIGITAL EQUIP-MENT CORP., Maynard, Mass. For copy:

CIRCLE 154 ON READER CARD

OSCILLOSCOPES CATALOG: Listed are over 50 oscilloscopes plus both general-purpose and highly specialized oscilloscope plug-in units, including spectrum analyzers. TEKTRONIX, INC., Beaverton, Ore. For copy:

CIRCLE 155 ON READER CARD

NEW AND USED EQUIPMENT: Flexo-writers, Digitronics paper tape readers and Elliott card readers are listed in a price list for new and used equipment, which includes G-15's for less than \$10K, and IBM 1620 120K-core memory. LAMELLAR CORP., Pacific Palisades, Calif. For copy:

CIRCLE 156 ON READER CARD

TAPE TRANSPORT AND MEMORY SYSTEMS: Description, specifications and special features of the model TM-9 tape transport and TM-9200 tape memory system are included in brochure. AMPEX CORP., COMPUTER PROD-UCTS DIV., Culver City, Calif. For copy:

CIRCLE 157 ON READER CARD

PROGRAMMABLE CLOCKS: Available for IBM 360, 1400 and 7000, they can be installed on the 360 in the same manner as a model 2400 tape drive. Standard tape read commands are used to interrogate the clock calendar which then reads the time to the nearest sixtieth of a second and the date in months and days into computer memory. CHRONO-LOG CORP., Broomall, Pa. For copy:

CIRCLE 158 ON READER CARD

ELECTROBLOCK READERS: Two-page data sheet describes series 4000 for



This new electronic device offers radically improved technique for remote data collection...

See the new TPU. It is skillfully designed for remote data collection by unskilled office clerks who may have a few minutes to spare. What data? Transactions, branch office statistics, catalog order data, stock control, payroll or whatever data you need. Output? Punched paper tape, cards, adding machine tape. Flexible programming? Easy. Dependable accuracy? Complete message must be constructed on keyboard in such fashion that it satisfies supervision circuit before transmission can occur. Speedy? Only a teletype or night flight away from your immediate direct processing in your home office computer. And its cost? Cheaper than people. Now learn how the TPU modular, reliable, solid-state circuitry can improve your company's data collection . . . may we show you?

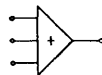

DIGITAL ELECTRONIC MACHINES, INC.
2130 JEFFERSON, KANSAS CITY, MO. 64108/AREA CODE 816-421-3181

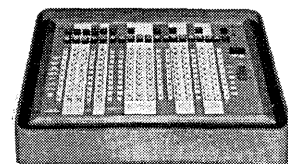

CIRCLE 47 ON READER CARD

Photocircuits' fully-militarized
500 RM TAPE READER
is the only reader to pass the tests for:
HEAT, COLD, VIBRATION,
EXPLOSION, SHOCK, ALTITUDE,
RFI, SALT, SAND AND DUST!

(as required by MIL-E-16400 Class 3 and MIL-T-21200 Class 2)

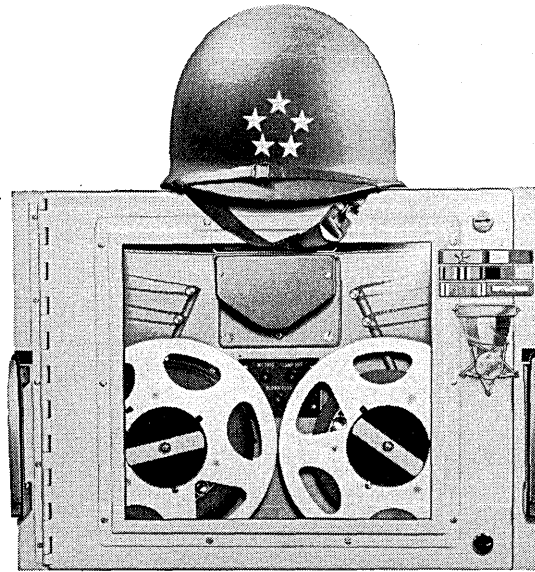

Still...the top military performer

Users of the 500 RM fully-militarized Tape Reader will not be surprised that it passed successfully a complete "campaign" of military environmental tests. Its speed, accuracy and reliability provide a performance that meets all the worst case conditions of the above MIL specs.

Specifically designed as a military unit, the 500 RM is a high-speed photoelectric reader providing speeds to 1,000 char/sec. — with 8" reels to give you maximum data-storage. Its smooth power comes from a unique printed-motor, direct-capstan drive. This means that all tape-reading modes are electronically controlled. The 500 RM has none of the clutch, pulley, brake or pinch-roller

problems inherent in conventional or hybrid tape readers, since all of this high-maintenance hardware has been eliminated.

If your department or agency requirements demand top performance with MIL spec reliability — find out about the 500 RM Tape Reader today. Simply write or phone: Photocircuits Corporation, Tape Reader Division, Glen Cove, New York. Telephone: (516) ORiole 6-8000.



Photocircuits
CORPORATION
TAPE READER DIVISION
GLEN COVE, NEW YORK

COMPUTER SCIENCES CORPORATION

Opportunities For
Scientific and
Systems Programmers
in Los Angeles,
Houston, and
Richland, Washington

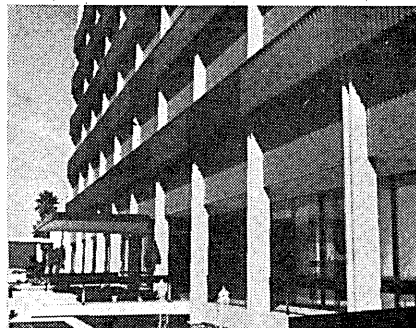

CSC offers advanced project participation in Air Weapons Control Systems, Naval Strategic and Tactical Data Systems, Real-Time Systems, Time-Sharing Systems, Executive Systems and Compilers and Assemblers.

A stimulating professional environment, opportunity to participate in advancing the state of the art, liberal compensation and generous employee benefit plans are key features of this leading firm of computer specialists.

If you are outstanding in the application of large-scale computers to scientific and systems problems, send resume to
Mr. G. E. Eckermann



COMPUTER SCIENCES CORPORATION

650 No. Sepulveda Boulevard
El Segundo, California 90245
Area Code 213 678-0592

An Equal Opportunity Employer

CIRCLE 93 ON READER CARD
August 1965

NEW LITERATURE . . .

simultaneous reading of five to 20 (8-bit) paper tape characters and includes technical specifications. ELECTRONIC ENGINEERING CO. OF CALIF., Santa Ana, Calif. For copy:
CIRCLE 159 ON READER CARD

FLOOR MAINTENANCE: Three-page folder gives instructions for the care of all types of resilient floor materials used in pedestal and computer floor areas. Folder can be tacked on wall for easy reference by maintenance personnel. ARMSTRONG CORK CO., Lancaster, Pa. For copy:
CIRCLE 160 ON READER CARD

PORTABLE CARD PUNCH: Hand-actuated card punch, model 311, which accommodates standard 51 or 80 column tab cards is described in brochure. Features covered include simultaneous 12-column operation, read-out window verification, interpret printout, operating details for production line and applications. DASHEW BUSINESS MACHINES, Los Angeles, Calif. For copy:
CIRCLE 161 ON READER CARD

FORMS BURSTER: Illustrated leaflet supplies specifications for burster that can detach multiple part forms at 75-120 feet/minute, handle forms 2 $\frac{3}{16}$ to 12 inches long and up to 16 inches wide. TAB PRODUCTS CO., San Francisco, Calif. For copy:
CIRCLE 162 ON READER CARD

PRINTER/PLOTTER: Brochure enumerates features, approach, modularity and characteristics of Digiprint output system that operates at printing rates of up to 85,000 cps, or plotting rates of 5,000 lines/second. BURROUGHS CORP., ANN ARBOR LAB, Ann Arbor, Mich. For copy:
CIRCLE 163 ON READER CARD

TAPE TESTER: Brochure lists features of model 97 which can test nine as well as seven track and full width tape and is useful in certifying or rehabilitating tape. GENERAL KINETICS INC., Arlington, Va. For copy:
CIRCLE 164 ON READER CARD

DATA TRANSMISSION: 10-page brochure describes 26C data set which weighs 20 pounds, is 3 $\frac{3}{8}$ inches high and transmits 2400 and 1200 bps over a 3kc voice channel derived on cable, open wire or microwave radio. LENKURT ELECTRIC CO., INC., San Carlos, Calif. For copy:
CIRCLE 165 ON READER CARD

SEND FOR FREE WRIGHT LINE 3-D FLOOR PLANNING GUIDE for new data processing departments

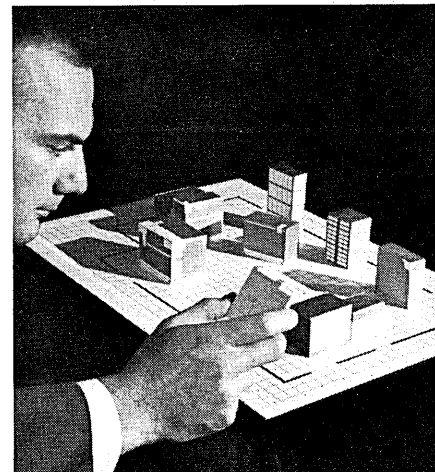

You get:

- Three-dimensional scale models of your data processing equipment
- Similar models of Wright Line handling and storage equipment
- A layout sheet large enough for a 36' x 48' area
- Instructions for assembly and arrangement of elements

Now you can easily determine maximum efficiency and work flow in your new data processing department! Send for your free floor-planning guide by writing to us on your company letterhead. Tell us your type of system (IBM or UNIVAC). Your free guide will be mailed to you immediately. A Wright Line specialist will be happy to help you assemble the various pieces in the guide and work closely with you in planning your installation. Our address: Wright Line, 170 Gold Star Boulevard, Worcester, Massachusetts. In Canada: Wright Line of Canada, Ltd. 600 Eglinton Ave., East, Toronto 12, Ont.

Wright LINE

DATA PROCESSING ACCESSORIES
A division of Barry Wright Corporation 

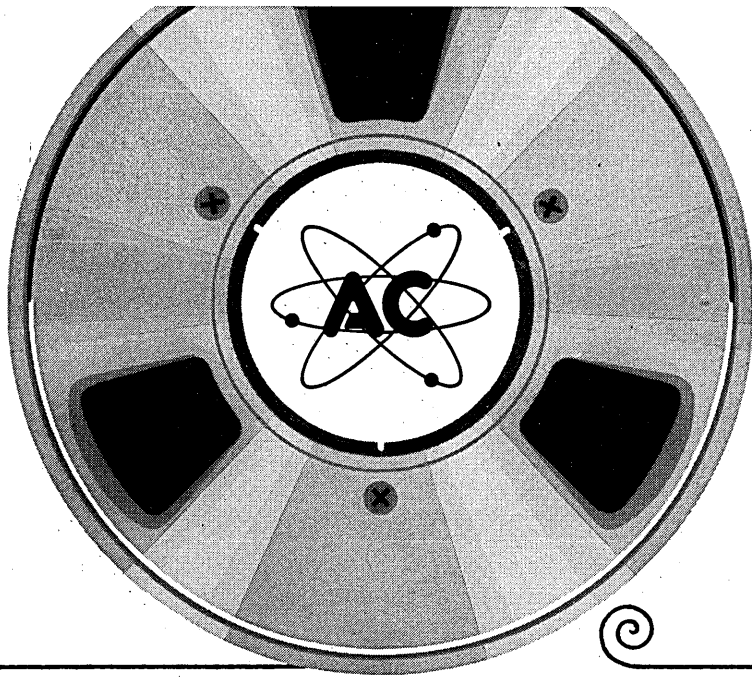

SCIENTIFIC PROGRAMMERS
Reprogram your career
in the aerospace field with the
newest Division
of General Motors

Titan III, Apollo, LEM. These are typical of the space-age projects you may be working on as a member of the new AC ELECTRONICS DIVISION OF GENERAL MOTORS. We're looking for qualified Programmers to fill immediate vacancies at all three AC Electronics Division locations . . . our main facility in Milwaukee, and our Advanced Concepts Laboratories in Los Angeles and Boston. If you meet the requirements for any of the positions listed below, send us your resumé today!

In Milwaukee:

SCIENTIFIC PROGRAMMERS . . . to analyze and prepare computer programs for solution of engineering and scientific problems utilizing the IBM 7090. Applications include flight and ground test data reduction and missile trajectory simulations. Degree in Math, Physics or Engineering. Minimum of two years experience plus operating knowledge of large scale digital computers.

In Los Angeles:

SR. SCIENTIFIC PROGRAMMERS . . . Responsibilities include the development of large scale digital computer programs for orbit determination and simulation of highly complex space and missile guidance systems. BS or BA Math or Physics plus experience on IBM 7000 series required.

In Boston:

PROGRAMMER (Scientific/Real Time) . . . Analyze and develop digital computer programs for solution of engineering problems related to inertial navigation systems and components. BS in Math, Physics or EE required with experience in machine language and Fortran.

Send resumé to:

Mr. R. O. Schroeder, Director of Scientific and Professional Employment, Dept. 5173, AC Electronics Division of General Motors, Milwaukee, Wisconsin 53201. Your resumé for one of the above positions will be reviewed in confidence and a reply made to you within a matter of days.

AC ELECTRONICS DIVISION OF GENERAL MOTORS
Milwaukee, Wisconsin

An Equal Opportunity Employer

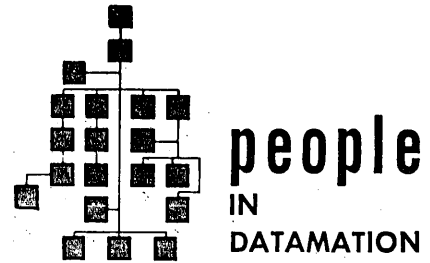

■ The OPCON Users Society elected new officers: W. K. Kays Jr., president, and Dennett Withington, vice president.

■ President-elect of ADAPSO (Assn. of Data Processing Service Organizations Inc.) is S. J. Tesauro, president of S. J. Tesauro & Co., a Detroit service bureau.

■ George Armerding has been appointed manager, development programming, Scientific Data Systems, Santa Monica, Calif. He was formerly with The RAND Corp.

■ IBM has elected Dr. Eugene G. Fubini as a vp, Armonk, N.Y. He was formerly assistant Secretary of Defense and deputy Director of Defense Research and Engineering.

■ Elected to vp, Memorex Corp., Santa Clara, Calif., were Rex D. Lindsay and Eugene L. Rogers.

■ The newly-created position of assistant gm, Computer Sciences Corp.'s Northwest Div., has been filled by Arthur E. Speckhard, formerly with Bellcomm.

■ Michael J. Samek has been appointed director of the international division, Auerbach Corp., Philadelphia, Pa. He will be operating out of the Koninginnegracht, Hague, Netherlands office.

■ Robert W. Blucke has been named director of international operations for Honeywell's edp division. He succeeds J. M. Sterling, who has been promoted to managing director of Honeywell's European computer organization, London, England.

■ Herbert Van Brink has joined the senior technical staff, Computer Applications Inc., New York City. He is also manager of the FORTRAN project of SHARE.

■ Dr. Robert W. Harrington has been appointed assistant manager, advanced systems division, System Development Corp., Santa Monica, Calif.

■ Marvin Minsky has taken a year's leave of absence from MIT and Project MAC to join Information International Inc., Cambridge, Mass.

■ Robert A. Hoodes has joined General Analytics Corp., a consulting and computer systems design firm, New York City. He was formerly with IBM, Federal Systems Div.

adp DATAMATION GLOSSARY

DATAMATION is offering a 62 page glossary of data processing terms. The booklet is compiled in easy to read alphabetical listings with cross references. This glossary can be of great value in your daily work in the data processing field where terminology is so very important.

\$1.00
each

75c

in lots of ten
to 49 copies

50c

in lots of 50
or more copies

DATAMATION

141 East 44th Street, New York 17, N.Y.

Enclosed is \$ _____ covering my order for
_____ copies _____ of the adp glossary

NAME _____

COMPANY
ADDRESS _____

CITY _____ ZIP _____

STATE _____

Add 4% sales tax on N.Y. City orders

RESERVED ?

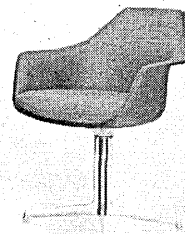
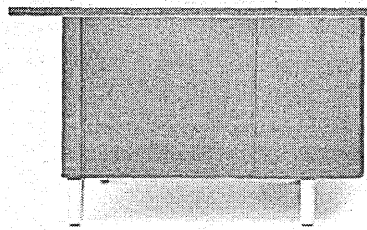

The desk is... but not the atmosphere. The desk is reserved for the man who wishes to participate in long-term research and development programs or to develop data systems for all applications. The atmosphere is unreserved. Our Burlingame, California, and Sierra Vista, Arizona, research centers offer the facilities, the stability (14 years of successful performance), and the working environment necessary for productive research.

Are you currently engaged in research, development or implementation in any of the following areas?

Fluid dynamics • Soil and structural mechanics • Nuclear and thermal radiation • Explosion technology • Vulnerability analysis • Mathematical and statistical modeling • Computer simulation • Logistics • Management information systems • Computer programming aids, languages and applications.

If your experience and interests parallel ours, please send us a resume.

URS*

CORPORATION

1811 Trousdale Drive, Burlingame, California

*Still known to some of our older friends as Broadview (BRC), United Research Services (URS), and various other aliases reflecting a spirit of experimentation.

AN EQUAL OPPORTUNITY EMPLOYER - BY CHOICE

CIRCLE 96 ON READER CARD

WANTED

An Applied Mathematician

... to formulate and apply advanced mathematical equations and formulae to a wide range of engineering, operational and statistical problems encountered in the operation of a large water utility. He will conduct studies of water and sewage plant operations, make hydraulic and hydrological studies pertaining to Philadelphia's watershed and provide professional assistance in the development of engineering and scientific computer applications.

He must have a master's degree in mathematics including physics, applied science or engineering course work and 1 year experience in computer programming or operations. A PhD in mathematics will meet all requirements. Salary \$8,864-\$10,104.



CITY of
PHILADELPHIA

Send resumes or phone collect

FLOYD H. PLATTON, Personnel Officer
WATER DEPARTMENT
1130 Municipal Services Bldg.
Philadelphia, Pa. 19107
(215) 686-9700, Ext. 3826

CIRCLE 97 ON READER CARD

HERE'S AN OPPORTUNITY

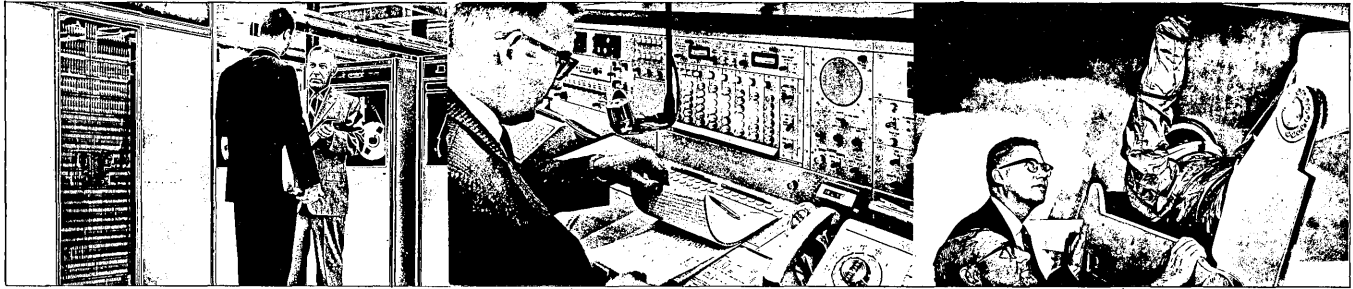

TO IMPROVE YOUR FUTURE

... Both professionally and personally. Every project at Collins is the most demanding in its area of industry, and we need professionals to continue the growth this level of qual-

ity has created. Living and working conditions—and compensation—are commensurate with these standards. These listings are current.

SEND RESUME FOR PROMPT INFORMATION

DIGITAL SYSTEMS ANALYSTS — Require six to ten years experience in digital hardware and software system design, specifically in areas of communication, computation and control. Job responsibility involves determination of optimum hardware/software configuration and specifies required application programming. M.S.E.E. required, Ph.D. desirable. (Cedar Rapids and Newport Beach)

DIAGNOSTIC PROGRAMMERS — Minimum of two years experience required in writing factory and/or field diagnostic programs for digital computer hardware. Heavy knowledge of digital equipment organization is necessary. B.S.E.E. required. M.S.E.E. desirable. (Cedar Rapids)

DIGITAL HARDWARE SYSTEMS DESIGN — Requires minimum of four years experience

in circuit/logic/system design. Some programming experience is desirable. Work will involve design and development of digital hardware subsystems (LPU's, NPU's, communication links, etc.). B.S.E.E. required. M.S.E.E. desirable. (Cedar Rapids and Newport Beach)

MEMORY DESIGN ENGINEERS — Requires two to eight years experience in core memory design and/or solid state circuit design. Job duties involve design, specification, development, and test of memory arrays and electronics for high speed core memories. B.S.E.E. required, M.S.E.E. desirable. (Cedar Rapids and Newport Beach)

PROGRAMMERS — Openings for software programmers to participate in developing advanced software systems including compiler, assemblers, interpreters,

simulators. Stored logic programming for real-time systems. A degree and a minimum of three years applicable experience are required. (Dallas and Newport Beach)

MATHEMATICIAN/ANALYSTS — M.S. or Ph.D. with two or three years in Mathematical Analysis and simulation of real-time systems. Must be proficient in statistical analysis, queueing analysis, and should understand latent programming techniques for analysis. (Newport Beach)

COMPUTER SYSTEMS ENGINEERS — B.S., M.S. or Physics degree. Must be experienced in systems analysis or multiple computer multi-program systems with special emphasis on the application of small high-speed serial computers to communications and process control. (Newport Beach)

COMMUNICATION / COMPUTATION / CONTROL



COLLINS RADIO COMPANY
An equal opportunity employer

DPMA INTERNATIONAL CONFERENCE

bigger and
better

A record 2,700 data processing personnel gathered at the DPMA International Conference and Business Exposition in Philadelphia to hear evaluations and predictions concerning management information systems, dp management and education, hardware, and software.

The 40 sessions may not have been distinguished by any startling new announcements, but the quality of the speakers and their talks was generally thought to be the best ever presented at a DPMA conference.

Apropos to the locale and time—just before Independence Day—the keynote address of Walter Finke, president of Honeywell EDP, was an eloquent Declaration of Independence (Liberation) for data processing management. He called upon managers to take their places as leaders in business hierarchies and to base their decisions and practices on “knowledge, perspective, objectivity, and honesty.” For example, he warned against succumbing to “mass think” pressures to implement “in” developments, like time-sharing, unless they are clearly suited to the needs and capabilities of the company. At the same time, dp heads should not let “personal bias and past tradition” cloud the facts that call for change. His final point: managers, once making a sound decision, should courageously resist unreasonable pressures which would deter them.

Management information systems were the major topic of the meeting. William Lonergan of RCA summarized some of the present constraints on MIS development—most of which were discussed in more detail in sessions across the program. The human factor is a major limitation, he said, as there is a lack of systems people with enough experience and broad knowledge to structure them; political conflicts are also problems. In hardware, the high costs of terminals, communications lines, and main memories are prohibitive unless there is enough activity to justify them; the needed graphic storage and transmission are underdeveloped areas. Finally—lack of standardization and the multiplicity of programming languages used.

Many of the seminars were tutorial, and the audiences were apprecia-

tive of the definition and instruction given at such seminars as Design and Implementation of Management Information Systems, Software Consideration for MIS, Simulation and Mathematical Modeling, Centralization vs Decentralization, Optical Scanning, and Operating Systems. Practicality was the demand, and most participants, who could only attend four full sessions, were intolerant of the overly technical, equation-filled talks, “political” speeches, or sales pitches that they could not relate to their dp problems.

Seminars on programming languages were well presented, though not exciting, and many would have preferred a panel debating the merits of PL/I vs. other high-level languages. Decision Tables was said to be an excellent session, but, said one attendee, “I wouldn’t want to use them.”

Many future developments were noted. One in the planning stage that will affect both installation and communications costs is AT&T’s electronic switching system; if the government overrides Western Union objections and permits data transmission through it, the system will eventually eliminate the need for user switching units and free the manufacturer from producing them.

The programming in the ’70’s panel did an excellent job of pinpointing hardware and software trends. About the much-discussed idea of a universal language, Dr. Richard Clippingier of Honeywell said, “The need for a programming language to converge rapidly to stable form is in fundamental conflict with the dynamic changes important to the development of computers, and can be expected to continue unabated in the next decade. It is not likely that any language will achieve universality, but rather that there will be a slow succession of improving languages, each processing a broader area of application than its successors.” The inevitable move toward time- or system-sharing, felt Robert Hench of GE, would mean the downfall of machine language and of higher level languages with syntactical constraints, like FORTRAN and MAD.

Dr. John Carr of the Moore School predicted the programmers of the ’70’s will be the machine and the sophisti-

“Get Acquainted” Offer

If you’ll tell us more about yourself through the confidential resume below, we’ll know where to send you this booklet telling more about ourselves.

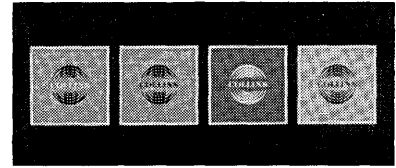

Send resume to Manager,
Professional Employment,
Collins Radio Company

Cedar Rapids, Iowa
Dallas, Texas
Newport Beach, California



Name _____ Home Address _____

City & State _____ Phone _____

Present Position, Company _____

Primary Experience Area _____ No. of years _____

Education: EE _____ ME _____ Math _____ Physics _____ Chemistry _____

Bus. Adm. _____ Other _____ MS _____ PhD _____

Degree: BS _____ school, date _____ MS _____ school, date _____ PhD _____ school, date _____

Please attach any pertinent information .

2

computer careers

Should you base your career on just one interview? Make your choice from among several career positions!

EUROPEAN and NATIONWIDE CHOICE

N.Y., N.J., NEW ENGLAND, WASHINGTON, D.C., PHILA., MINNESOTA, TEXAS, HUNTSVILLE, FLORIDA, ARIZONA, CALIFORNIA AND OTHERS

Contact us if you have some experience or interest in any of the following:

- Scientific Computation** — Data Reduction or Numerical Analysis—Unusual Outerspace/Lunar and Advanced Programs
- Software Development** — Languages, Compilers, Assemblers, Monitors or Sub-Routines
- Real Time Systems** — Message, On Line, Process Control
- Systems** — Planning, Design, Analysis of State of the Art Massive Data Handling of I.R. Systems
- Technical Representatives** — Programming and Systems support to Sales
- Digital or Logical Design**
- Management Sciences**
- Sales and Marketing**

Unique opportunities exist in the \$9000-25,000 class for Managers & Seniors and Men who can accept management responsibility and professional growth

newest **COBOL & FORTRAN** newest
Software Implementation & Techniques, Programming/Analysis—\$9-21,000

All expenses are assumed by our client companies.

Write in confidence, including present salary, acceptable locations or call (Collect) Mr. Nellissen (Area Code 212) PLaza 9-1720

a&n
ALBERT, NELLISSEN, INC.

Leading Consultants to Management in the Data Processing Field

510 MADISON AVENUE, N.Y., N.Y. 10022

DPMA...

cated user, who will be versed in a "calculus of programs," a "set of rules which can be manipulated automatically to produce certain proposed results." As the panel summarized all the changes coming, they wondered how many in the present generation of computerites will be able to move up to the new breed of systems.

If the 102 exhibits at Convention Hall were not the most exciting, they were colorful—with magicians, a putting green, scarcely attired girls, prizes, and a first-aid station which wisely offered coffee, Tums, and tomato juice. (The putting green of Graphic Control Inc.—which drew huge crowds—was a replacement for the forms which never arrived because of a trucking strike. Anybody find a box of DATAMATION magazines, by the way?)

Among the major manufacturers, Burroughs perhaps stole the show with its twin-processor B300 system, which simultaneously handled on-line banking, accounting, and inventory functions. IBM also drew many to its showing of a 360/30, with emulator, which ran several 1401, 40, and 60 programs in commercial use at about twice the speed. Univac roused interest with its new 1001 card controller, and on the other side of the floor, offshoot Mohawk Data Sciences gloated over its 1101 data recorder, of which it has installed 175 since the March announcement. Having its first showing was the DPA Inc. 4020 punched card processing system, which combines the IBM 402 accounting machine with a Wyle Labs programmable arithmetic processor and is capable of handling pre-programmed subroutines of up to 96 program levels. A keyboard-display is optional.

Most heavily represented, of course, were accessories manufacturers, with forms, reportedly a \$600 million/year business, dominating all. Point of interest: the recent IFIP show and DPMA had about 17 exhibitors in common.

At the banquet it was announced that the new international president of DPMA is Daniel Will, senior analyst of the data processing department of Canadian National Railways and formerly international executive vice president of DPMA.

The last word at the conference was had by a slab of ice cream at lunch. "Y'all come to Dallas," it read. That's the scene of the Fall International Conference, November 3-5. Should be the biggest, shouldn't it?

—ANGELINE PANTAGES

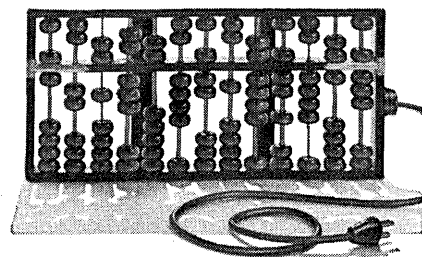

"LOOK AT LOCKHEED IN COMPUTERS AND PROGRAMMING..."

ANALOG
BUSINESS
SCIENTIFIC
DIGITAL

Lockheed Missiles and Space Company operates the largest single industrial digital computer facility in the United States. It provides exceptionally versatile and advanced computation and data reduction services to all parts of the Company.

Degree and appropriate experience are required for the following assignments:

DESIGN computer systems and evaluate equipment for information retrieval, graphic processing and real-time missile component testing.

DEVELOP advanced software operating and programming systems on IBM 1410/7094 computers and Univac 1107/1108 computers.

OPTIMIZE commercial programs for efficiency and cost reduction and adapt programs to new equipment, certifying for conformance.

DEVELOP real-time data systems for commercial applications such as source data acquisition, updating, retrieval and administrative control systems.

ANALYZE and program new business applications on medium and large scale computers. Develop financial, engineering, manufacturing and procurement integrated systems for real-time and off-line functions.

PROGRAM and operate analog or hybrid computers and differential analyzers. Define models for simulation of aerospace guidance and control problems and analyze results.

Please write Mr. K. R. Kiddoo, Professional Placement Manager, Lockheed Missiles & Space Company, 443 Industrial Relations Building, P. O. Box 504, Sunnyvale, California

LOCKHEED
MISSILES & SPACE COMPANY
A GROUP DIVISION OF LOCKHEED AIRCRAFT CORPORATION
An equal opportunity employer



WHO READS DATAMATION?

A world-wide assortment of
high-level decision-making
technical professionals
of the data processing
field. If you sell a
product or a service
that is centered around
this group — tell it
where it will be read.

Tell it in
DATAMATION

**THE MAGAZINE OF AUTOMATIC
INFORMATION PROCESSING
FOR BUSINESS & SCIENCE**

DATAMATION

An F. D. Thompson Publication
**THE ONE PUBLICATION THAT SERVES
THE WHOLE DATA PROCESSING FIELD**

NEW YORK, 10017 141 East 44th St.	LOS ANGELES, 90006 1830 W. Olympic Blvd.
CHICAGO, 60606 205 W. Wacker Dr.	MANCHESTER, N. H. 112 West Haven Rd.
CLEVELAND, 44113 75 Public Square	LONDON 27 Baker St., London W.1.

Who's on seventh?

We see in the press that SDS is supposed to be number seven in computers. That's fine with us, but, frankly, we're more interested in being first than being seventh.

First? You bet: First to deliver a commercial computer utilizing integrated circuits, first to standardize on silicon semiconductors, first to crack the 2 microsecond barrier with a moderately priced computer, first to make magnetic tape capability economically feasible for the small computer user, first to get as big as we are as fast as we have. And so forth. Who cares about being seventh or sixth or fifth so long as they're getting the lion's share of firsts? Not us.

How are you doing? Getting your share of firsts? If you are, fine. If you aren't, come talk to us. We have openings across the board in hardware, software, systems, sales and service for anyone who likes running out in front of the pack.

Look at it this way. We need you if we're going to stay the fastest growing of the major computer companies.

And you need us if you want a crack at some honest firsts because if you can't get them at SDS, you'll never get them *anywhere*.

Sound reasonable? Then get in touch with Bill Kendall at: SCIENTIFIC DATA SYSTEMS, 1649 Seventeenth St., Santa Monica, California.

SDS

stagnation

IS IT THREATENING YOUR CAREER?

To an engineer or programmer, temporary stagnation of his career can mean obsolescence — prior efforts and hard work go up in smoke unless he keeps abreast of innovations and advances in a rapidly changing technology.

If your current environment no longer taxes your abilities or affords an opportunity for increased responsibility, we suggest you investigate the following opportunities by forwarding a resume at your earliest convenience.

SYSTEMS ENGINEERS

Will develop and analyze complete digital computer systems requirements from source information to final display, control, printed and/or other outputs. Will also coordinate mechanical design efforts for new systems. Requires a minimum of two years' experience in stored program digital computer oriented systems design, preferably with application to commercial systems. Salary, \$9,000 to \$18,000.

LOGICAL DESIGN ENGINEERS

Intermediate and senior level positions are available in a diversity of disciplines, including the creation of functional specifications of peripheral equipment control and central processors, feasibility analysis for proposed systems, determination of logical sequence with machine operation and determination of circuit and other hardware requirements. Requires a minimum of two years' related experience in digital systems planning, logic design or systems design. Salary, \$9,000 to \$19,000.

MICROELECTRONIC CIRCUIT DESIGN ENGINEERS

Will evaluate programs to determine the application of microminiaturization to scientific, commercial and military computer systems. Techniques include hybrid and monolithic microminiaturization. Requires minimum one year's experience in microminiaturization techniques. Salary, \$8,500 to \$15,000.

PROGRAMMERS/SYSTEMS ANALYSTS

Will design and develop specifications for electronic data processing systems, including test and diagnostic systems, advance design simulation and test programs. Requires at least one year's experience in the programming of large or medium scale digital computers. Salary, \$7,500 to \$12,000.

All replies will be held strictly confidential and answered immediately. Fees and relocation expenses are assumed by our client companies.

ACM INTERVIEWS

Visit us during ACM Meeting
August 24-26th, Cleveland, Ohio

MICROELECTRONIC PACKAGING ENGINEERS

Intermediate, senior and Section Head positions are available in the investigation, design and evaluation of micro-electronic packaging systems. Design areas include interconnection of hybrid and monolithic circuits, advanced economical production process development. Requires a minimum of one year's experience in micro-electronic packaging including experience with materials in multi-layer board applications. Salary, \$10,000 to \$15,000.

DESIGN AUTOMATION PROGRAMMERS

Positions available involving the design, development and programming of engineering data processing systems for the automation of electronic computer design. Specific areas include logic design and simulation, wiring design, documentation and manufacturing automation. Requires experience in design automation, computer design, programming, work flow analysis and application of data processing techniques to production documentation of engineering development. Salary, \$9,000 to \$13,500.

PROGRAMMERS/CONVERSION TECHNIQUES

Will be concerned with the development and implementation of methods for conversion of programs from one computer to others. Will work with engineers towards the solution of hardware/software approaches to conversion problems by means of simulation, translation, or a combination of techniques. Salary, \$8,000 to \$13,000.

TECHNICAL WRITERS

Will be responsible for the gathering, writing and editing of material detailing programming routines for publication such as assembly and utility routines, compilers and sorts for incorporation into users' manuals. Minimum of two years' related technical experience, plus an understanding of programming documentation. Salary, \$8,000 to \$12,000.

DATAMAN* **A S S O C I A T E S** **PERSONNEL CONSULTANTS**

120 Boylston Street

Boston, Massachusetts

617-423-5858

*DATA MANAGEMENT . . . Recruiting Specialists for Electronic Data Processing Personnel Exclusively

CIRCLE 101 ON READER CARD

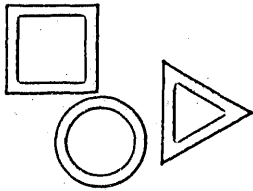

THE DATAMART

Address all replies to box number advertisements as follows:

Box.....
DATAMATION

F. D. Thompson Publications, Inc.
141 East 44th St.
New York, N. Y. 10017
Classified Advertising

PROFESSIONAL SERVICES

MANDATE

Management Data Engineering for Business and Industry

Computer Systems - Consulting - Design - Development - Applications
Batch Processing - Real Time - Time Sharing
Programming - Language Development - Implementation - Documentation

J. B. WIENER
Director

R. KORFF
Applications Manager

Management Data Engineering

3033 N. Central Avenue

Phoenix, Arizona 85012

Phone 60-277-6178



JUSTIN A. PERLMAN
PRESIDENT

THE LAMELLAR CORPORATION OF AMERICA

1011 SWARTHMORE AVENUE
PACIFIC PALISADES, CALIFORNIA 90272
TELEPHONE (213) 454-7244

SERVICE TO THE TRADE

Charles W.

adams associates

inc.

Computer Programming and Consulting Services
Specializing in On-line Real-time Systems

575 TECHNOLOGY SQUARE · CAMBRIDGE · MASSACHUSETTS 02139

HALSTEADS T.V. Service. Over 30 yrs! exp. Elec. Appliances repaired. 137 Mansion St., Poughkeepsie, New York 12601.

ROBERT L. PATRICK
COMPUTER SPECIALIST

9935 DONNA 213-349-2225
NORTHBRIDGE, CALIFORNIA

BUSINESS OPPORTUNITIES

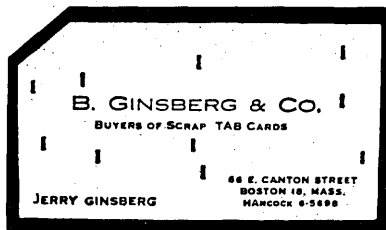

USED EQUIPMENT

COMPUTER

For sale at sacrifice price for immed. disposal. U.S. Govt. surplus UNIVAC 1101, with \$1,000,000.00 original cost. For full particulars write DAT, P. O. Box 43, Detroit, Mich 48221

FOR SALE or LONG TERM RENTAL

Speeded up 402, 604 and 514

(under continuous IBM maintenance)

and other related miscellaneous equipment

B. B. BLITZ, 212 PL 9-6363

WANTED: IBM KEY PUNCHES. Also TABULATORS, COLLATORS . . . INTERPRETERS . . . CALCULATORS . . . SORTERS . . . REPRODUCERS, etc. Highest Prices Paid. Call Collect (212) 673-9300 INTERNATIONAL OFFICE APPLIANCES, INC. 383 Lafayette St., New York, N. Y. 10003

EXCLUSIVE FRANCHISE

Amazing new liquid plastic coating used on all types of surfaces interior or exterior. Eliminates waxing when applied on Asphalt Tile, Vinyl, Linoleum, Vinyl Asbestos, Hard Wood, and Furniture. Completely eliminates painting when applied to Wood, Metal, or Concrete surfaces. This finish is also recommended for boats and automobiles.

NO COMPETITION

As these are exclusive formulas in demand by all businesses, industry and homes. No franchise fee. Minimum investment—\$300. Maximum investment—\$7,000. Investment is secured by inventory. Factory trained personnel will help set up your business. For complete details and descriptive literature write:

CHEM-PLASTICS & PAINT CORP.
1828 Locust, St. Louis 3, Mo.

NEW EQUIPMENT

We have available MAGNETIC LEDGER CARDS for IBM 6400 systems. Any size available from stock. K Service, 95D High Street, Newark, N.J. 07104 Area code 201 623-8911.

DATAMATION

Classified Advertising

The classified section is open for the following advertising categories: Used equipment; positions wanted; help wanted, educational institutions; maintenance services; professional cards; hobby products; business opportunities and educational courses. Rates are based on total number of insertions used within each contract year.

Minimum for all advertising—1 column inch. Exception—for Situations Wanted we will accept 1/2 inch column. See rates below. Maximum vertical space—4 column inches*. Maximum horizontal 2 column inches deep. Larger units are billed at display rates. Rates for advertising (classified only).

1X 6X 12X

1 column inch . . . 40.00 37.00 34.00

* 1 column inch is defined as 1 column wide by 3/4" deep.

Classified rate cannot be earned in combination with display advertising.

Rates for Situation Wanted—payable in advance.

For Situations Wanted only:

1X 3X
1/2 inch column (4 lines of type) . . . 20.00 18.00
Plus \$2.00 for box number. Box number counts 1 line. Situations wanted accepted from individuals only.

Mechanical requirements:

1 column inch 2-3/16"

1/2 inch column 2-3/16"

Depth

3/4" (1 column width 2-3/16")

3/8" (2 column width 4-9/16")

Issuance and closing dates: Issued 15th of month. All copy must be in New York, N. Y., by 10th of preceding month. All copy subject to publisher's approval.

For further information please contact: DATAMATION Magazine, Classified Advertising Dept., 141 East 44th Street New York, N. Y. 10017—212-MU 7-5180.

Computer Systems Engineering Openings

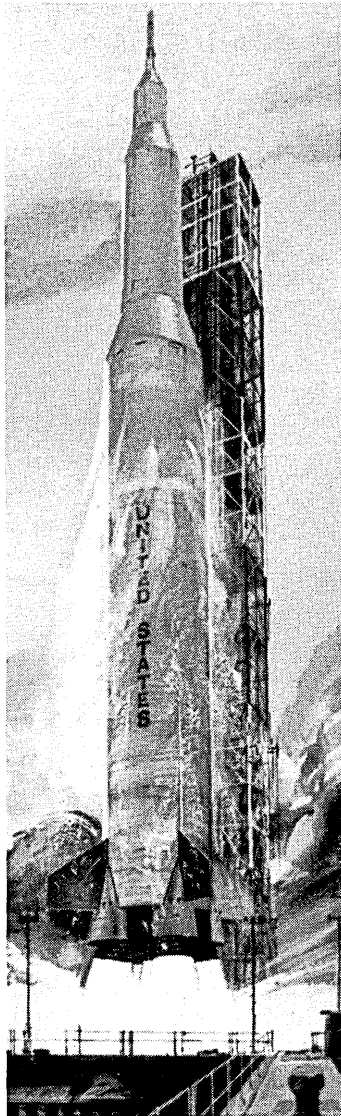
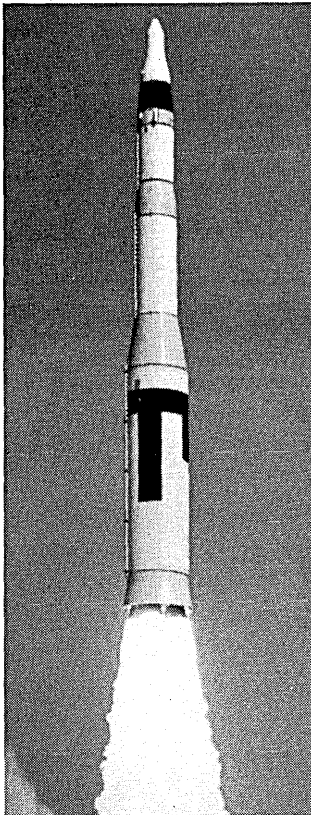
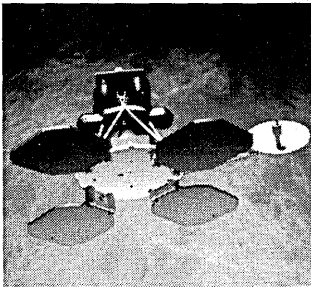

Computer Center, Seattle

The Boeing Company's Aero-Space Division — major contractor for the NASA Saturn V launch vehicle, USAF Minuteman ICBM and NASA Lunar Orbiter — has a number of challenging openings for qualified graduate computer systems engineers. Requirements are a B.S., M.S., or Ph.D. in engineering, physics or mathematics, preferably with experience in computer applications, computer systems analysis or related fields.

These assignments are at the Boeing Computer Center in Seattle, one of the largest and most complete industry computer facilities in the free world. Additional positions are available at Huntsville, Ala. and New Orleans, La.

Computer Applications — Develop digital computer systems for calculating trajectories and trajectory optimization, guidance and control, loads and stresses, and temperature distributions.

Design and implement real time and near real time spacecraft performance computer programs. Assignment will involve coordination with other contractors and participation in space flight control.

Analyze and design computer programs and information processing systems to be used in support of operational command and control systems. Experience in the fields of information retrieval or query languages is desirable.

Computer Systems Analysis — Evaluate, develop and implement programming languages and compiler systems for scientific computing systems. Experience in large scale systems, design and development of compilers or major applications programs is desirable.

Develop and implement software systems for small and medium size computers used for on-line data acquisition and processing, military and space systems simulation and crew training simulators.

Analyze and define the requirements for digital hardware systems, specify the computer configuration required and evaluate present and proposed systems in a continuing program to advance the Division's computing facilities.

Salaries are competitively commensurate with your experience and educational background. Travel and moving allowances are paid to newly hired personnel. Boeing is an equal opportunity employer and complies with the provisions of the Civil Rights Act of 1964.

Send your resume, today, to Mr. Lawrence W. Blakeley, The Boeing Company, Aero-Space Division, P. O. Box 3822 - DAD, Seattle, Washington 98124.

BOEING
AERO-SPACE DIVISION

BOOK REVIEW

The 1620 Revisited:

Programming the IBM 1620—the hands on approach, by Eric A. Weiss, McGraw-Hill, 1965.

Programming the IBM 1620, Second Edition, by Clarence B. Germain, Prentice-Hall, 1965.

There are now seven texts written around the 1620, the latest being that of Weiss. Mr. Weiss has been active in computing circles for many years and has had extensive experience both in day-to-day work (with Sun Oil) and in teaching adults and children. The experience shows in his book, giving an air of calm competence to every paragraph. The book fully lives up to its subtitle; at every step it stresses "Do this and this and this and see what happens." The things that are thus caused to happen include various blowups caused by common errors in coding.

The book deals in machine language for the first 40%, then proceeds through SPS to FORTRAN. The coverage of each of these phases is thorough without being formidable; indeed, the style is pleasantly conversational.

There are few errors, and those could be termed philosophical. For example, the admonition to check for a zero divisor *after* dividing is questionable, as is the advice to make fields generously large to avoid overflows. In general, however, the material is meticulously precise. The book's outstanding weakness is a complete lack of problems. It is loaded with exercises—all in the nature of finger exercises—but at no point is there the slightest indication of what a computer might be used for. Surely a student deserves some clue as to what he might do with his hard-won knowledge.

In sum, as an aid to learning the mechanics of operating the 1620, Weiss' book rates high. It is attractively presented, and is suitable for use at all levels, from high school through graduate school.

Germain's book is an improved ver-

sion of an established text. The pages have been retyped into a two-column format, and material has been added to cover the Model II features and all the peripheral gear.

Germain begins with a detailed discussion of the mechanics of the machine, then proceeds to FORTRAN (with lots of problems suggested) and hence to SPS. There is much reference material (e.g., a list of RPQ's and a price list of all components) not available elsewhere. Germain assumes a much more sophisticated background for his readers, including familiarity with the calculus. He also assumes that the student intends to do useful work with the machine. As a result, the student would have to furnish far more effort, with consequent greater rewards. ■

—FRED J. GRUENBERGER

DATA PROCESSING OPPORTUNITIES

PROGRAMMING SYSTEMS ANALYSIS MATH ANALYSIS INFORMATION RETRIEVAL OPERATIONS RESEARCH

Exceptional opportunities for professional advancement are yours for the asking if you have three or more years' experience in any of the above areas. Salary commensurate with experience. Fringe benefits.

Please send complete resume including salary requirements and geographic preference to the Director of Personnel.



CDI DATA

PROCESSING

CORPORATION

EXECUTIVE OFFICES: 4 Penn Center Plaza
Philadelphia, Pa. 19103

WEST COAST DIVISION: 15300 Ventura Blvd.
Sherman Oaks, Calif. 91403

MANAGER SCIENTIFIC DATA PROCESSING

Challenging assignment at the National Reactor Testing Station near Idaho Falls, Idaho, for a man with 5 to 10 years of experience in managing a scientific computing installation. This position entails supervision of a well established group of analysts and programmers who handle computer applications in the areas of reactor analysis, reduction of experimental data from reactor tests, statistical analysis, nuclear safety tests, and a variety of commercial data processing problems. presently installed equipment includes an 7040/1401 system, with a CDC-3100 on order. The computing load is 80% scientific, 20% commercial.

Candidates should have a PhD degree or equivalent outstanding experience. Salary commensurate with qualifications.

Contact

PHILLIPS PETROLEUM COMPANY

Atomic Energy Division
P. O. Box 2067-KF
Idaho Falls, Idaho

An equal opportunity
employer.

U. S. citizenship
required.

CIRCLE 103 ON READER CARD

CIRCLE 104 ON READER CARD

PROGRAMMERS

In developing systems which provide information processing assistance, SDC programmers, system analysts, engineers and human factors scientists have evolved an interdisciplinary approach. Teams work together in major system development steps: analyzing the system, synthesizing the system, instructing computers within the system, training the system, evaluating the system — and helping adapt the system to the changing needs of its users.

Space Programs

Assist in design, development and integration of computer programs for satellite detection and tracking network. Areas of activity include astrodynamics . . . ephemeris calculations . . . telemetry . . . error detection, analysis and correction of operational EDP control systems. Minimum of two years' experience in machine language programming on CDC 1604/160A and/or 3600 required. Experience in production, integration, testing and demonstration of large military data processing systems is desirable.

Defense Systems

Participate in the design and development of system operational specifications and computer programs for large-scale military defense systems and real-time command and control systems. Experience with more than one large-scale computer utilizing higher order programming language in addition to machine language is required.

Advanced Technology

Positions exist in research and development at advanced degree levels, with some related experience required. Areas of activity include natural language processing . . . machine translation . . . time-sharing . . . development of higher order programming languages . . . compiler development . . . and database manipulation and retrieval.

Those interested in joining this growing field are invited to write to Mr. A. C. Granville, Jr., SDC, Dept. DA08, 2500 Colorado Avenue, Santa Monica, California. SDC is an equal opportunity employer, and a plans for progress company.

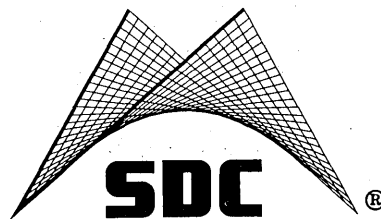

SYSTEM DEVELOPMENT CORPORATION

CIRCLE 105 ON READER CARD

(Continued from page 69)

installations and a backlog of orders, Burroughs is turning on the heat. Deals are being made in the U.K. with service bureaus on a country-wide basis, the latest being in London. Known as Randex-EDP, it will provide an on-line inquiry service using big disc files. Manufacture of the E1000 dp system has also started in Scotland. After 15 years of experience manufacturing in the area, Burroughs has already shown that it can land calculating machines in New York 30% cheaper than if they were made in the U.S., including freight.

AUTOTANK

Credit card facilities are not used so widely in Europe as in the States, so data processing at the gas station takes a different form. In Sweden it's an automatic vending approach developed by AB Autotank. Equipment comprises an optical character reader that will identify Kroner notes and control the pumping system. Svenska Shell plans to install 25 of these machines in an attempt to increase sales through unmanned gas stations.

AUSTRALIANS, TOO, WORRY
ABOUT WARM BODIES

An edp careers committee in Sydney estimates that 1000 graduates and 2000 nongraduates will be needed for the computer industry in Australia by '66. Census shows 3000 analysts and programmers now employed for the 300-plus computers installed and on order. The growth rate exceeds 30% per year and the staff crisis is worsening.

U.K. STEELMEN LEAD
IN PROCESS CONTROL USE

According to a computer survey prepared by the British Iron and Steel Federation, U.K. steelmakers use more machines for on-line control per ton output than anywhere else in the world. At the end of '64, world steelmen had 103 process systems on order or installed, 54 in the U.S. and 17 in the U.K.

TWO AIRLINES CONTRACTS
REMAIN IN EUROPE

IBM is tipped to take a \$9-million contract from British Overseas Airways Corp. for a total management system covering finance and accountancy control to crew and repairs scheduling. Expected is an international hook-up with two 360/50's in London and two 40's in New York. Main competition for the job came from Univac with a big installation already working in the other state airline, BEA. Although some argument prevails on the merits of compatibility between the two organizations, IBM is believed home and dry except for the final rubber stamp of approval. Competition for airlines business in Europe has been intense. The final plum is Europe's largest operator, Air France. The line-up looks like 1108's versus big 360's although Siemens is now making an effort in France; GE-Bull may pull a surprise.

ODDS & ENDS

September is rumored announcement date for a new range of English Electric-Leo-Marconi computers. Expected is an integrated circuit line, with IBM compatibility in mind. Reports have already suggested that RCA Spectra ideas (available under an English Electric-RCA cross-licensing agreement) and Marconi Myriad experience will be combined in a \$100,000 to \$2 million range...Also rumored from EMI Electronics for 1966 are a commercial range of thin film stores from 4K upwards at a cost of seven cents a bit.

HARVARD UNIVERSITY

COMPUTING CENTER

Expansion of Computing Center services has created permanent positions for senior applications and systems programmers with 7094 experience in:

- real time
- multiprogramming
- multivariate statistical analysis

Opportunity to plan and execute major new systems and applications:

Resumes acknowledged and handled in confidence.

Mail to: Dr. Norman Zachary, Manager
Harvard Computing Center
Harvard University
33 Oxford Street
Cambridge, Massachusetts 02138

An Equal Opportunity Employer

CIRCLE 108 ON READER CARD

FREE

—a comprehensive digest of scientific and engineering DATA PROCESSING opportunities for our client organizations from coast to coast. These opportunities include such areas as:

Basic Research	Diagnostic Programming
Command and Control	Ballistics
Communications	Logistics
Operations Research	Simulation
War Gaming	Information Storage and Retrieval
Transportation	Character Recognition
Software Development	

As specialists in the scientific and engineering field, EDP is able to provide the widest possible selection of career positions. Each allows the individual to make significant contributions to applications that will challenge his best efforts, in a scientific atmosphere, at a salary in keeping with technical competence.

Please write for FREE Digest of Scientific openings.

For immediate consideration, write in confidence outlining your experience, education, career objectives, and compensation requirements to:

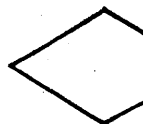

David N. Grimes
edp personnel, inc.
"exclusively data processing"

100 S. Wacker Drive Suite 212
Chicago, Ill. 60606 Ph. (312) 782-0857

CLIENT COMPANIES ASSUME OUR CHARGES

CIRCLE 107 ON READER CARD

COMPUTER ENGINEERS

Are you making enough money?

Fast-changing personnel requirements within the computer industry are of vital importance to every computer engineer.

Are you over-specialized? Is your experience becoming more valuable, or heading you toward mid-career obsolescence? Are your earnings below or above-average?

The answers to these and other career-oriented questions can only be obtained through an intimate knowledge of the professional recruiting practices of all major computer manufacturers.

This is the business of R. W. Reilly Associates: Manpower recruiting consultants to the computer industry. All our fees are paid by the companies who retain us. We never refer a resume without prior consent by the candidate.

To determine your own position within the industry, you may circle the reader service card number below, send your inquiry, with or without a resume to the address nearest you, or call (collect) any weekday during business hours.

R.W. Reilly & Associates

Pan Am Building
Suite 303 East
200 Park Avenue
New York, New York
(212) PLaza 1-0650

28 East Jackson Blvd.
Chicago, Illinois
(312) 427-2036

Nine Chester Street
Cambridge
Massachusetts
(617) 868-4993

2570 Bush Street
San Francisco, California
(415) WEst 1-0601

Client Company is an Equal Opportunity Employer

CIRCLE 106 ON READER CARD

DATAMATION

Air Traffic Control

people needed in MITRE's Washington, D.C. office to provide system engineering assistance to the Federal Aviation Agency. Work areas include broad level system design, computer program operational specification, configuration management, system integration and system test planning.

Communications

people needed who can help conceive new communications systems, recommend development programs, and analyze special communications requirements generated by new systems concepts. Work areas include systems planning, range instrumentation, tactical air control and survivable communications.

National Military Command System

people needed for systems analysis and feasibility studies, communications systems analysis, systems design, integration, and verification.

Sensor Systems

people needed to support theoretical and experimental programs on advanced radar and optical detection and tracking systems; feasibility and technique analysis, systems synthesis and performance evaluation.

Computer Programming

people needed with experience in the development and support of monitors, compilers, real-time simulations, time-sharing systems, etc.

Systems Analysis

people with experience in military systems or operations analysis with a background in physics, mathematics, operations research, or industrial management.

Systems engineers needed for work on these vital projects



MITRE works on the basic design and general system engineering of complex information, control, sensor, and communications systems of national importance. An important part of its mission is the development of new techniques in these areas and advancement of the general technology. If you have three or more years' experience and a degree in electronics, mathematics or physics, write in confidence to Vice President — Technical Operations, The MITRE Corporation, Box 208AU, Bedford, Mass.

Pioneer in the design and development of command and control systems, MITRE was chartered in 1958 to serve only the United States Government. An independent nonprofit corporation, MITRE is technical advisor and systems engineer for the Electronic Systems Division of the Air Force Systems Command, and also serves the Department of Defense, and the Federal Aviation Agency.

THE
MITRE
CORPORATION
An Equal Opportunity Employer

AEROJET-GENERAL

California

Von Karman Center

(25 miles east of Los Angeles)
and

Sacramento Facility

(Northern California)

Have immediate openings for:

PROGRAMMING SPECIALISTS

Positions are for Senior and Principal Programmers in the Data Processing Centers who have large scale computer experience and knowledge of COBOL. Bachelor's degree preferred.

U.S. Citizenship Required

For information, send a personal resume to:
Mr. R. S. Lawrence . . . P. O. Box 303 D

Azusa, California

A subsidiary of the
General Tire & Rubber Company
an equal opportunity employer



CIRCLE 111 ON READER CARD

SYSTEMS PROGRAMMERS

If you are interested in working on operating systems or the development of advanced programming systems for the next generation of Burroughs computers, we invite you to look into the career opportunities at Burroughs. We are already doing what others are talking of doing for the first time. We can provide an important part of your career development . . . the opportunity to work with competent programmers, who have demonstrated their ability in advanced work.

We have positions for experienced programmers at various levels, including senior level positions, concerned with the development of and implementation of automatic programming systems. For information, write:

MR. F. P. WILSON

Professional Employment

Burroughs
Corporation



460 Sierra Madre Villa

Pasadena, California 91107

An equal opportunity employer

CIRCLE 112 ON READER CARD

PROGRAMMERS • ANALYSTS • ENGINEERS

Our clients offer immediate professional career opportunities to qualified men who are ready to further their goals.

Locations are currently available in New England, New Jersey, Philadelphia, Washington, D.C., Florida, Southwest and the Midwest.

Consult with us to plan the full use of your professional potential—whether at Junior, Senior or Management levels. Important assignments require experience and interest in any of these areas:

- Scientific Programming
- Digital or Logic Design
- Real Time Systems
- Circuit Design
- Software Development
- Commercial Programming
- Operations Research
- Mathematics
- Applied Systems
- Development Engineering
- Systems Design
- Communications

Starting salaries range to \$25,000, according to your experience level; all fees and expenses are assumed by our client companies. Please forward your resume in strict confidence, including salary and geographic preference, directly to Mr. R. L. Keilholtz or Mr. Donald Wayne.



EVERETT KELLEY ASSOCIATES

Consultants to the Computer Industry

121 So. Broad Street (Suite 1300) Philadelphia, Pa. 19107



ADVERTISERS' INDEX

AC Electronics Division of General Motors	88
Acme Visible Records, Inc.	73
Adage, Inc.	1
Advanced Scientific Instruments Subsidiary of Electro-Mechanical Research	16
Aerojet-General	106
Albert, Nellissen, Inc.	96
American Telephone & Telegraph Co.	62
Ampex Corp.	Cover 2
Anelex Corporation	78
Bellcomm, Inc.	76
The Boeing Company, Aero-Space Division	100
Bryant Computer Products, A Division of Ex-Cell-O Corporation	22
Burroughs Corporation	59, 61, 63, 65
Burroughs Corporation, Electrodata Division	106
Collins Radio Company	94, 95
Comprehensive Designers, Inc.	101
Computer Sciences Corporation	87
Computron Inc.	6
Consolidated Electrodynamic	84
Costello & Company	82
Contemporary Electronics	75
Dashew Business Machines	4
Data Packaging Corporation	Cover 3
Dataman Associates	98
The Datamart	99
DATAMATION Magazine	93, 97
Datamec Corporation	14
Digital Electronic Machines, Inc.	85
Digitek Corporation	83
E. I. du Pont de Nemours & Co. (Inc.)	15
EDP Personnel, Inc.	104
Electronic Associates, Inc.	68
Electronic Engineering Company of California	10
Engineered Electronics Co.	74
Fabri-Tek, Inc.	54, 55
Fairchild Semiconductor	20
Ferroxcube Corporation of America	Cover 4
General Precision Inc. Librascope Group	12
Harvard University	104
Honeywell Electronic Data Processing	39, 89
IBM	8, 9, 108
Everett Kelley Associates	106
La Salle Associates	107
Lawrence Radiation Laboratory	107
Lockheed Missiles & Space Company	96
McDonnell Automation Center, Division of McDonnell Aircraft	18
Memorex Corporation	35, 36
Micro Switch A Division of Honeywell	64
The Mitre Corporation	105
Monroe Data/Log Division of Litton Industries	13
Moore Business Forms, Inc.	2, 3
The National Cash Register Company, Electronics Division	80, 81
The National Cash Register Company	60
The Northern Trust Company Bank	67
Photocircuits Corporation, Tape Reader Division	86
City of Philadelphia	93
Phillips Petroleum Company, Atomic Energy Division	101
Port Huron Paper Company	52
Raytheon	57
R. W. Reilly and Associates	104
Scientific Data Systems	66, 97
Snelling and Snelling	67
Standard Packaging Corporation	11
The Standard Register Company	5
Steelcase, Inc.	53
Stromberg-Carlson Corp., San Diego, California	72
System Development Corporation	102
Systems Research Group, Inc.	73
UGC Instruments, Inc.	56
URS Corporation	93
VISRecord Inc.	40
Wolf Research and Development Corporation	92
Wright Line	77, 87
Wyle Laboratories	70

FREE! CAREER OPPORTUNITIES BULLETIN

A complete and comprehensive listing of outstanding positions at salaries from \$6,000 to \$30,000 with National Companies for:

ENGINEERS / DATA PROCESSING

Our professional staff combines Customized Service with technical know how to insure for you maximum career development in the following areas:

- LOGIC DESIGN
- APPLICATIONS PROGRAMMERS
- CIRCUIT DESIGN
- SYSTEMS DESIGN
- SYSTEMS ENGINEERS
- SYSTEMS PROGRAMMERS
- OPERATIONS RESEARCH
- INFORMATION RETRIEVAL
- PROGRAMMING
- MATH ANALYSIS

No charge to you for our custom service. Employers pay our fee. Expedite your development by sending resume in confidence with present salary & geographic preference to:



La Salle Associates

Professional Search Dept.
2136 Locust Street, Philadelphia, Pa. 19103

For your free bulletin without any obligation, circle subscriber service card.
Please use home address only.

CIRCLE 113 ON READER CARD

University of California LAWRENCE RADIATION LABORATORY Livermore, California

Major nuclear research and development laboratory offers challenging assignments in the area of advanced management information systems utilizing latest data transmission techniques.

SYSTEMS AND DATA PROCESSING MANAGER

To supervise and direct our management systems group and the operations of an EMP service center. Preference will be given to applicants with MBA, a scientific or engineering background, 5-10 years experience in business systems development, 2-3 years of which have been in a supervisory capacity, and substantial knowledge of high speed computers and related equipment.

MANAGEMENT SYSTEMS ENGINEERS

To design advanced information systems and models; appraise computer techniques and equipment as well as operations and logic. Preference will be given to applicants with MA or MS degree and experience in latest computing techniques.

MANAGEMENT SYSTEMS PROGRAMMERS

Requires knowledge of FORTRAN and similar symbolic languages. Should also be familiar with SIMSCRIPT, GPSS and other advanced languages. Facilities include IBM 1401, 7094, STRETCH; LARK; CDC 3600, 6600; and other related equipment. Preference will be given to applicants with BA or BS degree with substantial math background.

Send inquiries and/or resume to:

Mr. George S. Kumarak
Personnel Department

LAWRENCE RADIATION LABORATORY

P.O. Box 808 21.85
Livermore, California 94551

U. S. Citizenship Required

An Equal Opportunity Employer

CIRCLE 114 ON READER CARD

A partial list of the 28 papers presented by IBM'ers at IFIP Congress 65: *The Past, Present, and Future of Simulation Languages*—R. A. Merkallio • *Advanced Concepts of Utilization of Mass Storage*—C. B. Poland • *A Possible Future System for Automating Control of the Development, Distribution, and Maintenance of Programming Systems*—W. R. Crowley • *Improved Technical Library Operation through Statistical Reporting by Computers*—B. E. Lamkin • *Dynamic Control of Core Memory in a Real-Time System*—G. J. Evans, Jr., and W. B. Elmore • *Notation, Insight, and Problem Definition Methods*—M. S. Montalbano • *Use of Computers for Doing Non-Numerical Mathematics*—J. E. Sammet • *Some Algebraic Techniques for the Organization of File Data*—C. T. Abraham • *Static and Dynamic Models*—J. C. R. Lickliger • *Testing Requirements on a Real-Time System*—J. T. Martin • *Methods for Analyzing the Effects of Preventive Maintenance on System Reliability*—B. J. Flehinger • *Structure of Sequencing Algorithms for Simulation*—B. M. Leavenworth and R. J. Parente • *Maximization of a Concave Function Under Linear Constraints*—J. M. Gauthier • *On-Line Processing of Library Materials on the IBM Administrative Terminal System*—T. D. Phillips • *The Use of Fault Location Tests in Prototype Bring-Up*—R. J. Preiss • *Long-Range Planning Techniques for Discrete Production Operations*—A. B. Calica

That's the Way to Start a Recruiting Ad?

We think it is. We think it speaks volumes for the kind of atmosphere programmers, systems analysts, and other professionals find at IBM. *Opportunity for recognition. Creativity. Individuality. Professional and personal advancement.* Those are all well-worn words,

but they take on fresh life and real meaning at IBM. Not only for those

who present papers at technical conferences, but for the IBM professionals at all levels who are helping to solve some of the most challenging problems in advanced information-handling technology today. This kind of environment can bring out the best of *your* talents and abilities and can add significantly to your professional worth.

Investigate the advantages of the growth environments at IBM's Systems Development Division in Poughkeepsie, New York, and the Federal Systems Division's centers in Bethesda, Maryland; Houston, Texas; and Los Angeles and Palo Alto, California. The positions listed below represent only a few of the many immediate openings available at IBM. To inquire about additional career positions at other IBM locations in Alabama, California, Massachusetts, Nebraska, New York, and Virginia, please write in complete confidence, outlining your interests and experience, to Manager of Professional Staffing, Dept. 701H, IBM Corporate Headquarters, Armonk, New York 10504. IBM is an Equal Opportunity Employer.

Systems Development Division

Programming Systems Testing. Develop new techniques for testing systems, evaluating performance, and coordinating systems development. Involves systems generation, editing, and related test activity.

Programming Evaluation. Write tests to evaluate and improve systems performance. Requires experience on medium-to-large computers and familiarity with COBOL, FORTRAN, assembler sort, or control systems.

Supervisory Programs. Develop control program functions, including systems supervisor, symbolic I/O interrupt control, machine control, stack-job scheduling IOCS, data management, time-sharing in peripheral I/O multiprocessing.

Programming Languages. Write compilers for assembly language, FORTRAN, COBOL, and PL/I.

Business-Oriented Programming. Develop advanced sort-merge techniques, report generators, and file maintenance programs.

Write to: A. E. Short, Dept. 701H, IBM Corporation, Box 390, Poughkeepsie, New York.

Federal Systems Division

Real-Time Scientific Systems Programmers. For manned space exploration and scientific satellite projects: Analyze and develop operational, executive, network data generator, and simulation programs in real-time space systems.

Information Retrieval Systems Programmers. For command, intelligence, and logistic projects: Apply statistical, file-formatting, editing, and retrieval techniques for analysis and development of programs in real-time information retrieval and data reduction systems.

Management Information Systems Programmers. For advanced management data systems: Develop and apply formatted file, editing, and retrieval techniques in programs handling economic, personnel, project performance, and medical information. Requirements: B.S. or B.A. degree or equivalent, with at least one year's experience designing computer systems or programs.

Write to: W. R. Van Eysden, Dept. 701H, IBM Corporation, 7220 Wisconsin Avenue, Bethesda, Maryland.

IBM

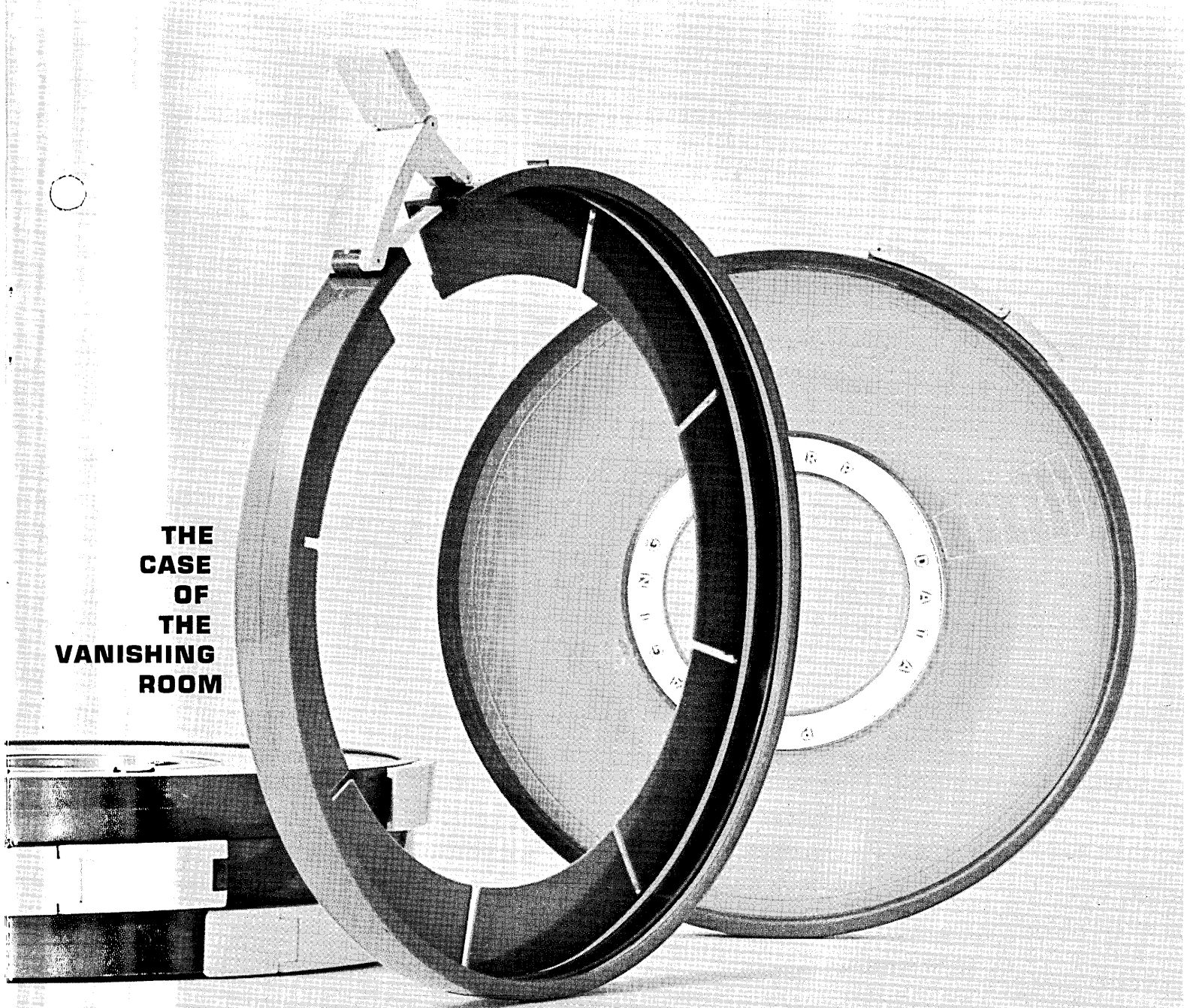

**THE
CASE
OF
THE
VANISHING
ROOM**

Here is a new tape storage case that saves important space, protects important data, and can be effectively used by real people working with real computers. Consider this:

You get 50% more storage because cases are thinner, it's even possible to use existing racks and cabinets. Case is always a circle, quick, easy to use. Place the reel against the shelf-back of the case, flip the lock. That's all. Reel is self registering to inner and outer rim. A stacking feature permits orderly storage on the desk, whether reel is in or out of case. Stacks on the arm, too, for quick computer changes. They're rugged. Cases are rigid, unbreakable when dropped, made of LEXAN[™], hinged at lock with metal pins. Dual rubber seals mean best protection against tape contamination, better by far than any other space-saving case.

This new case is available from most every computer and tape manufacturer with their reels of tape. A ring of color around the hub of the reel identifies it as a quality reel with an aluminum winding surface from

DATA PACKAGING CORPORATION
205 Broadway, Cambridge, Massachusetts

Design and mechanical patents applied for.
LEXAN is a trade mark of General Electric Corporation.

CIRCLE 2 ON READER CARD

•
•
•

Let us take you down memory lane.

Before there could be ferrite cores there had to be ferrites.

Philips of the Netherlands developed the first ferrites.

Then Philips uncle'd us

and together we made the first 30 mil cores.

Then we made the first 20 mil cores.

Then we learned to string them before anyone else did.

**Then we learned to string them more reliably
than anyone else could,**

**(so reliably that in a recent order for stacks
containing 136 million cores, only 3 stacks
were returned for individual core malfunctions.**

3 out of 136 million.)

It's taken us only 4 years to get this good.



FERROXCUBE CORPORATION OF AMERICA

Saugerties, New York

CIRCLE 3 ON READER CARD