

# 70 DATAMATION®

*February*

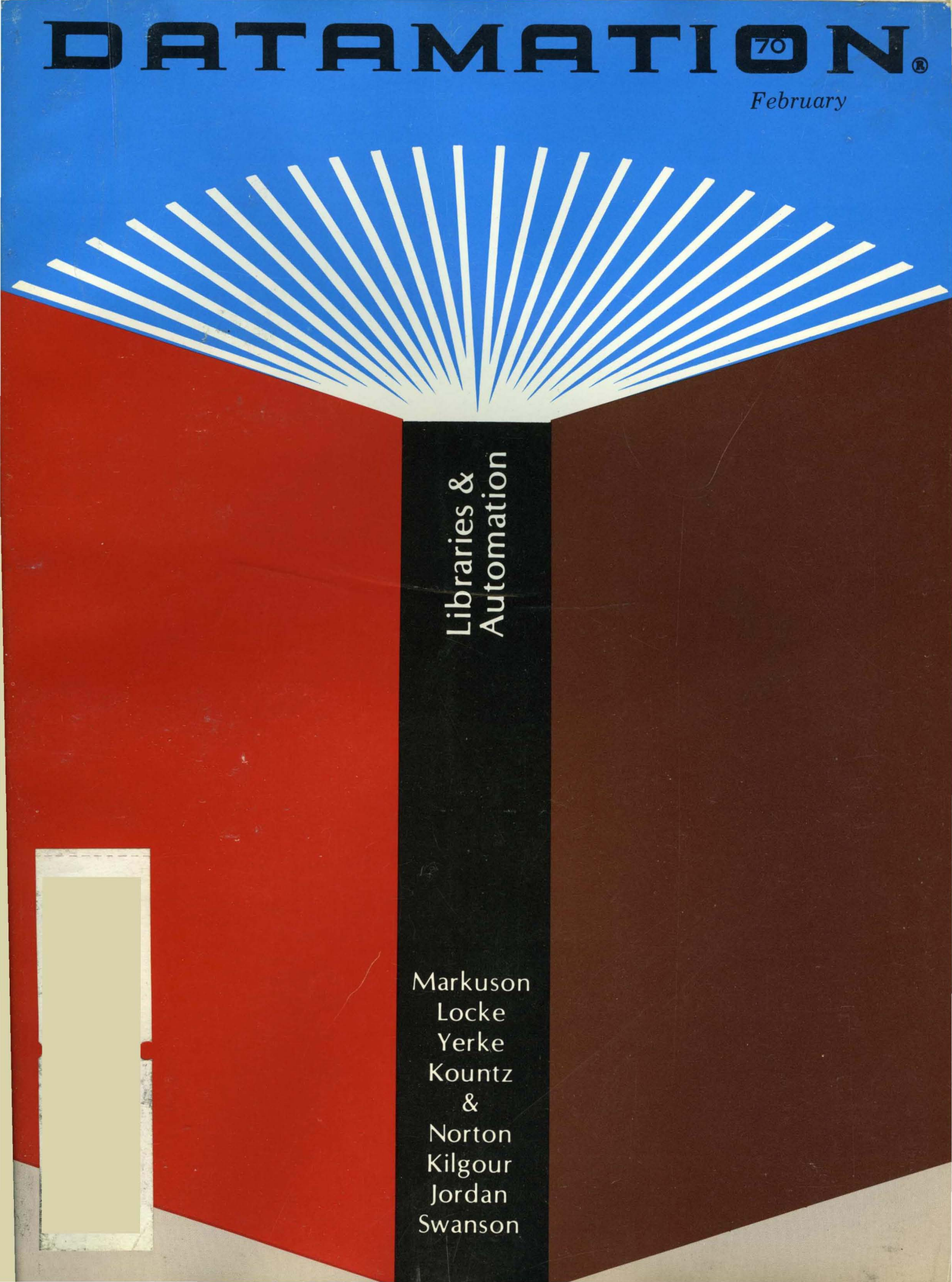

Libraries &  
Automation

Markuson  
Locke  
Yerke  
Kountz  
&  
Norton  
Kilgour  
Jordan  
Swanson



**Try dropping  
this  
in your  
computer!**

Antienvironment is the name of Varian's latest computer game. We call it the R-620/i, a ruggedized version of the popular 620/i (over 1000 sold worldwide).

The new R-620/i is a systems-oriented, general-purpose computer that offers highly reliable operation in the most severe environments. It is specifically designed to withstand vibration, shock, humidity, dust and corrosion. Ideal for mobile or permanent facilities in both military and industrial applications.

With ceramic integrated-circuit reliability, the computer features easy interfacing, compactness, choice of 16- or 18-bit precision and a high-temperature memory that can be expanded up to 32K words.

A large library of software, field-proven on the functionally identical 620/i, is available to you for the R-620/i. As well as one of the largest service and main-

tenance organizations in the small-computer field. The price is only \$16,900. The R-620/i, a good new reason for you to talk to the big company in small computers.

U.S. Sales Offices: Downey, San Diego, San Francisco, Calif.; Washington, D.C.; Atlanta, Ga.; Chicago, Ill.; Waltham, Mass.; Ann Arbor, Mich.; New Rochelle, N.Y.; Fort Washington, Pa.; Houston, Tex. Other offices worldwide.

Varian Data Machines, a Varian subsidiary,  
2722 Michelson Dr., Irvine, Calif. 92664.  
Telephone: 714/833-2400.



**varian  
data machines**

**The Big Company in Small Computers**

CIRCLE 1 ON READER CARD

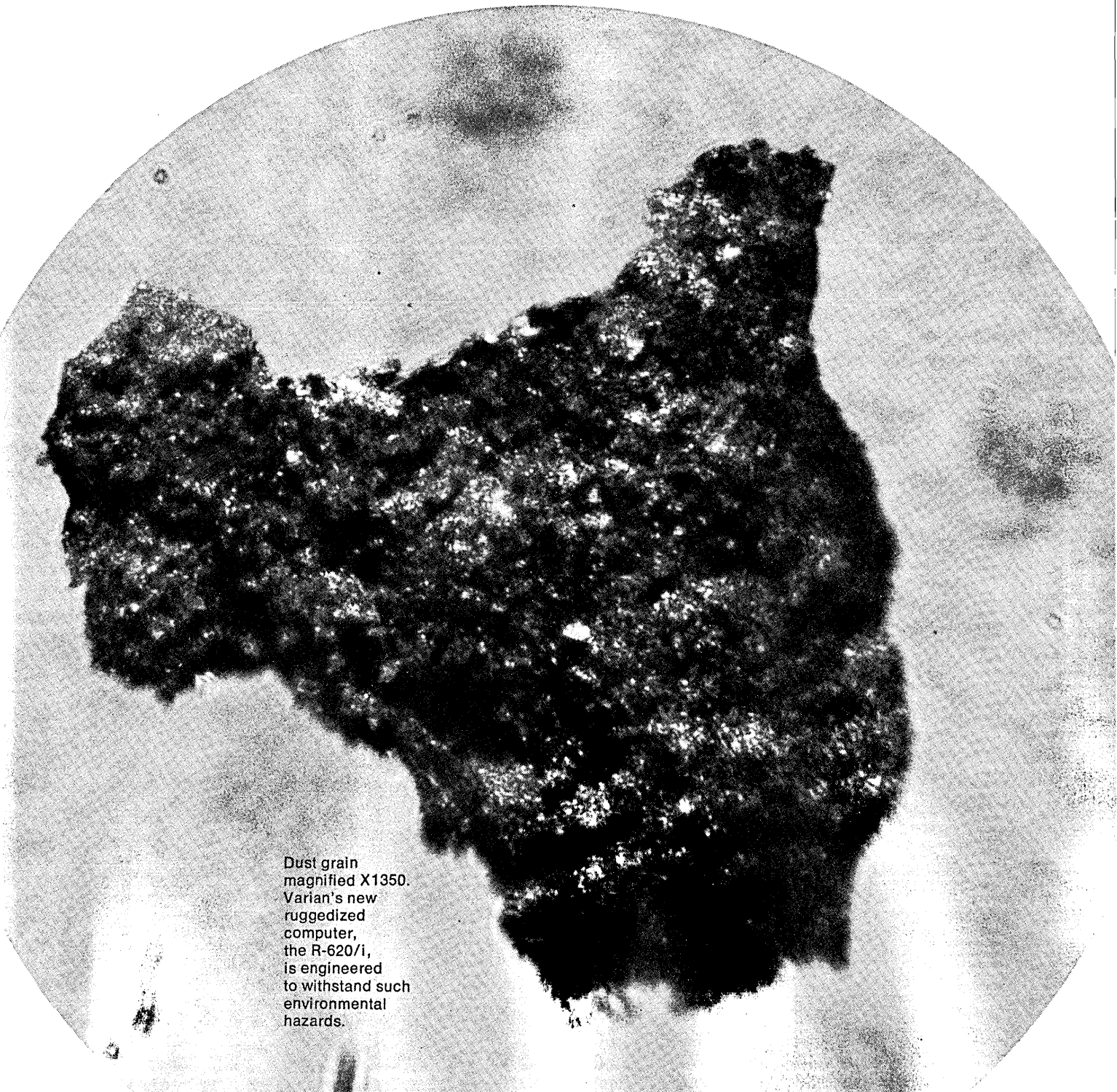

Dust grain  
magnified X1350.  
Varian's new  
ruggedized  
computer,  
the R-620/i,  
is engineered  
to withstand such  
environmental  
hazards.



# PRESENTING THE **TALLY BATCH TERMINAL**

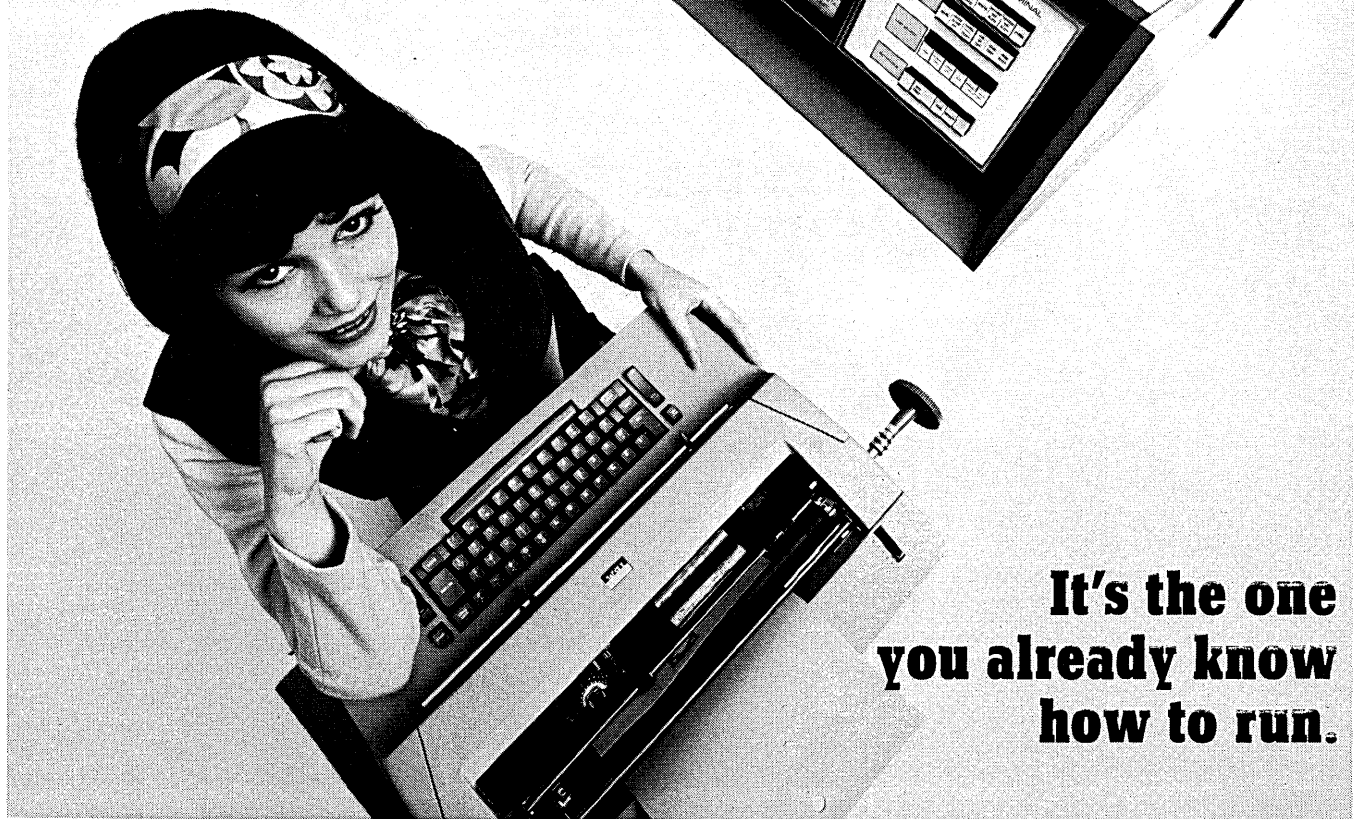

**It's the one  
you already know  
how to run.**

Everybody who types already knows how to run the fastest batch terminal on the market. As a non-labor byproduct of your regular office typing routines, data is entered on the Tally 1021 Batch Terminal.

At the end of the day or any other convenient time, you can transmit at 1200 words per minute to any size computer. The Tally 1021 Batch Terminal gives you full error control, variable record length, reuse-

able media, two way communication, code flexibility, simplicity of operation, proven reliability, and operating economies. Options include computer interface, paper tape reader, cardreader, and computer compatible mag tape recorder.

Your Tally Batch Terminal comes with the works, all tape formatting, parity checking, switching, and tape control functions. As a matter of fact, all you add is the girl.

 **TALLY**

*For complete information, please write or call Tally Corporation, 8301 South 180th Street, Kent, WA 98031. Phone (206) 251-5500. TWX 910-423-0895. Or contact one of the regional offices: New York: 45 N. Village, Rockville Centre, NY 516-678-4220. Chicago: 33 N. Addison Rd., Addison, IL 312-279-9200. Seattle: 8301 South 180th St., Kent, WA 206-251-5500. England: 6a George Street, Croydon, Surrey (01) 686-6836.*

CIRCLE 54 ON READER CARD



# If you're looking for a solution to your data communications problems...

Look for a company that listens. Analyzes. And comes up with a *system solution*. Not just hardware.

At Sanders, we start with a team of the smartest data communications specialists around.

The same team that helped solve a reservations problem for a major airline. Here, the solution produced one of the fastest computer reservation systems in the airline business.

The same team that helped design a data communications system for a bank that is among the nation's largest custodian and transfer agents for mutual funds.

Here, the system keeps several million shareholder accounts up-to-the-minute.

And another system for one of the nation's largest insurance companies. And one for a major municipality.

Sanders furnished the complete package. Systems analysis. Engineering. Installation. Maintenance. Field support. Software. And hardware.

Although it's only part of a Sanders system, our hardware plays its own role in giving you a head start. The SANDAC\*200 Programmable Communications Processor, for example, is installed and solving

communications problems *today*. The only programmable communications processor offering proof, as well as promises.

Complete systems responsibility. Superior hardware and software. Where else can you find as powerful a combination?

Look ahead. For information, contact Marketing Manager, Data Communications Systems Group, Sanders Associates, Inc., Daniel Webster Highway, South, Nashua, N.H. 03060. Or call (603) 885-4554.



\* I.M. Sanders Associates, Inc.



look  
behind the  
hardware.

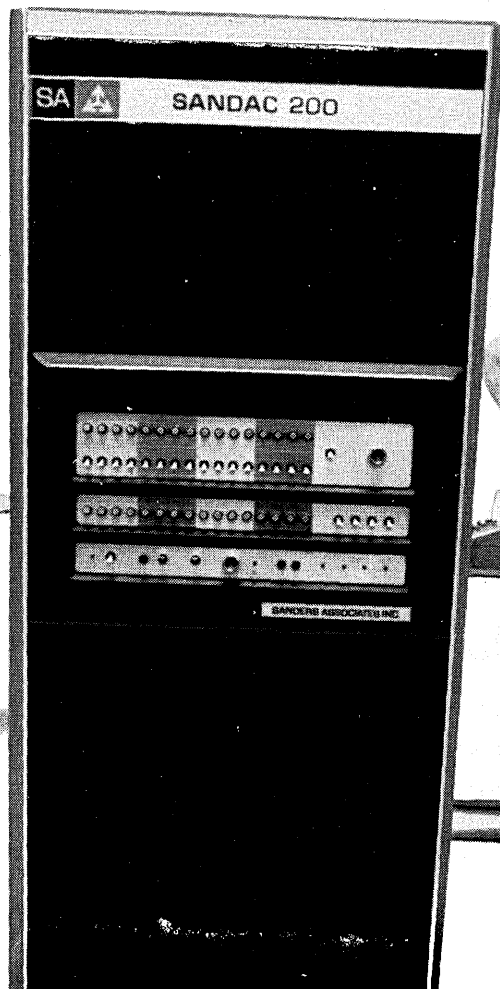
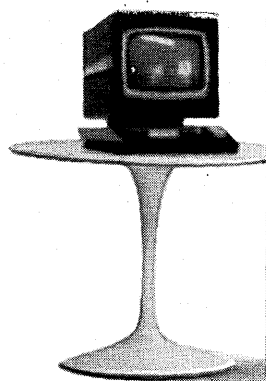



The most useful and practical reference on management information systems ever published

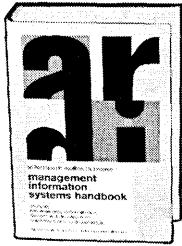

# MANAGEMENT INFORMATION SYSTEMS HANDBOOK

W. Hartman, H. Matthes, A. Proeme  
Sponsored by the  
Philips' Data Systems Division

All the instructions, flow charts, checklists and forms you need for building your information system are provided in this superbly organized master reference, which summarizes everything that is known on the subject in one meticulous handbook. It spotlights—point by point—the basic ground rules as culled from the vast knowledge and practical experience of thousands of experts who have grappled with every aspect of systems and computer applications. Based on the new ARDI concept of systems engineering, the handbook provides you with a network covering every systems activity from the definition of your problem to the selection of the best programming language.

“Valuable, if not priceless, to anyone assigned to develop a new application for an existing computer.”—*John Markus*, author of *ELECTRONICS AND NUCLEONICS DICTIONARY AND SOURCEBOOK OF ELECTRONIC CIRCUITS*

750 pages, hundreds of tables, charts and diagrams,  
**\$29.50**

At bookstores  
or send coupon today for

## 10 DAYS' FREE EXAMINATION

McGraw-Hill Book Company, Dept. DTM-270  
330 West 42nd Street, New York, N.Y. 10036

Please send me the **MANAGEMENT INFORMATION SYSTEMS HANDBOOK** (269571) for 10 days on approval. In 10 days I will remit \$29.50 plus a few cents for delivery and local tax, if any, or return the book postpaid.

Print Name \_\_\_\_\_

Address \_\_\_\_\_

City \_\_\_\_\_ State \_\_\_\_\_ Zip \_\_\_\_\_

This offer good in the U. S. and Canada only.  
**DTM-270**

CIRCLE 128 ON READER CARD

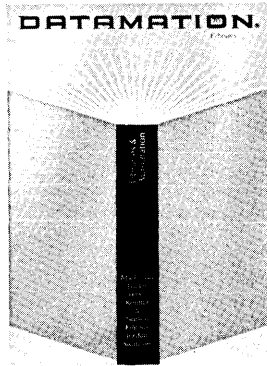

# february

1970

volume 16 number 2

Publisher  
Editor

**GARDNER F. LANDON**  
**ROBERT B. FOREST**

*Managing Editor* **EDWARD K. YASAKI**  
*Art & Production Director*  
**CLEVE MARIE BOUTELL**  
*Senior Associate Editor* **WILLIAM J. ROLPH**  
*Associate Editors* **AUBREY DAHL**  
**RICHARD A. McLAUGHLIN**  
*Assistant Editors* **JANET EYLER**  
**ANNE WILKS**  
*Special Features Editor* **ANGELINE PANTAGES**  
*Eastern Editors* **JOHN WESSLER**  
**F. BARRY NELSON**  
**WILLIAM A. J. FAY**  
*Midwestern Editor* **LAWRENCE RAGAN**  
*Washington Editor* **PHIL HIRSCH**  
*European Editor* **PEARCE WRIGHT**  
*Australian Editor* **FREDERICK A. BLAND**

*Editorial Assistants* **MERRILYN DAHL**  
*Contributing Editors* **HOWARD BROMBERG**  
**ROBERT V. HEAD**  
**PHILIP H. DORN**  
**LOUIS B. MARIENTHAL**  
**DANIEL D. McCracken**  
**F. G. WITTINGTON**  
**PAUL ARMER**  
*Editorial Adviser* **ROBERT L. PATRICK**  
*Technical Consultant* **LOWELL AMDAHL**  
*Production Manager* **MARILEE PITMAN**  
*Production Assistant* **GLORIA CASTAGNA**  
*Director of Circulation* **FRANK DeCARLO**  
*Circulation Manager* **MAE VAN RENNES**  
*Marketing Research Director*  
**DOUGLAS DeCARLO**

## ADVERTISING OFFICES

*Sales Manager & Vice President* **JOHN BRENNAN**  
205 West Wacker Drive, Chicago, Ill. 60606  
(312) Financial 6-1026

*Eastern District Managers* **JAMES M. MORRIS**  
**WARREN A. TIBBETTS**  
**IRWIN L. WERFEL**  
35 Mason Street, Greenwich, Conn. 06830  
(203) 661-5400

*New England District Manager & Vice President* **WARREN A. TIBBETTS**  
112 West Haven Rd.  
Manchester, N.H., 03104 (603) National 5-9498

*Midwest District Manager* **JOHN M. GLEASON**  
205 West Wacker Drive, Chicago, Ill. 60606  
(312) Financial 6-1026

*Western Manager & Senior Vice President* **HAMILTON S. STYRON**  
94 So. Los Robles Ave.,  
Pasadena, Cal. 91101 (213) 795-9721  
(213) 681-8486—from Los Angeles

*Western District Manager* **JAMES E. FILIATRAULT**  
260 Sheridan Ave.  
Palo Alto, Calif. (415) 321-1440

## EDITORIAL OFFICES

94 So. Los Robles Ave.  
Pasadena, Calif. 91101

## CIRCULATION OFFICES

35 Mason Street  
Greenwich, Conn. 06830



Circulation audited by  
Business Publications Audit



Member,  
American Business Press, Inc.

DATAMATION is published monthly on or about the tenth day of every month by F. D. Thompson Publications, Inc., Gardner F. Landon, Chairman and President; Gilbert Thayer, Senior Vice President. Executive, Circulation and Advertising offices, 35 Mason Street, Greenwich, Conn. 06830 (203) 661-5400. Editorial offices, 94 So. Los Robles Ave., Pasadena, California 91101. Published at Chicago, Ill.

DATAMATION is circulated without charge by name and title to certain qualified individuals who are employed by companies involved with automatic information handling equipment. Available to others by subscription at the rate of \$15.00 annually; single issues (when available) \$1.50. Reduced rate for qualified students. Foreign subscriptions are on a paid basis only at a rate of \$25.00 annually. No subscription agency is authorized by us to solicit or take orders for subscriptions. Controlled circulation paid at Columbus, O. and Form 3579 to be sent to F. D. Thompson Publications Inc., P.O. Box 2000, Greenwich, Conn. 06830. Copyright 1970, F. D. Thompson Publications, Inc. Microfilm copies of DATAMATION may be obtained from University Microfilms, Inc., 313 No. First St., Ann Arbor, Michigan.

Printed by Beslow Associates, Inc.

This issue 105,912 copies

**DATAMATION**



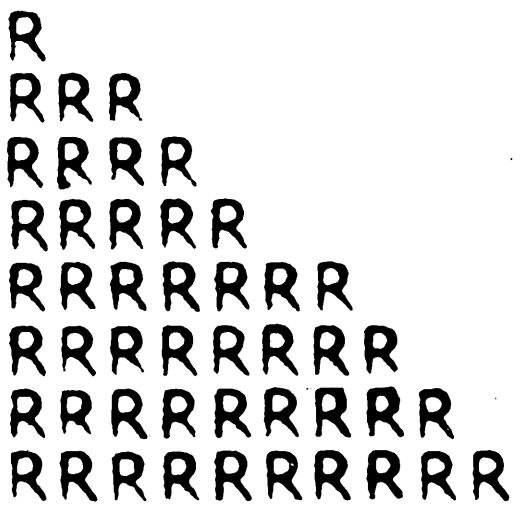
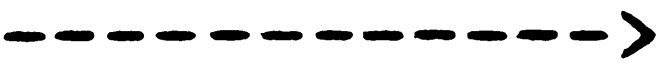

First choice. By far.

ADR's Autoflow system is now at work on a day-to-day basis in over 1000 installations around the world.

This means more computer systems in more diverse applications than any other comparable software system.

For one simple reason.

Autoflow is readily recognized as the most versatile, most productive system available for flowcharting, documentation and debugging.

Autoflow saves time, cuts non-productive chores. Delivers the flexibility and capabilities to give you greater efficiency and productivity from your equipment and people.

Autoflow accepts programs in COBOL, FORTRAN, PL/1 or Assembly languages. Available for IBM 360, H200, Spectra 70, IBM 1400 and 7090 systems.

Right now there are 1000 good reasons for you to write or call for information or a demonstration.

**Now over 1000 firms  
see  
the logic  
of  
Autoflow®**

Applied Data Research, Inc., Route 206 Center, Princeton, N.J. 08540.  
Tel: 609-921-8550, Offices in Atlanta, Boston, Chicago, Cincinnati, Cleveland, Dallas, Denver, Detroit, Hartford, Houston, Kansas City, Milwaukee, Minneapolis, New York, Philadelphia, Pittsburgh, Rochester, San Francisco, St. Louis, Washington, D.C. and principal foreign cities.



If you think DIGITAL'S PDP-10  
only means time-sharing,  
how come it probes the secrets of  
particle physics, simulates  
helicopters and soon will test the  
world's first supersonic transports?

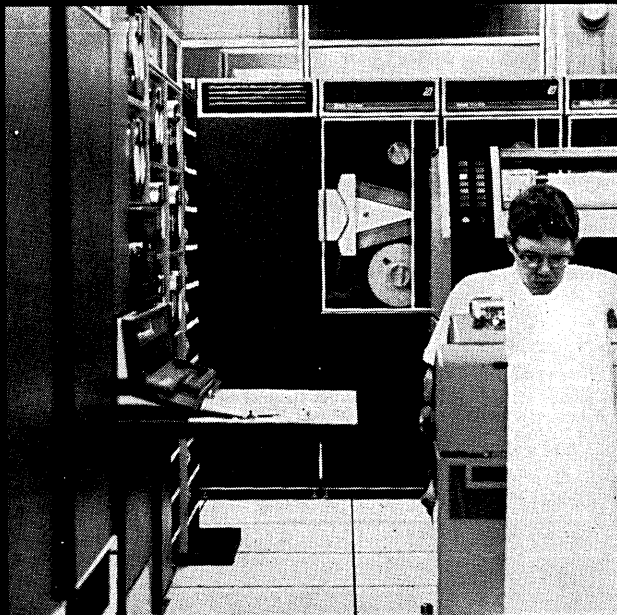

**PDP-10:**

Interactive time-sharing, batch processing, and real-time operations simultaneously. 3 levels of monitors. Re-entrant software. Seven user languages. On-line debugging. Modular expansion. All forms of bulk storage. Communications equipment. Real-time interfaces. Write for a brochure.

DIGITAL EQUIPMENT CORPORATION,  
Maynard, Massachusetts, Telephone:  
(617) 897-5111 / ALABAMA, Huntsville / CALIFORNIA, Anaheim, Los Angeles, and Palo Alto / COLORADO, Denver / CONNECTICUT, New Haven / DISTRICT OF COLUMBIA, Washington (College Park, Md.) / FLORIDA, Cocoa / GEORGIA, Atlanta / ILLINOIS,

Chicago / MASSACHUSETTS, Cambridge and Maynard / MICHIGAN, Ann Arbor / MINNESOTA, Minneapolis / MISSOURI, St. Louis / NEW JERSEY, Parsippany and Princeton / NEW MEXICO, Albuquerque / NEW YORK, Centereach (L.I.), New York City, and Rochester / NORTH CAROLINA, Chapel Hill / OHIO, Cleveland and Dayton / PENNSYLVANIA, Philadelphia and Pittsburgh / TENNESSEE, Knoxville / TEXAS, Dallas and Houston / UTAH, Salt Lake City / WASHINGTON, Seattle / AUSTRALIA, Brisbane, Melbourne, Perth, and Sydney / CANADA, Edmonton, Alberta; Carleton Place, Ottawa; Toronto, Ontario; and Montreal, Quebec / ENGLAND, London, Manchester, and Reading / FRANCE, Paris / GERMANY, Cologne and Munich / HOLLAND, The Hague / ITALY, Milan / JAPAN, Tokyo / SWEDEN, Stockholm / SWITZERLAND, Geneva

CIRCLE 20 ON READER CARD.

**digital**  
COMPUTERS • MODULES



# DATA MATION<sup>70</sup>®

february  
1970

volume 16

number 2

## datamation departments

Calendar	23
Letters to the Editor	41
Look Ahead	49
The Editor's Readout	59
News Briefs	164
New Products	197
New Software	219
New Literature	227
World Report	237
Washington Report	241
People	242
Poem	244
Index to Recruitment	
Advertisers	245
Books	255
Index to Advertisers	265
The Forum	273

- 60 AN OVERVIEW OF LIBRARY SYSTEMS AND AUTOMATION, by Barbara Evans Markuson.  
*What they do, how they do it, and where the computer can help.*
- 69 COMPUTER COSTS FOR LARGE LIBRARIES, by William N. Locke.  
*In some areas, the time is ripe for computer techniques; in others, they are out of the question.*
- 75 COMPUTER SUPPORT OF THE RESEARCHER'S OWN DOCUMENTATION, by Theodor B. Yerke.  
*The FAMULUS system allows the user to index his own literature collection according to his individual needs.*
- 79 BIBLIOS—A MODULAR SYSTEM FOR LIBRARY AUTOMATION, by John C. Kountz and Robert E. Norton.  
*A report on the Orange County Public Library system, serving 26 branches.*
- 87 A REGIONAL NETWORK—OHIO COLLEGE LIBRARY CENTER, by Frederick G. Kilgour.  
*This system will be able to catalog and process documents, keep track of their status, do retrieval, and facilitate serials control for member libraries throughout the state.*
- 91 LET THE COMPUTER SELECT YOUR READING LIST, by John R. Jordan.  
*The KWOC Index notifies each user of documents of interest, with the help of descriptors he has given on his user profile.*
- 98 SATCOM IN REVIEW, by Rowena W. Swanson.  
*An analysis of the latest government-initiated report setting guidelines for information exchange.*
- 106 A RATIONAL NUMBER CALCULATOR, by S. Berkowitz.  
*The search for a remainder.*
- 108 TRENDS IN MIS TECHNOLOGY, by Frederic G. Withington.  
*A forecast from each of the technological areas involved in MIS is given, and an optimum, yet possible, 1975 system is described.*
- 123 MINICOMPUTERS—FOR LARGE SCALE PROCESS CONTROL? by Ed Abrahamson.  
*A minicomputer system is described whose goals are decentralization and simplification.*
- 131 A SIMPLE-MINDED DOCUMENTATION SYSTEM, by Robert C. Maegerlein, Sr.  
*Internal documentation without pain.*
- 137 A MOST PROSAIC USE OF TIME-SHARING, by C. I. Keelan.  
*Johns-Manville brings the computer into the office, and saves lots of money.*
- 141 AMA UNRAVELS UNBUNDLING. A seminar report.
- 146 COMPUTER MANAGEMENT 69. A conference report.
- 155 INTERNATIONAL BUSINESS FORMS FORUM. A conference report.
- 158 NEWS SCENE  
*Users begin to react to unbundling, look closer at the IBM contracts, and come up with some advice . . . Professor Alan F. Westin pokes into the privacy issue at the Brookings seminars . . . General Electric and Penney's part companies with Tradar . . .*
- 192 SYSTEM SPOTLIGHT  
*An IBM 1800 at the U.S. Naval Observatory has been given the job of mapping the positions of over 10,000 stars.*

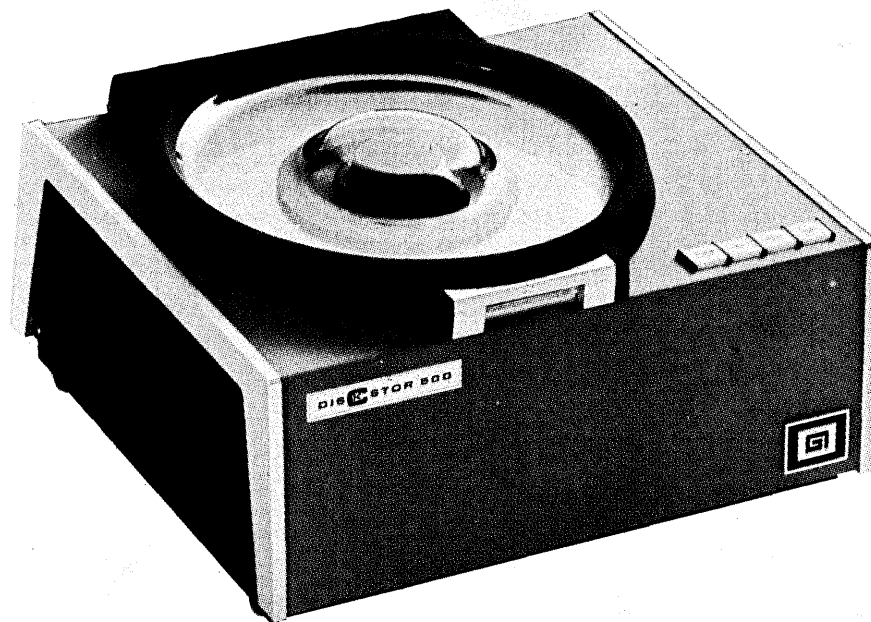

# DISCSTOR<sup>®</sup> 505 breaks through access time barrier! ( 8.7 milliseconds )

The new Systematics/Magne-Head **DISCSTOR 505** head-per-track disc pack memory system has an average access 10 times faster than the conventional disc pack memory. Storage capacity is up to 5 million bits on an operator removable pack. **Standard with DISCSTOR 505** are such features as: 8, 12, 16, and 18 bit data bus interfaces . . . unlimited memory expansion capability. **DISCSTOR 505** is an economical, fast access disc pack memory system designed for small and medium size central processing units.

*For complete information, call or write . . . or visit:*

**SYSTEMATICS/MAGNE-HEAD DIVISION**  
**GENERAL INSTRUMENT CORPORATION**  
13040 South Cerise Avenue, Hawthorne, California 90250  
(213) 679-3377/772-2351 TWX 910-325-6203



# GIVE THE LITTLE LADY A HAND!



One hand is all she'll need to operate the Mod 10 or the Mod 7. These tape systems were designed with the user in mind. So they're easy to use, easy to maintain, easy on the data processing budget. And they're elegant to look at, too.

Performance, high reliability and low cost are basic to both designs. Some of the new and better ideas are obvious: simple design, easier threading, fast and positive reel hold-down knobs. Other bonuses are built in: optimum IBM compatibility, off-line test functions, complete access for routine maintenance.

## SPECIAL NOTICE TO COMPUTER AND SYSTEMS MANUFACTURERS

The Mod 7 and 10 are easy for systems to use, too. They are plug-in compatible to most controllers for

low-cost tape handlers. Put a Mod 7 or Mod 10 in your computer, key tape, or other off-line systems. Then all the little ladies will be giving *you* a hand!

MINI-SPECIFICATIONS	Mod 7	Mod 10
Maximum Tape Speed	12.5 ips	37.5 ips
Reel size	7 in.	10½ in.
Formats	200, 556, 800 bpi, IBM, USASCII 7 or 9 tracks (1600 bpi phase encoding optional)	
Size	8¾ in. x 19 in.	19 in. x 24 in.

For more information about the Mod 7 and Mod 10, call or write:

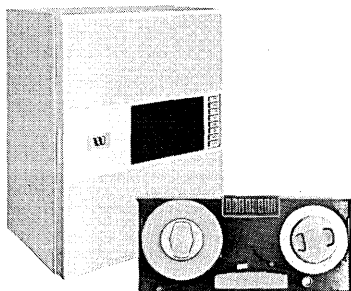

**WANG COMPUTER PRODUCTS, INC.**

2000 Stoner Avenue, Los Angeles, Calif. (90025) Telephone (213) 478-7727





*machines that make data move*



# data's wait-less wonder

**Hold tight. It's Teletype's Inktronic® terminal. A data terminal many times faster than the ordinary page printer. Zaps 1200 words to the page per minute. Electronically. It's another answer from Teletype R&D for moving data economically at high speed.**

\* \* \* \*

Off the ground and moving: Inktronic terminal. A space age terminal that doesn't tinker with time. And one time won't tinker with. Moves data on-line at 1200 wpm. And will have higher speed capabilities for tomorrow. Helps you get more in and out of the computer practically. And monitor high speed, tape-to-tape systems with new ease and economy. The line includes the KSR (keyboard send-receive) set shown here. And an RO (receive only) set. An ASR (automatic send-receive) set is coming.

## **Printing's unique space walk**

The Inktronic terminal is different. There's no type-box. Prints through electrostatic deflection. Ink literally leaps to the page to form a character. For ink droplets carry a negative charge and are drawn to the page through a series of electrodes that cause it to trace out the shape of the character called for. Each character is made up of a number of dots.

## **No waste space**

Inktronic terminal doesn't kill time or waste space on "fill" characters or buffer storage. It prints only the characters called for. Cleanly. And puts them on the line where you want them. You can print one character as readily as a few words or an entire line.

## **In orbit with ASCII**

Inktronic KSR will generate up to 128 code combinations and can print 63 alphanumeric. Take your

choice of an RO set with 5-level or ASCII code, or a KSR set with ASCII.

## **Keeps data tracking at less cost**

The Inktronic terminal uses ordinary teleprinter paper. Inexpensive paper. A standard 8½ inch wide roll provides about 400 feet of data space. The ink Inktronic terminals use is inexpensive, too. One pint will deliver up to 15 miles of data. With a 1200 wpm capability these are important points to consider. Maintenance? Really low. The ink supply and guidance system has only one moving part. And you get more data on and off line faster which means greater economy, too.

The Inktronic is one of many exciting moves being made by Teletype R&D in moving data at very little cost. If you would like more information, contact Teletype Corporation, Dept. 81B, 5555 Touhy Avenue, Skokie, Illinois 60076.



# forward error correction

- 4800 bps over dial-up lines
- totally automatic equalization

A combination of unique features?! Yes! The DATAMAX QB48 Modem gives you exclusive forward operating error correction that detects and corrects data transmission errors at the receiving end. Operating at 4800 bps, the QB48 continuously provides automatic equalization and interference free communications. And, the DATAMAX QB48 as with the rest of the DATAMAX Modem Family, can be used on dial-up or unconditioned private lines. At the price of ordinary modems, the DATAMAX QB48 will immediately increase your data traffic.

Join the DATAMAX drive for efficient data communications. Your QB48 Modems are available off the shelf.

Reverse your data costs now . . . call DATAMAX collect.

## DATAMAX CORPORATION

3941 Research Park Drive  
Ann Arbor, Michigan 48104  
313/769-0900

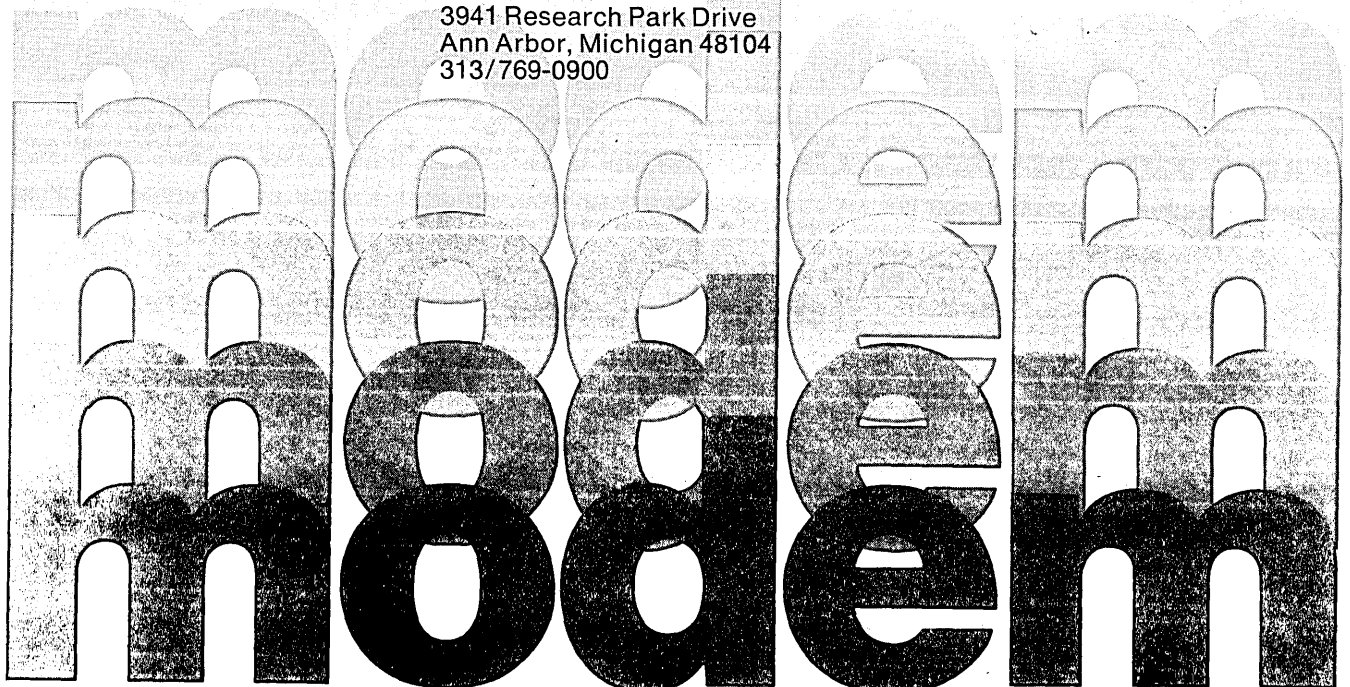



# Who else but Electronic Memories

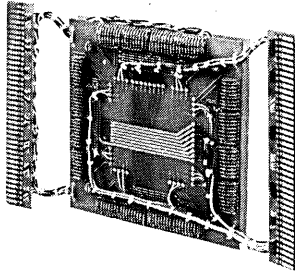

Rugged design for ground based mobile equipment, **NANOSTAK 020** commercial memory stack. High speed 850-nanosecond full cycle time for 4K memories. Features 3W, 3D organization with word capacities to 16K by 40. Built-in reliability and dependability. Available with wide temperature range cores for operation in severe environments.

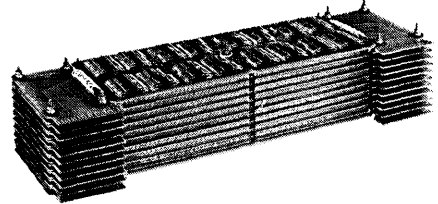

Perfect for high speed, large capacity mainframe memory systems... **NANOSTAK 3020**...technology breakthrough in 3W, 2-1/2D stacks. Stackable, compact size is an amazing 25% of competitive planar stacks and offers a significant advantage in form factor for system packaging. Extremely fast 650 nanosecond cycle time for 8K or 16K by 40, or 32K by 20 word memories.

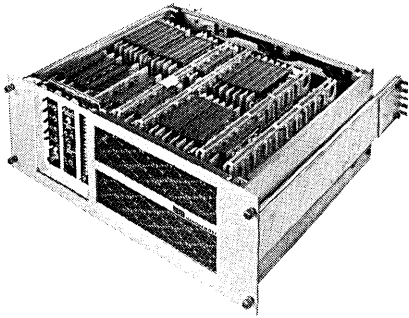

High speed commercial memory system — **NANOMEMORY 2600**. Full cycle time of 600 nanoseconds, and word capacities of 16K by 18 or 8K by 36. It's all done with a second-generation 2-1/2D drive system with efficient circuit and logic design, for reduced component count and high MTBF, and wide operating margins—the real feature of the 2-1/2D configuration. It is easily expandable in the field, and comes in a standard 19" rack.

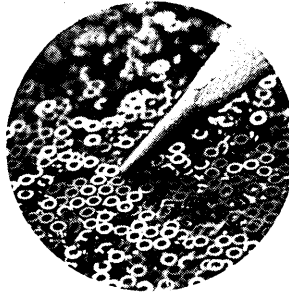

Five new memory cores for your next stack or system. All are medium or high drive, all coincident current, and all are fast switching for your high speed applications. Four new cores available in 18 mil, 20 mil, and two types of 30 mil sizes for use from 0° to 70°C. Also, a new wide temperature range 18 mil core for severe environments of -55° to +100°C.

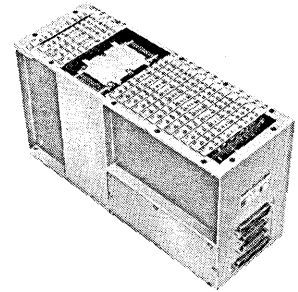

Compact, ATR compatible memory system **SEMS-6** for use in military and rugged commercial aircraft applications. Reliable performer is optimized around 8K or 16K with maximum capacities of 8K by 40 or 16K by 20. Full cycle time of 2 microseconds, with access time of 700 nanoseconds. Meets MIL-E-5400, low power consumption and lightweight.

# could introduce five brand spanking new memories—at once

Only Electronic Memories, the technology leader, could introduce five important new memories at once. Each one offers significant advances to provide you with faster, more reliable, and lower cost memories. Each one is loaded with outstanding new design features to give you faster access, larger capacity, and more economical operation. From cores and stacks to megabit memories, Electronic Memories has the memory products for your next, faster, more powerful computer system. For more facts and figures, just write.

**EM** **electronic memories**  
a division of electronic memories & magnetics corporation

12621 chadron avenue, hawthorne, california 90250  
telephone (213) 772-5201 TWX: 910-325-6213

# 7c off.



For a limited time only, PHI, creator and developer of computer software packages, is offering 7¢ off the purchase price of the PHI Generalized Payroll Package.

This offer is valid to any corporation listed in the Fortune 500, and to any company which would like to be listed there someday soon.

The PHI Payroll is the world's finest payroll package. It's the most efficient way for industrial corporations to process their own payroll, in-house, regardless of number of employees or diversification of operations.

Virtually any payroll problem can be solved by using the PHI Payroll Package (Maybe that's why 22 of the top 50 banks in the country use the Payroll to process customer's accounts, on a service bureau basis, as well as their own).

Make a note today to ask your corporate banker which payroll package he recommends. Chances are he'll recommend us. PHI. Clip the coupon, send it to us, and we'll get back to you fast.

Philip Hankins Incorporated  
(617) 648-8550

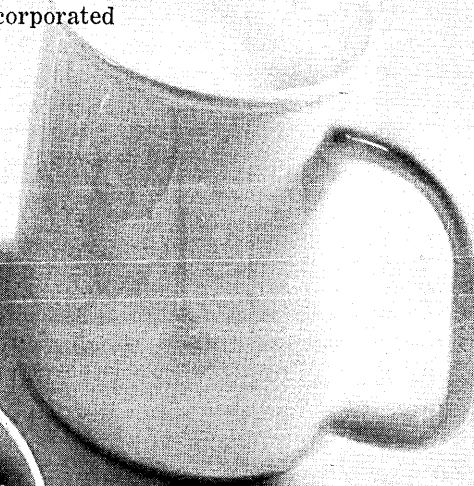

**7c** This coupon worth 7¢ toward the purchase of one (1) PHI Generalized Payroll Package. It is also redeemable for full cash value (7¢). Offer expires July 1, 1970. **7c**

Gentlemen:

- Send me the 7¢ cash, and more information about the Payroll.
- Send me more information, and give my 7¢ to charity.
- Send me the 7¢, and send the information to my favorite charity.
- Deduct the 7¢ from the purchase price of the Payroll System, and bill me for \$19,999.93.

Name \_\_\_\_\_ Title \_\_\_\_\_

Company \_\_\_\_\_

Address \_\_\_\_\_

City \_\_\_\_\_ State \_\_\_\_\_ Zip \_\_\_\_\_

**7c** Mail to: PHI, 800 Mass. Ave., Arlington, Mass. 02174 **7c**

CIRCLE 163 ON READER CARD

## Bendix reinvents the digitizer.

One moving part.  
The free-moving cursor  
arms and gears. So there's

nothing to slow you down. Our all-electronic Datagrid<sup>®</sup> Digitizer traces up to 300"/sec. With 0.001 resolution. On tracing areas up to 60" x 60". It's like nothing else you've ever used. Write: Bendix, Advanced Products Division, Southfield, Michigan 48075. Or Phone Mr. Dennis-at (313) 352-7661.



You're looking at it.  
that replaces all those  
nothing to wear out. And







## CalComp even makes software for the softwear makers.

CalComp makes terrific plotters, all right.

But it's really our *software* that makes our plotters the greatest.

You see, nobody else offers you what we do. Over 3,000 programs of basic and functional software. Plus applications.

Like our new automatic pattern grading for apparel makers. (Which figured out these paper patterns for different-size bikinis.)

Like our general contouring program. For precise maps of oil fields, oceans, weather and stars.

Like a business program that generates financial graphs. Another that puts out PERT schedules. Another for CPM schedules. And still another that plots the flowchart of any other computer program.

Like a subdivision mapping program that rapidly plots lots of lot plots.

Like a 3-D program that can actually draw three dimensional surfaces from any angle. And in any perspective. Even in stereo.

And the best part is, CalComp *software* is ready and available for all kinds of CalComp *plotters*. Including our basic CalComp drum plotters, giant CalComp flatbed plotters and even speedy CalComp microfilm plotters.

In fact, CalComp is the leader in computer graphics. With sales, service and software support in 34 cities around the world.

So if you need help

with some kind of graphics problem, call your nearest CalComp man today.

You never had it so soft.

**CALCOMP**

TEACH YOUR COMPUTER TO DRAW.

California Computer Products, Inc  
Dept. D-2, 305 N. Muller Street,  
Anaheim, California 92803

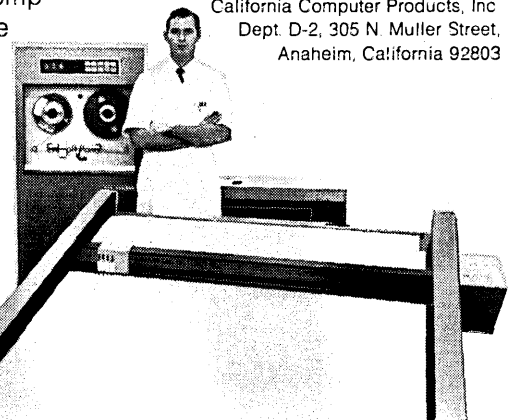

# Make binding decisions without asking the computer.

You've got to make a decision.  
What kind of data binders are  
best suited for your tab sheets.

Size. Fastening devices. Cover  
material. Price. All are important  
any way you look at it.

We'd like you to look at it  
through our 16-page, 4-color  
Accodata binder catalog.  
All binders, Accohide®\* and  
Pressboard are completely  
cross-indexed.

All accessories, colors, uses,  
are all fully described. All to  
make your binding decisions  
a little easier.

All you have to do is write  
for your free Accodata  
catalog today!

\*a chemical resin.



5150 N. Northwest Highway,  
Chicago, Illinois 60630;  
New York, Los Angeles,  
Boston; Gary International,  
Chicago-U.S./Canada/  
England/Holland/Mexico  
Venezuela/Japan/Divisions  
of Gary Industries, Inc.

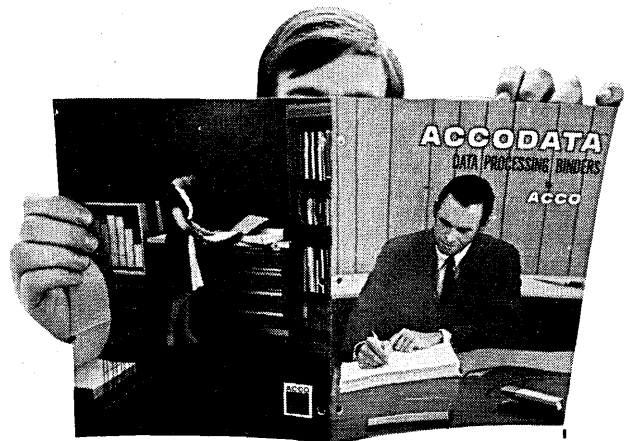

Please send my Free  
Accodata Binder Catalog.

Name

Title

Company Name

Address

City

State

Zip

Acco, Dept. D2  
5150 N. Northwest Highway  
Chicago, Illinois 60630



## IS HIS MINI COMPUTER ALL THAT GOOD? OR IS IT HIS SALESMANSHIP?

Every knock on the door these days is another mini computer salesman.

Most of the companies you can rule out without even talking with them. But there are three or four of us you really have to talk to.

And four is a lot of mini computer pitches to have to evaluate.

So this is what Data General's going to do.

We're going to send you not just another mini computer salesman. Not just another guy with a shoeshine and a smile who knows only enough about mini computers to tell you just what his company told him to tell you.

We're going to send you a Data General applications engineer who probably knows a lot more about mini computers than anyone in your company. A man who has specific instructions from us to tell you to forget about Data General if our computers aren't right for you.

We'll also tell you enough about our two mini computers right now so you'll know whether we're in your ballpark or not on the basis of this ad alone.

Both our Nova and Supernova have multi-accumulator organizations, 16-bit word length and a simple package design. They're 5¼" high. Their read-only memories are interchangeable with their core memories.

Nova in a basic 4K configuration with Teletype interface goes for \$7950.

Supernova has an add time of 800 nanoseconds from core memory, 300 nanoseconds from read-only. In its basic 4K configuration, Supernova goes for \$11,700.

If neither of these Data General mini computers sounds like what you're looking for, so long.

It's been nice talking to you.

# DATA GENERAL

Makers of Nova and Supernova mini computers.

# Tape could be the medium for your message.

It all depends on the data. That's why the Daedalus 711 Programmable Data Terminal lets you communicate in the most economical way possible.

Mag tape cassettes. Hard Copy. On-line and off-line via Ma Bell.

These are the ways you can get your message across to any central processor with the Daedalus 711 Programmable Data Terminal. Pick the medium you want when you want it.

Which makes sense and makes profit. Because our 711 PDT is programmable you can set-up, update and change programs via mag tape or direct transmission.

And you can batch data and transmit it a la cassette and Ma Bell during off-hours. Or, if the data is not timely enough for direct interchange, you could put it on tape and put it in the mail. Another medium? Hard copy documentation, on preprinted forms, of data transmitted and received makes our terminal with full arithmetic and logic capabilities all the more logical for

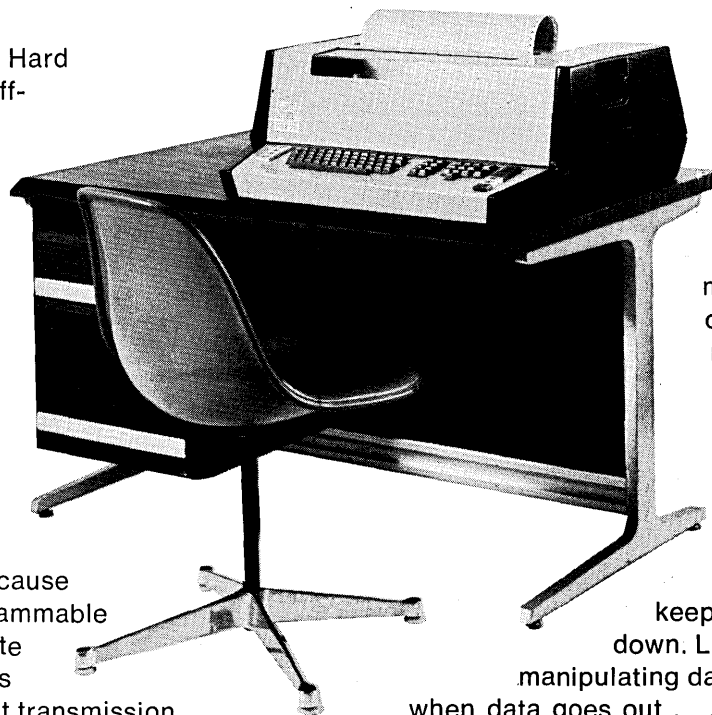

your application. And this is all due to the fact that the Daedalus 711 Programmable Data Terminal is the one and only truly programmable data terminal, with over 45 instructions in its repertoire, an under-11K pricetag, and the ability to do whatever you want to do in a frugal manner.

Like changing programs from a central location to keep programming expenses down. Like editing, verifying and manipulating data at the terminal site so when data goes out . . . it stays out. Like interchanging data independently and unmanned off-hours to be even more economical.

Like . . . well, you get the message. And you might like to get more information from: Daedalus Computer Products, Inc., P. O. Box 248, North Syracuse, New York 13212. (315) 699-2631.

*Daedalus. The new company making computer history happen overnight. Every night.*





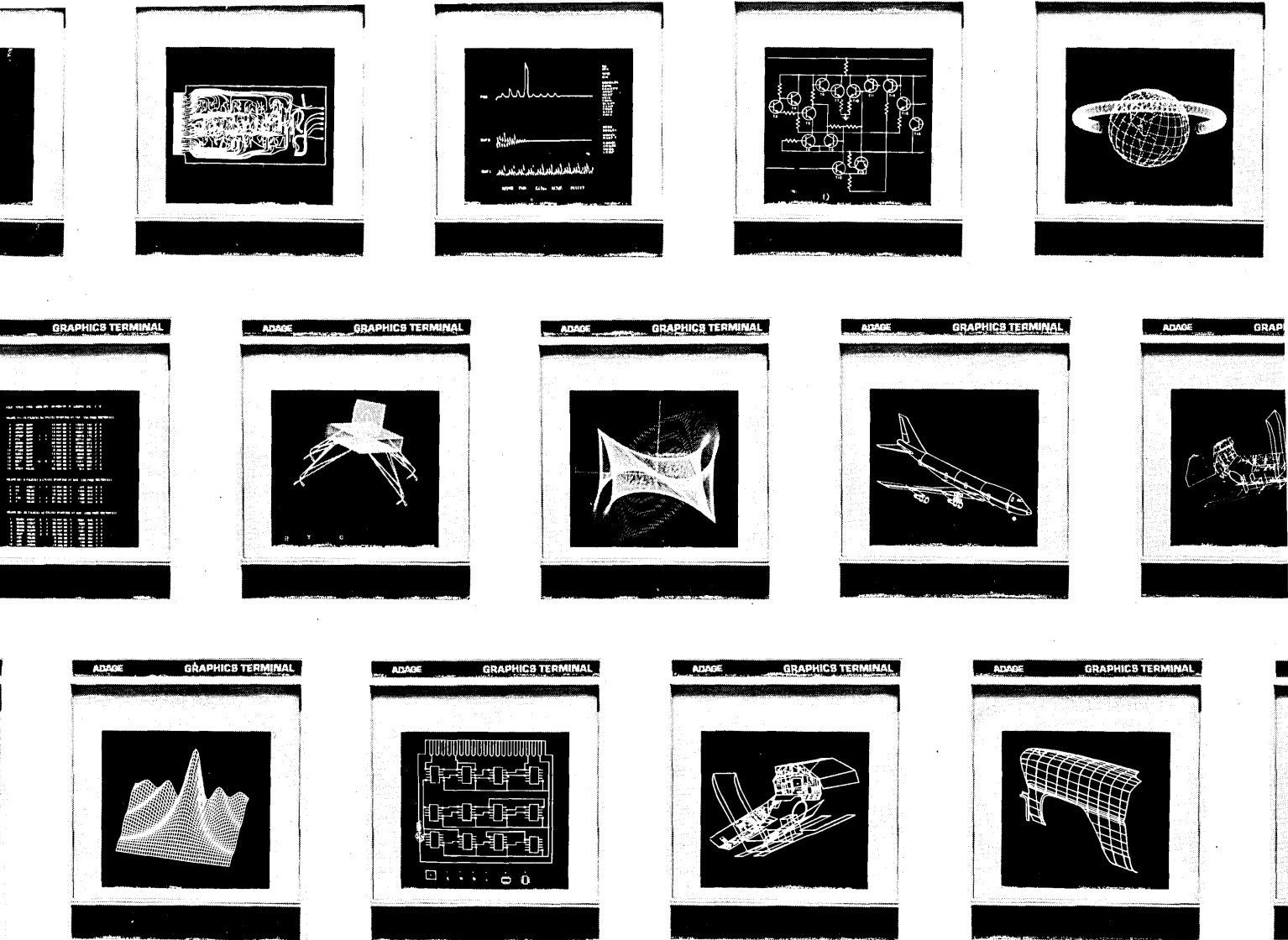

## Looking for interactive graphics? Shop Adage first.

We're not an interactive graphics supermarket, but we're beginning to look like one. That's because we are the only company marketing a full line of standard off-the-shelf graphics terminals covering a broad range of price and performance.

Because of our experience in many fields, we can provide you with the best and quickest solution for your specific application. Adage Graphics Terminals are now in operation in government facilities, the oil industry, processing and manufacturing plants, aerospace, and in university research laboratories. Applications range from three-dimensional dynamic simulations to information retrieval and decision making. And from automating PC-board production to supporting engineering design of new aircraft. Our terminals are being used for computer-aided signal analysis, for geophysical data reduction, and for geological contouring.

Maybe we are an interactive graphics supermarket!

When you consider its features, it's easy to see the reasons for the wide-spread use and acceptance of the Adage Graphics Terminal. The AGT is a general-purpose CRT display system designed especially for interactive graphics applications. It has a digital display processor, display generation hardware, and a large screen CRT console with a full set of operator controls. An AGT has extensive built-in image manipulation capability, it normally includes magnetic tape or disk storage, and it's always supplied with comprehensive systems software. These result in a terminal with a high degree of autonomy: an AGT can

be connected to a central computer system without burdening the response time or arithmetic capabilities of the central system, or it can be used in a stand-alone mode.

Model AGT /10 is designed for efficient handling of two-dimensional displays. Images can be continuously expanded or reduced or moved about on the screen. The AGT /30 is configured to optimize its use in applications involving dynamic display of three-dimensional images, i.e., such images can be rotated, translated, and scaled with picture changes made from frame to frame. The AGT /50 is our super-powered model with a variety of extra display modes. It can generate very complex dynamic pictures containing up to 8,000 line segments. AGT's start at \$60,000.

One very nice feature – any model can be upgraded in the field. So, if your problem expands, so does your terminal.

If you're in the market for interactive graphics, shop our supermarket first. Write to our Super Market Manager, Adage, Inc., 1079 Commonwealth Avenue, Boston, Massachusetts 02215, (617) 783-1100.

**adage**  
Computer  
Graphics

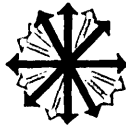

# calendar

DATE	TITLE	LOCATION	SPONSOR/CONTACT
Feb. 23-25	Annual EDP Conference	New York City	AMA 135 W. 50th St., New York, N.Y. 10020
Feb. 23-25	3rd Annual DP Conference	Ottawa, Canada	DP Inst./Revett Eldred 360 Lisgar St., Ottawa 4, Ont., Canada
Feb. 23-25	Winter General Meeting	New Orleans	DPSA P.O. Box 1333, Stamford, Conn. 06904
March 9-12	Spring Conference	Washington, D.C.	EIA 2001 Eye St. N.W., Washington, D.C. 20006
March 23-25	Computer Science in Life Sciences Symposium	Houston	Univ. of Texas, CED P.O. Box 20367, Houston, Tex. 77025
March 23-25	Process Measurement & Control Symposium	New Brunswick, N. J.	ISA/D. Borut M. W. Kellogg Co. 711 Third Ave., New York, N.Y. 10017
March 23-25	Info-Expo-70	Washington, D.C.	Info. Indus. Assoc. 1025 15th St. N.W. Washington, D.C. 20005
March 23-26	Int'l Convention & Exhibition	New York City	IEEE 345 E. 47th St., New York, N.Y. 10017
April 8-10	Numerical Control Conference	Boston	NCS/Lawrence Levine Hitchiner Mfg. Co., Inc. Milford, N.H. 03055
April 10-19	Electronics Fair	Tokyo, Japan	Int'l Commerce Bur./ U.S. Commerce Dept. Washington, D.C. 20230
April 14-16	Computer Graphics Int'l Symposium	Uxbridge, England	Brunel Univ./R. D. Parslow Computer Sci. Dept. Uxbridge, Middlesex, Eng.
April 28- May 1	Nat'l Microfilm Convention	San Francisco	NMA .250 Prince George St., Annapolis, Md. 21404
April 29-30	15th Annual DP Conference	Birmingham, Ala.	Univ. of Alabama Anyan Gordon, CES, P.O. Box 2987, University, Ala. 35486
May 5-7	Spring Joint Computer Conference	Atlantic City	AFIPS 210 Summit Ave., Montvale, N.J. 07645
May 11-16	Instruments, Electronics, Automation Int'l Fair	London, England	U.S. Commerce Dept. BIC/CEP, Room 6813, Washington, D.C.

## Why risk the loss of valuable input data when power fails?

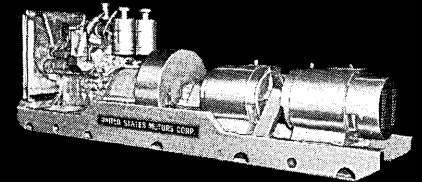

No-break units available from 3 KW up to this 300 KW size.

### Install Micro Power TP .....the total protection system

Micro Power gives you total protection — uninterruptible power which guarantees precise frequency and voltage control during any power interruption or failure.

#### What it is

Micro Power consists of an electric motor, generator, flywheel, engine, and control system.

#### How it works

The motor-generator-flywheel is run constantly to level out frequency and voltage variations in the main power source. When a power interruption occurs, the flywheel inertia maintains the frequency and voltage output; the engine starts immediately and comes up to synchronous speed and engages the motor-generator-flywheel combination providing good quality power output as long as the power interruption lasts.

#### Why Micro Power is BEST

Micro Power provides Total Protection against transient variations in frequency or voltage plus emergency protection against short or long term power failures. It provides positive, total protection rather than partial or short term protection as supplied by line volume stabilizers, inverters, or battery systems.

Where costly equipment is operated around the clock, down time costs can quickly exceed the investment required for a Micro Power TP System. That is why there are more than 6000 TP systems in use throughout the world. Obtain full details from our Micro Power TP specialists. 3 NB

**USM UNITED STATES**  
MOTORS CORPORATION  
EST. 1890 351 WEST 20th AVENUE  
OSHKOSH, WISCONSIN 54901  
(414) 231-4560

Henry "Speed" Register III of  
National Computing Industries comments,

## "WORK TEN is as fast as greased lightning"

"That's because it does all the mechanical work for you. Automatically.

"You don't have to worry about detailed definitions of files and records. You don't have to bother with the mechanics of manipulating printers. You don't worry about the size of print lines, editing, carriage control characters, page breaks.

"You don't manipulate the details. You don't concern yourself with determination of record types, end of file conditions, matching of files together, nor the mechanics of constructing and inserting new records in files.

"You don't even bother with rolling and clearing total levels, nor the determination of control breaks. You don't pay any attention to syntax, missing periods, commas in the wrong place, nor any of dozens of other miserable little details.

"WORK TEN handles all these things perfectly and automatically every time, as it generates COBOL programs, generates standard documentation and prints cross-reference listings to every program affected by every change you choose to make.

"Check into WORK TEN today."

# NCI

NATIONAL COMPUTING INDUSTRIES  
3003 NORTH CENTRAL AVENUE  
PHOENIX, ARIZONA 85012  
TELEPHONE 602: 264-1394

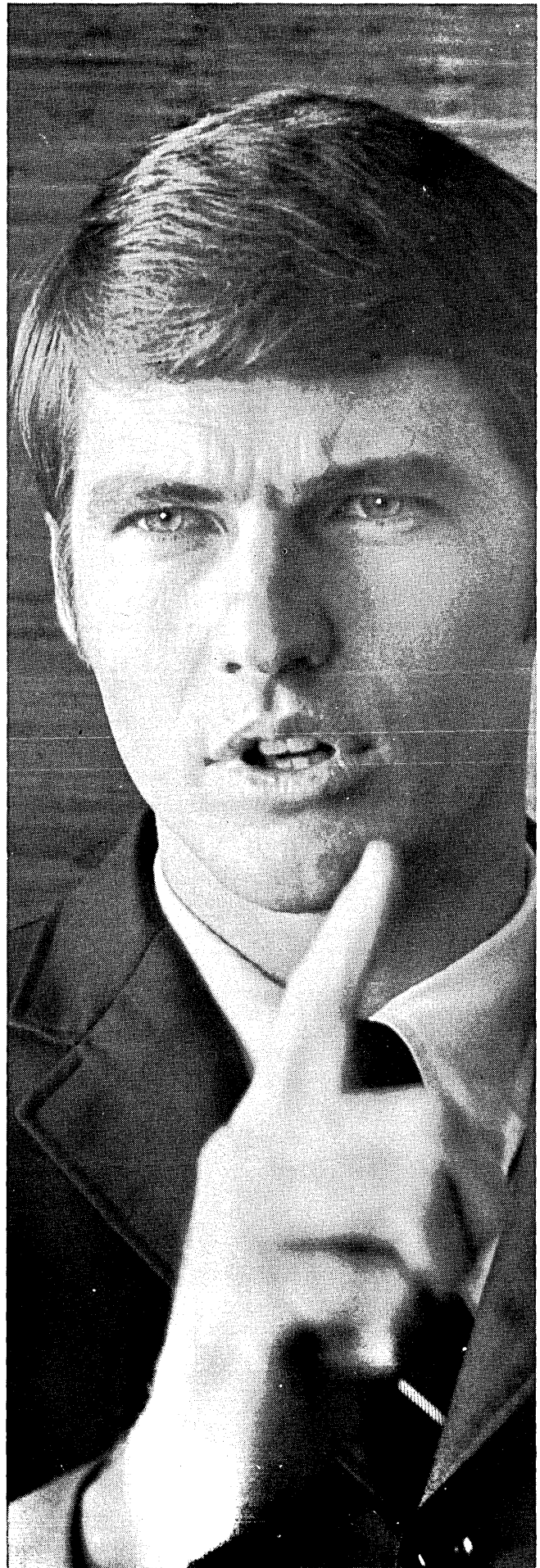

We can make you a winner. All you have to do is run with our new plated-wire stacks.

They'll give your 3rd- and 4th-generation mainframe memories blazing speed: Nondestructive read cycle time, 150 nanoseconds or less. Write cycle time, 300 nanoseconds or less.

And how about vendor reliability and assured delivery dates? You get them because of our revolutionary

packaging techniques. We make the unique tunnel structure, with its integral word straps, entirely in-house.

You save space, too. Typical one-plane stack is 12 $\frac{1}{2}$ " by 15 $\frac{1}{2}$ " by  $\frac{1}{2}$ " thick, packing 72K bits for any standard word/bit configuration. For economy's sake, the organization is compatible with the 2 $\frac{1}{2}$ D techniques of present submicrosecond core memories.

So team up with Lockheed's plated-wire stacks — you'll have the world's fastest mainframe memory running for you. Write to Memory Products, Lockheed Electronics Company, Data Products Division, 6201 East Randolph Street, Los Angeles, California 90022.

**Lockheed  
Electronics**

A Division of Lockheed Aircraft Corporation

## Break records with your next mainframe memory.

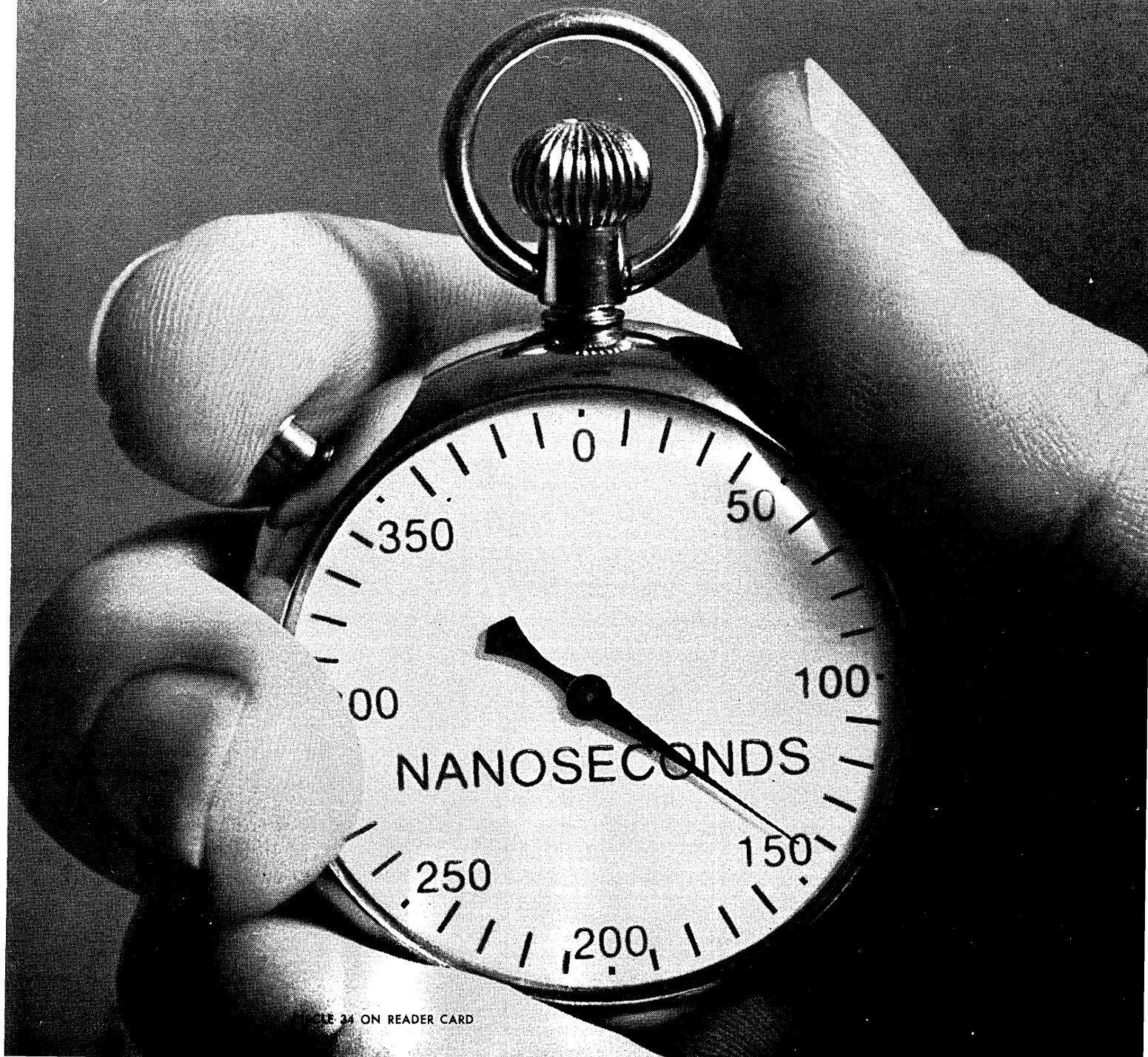







# New housing development.

It's the new National Data Reference Control System, the simplest, most complete record-keeping system ever designed for computer printouts!

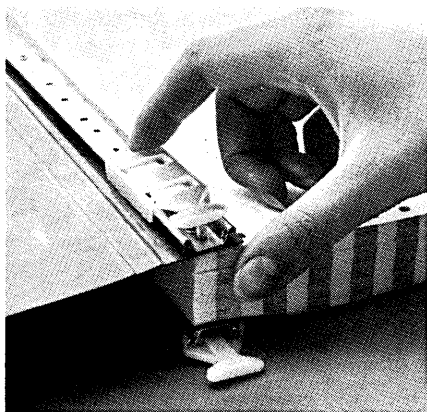

Here, for the first time, is a *total housing system* of data binders and compatible hanging devices and accessories fully integrated with a complete selection of floor and desk-top referral and retention units. No more improvised binding or hanging methods, no more make-shift storage arrangements.

The heart of the new system is National's exclusive Hang-A-Ref™ Binder designed to simplify the binding and hanging of burst and unburst printouts. A unique sliding hook extends to hold the binder in suspension or slides back into the binder

for easy carrying and reference. A secondary connector unit called Slide-A-Ref™ is used in tandem with the versatile binder to provide easy hanging and to permit users to slide bound printouts in and out of desk or floor storage stations.

The National Control Rack 900™ Series of attractive, sturdy floor and



desk-top storage units is engineered to provide maximum flexibility in setting up modular control stations to meet every record-keeping requirement. The series includes both skeletal and fully enclosed locking units as well as a sturdy connecting unit called Connect-A-Ref™ which enables users to link various combinations of floor racks.



Get the complete facts now. Ask your National representative or mail the coupon for free color brochure.

National Blank Book Company, Inc.  
 Department D- 2  
 Holyoke, Massachusetts 01040  
 Please send me a free copy of your new Data Reference Control System brochure.

Name \_\_\_\_\_  
 Title \_\_\_\_\_  
 Company \_\_\_\_\_  
 Street \_\_\_\_\_  
 City \_\_\_\_\_ State \_\_\_\_\_ Zip \_\_\_\_\_



**NATIONAL BLANK BOOK COMPANY, INC.**  
 A Subsidiary of Dennison Manufacturing Company



# the computer industry's first key-to-disc

## data input system

**accepts the output from 60 or more  
key stations simultaneously**

**Time-shared input cuts data preparation costs 50%.**

Now you can cut your computer input costs in half. This new innovation in data preparation techniques gives you two money-saving advantages over conventional keypunch or one-keyboard/one-magnetic-tape-per-operator systems: (1) the LC-720 employs a computer time-shared input; (2) it is the only system available that provides data output directly on IBM/360-compatible magnetic disc.

By time-sharing the data from 60 or more keyboard operators simultaneously, significant savings in data station costs of as much as 50% can be achieved. Costs drop to as low as \$4300 per data station for a typical 60 station system. For large data preparation installations, the time-shared input is the only economical way to go.

Data entered into the LC-720 is processed by a small digital computer and stored on an IBM/

360-compatible magnetic disc that provides the advantages of bulk storage and high speed random access of data. The problems associated with punched card handling or the mounting, pooling, merging and unmounting of magnetic tape reels are eliminated. All data is conveniently and economically stored in an IBM 1316 disc pack for direct high speed input to your modern data processing system. Naturally, an IBM/360-compatible magnetic tape is also provided with the system as standard equipment.

The LC-720 KeyDisc System also offers for the first time, data verification requiring one input pass only through the system, in addition to the normal technique of verification requiring two different operators. Record size is infinitely variable by each operator from 1 to 120 characters long and the system stores a large library of 30 or more different format control programs, all available simultaneously to any and all operators.



### **LC-720 KeyDisc System**

**Bring your own data for a demonstration**

Logic Corporation invites you to see an operating demonstration of the LC-720 KeyDisc System at the company's premises. Bring your own original data and Logic will provide a reel of magnetic tape of the output of your data from the LC-720 for later printout at your own computer facility.

**To arrange for a demonstration, contact Gary Tischler, Director of Marketing (201) 334-3713**

**LOGIC  
CORPORATION**

15 E. Euclid Ave., Haddonfield, N.J. 08033 (609) 428-4626



# Attention mini computers.

No mini computer has ever enjoyed choosing a printer.

Mainly because there have never been any appropriate printers to choose *from*.

On the one hand, there were little typewriter-type printers that were much too slow for high-speed mini computers.

And on the other hand, there were big superspeed printers that were designed for big superspeed computers. And they were much too expensive for mini computers.

Those were the choices.

And if the mini computer didn't like it, it was "Sorry, pal, take it or leave it."

Not much fun.

So if you're a mini computer, you'll be glad to know there is now a printer that was designed specifically for you.

It's not too slow. It's not too expensive. It's exactly right.

So rejoice, mini computers.

Rejoice.

## Nortec's mini line printer.



CIRCLE 157 ON READER CARD

Nortec 200 is 132 columns, prints at 200 lines per minute, produces crisp type on up to 6 copies. The entire unit, with all electronics including buffer controller, ready for direct hookup to computer, is as little as \$6000 in OEM quantities. It's just a little larger than an electric typewriter. The \$6000 price includes these standard features: IBM-compatible vertical format unit, front-opening yoke assembly for easier forms loading and ribbon changing, self-test feature for testing electronics and mechanism. Nortec Computer Devices Inc., a Computer + Technical Company, Ashland, Mass. 01721, (617) 881-3160.







# Here's another good reason our time-share system is the most popular around: 90-day delivery!

You don't have to play the waiting game when you order our HP 2000A Time-Share System. It's ready for you almost as soon as you're ready for it. In most cases, you can take delivery 90 days after we get your order.

But getting customers on the air fast is just one reason for our system's success. There are plenty of others.

Like price. Our system costs only \$90,500. Yet it handles 16 remote terminals simultaneously. This alone gives it one of the lowest costs per terminal-hour in the industry. And the modest initial investment is matched by the 2000A's remarkably low operating cost. Overall, it's the most economical time-sharing system going.

Simplicity is another reason for our system's popularity. HP BASIC is the easiest computer language around. That's why it's a favorite with scientists, engineers, educators, businessmen and other non-programmers. They can learn it in just a couple of hours, because it's almost like talking to the computer in English. Yet because the HP 2000A is so powerful, these users can put it to work on such sophisticated operations as matrixes, strings, and files.

The HP 2000A comes ready for your immediate use. All required software, control terminal and interfaces are included. And this system keeps on working and working and working. In fact, our customers have already logged over four million terminal-hours of successful, trouble-free operation.

With this kind of money-saving reliability, it's no wonder our time-sharing system is the most popular one around.

Need further proof? Call your local HP computer specialist. Or write to Hewlett-Packard, Palo Alto, California 94304; Europe: 1217 Meyrin-Geneva, Switzerland.

HEWLETT  PACKARD

DIGITAL COMPUTERS

CIRCLE 64 ON READER CARD

22934



# \$10,000 REWARD!

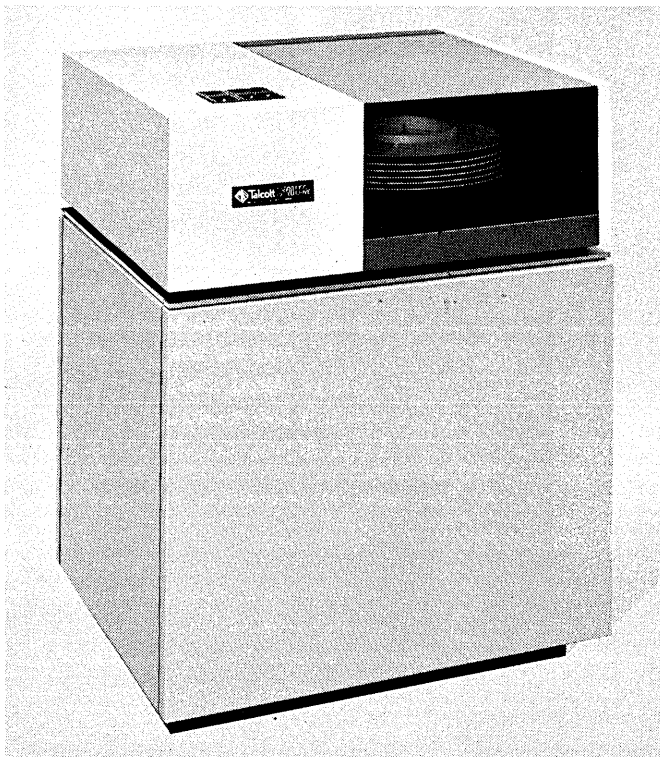

When you consider the fact that there are no premium charges for extra shift work on the Talcott 9311 Disc Drive, you can quickly calculate even greater savings than this on just a three-year lease. But that's just for one unit. In actual use, you can connect up to eight 9311's to one 2841 Control Unit. They can even be intermixed or directly interchanged with the 2311 or similar disc unit. Complete plug-to-plug compatibility. The Singer Company, Friden Division has engineered the 9311 to give greater reliability—with a unique servomechanism instead of a

hydraulic system. Now consider this: dependable service by the worldwide Friden Customer Service Organization; leasing arrangements to give you maximum savings by Talcott Computer Leasing. Ready to "unbundle" your 2311's? Contact your local Friden office or write: Friden Division, The Singer Company, San Leandro, Calif. 94577.



## Talcott

**TALCOTT COMPUTER LEASING**

Division of James Talcott, Inc.

1290 Avenue of the Americas, New York, N. Y. 10019

# Increase the ins and outs of your mini-computer with a Sykes Direct Access **COMPU/CORDER™ System\*** for less than \$3,000.

The Sykes COMPU/CORDER is a high speed, direct access, magnetic tape transport system that behaves like a disc. It represents a new and unique generation of cassette-loaded direct access devices.

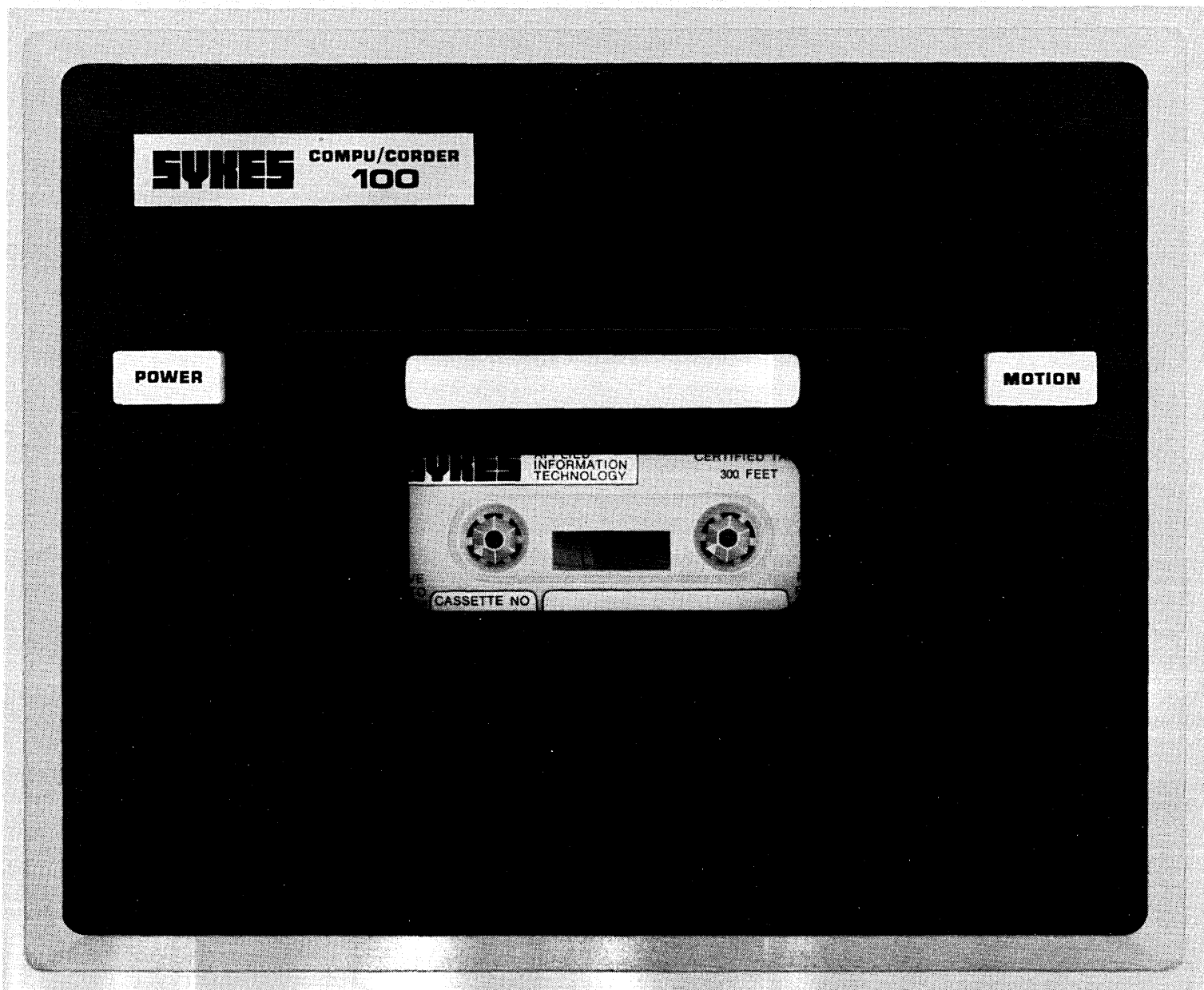

# Why is the COMPU/CORDER System Unique?

The system is completely reliable. Its high-speed, direct access and bi-directional capabilities, together with its modern engineering design, complement any mini-computer installation.

Other major features include:

- Bi-Directional access up to 120 inches/second.
- Average direct access time within 100 feet—5 seconds.
- Exclusive tape addressing system.
- Specialized cassette.
- Dual I/O Buffer.
- Software is comprehensive and ready to use.
- Block length truly variable. Limited only by tape length.
- Interfaces available.
- System capacity of up to 8 COMPU/CORDERS
- System data storage 28,800,000 bits.
- Simultaneous Read/Write, Read/Read, Write/Write.
- Initial installation and instruction provided.
- 90 day warranty.
- National customer field service

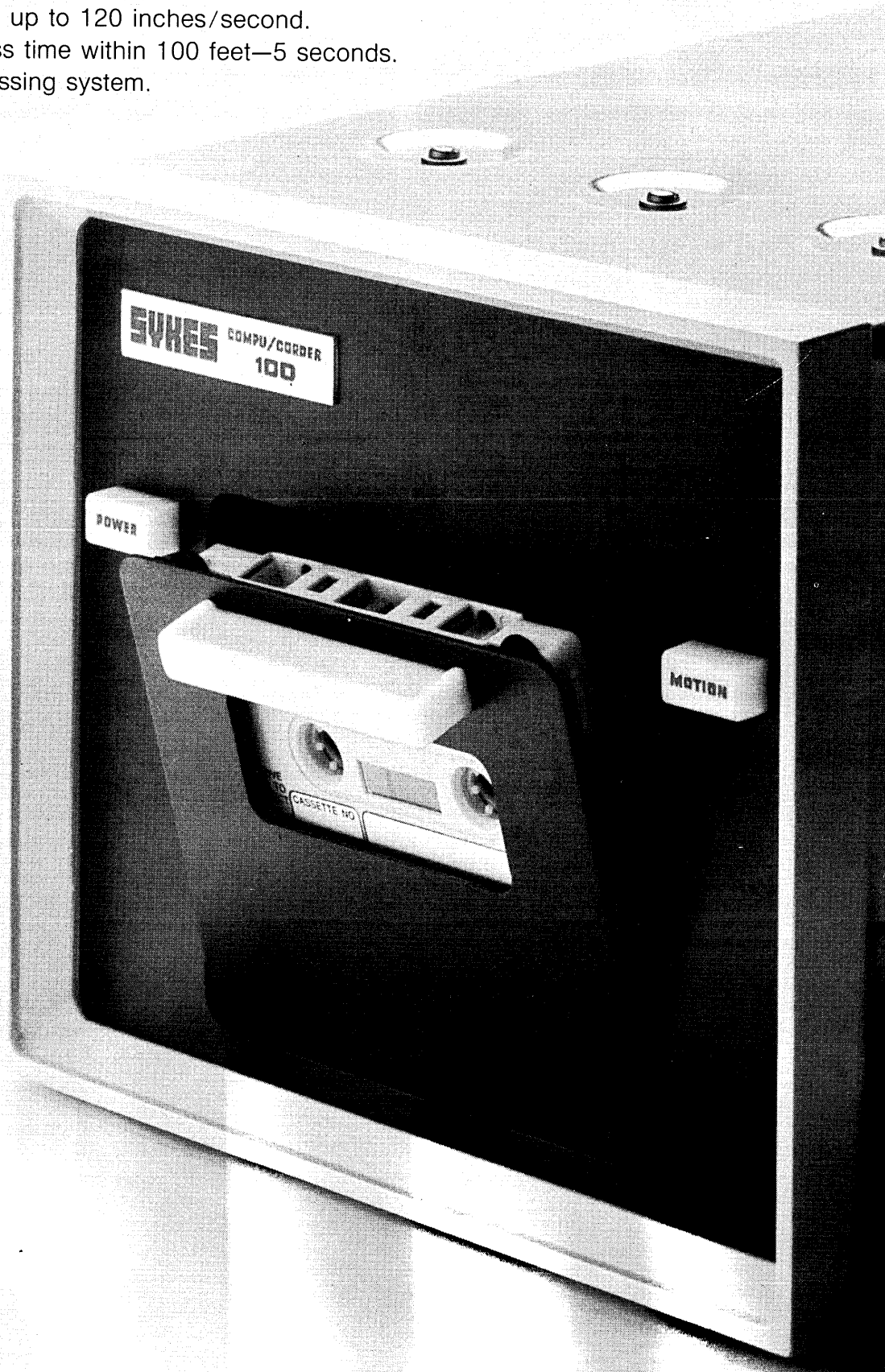

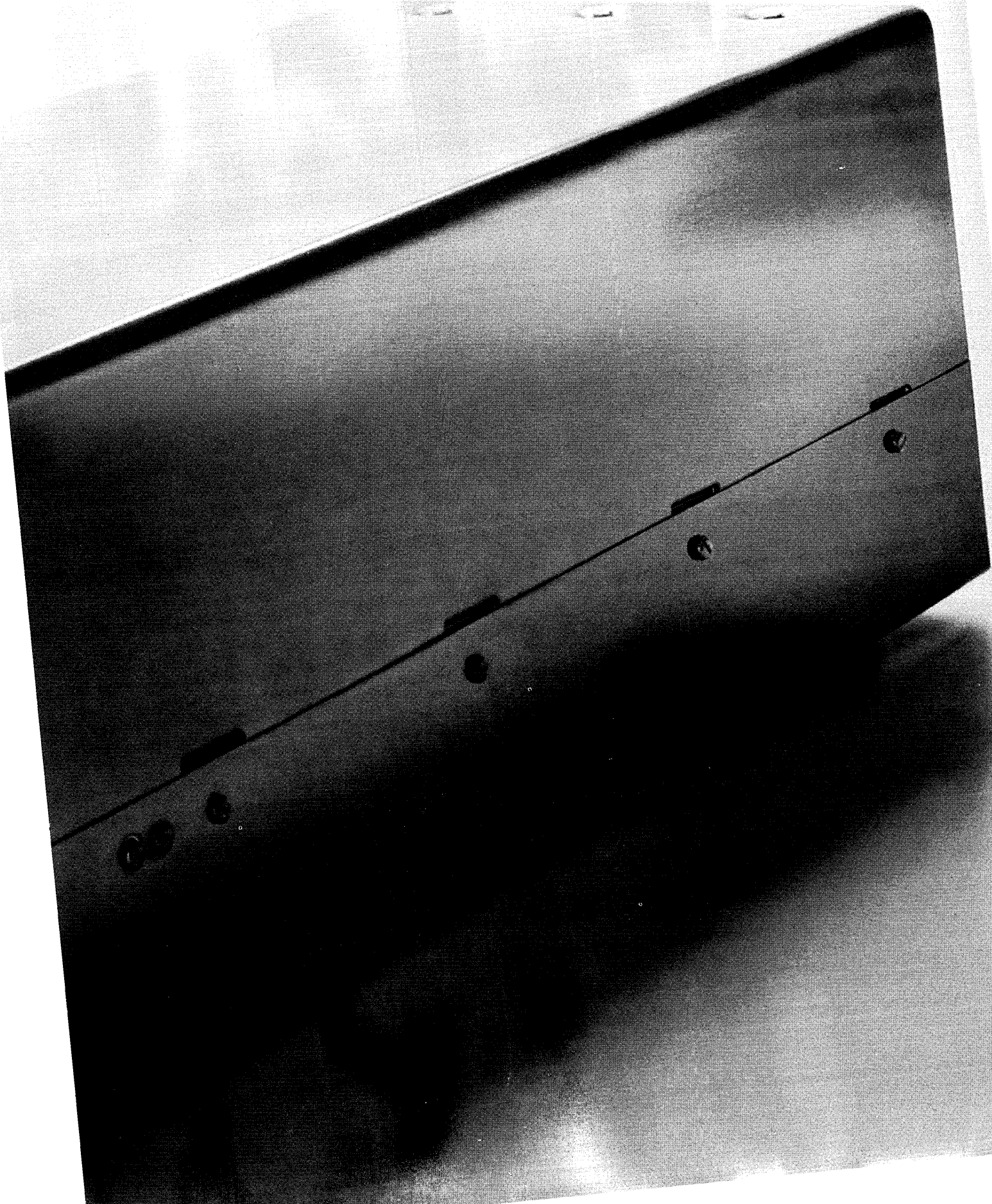

We think you'll want to know more about **COMPU/CORDER**. Just fill out the coupon and one of our representatives will be in touch.

**SYKES**

APPLIED  
INFORMATION  
TECHNOLOGY

SYKES DATATRONICS INC. TM  
ROCHESTER, NEW YORK 14606

**Sykes Datatronics, Inc. • 375 Orchard Street, Rochester, N.Y. 14606 • (716) 458-8000, ext. 12**

Tell me more about **COMPU/CORDER**.

Name \_\_\_\_\_ Title \_\_\_\_\_  
Company \_\_\_\_\_  
Address \_\_\_\_\_  
City \_\_\_\_\_ State \_\_\_\_\_ Zip \_\_\_\_\_

Have a Sykes representative call  
 Send detailed literature





# HANG IT ALL!

THE 500 LARGEST INDUSTRIALS AS REPORTED IN THE OC

RANK	COMPANY	SALES	NET INCOME
			\$000
1	1 GENERAL MOTORS	20,208,505	179,3
2	2 FORD MOTOR	12,240,048	62,1
3	3 STANDARD OIL ( N J )	12,191,405	109,0
4	4 GENERAL ELECTRIC	7,177,256	33,8
5	5 CHRYSLER	5,649,505	18,9

**All your printouts, that is! In Wilson Jones HANGER Binders with built-in retractable hangers. In your dealers' stock... Ready to deliver**

Now! The fastest, most convenient method of binding EDP printouts for suspension filing systems: Wilson Jones Nylon Post *Hanger* Binders.

**EASY TO LOAD**—Bind "tab" sheets exactly the same way as in all other WJ Nylon Post Binders.

**EASY TO USE**—Just extend the slide hangers for suspension; push them in, out of the way, during reference on desk or counter tops.

**AND THERE'S NOTHING TO ADD... NO EXTRA HANGERS NEEDED ... NOTHING MORE TO BUY!**

Wilson Jones Nylon Post Hanger Binders speed retrieval, reference, and re-filing. Designed for top and bottom loading of 14<sup>7</sup>/<sub>8</sub>" x 11" (or smaller) unburst marginal-punched sheets, they can be hung in Wilson Jones "Data-Racks," "Data-Centers," and "Data-Stations," as well as other suspension housing equipment.

GET THE HANG OF IT TODAY... Immediate delivery from your Office Products or Data Processing Supplies Dealer. Or write for full information.

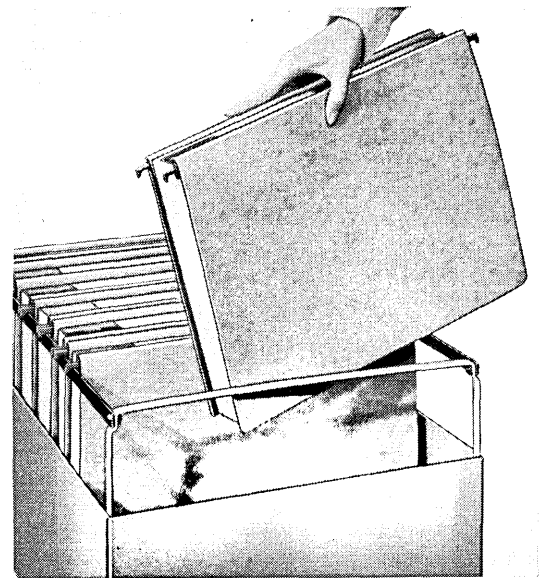

**WILSON JONES**  
Inventor of the Nylon Post Binder



A Division of *Swingline*, Inc.  
6150 TOUHY AVENUE · CHICAGO 60648



**3M takes  
the next step.**

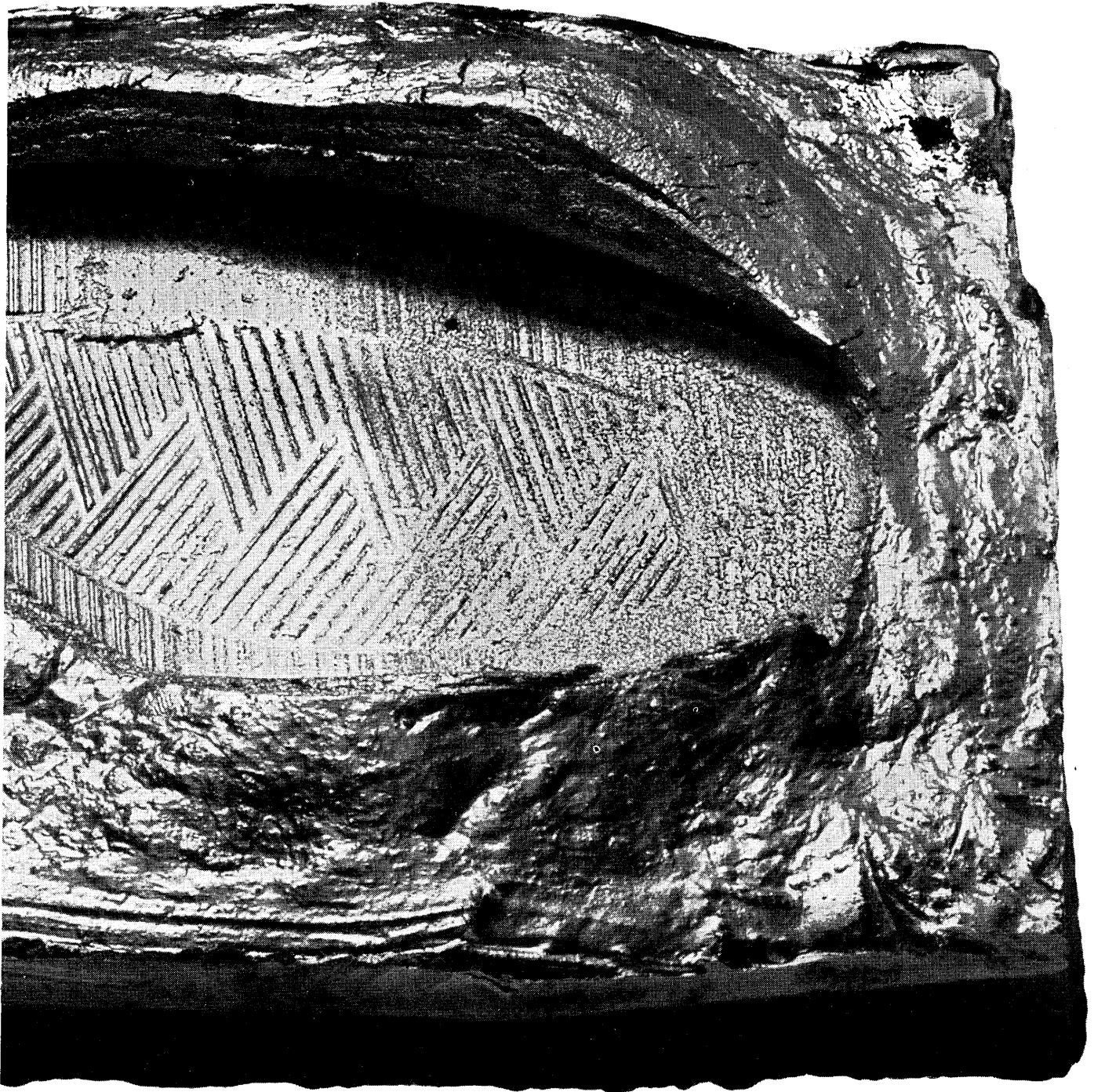

# Computer tape that guards itself.

Now, from the pioneers of computer tape, comes another major breakthrough in tape technology. A new "Scotch" Brand computer tape that effectively resists physical handling damage! There's more to come, but for advance information, write Market Services Dept., Magnetic Products Division, 3M Center, St. Paul, Minn. 55101.

**3M**  
COMPANY

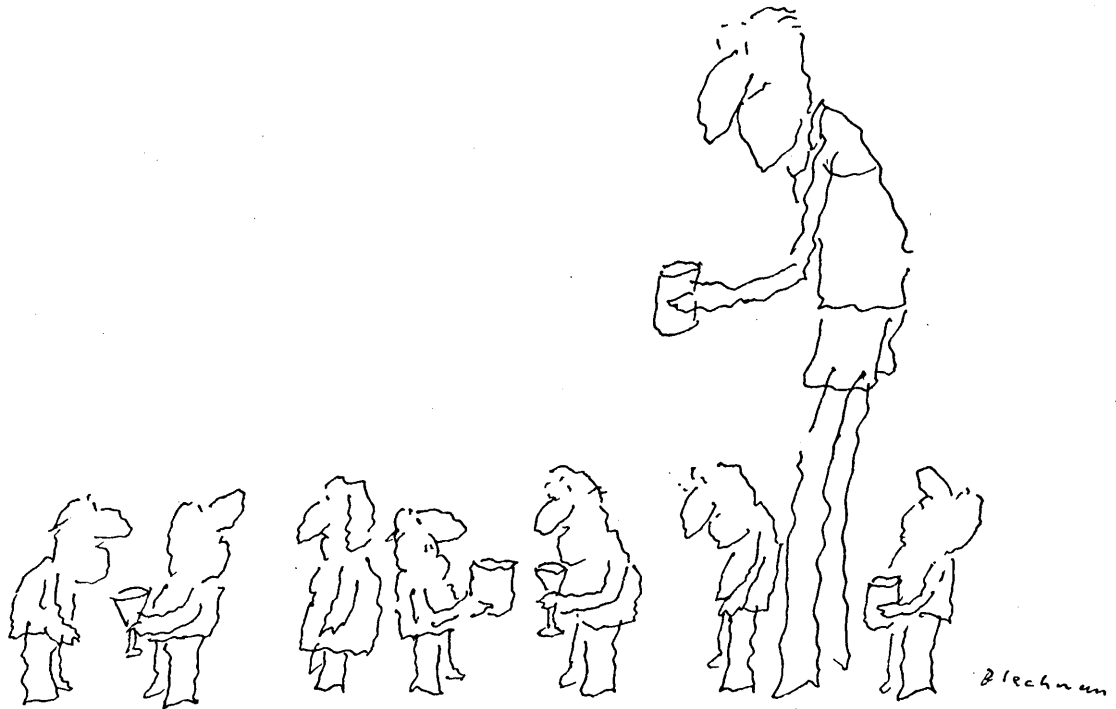

# PDP-15 is a basketball player at a dwarf convention.

In the world of middle size computers, PDP-15 is unusual. It is monitor controlled. It comes in 4 versions to fit budget and application. Its software is complete, voluminous, proven in 400 already-installed computers. And it is roughly half the price of machines that claim to be equivalent. That makes it a giant. Write.

**digital**

COMPUTERS • MODULES

Digital Equipment Corporation  
Maynard, Mass. (617) 897-5111





# Letters

## **picky, picky**

Sir:

Concerning News Scene, Dec. '69, p. 193, first column:

How can one save more than 100% on anything?

Clarification, please!

WALTER J. SAMEK

Ed. reply: For 200%, read 50%; for 500%, read 80%; for 300%, read 66⅔%; for 400%, read 75%. Our Washington editor, Phil Hirsch, always gives us 110%.

## **root at the matter**

SIR:

REFER YOUR NEWS SCENE DECEMBER ISSUE PAGE 193, COMPARING MA BELL ANDVXXX DATRAN RATES. 500% SAVINGS???? RUSH SALESMAN WITH CONTRACT PAYING ME 4 DOLLARS WHERE IT USED TO COST ME 1 DOLLAR. THIS RATE PHILOSOPHY UNPRECEDENTED BARGAIN. CONGRATS SIGNIFICANT YEAREND MATHEMATICAL NEWSBREAK. CONSTANT READER.

JOHN S. ROOT

SCARBOROUGH ONT. CANADA

## **top spot**

Sir:

Mr. William A. Bernstein's *tour de force* on "Palindromic Programming" in your December issue (p. 123) has struck me simultaneously with the immense power of his concept and with the egregious incorrectness of the name he has applied to it. A true palindrome reads exactly the same forward and backward. Using Mr. Bernstein's distortion of the term, the most famous palindrome of all, "Able was I ere I saw Elba," would read backwards as, "Elba saw I ere I was able," a logical impossibility.

I should be reluctant to bring such a carping complaint against such an elegant conceptual triumph except for the fact that I was the leader of a small group that invented true palindromic programs at Lincoln Laboratory in early 1956. These programs, of course, do exactly the same thing forward or backward, which provides a very good check on their correctness. We also recognized a class of programs (which obviously includes Mr. Bernstein's concept) which would do something different, but also useful, when operated backward, but we certainly did not apply the term "palindromic" to

this class. In fairness, I should say that we did not specifically call out the inverse transformation as one of these different but useful things, since the generality of our work did not permit detailing all of the possibilities.

To show the scope of the work we were doing 14 years ago, I need only describe the Möbius programs that were also devised by my group. In these programs, the instructions had to be chosen in such a way that when the program was written on tape, the tape cut and joined end to end with a half-twist into a Möbius strip, and the resulting "loop" read in to a computer twice (the second time with each character, including parity bit, backward). The result was a program, twice as long as the original, which did useful work all the way through. A trifling modification was required in the tape transports, of course, and the tape had to be readable from both sides, but these did not seem too great a price to pay.

It does not take a giant intellect to see that if this technique were enforced throughout the industry, first, the number of programs written would decrease sharply, a great boon in itself, but second, the amount of tape used would be cut in half.

Alas, a short-sighted management, in an access of false economy, shut off funding to this vital research before the work could be brought to fruition. I cannot express my joy over the fact that IBM has had the wisdom to support Mr. Bernstein in his important work. It is only by quantum jumps in technology of this sort that *os/360* can be brought to practice.

As a matter of interest, I should like to point out to Mr. Bernstein that he has failed to grasp the self-checking feature of his concept. It is clear that if the output of a forward run is fed in as input to a backward run, and if the resulting output is the same as the original input, we have clear proof that there is nothing wrong with the program.

In closing, I wish to record my recurring amusement with the fierce, new young breed of programmers. They don't seem to know that all of the worthwhile ideas in data processing were conceived, *in principium*, at Lincoln Laboratory in early 1956.

ROBERT A. MOSIER

Santa Monica, California

## **!hah!**

Sir:

If a palindrome is a word or phrase that reads the same backwards as forwards (e.g., level), would not a palindromic program that produces the  $n^{\text{th}}$  root executing forward and the  $n^{\text{th}}$

power executing backwards (rather than the  $n^{\text{th}}$  root again) be buggy?

VINCENT MARIER

Laurel, Maryland

## **gag**

Sir:

"Palindromic Programming," a beautiful Christmas put-on by William A. Bernstein. I bet you get at least a dozen letters from indignant patsies.

MILLARD H. PERSTEIN

Santa Monica, California

## **ono**

Sir:

Is Mr. Bernstein serious or is his article a subtle spoof on fourth-generation technology? Extracting the  $n^{\text{th}}$  root by executing the  $n^{\text{th}}$  power subroutine in P-mode is understandable, has obvious merit and shows considerable ingenuity and original thought on Mr. Bernstein's part.

When he starts talking of error recovery and program downdating, however, it is obvious that "the author has not been exposed to numerous areas of programming technology." When you move in new data, it *replaces* the old data. Has Mr. Bernstein never heard of the proverbial "bit bucket"? When creating a level 0 tape from a level 1 system, just where are those old bytes going to come from? Does he propose making every byte in the system a last-in, first-out queue? If so, how many levels does he want to provide for? Doesn't he realize that  $n$  levels would be analogous to  $n$  backup tapes? That being true, where's the economy?

Unless Mr. Bernstein has discovered some mystic circuitry for picking old bytes out of thin air, I hope he doesn't inflict his "logic" on *my* future *os* release.

R. J. OPPENHEIMER

Atlanta, Georgia

## **gaposis**

Sir:

My associates and I have been unable to reach an agreement on the definition of the terms "first, second, and third generation" as applied to computers. We seek your aid in resolving our differences in opinion.

I and several others state that the generation to which a computer belongs is determined by the hardware (i.e., whether the computer is made of tubes, transistors, or integrated circuits). Other groups state that the generation is determined by the type of software the computer is able to handle (assembler v. compiler level languages), or the types of applications the computer is put to (batch processing, time sharing, etc.), or just the manufacturer's whim so that he



# A LITTLE BIT EXTRA

# ...FROM MAGNAFILE.

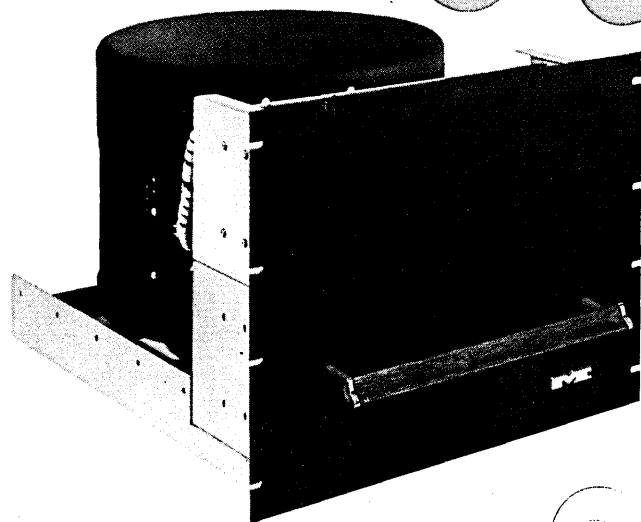

The Model 8502, Magnaflex's low-cost memory system, offers you memory storage from 1.25 million to 5 million bits.

Like its big brother, the Magnaflex Model 9330, this head-per-track system features proprietary nickel-cobalt plating, conservative data densities, and state-of-the-art recovery techniques to provide a highly stable data base.

If you've been looking for a reliable, low-cost memory system without success, your search is over. Magnaflex has it for you in the 8502...and you get a little bit extra in the bargain!

Call or write today for complete technical specifications.



2602 EAST MAGNOLIA STREET  
PHOENIX, ARIZONA 85034  
TELEPHONE: (602) 275-3607

## letters . . .

may impress potential customers by claiming computers of the  $n^{\text{th}}$  generation.

No group has been able to convince the other that it is correct because, so far, no one has found any written material explaining the whole computer industry's stand on or definition of our field's generation gaps.

Perhaps your readers have some ideas.

J. CZARNUSZEWICZ, DP3  
Dam Neck, Virginia

### kitchenware software

Sir:

Concerning the sale of kitchen computers by Neiman-Marcus, as reported in your issue of December '69, page 215:

We are well pleased with our S-316 Komputer, manufactured by the Sugarspring Komputer Kompany. Our table-top model costs \$10,600 E-5 (10.6 cents). Hardware consists of a shoe box, pencil, and unit record cards. The cards are read optically. Not only menus but also recipes (and even love notes to the wife) may be programmed. Software is abundantly available in various cook books.

A. MOSES  
El Paso, Texas

### topless management

Sir:

In regards to Mr. Spett's article entitled, "Standards For Evaluating Data Processing Management," which appears in your December issue (p. 171):

I find Mr. Spett's effort of mixed value. His good points are negated by his propensity to make immature assertions towards his boss. His boss in this case is "top management." The eleven concluding critical questions summarize Mr. Spett's positive contributions quite adequately; however, his failure to fully develop them in the main body of his article is accentuated by his recurring comments on misunderstanding or ignorant "top management."

For example, his "There is a tendency for management, especially top management, to pass around the crying towel and complain about the failures of the 'computer people,'" and, "The only time a project can be truly said to be late is when the analysts have wasted time through lack of initiative or poor planning" demonstrates an attitude perhaps best described as "we can do no wrong and they can do no right." This is reinforced by his "But in order to properly execute this

responsibility, the systems analyst must be brought into the mainstream of company business. They must be treated not as computer technicians, but rather as experts in finance, marketing, distribution, and production."

Perhaps if Mr. Spett, with time, were to develop a little more experience in the problems and considerations concerning "top management" he would reach somewhat different conclusions than "Many managers institute elaborate reporting systems because they have no faith in their own subjective judgments. . . . Top management must resist the temptation to accept charts and statistics as evidence of progress."

STEPHEN J. ROBINSON  
Cambridge, Massachusetts

### all aboard

Sir:

I was pleased to see the report on the AAR Data Systems Conference (Nov. p. 246). This is only the second time I can recall seeing an article on the data systems division in a national publication. Perhaps this lack of contact with the press is responsible for the poor hospitality extended Mr. Rolph. I hope this doesn't deter DATAMATION from

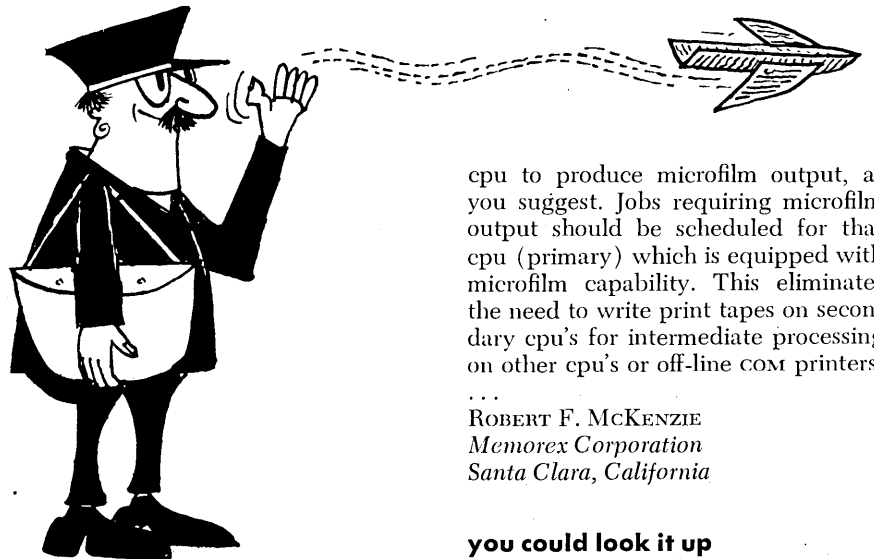

### read the manual

Sir:

Regarding Mr. Howard Edelman's "A Short Guide to the Wonderful World of COBOL" (Dec., p. 161), and the long list of possible future enhancements to the COBOL language, may I suggest that CODASYL read the PL/I Version 4 Manual. Much of their work has already been done by IBM.

M. CHAMBREAU  
Palo Alto, California

### com on

Sir:

Your article on the Memorex 1603 Microfilm Printer (Nov., p. 420), in addition to containing several inaccuracies, warrants clarification to best serve the interests of your readers. Specifically, the 1603 uses the standard IBM 64 Char, EBCDIC input, not ASCII as your report indicated. Deliveries are scheduled to begin in 1st quarter, 1970, not "immediately." The 1603 accepts data at transfer rates up to 500 KB/sec rather than 1,320/DC/sec. . . .

Printout tapes from a "secondary computer" need not require an intermediate step involving the primary

cpu to produce microfilm output, as you suggest. Jobs requiring microfilm output should be scheduled for that cpu (primary) which is equipped with microfilm capability. This eliminates the need to write print tapes on secondary cpu's for intermediate processing on other cpu's or off-line COM printers.

ROBERT F. MCKENZIE  
Memorex Corporation  
Santa Clara, California

### you could look it up

Sir:

Your very interesting issue (Dec. '69) on COM dismayed me a bit because I was quite unaware of the "fact" that computer output on microfilm was "new." Although passing reference is made to the sc-4020, Stromberg-Carlson's forerunner of their DatagraphiX, it is treated as an obsolete, old-fashioned device. As an erstwhile user of the sc-4020, I can testify to its versatility, low cost (on rental, anyway), and excellent performance characteristics. As I recall, its output speed was something like 17,250 characters per second (in typewriter mode). Its

(Continued on p. 261)

reporting on future conferences or on the forums held each year in January and June.

One minor correction on the number of railroad cars. The railroads have approximately 1,550,000 cars (including locomotives) that must be labeled for automatic car identification. Private owners (non-railroad) are responsible for an additional 270,000 cars.

JOSEPH F. WIXTED  
B&O/C&O Railroad  
Baltimore, Maryland

**You already own  
thousands of these  
efficient  
data-gathering devices.**

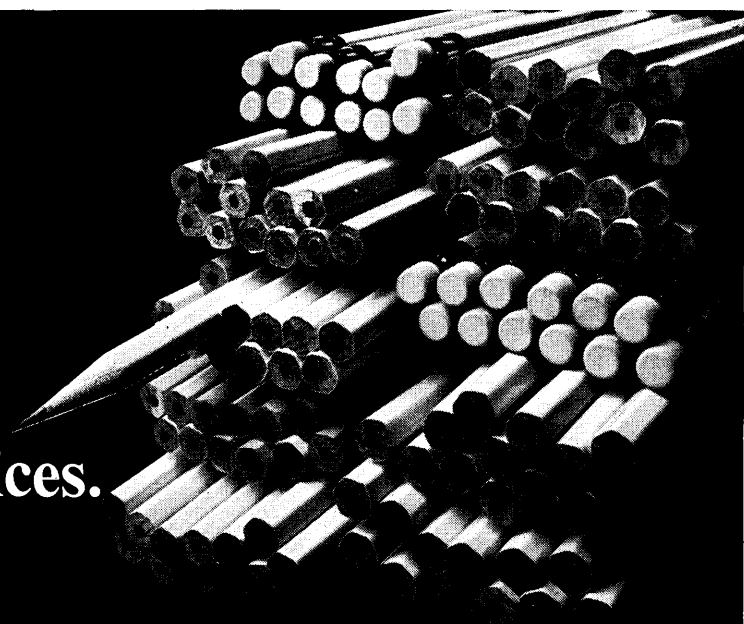

**To make them computer-compatible,  
all you need is**

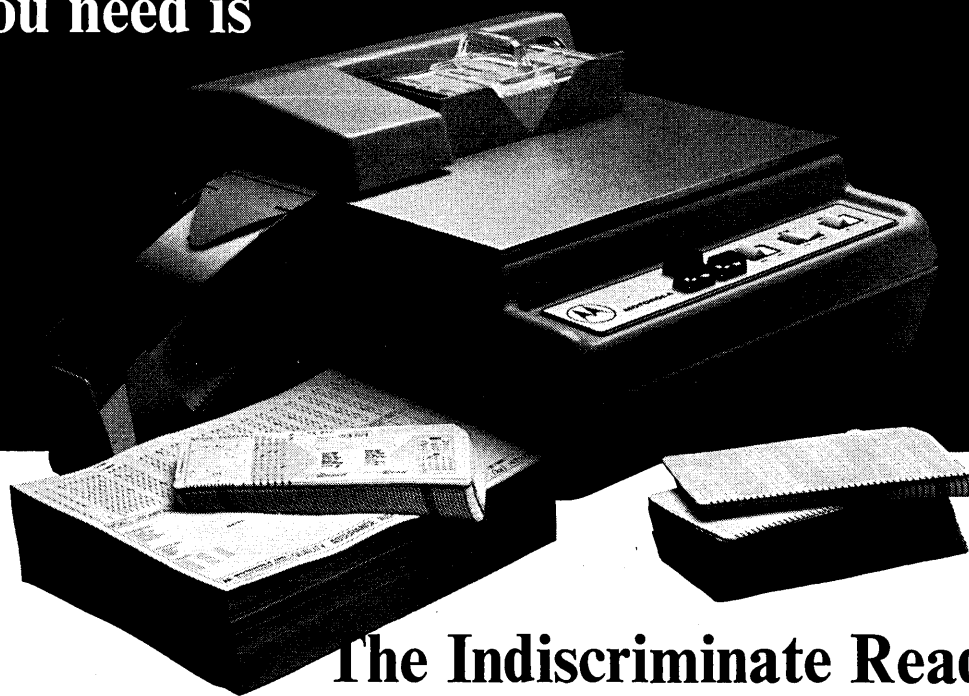

## **The Indiscriminate Reader.**

Pencils. Ordinary, everyday pencils.  
No special training required to use them.

The Motorola Indiscriminate Reader reads ordinary pencil marks. On tab cards. On page-size documents. On snap-out forms. On any kind of document, really, that you might need.

It also reads keypunched data. And pre-marked data. All three combined, on a single form, if you like.

It outputs to mag tape, teleprinter, or to standard modems for remote communications.

Surprisingly, The Indiscriminate Reader doesn't cost an arm and a leg. To buy or to lease. Prices start at \$3600. Lease rates are similarly moderate.

Spec sheets and application data are yours for the asking. Drop us a note. Pencil will do just fine. Motorola Instrumentation and Control Inc., Subsidiary of Motorola Inc., P.O. Box 5409, Phoenix, Arizona 85010.



**MOTOROLA Information Systems**

4381

# For less than \$5,000 we can put your computer on television.

Here's your chance to get a video terminal for your computer for less than \$5000 (or on a low cost lease plan.)

Ultronic's low-cost stand-alone display is completely compatible with your IBM 360 and can be adapted to other computer installations.

The Videomaster™ 7000 gives you a total of 960 displayable alphanumeric characters and a full alphanumeric keyboard. You get full edit control.

In addition, we can give you format

and hard copy options.

And it's small too. The entire display monitor takes up just 1 square foot of desk space.

Ultronic has over 12,000 on-line terminals in operation throughout the world. And we have the service facilities to back them up. Our trained technical force, based in major cities is available for installation, service, and maintenance.

And you get all this for less than \$5000.

Doesn't it pay to give your computer a

television career?

Call us collect. (609) 235-7300.

Or write Data Communications Products Division, Ultronic Systems Corp., Mount Laurel Industrial Park, Moorestown, N.J. 08057.

**ULTRONIC SYSTEMS**

**SYLVANIA**  
GENERAL TELEPHONE & ELECTRONICS

CIRCLE 84 ON READER CARD



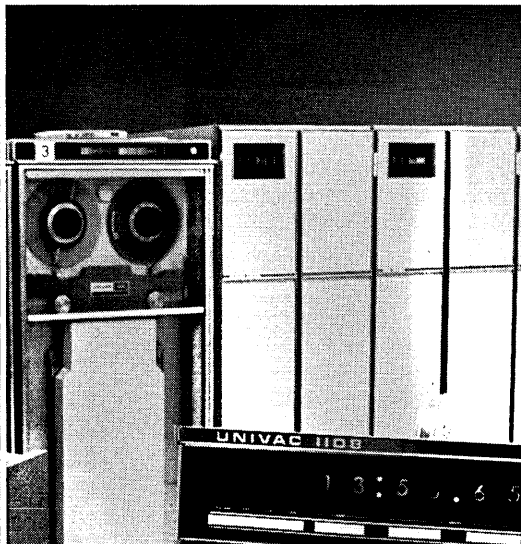
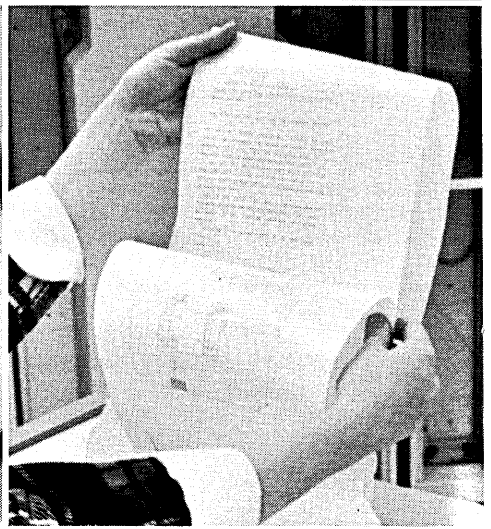
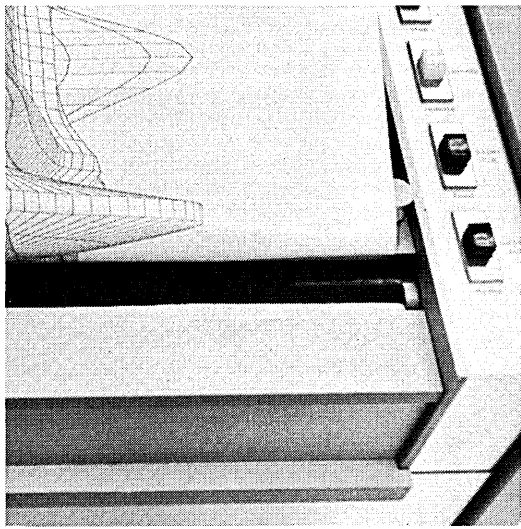
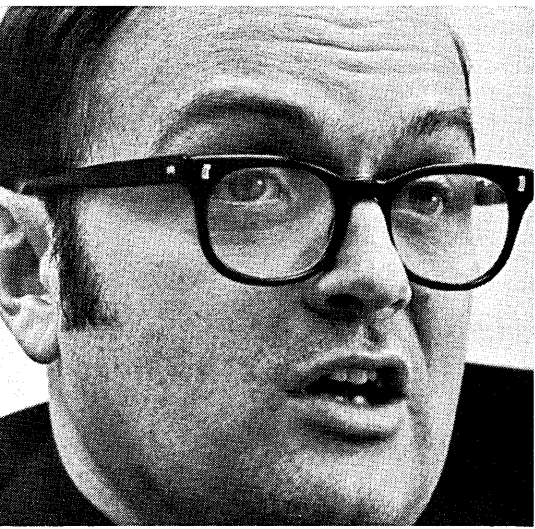
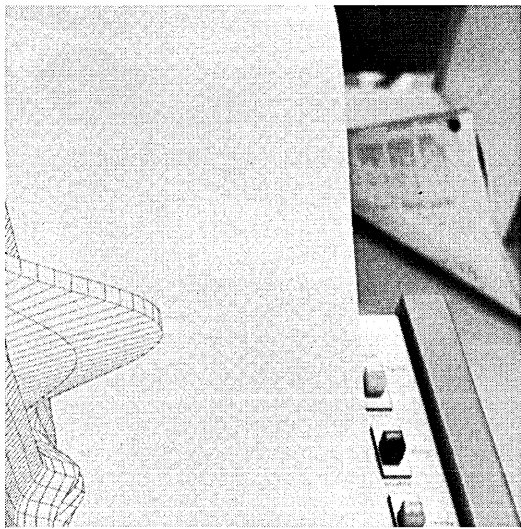
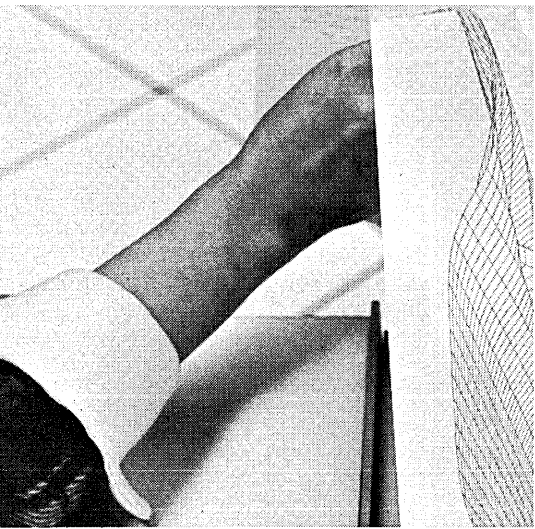



# "The Clevite electrostatic printer increases our printout capability anywhere from eight to two hundred times."

That's how Mr. Stanley Y. Curry, President of Chi Corporation sums up their experience with the Clevite 4800 hardcopy printer.

A Cleveland-based computer service firm founded by Case Western Reserve University, Chi wanted a fast, versatile printer to complement its third generation Univac 1108. Chi uses its Clevite 4800 printer to perform a wide variety of highly sophisticated scientific and engineering computations, for both the university and over 100 customers currently using the firm's many services.

Here are some more of Mr. Curry's observations . . .

"We use the Clevite 4800 in three principle areas . . . text editing; intermixing text and pictures; circuit diagrams, plotting and perspective drawings. Currently, we're experimenting with applying it to our billing procedures and are exploring its use for high-speed label printing. It looks as if the printer is useful for just about any output.

"Take text, for example. The 4800 is ideal because of the speed with which it provides copies. Change, delete, add, then program the computer accordingly. Almost instantly the electrostatic printer provides a clean copy of the edited material.

"Our experience with core dump has been quite impressive. Here is an area where the printer's diagnostic

ability really comes to play. Our computer stores some four million binary bits of information, and core dumping used to take around twenty minutes. With the Clevite Printer, we're now completing a core dump in just two minutes," Mr. Curry concludes.

#### **MORE FACTS ON THE CLEVITE 4800**

Clevite 4800 reproduces signals from any source of digital input or data transmission by telemetry, radio microwave, and/or land line. It produces accurate printouts of both alphanumerics and graphics almost as fast as the computer supplies them.

A productivity rate of 412,000 characters per minute means fast-acting computers are no longer hampered by mechanical equipment, noisily hammering out a few hundred lines per minute.

No other printer gets as much out of your computer as fast as Clevite 4800. And no other printer is so economical. The Clevite 4800 reduces capital investment, because conventional equipment costs more per unit. Also, there are few moving parts, reducing the need for constant maintenance and servicing. Clevite 4800. It's faster, more versatile, quieter, and more dependable than anything else you can buy.

Drop us a line to find out how it fits into your computer room. Graphics Division, Gould Inc., 3631 Perkins Ave., Cleveland, Ohio 44114.

## **GOULD CLEVITE**

Clevite 4800. The next generation of high-speed printers.

CIRCLE 174 ON READER CARD

# One computer company offers you these six ways to improve plant performance.

**1. BICS**, the inventory management system that helps you respond to unexpected conditions

**2. PROMIS**, the project-oriented management information system that lets you keep track of one project, or many, in whatever detail you want

**3. ACTION**, the physical inventory system that monitors all inventory transactions and "looks ahead" to warn you of off-schedule conditions

**4. PRODUCTION CONTROL**, a system that provides a view of the whole production planning and control process, from requirements planning through work-in-process to product shipment

**5. NUMERICAL CONTROL** systems, with ADAPT-RX and APT-RX compilers for 3-axis and 5-axis control, plus post-processor programs for major brands of machine tools

and

**6. '500' Series** computers and disk file systems, logical companions to these outstanding industrial program packages.

The company is BURROUGHS.

For more information, call our local office, or write to us in Detroit, 48232.

**Burroughs** 

# look ahead

---

## DOD TO TAKE BIDS FROM SE SUPPLIERS

DOD told all of its IBM-installation managers last month to obtain SE and training help via competitive bid, if possible, instead of negotiating sole source arrangements with Armonk. GSA issued approximately similar instructions to IBM-using civilian agencies.

These instructions may help independents — leasing companies were specifically mentioned — to get SE contracts from operators of larger military and civilian systems (360/50 and above), according to a knowledgeable source. Smaller-system operators, he adds, should have little trouble proving that sole sourcing is more economical.

DOD specifically forbade its dp managers from negotiating personal service (open-ended) contracts for SE services. DOD and GSA both said federal dp managers should not sign IBM commercial SE contracts.

The two pronouncements were inspired partly by the failure of IBM and GSA to agree on an FY '70 FSS contract. That agreement reportedly will be consummated "shortly." But even afterward, the feds will continue to insist on competitive procurement of unbundled services, unless IBM agrees to de-bundle them for government customers. Such a concession is not considered likely.

## FOUR-PHASE PHASES IN NEW MIDICOMPUTER

The prototype is ready and so are plans to introduce a new midicomputer developed by Four-Phase Systems, Inc., Cupertino, Calif., which is headed by Lee Boysel, formerly manager of the MOS/LSI design engineering section at Fairchild. And MOS/LSI is used exclusively throughout the new machine, which can be multiaccessed, enabling it to drive a cluster of 32 crt keyboard terminals with "their support electronics pulled back into the semiconductor memory and shared among the cluster." During the development of its computer, Four-Phase maintained "complete" control over the topological layout of the LSI chips, maintaining its own mask making, wafer handling and packaging areas prior to testing of the finished LSI packages . . . which seems to be an answer to the problem of how to control MOS supply: Make your own.

The machine is described as a little faster and more powerful than the HP 2116A and the Honeywell 316, with a longer word length (still secret) than any of the minicomputers. Price, still to be decided, will be from \$10-15K.

## WANT TO SAVE MONEY? THEN CALL YOUR BROKER

With the economy stalling out and even IBM reporting lower net for the last quarter, this might be the year of triumph for the second-hand computer dealers.

*(Continued on page 51)*

# rated number one!

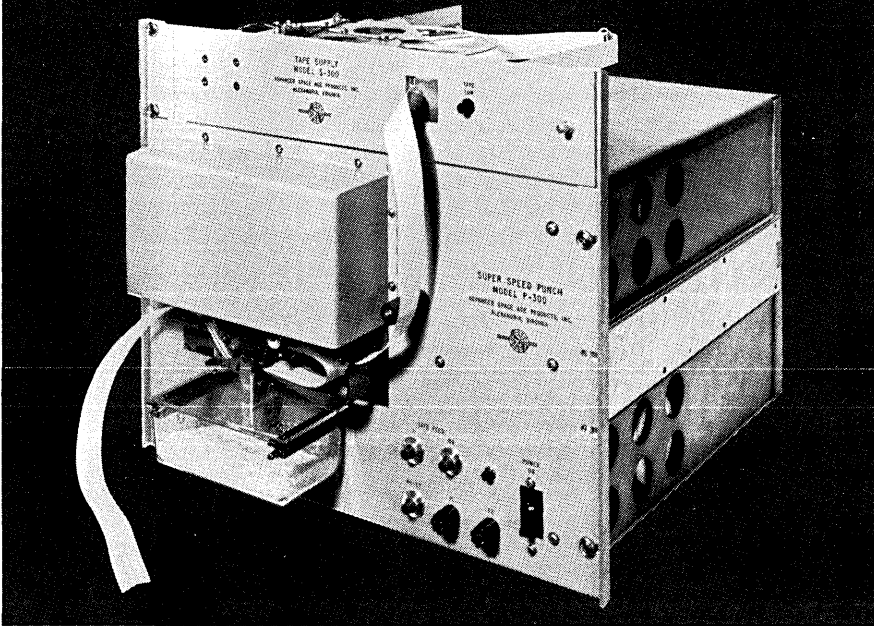

**To be No. 1 takes speed, price, reliability and delivery.** ASAP's Model P-300 Paper Tape Punch is rated Number One because it is designed to meet the following specifications:

**No. 1 Speed:** 310 characters per second—paper or mylar tape  
**NO. 1 Price:** \$3,500, complete with electronics, logic level input, power supply, and tape supply handling controls.

**NO. 1 Reliability:** One year warranty  
**NO. 1 Delivery:** 60 days

Designed for outstanding performance, the Model P-300 operates at a speed of 310 characters per second using either paper or mylar tape. This automatically synchronized punch features a 1,000 ft. horizontal reel within a 3½" x 19" hinged panel tape supply. Other features include

slides for rack mounting (standard), single and multiple feeds for easy reloading of tape, tape alarms for low, slack or tight tape conditions.

Optional features for the Model P-300 include: advanced feed hole, long-life punch blocks and verification punch blocks. P-300 punch head and tape supply available for \$1,500. ASAP's Model 240 is available for operations that do not require over 240 characters per second punching speed.

Specify the NO. 1 Punch . . . ASAP's Model P-300

For complete information contact:  
Morris Bowles  
Advanced Space Age Products, Inc.  
4308 Wheeler Avenue,  
Alexandria, Virginia 22304  
Tel.: (703) 751-3320

A subsidiary of Telegraph Equipment Corp.



**ADVANCED SPACE AGE PRODUCTS**

## look ahead

If so, big Jim Gehling of Business Computers, Inc., in Dallas is ready.

In business on a limited scale for about two and a half years, the company has now assembled five brokers with combined IBM and leasing company experience — biggest staff of peddlers in the business, according to Gehling. And they've set up a \$2.6-million line of credit with a stock issue planned later. The company, which deals in all IBM unit record equipment and computers, has a policy of "no-risk" leasing: the terms of the noncancellable contract cover all expenses, recovery of the principal, plus a profit. Or they'll take cash. What the customer gets in return is a refurbished machine that he doesn't have to pay for until it's installed and on an IBM maintenance contract. Gehling has a warehouse and a shop—and has taken the trouble to submit the famous IBM gray paint to spectrographic analysis for exact duplication.

There are two main problems, Gehling says: locating the machines to buy and correcting the tarnished image some people have of brokers. Maybe to help with the latter problem, he has a board member who is also on the board of the Baptist Theological Seminary. This is probably the only brokerage that can make this claim.

### DATAGRAPHIX REDUCING ITS IMAGE

Stromberg Datagraphix is slimming down. The San Diego-based microfilmer manufacturer has already cut more than 300 people from its payroll and is closing one of its five regional offices. This kind of reducing is strange to a company that has seen 1969 sales figures soar to \$28 million from '68's \$18 million. Current backlog is reportedly around \$25 million.

Pressure on the parent firm, General Dynamics—with cash flow problems, facing a possible F-111 contract cancellation and a proxy fight—reportedly triggered the cuts. Optimistically, the diet is also seen as part of a program aimed at making SD more attractive to suitors. GD is also looking at spinning off Datagraphix and letting it go public—with GD's stock diluted or held in trust. In the meantime, unfortunately, SD is losing good people, including directors of finance, marketing and engineering.

### TWA STICKS WITH BURROUGHS

We erred last month in printing that TWA was considering a new system or new vendor for its multimegabuck on-line reservations system. The airline will stay with Burroughs and the D-830 (now called the B-8300). Though operational date is not yet set, TWA says that its 3-cpu configuration (up from the planned two) is running efficiently. A fourth cpu may be required. A story oft told, software and increased scope of job have been the problems. TWA is looking for a separate system for automatic ticketing and fare computation, however.

### MULTICS MOVES ALONG, EYES FED FUNDING LAW

University projects, like MIT's MAC, are waiting to see what interpretation will be given to the congressional mandate that all Defense Dept. research work have military relevancy. But observers don't think the ARPA-funded MAC or graphics work going on at the U. of Utah and elsewhere will be impacted.

At MAC, the Multics project, opened to school-wide use in October, has 250 registered users on the GE 645, the growing number doing everything from

*(Continued on page 233)*



# Brand X can't deliver...

**We do.**

You may have noticed that when it comes to deliveries, COM system manufacturers promise the moon — but they're having trouble making the countdown. On the other hand, UCC series 300 Microfilm Plotter/Printers were first announced in October. You saw them in action a month later at the FJCC. Now we're telling you we're delivering hardware . . . not promises!

# and they're too high priced

## We aren't.

Now . . . if delivery doesn't boggle your mind . . .  
price will. Take one well-known COM manufacturer. Their  
systems cost approximately 50% more than ours. At their  
price, it could take a year or more for the system to pay  
for itself. With the UCC 300 series . . . it might  
just take you six months.

But don't take our word for it . . . make us prove it.



**UNIVERSITY COMPUTING COMPANY**

**GRAPHIC SYSTEMS DIVISION**

14761 Califa Street  
Van Nuys, California 91401  
Telephone (213) 781-7100

CIRCLE 82 ON READER CARD

**HOW SWEET IT IS!**



**MCS TELECONTROL**

**WTI Converts the new IBM MAG CARD SELECTRIC\* into a data communications terminal for \$75/month.**

Destined to be the most useful office equipment ever presented, the IBM MAG CARD SELECTRIC provides simple, efficient text editing and storage on 5,000 character magnetic cards. With a touch of a button . . . a WTI MCS TELECONTROL Unit converts it into . . .

**. . . A TIME-SHARED COMPUTER TERMINAL**

Interchangeable with the IBM 2741 or equivalent terminal on any time-shared service such as CALL/360 or an in-house system. MCS TELECONTROL stores, recalls, edits and transmits programs and data up to 5,000 characters per card (equivalent to approximately 60 punched cards) under operator or remote computer control. A standard RS232B interface, acoustic coupler or an optional internal dataset for direct access attachment is available. Also converts punched cards to magnetic cards with a WTI CT41 Card Read Terminal. . . .

**. . . AND THE FIRST SECRETARY ORIENTED INTRA-COMPANY MESSAGE SYSTEM**

Transmits and receives messages from similarly equipped units over switched or private telephone systems for really fast memo and correspondence work. Transmits, records and types messages right from your secretary's desk . . . 500 to 600 words between Los Angeles and New York for less than \$1.50!

**ATTENTION S/360 USERS:** Getting ready for IBM's new Interactive Terminal Facility (ITF) or the Time-Sharing Option (TSO) for in-house use? An MCS TELECONTROL CONVERTER is compatible as a remote terminal!

Call your IBM Office Products sales representative for a demo of the MAG CARD SELECTRIC . . . and WTI for an MCS TELECONTROL Converter . . . today! Installs without modification —does not affect your IBM standard maintenance agreement. Sold and serviced nationally.

\*tradenames of the International Business Machines Corp., Armonk, N.Y.

**SALES OFFICES:** Western Telematic Inc. is exclusively represented by the DECIMUS CORPORATION. For customer service in your area contact DECIMUS at one of the following:

**NEW YORK** 261 Madison Avenue • New York • New York 10016  
(212) 986-0230

**CHICAGO** 9575 West Higgins Road • Rosemont • Illinois 60018  
(312) 696-4490

**DALLAS** 2930 Turtle Creek Plaza • Dallas • Texas 75219  
(214) 521-5050

**HOUSTON** 80 Interstate 10 N. • Beaumont • Texas 77706  
(713) 833-7479

**ATLANTA** 1 Corporate Square • Atlanta • Georgia 30329  
(404) 631-3163

**SAN FRANCISCO** One California Street • San Francisco • California 94111  
(415) 391-4350

**LOS ANGELES** Western Telematic Inc.  
5507 Peck Road • Arcadia • California 91006  
(213) 442-1862

**WTI**

**western telematic inc.**

5507 PECK ROAD • ARCADIA • CALIFORNIA 91006 • PHONE (213) 442-1862

# The second revolution in computer time sharing continues.

And we're winning it.

■ **The AL/COM interactive time sharing network will electrify every sophisticated computer user in the United States.**

AL/COM now gives you more interactive computing power with faster response time, than any other time-sharing system . . . 32,000 36-bit words per user. Cycle time one microsecond. Your access to this increased computer power is instantaneous and direct. Through your telephone. Privately. It's a "tough-job" system and it has the best price/performance ratio there is.

■ **AL/COM has a policy about insoluble time sharing problems. We solve them.**

We're after the tough jobs, the big ones. We're talking about price/performance . . . good response time . . . and freedoms that time-sharing hasn't granted you before. Things like:

**Core Capacity** — AL/COM gives you 160,000 characters (32,000 words) in active core per user.

**On-Line Storage** — AL/COM has a billion characters of disc storage.

**Large Files** — AL/COM gives you 1,250,000 characters per file.

**Fast Access** — AL/COM can search a 2.5 million character bank in seconds.

■ **The things you can do with AL/COM time sharing are limited only by your imagination.**

AL/COM has the bugs worked out. We've been up for 3 years. We can connect you with teletypes, line printers, CRT's and multiplexers. We speak eight languages . . . BASIC, FORTRAN IV, COBOL, etc. We're adding others. AL/

COM solves problems in science, engineering, and banking. It's for operations research, marketing and statistical analysis, and bridge building . . . for management information, investments, and manufacturing. We even do little problems well.

■ **When comparing time sharing services, you can't include AL/COM with the others.**

AL/COM service stands out because we've interlaced a string of multi-processing AL-10 systems, with one computer backing up another in each system, and a second dual system backing up the first . . . and we'll soon have ten. They're all side by side, but as close as your local phone. Think about that . . . central files . . . back-up . . . speed . . . reliability . . . distributed nationwide by the AL/COM Time-Sharing Network.

■ **When you select AL/COM you get a nationwide network of computer software professionals.**

We bring AL/COM to you through a nationwide network of professional software organizations. We're more than reps, dealers or branch offices. We're AL/COM Associates; local, independent firms, among the best in the industry. Systems and applications expertise is an integral part of the AL/COM network. This means you have the largest group of independent computer software experts to help you solve problems more efficiently, right at your elbow . . . through AL/COM.

■ **In just 30 seconds, you can arrange for a demonstration of the world's best price/performance computer time sharing service.**

Experiencing AL/COM is believing. We'll benchmark AL/COM against your present system. Compare the response, the speed, the cost. Do you have a problem you can't solve on your present system? Try us. We're after the tough ones.

■ **It takes guts to start a revolution.**

Revolutions are started by people dissatisfied with the way things are. Success depends on a change for the better. That's what AL/COM is all about . . . and it's revolutionary.

Contact us for information or demonstration

## AL/COM

The Revolutionary Time-Sharing Network

AL/COM is a service of  
**APPLIED LOGIC CORPORATION**

One Palmer Square  
Princeton, New Jersey 08540  
(609) 924-7800

Call me  Send data

Name \_\_\_\_\_ Title \_\_\_\_\_

Company \_\_\_\_\_

Address \_\_\_\_\_

City \_\_\_\_\_ State \_\_\_\_\_

Zip \_\_\_\_\_ Tel. \_\_\_\_\_

# Time



# yourself.

## Read the results in FORTRAN, BASIC or COBOL.

Because the hardware takes its shape from the software, the IC-7000 offers some distinct advantages to users of time-sharing. You can mix or match sub-routines from different languages within the same program or build your own program language. The IC-7000 can handle FORTRAN, BASIC, COBOL and assembly language without degradation in any dialect.

It's a powerful, new fourth generation computer with a 256K-36 bit word core. Each user has up to 64K words available in core and can control access to his files at any security levels he programs including "inviolable."

Control and main memories are separate. All overhead tasks are segregated and handled in an economical manner while number-crunching tasks are slammed through tremendously fast, optimized areas. And the IC-7000 can handle

remote batch within the same framework, with no wired-in limitations in any mode.

Our Associative File System lets you call into core with addressing as loose as "Get me all the p's and q's and anything with an r."

Dynamic time slicing allows programmed self-modulation of queue times to pre-set optimums. And you can tie into TTY, CRT Selectric, Friden, concentrators or even other computers.

There has never been a time like this. For detailed information and full pricing/leasing schedules, contact Bill Otterson, Vice President of Marketing or any of our sales offices.

STANDARD COMPUTER CORPORATION, 1411 West Olympic Blvd., Los Angeles, California 90015 (213) 387-5267.

Chicago: (312) 726-0277; Dallas: (214) 239-9627; Denver: (303) 428-0529;

Detroit: (313) 352-1710; Minneapolis: (612) 926-0706; New York: (212) 661-1834;

Philadelphia: (215) 563-6350; San Jose: (408) 294-7150; Waltham: (617) 891-5083.

All software for the IC-7000 was developed in conjunction with Call-A-Computer, Inc.

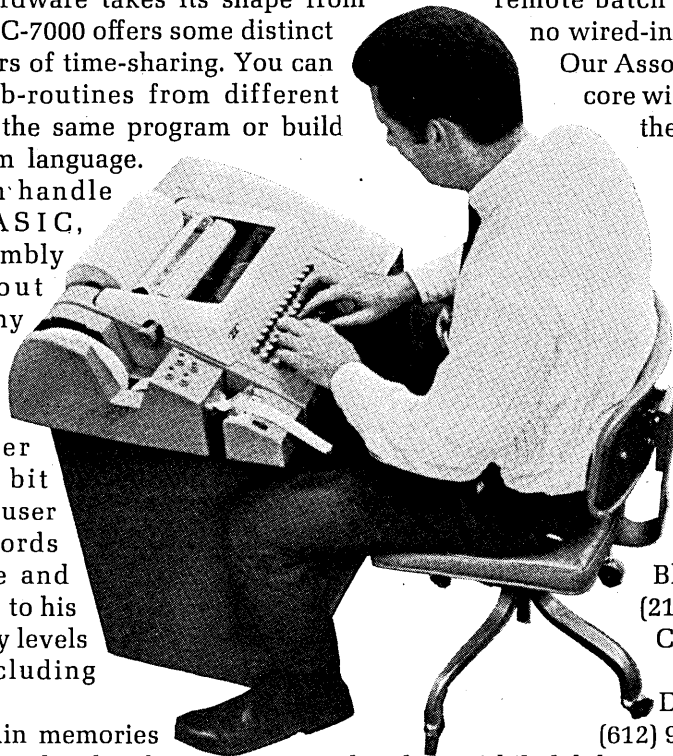

## Standard Computer

# Draw your own conclusions with this new time-share terminal.

Now you can have a time-share terminal that lets you see your data graphically— instantly — as it prints out on your Teletypewriter. Now you can plot for comprehension, for meaningful report illustrations, for permanent records. And do it while the time-share data's coming in.

The HP 7200A Graphic Plotter is the first major advance in time-share flexibility since the Teletypewriter itself. The Graphic Terminal feeds from standard EIA ASCII inputs and automatically plots computer data in points, lines, curves, bar graphs, pie

charts, or any other useful engineering, mathematical or business graphics you need. Plot directly from the Teletype keyboard, too, or silence the Teletypewriter and use the plotter alone. It's the end of the graphic time lag.

The HP 7200A is easy to use and requires no special operating or programming/language knowledge. It plots smooth lines, not the staircase drawn by the incremental recorder. And it lets you position the graph where you want it on any type or size of graph paper up to 11" x 17".

Talk to your time-share service about

Hewlett-Packard's new 7200A Graphic Plotter. If your service doesn't offer it yet, have them give us a call. The Graphic Terminal. For people who can benefit from a dash of art with their cold hard data.

HEWLETT  PACKARD

GRAPHIC RECORDERS

11921

CIRCLE 138 ON READER CARD

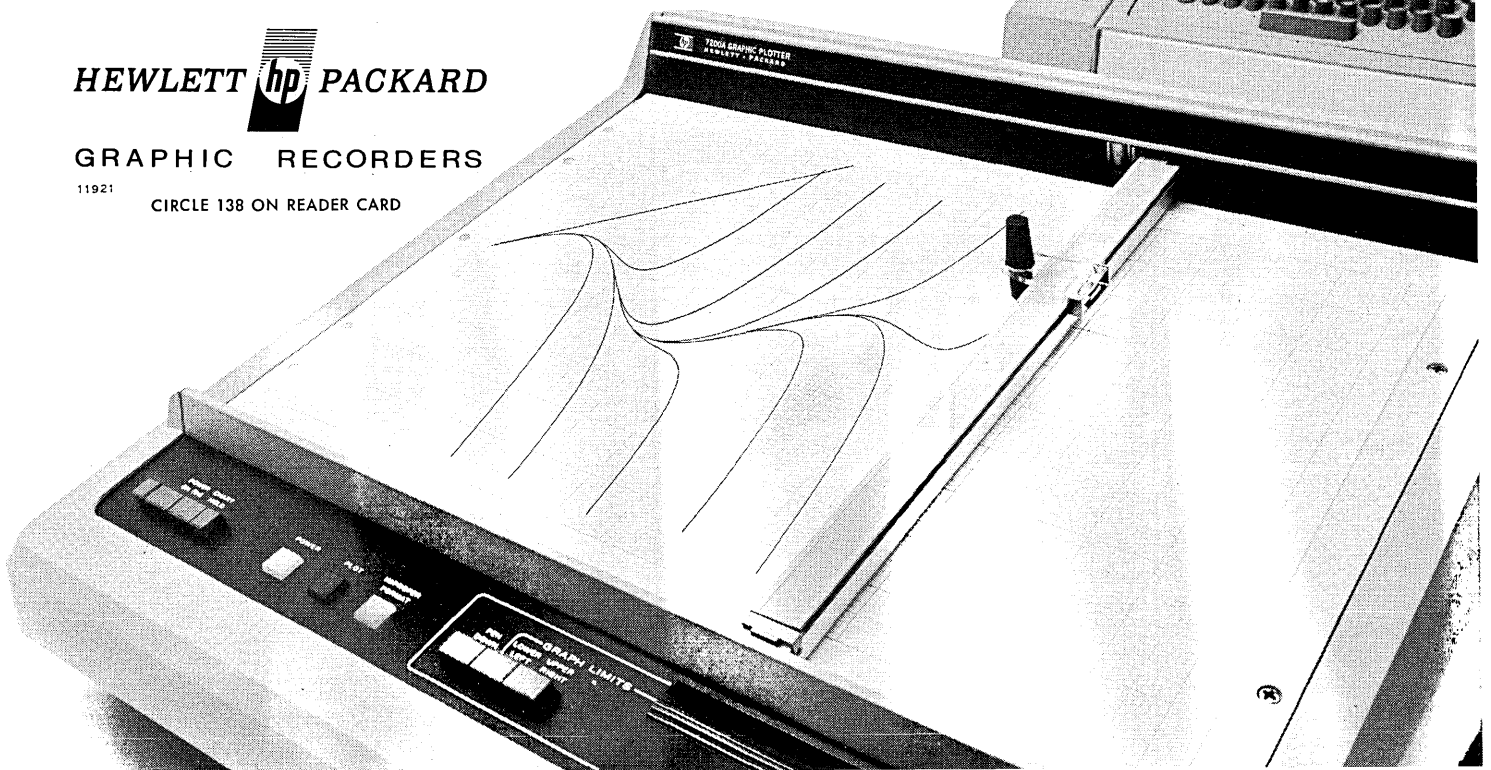

# editor's read<sup>ut</sup>

## PUT OUT MORE FLAGS FOR Z39

The quiet work of the dedicated individuals who are interested in standards and standardization is noticed only when it isn't done. Thus the wild proliferation of microfilm, microcards, and microfiche—different sizes, different reduction ratios, different formats (opaque and transparent, positive and negative)—put users in an impossible position. Much-wanted material was published in each of these forms, which meant that libraries could not escape buying reading machines (and reader-printers, too) for each different format. The problems of optics, sufficient light intensity, and dissipation of heat were difficult enough, but these were compounded by the complexity required by the incompatible formats. Then there was the problem of storage: special humidified filing cabinets, boxed and placed on regular library shelving, or what?

Last October the United States of America Standards Institute, Inc., changed its name to the American National Standards Institute, Inc.—to preclude confusion, since it might be assumed that the former represented an official government agency. Earlier names were the American National Standards Association and the American Engineering Standards Committee. But whatever the name, the work has always been the same: to establish standards wherever requested.

The ANSI is a voluntary organization, a federation of trade associations, technical societies, professional groups, and consumer organizations; some 2,000 companies are affiliated with the institute. Any person or group can propose a standard, and the ANSI provides the machinery to refine it, obtain agreement from as many interested groups as possible, and promulgate the final standard. Nearly 3,000 standards have been approved, in a wide variety of fields. In turn, ANSI is the U.S. member of the International Organization for Standardization (IOS), and other international groups, thus bringing U.S. practice to bear in the setting of international standards.

The committee of most interest to information scientists and librarians is designated Z39. Its charge is all areas susceptible to standardization in libraries, in documentation or information science, and in publishing practices related to these areas.

A few of the subcommittees of Z39 whose work is especially pertinent are: Machine Input Records; Periodical Title Abbreviations; Bibliographic References; Transliteration; Abstracts; Standard Book Numbering; and Standard Serial Coding. Eight new subcommittees are in the process of organization, of which these may be mentioned: Scientific and Technical Report Format; Thesaurus Rules and Conventions; Preparation of Scientific Papers; Codes for Countries, Languages, Publishers, Areas, and Dates; and Identification Code for Libraries.

One of the most important of the subcommittees is Machine Input Records, as can be seen by the titles of two of their standards: *Format for Bibliographic Information Interchange on Magnetic Tape*, and *The Identification of Data Elements in Bibliographic Records*. Next on the agenda is a standard for filing by machine.

At a recent meeting in Stockholm, the IOS established a working group to develop standards for the machine handling of data. Also at that meeting it was decided that Great Britain would coordinate the standard book numbering codes, with the existing U.S. and British codes extended by one digit at the beginning to identify the group, language, etc. This will be the basis for the International Standard Book Numbering (ISBN) codes.

A half-century of careful work has proved the value of the basic philosophy of the institute: all standards are initiated and reviewed in a democratic way and, once approved, there is no official pressure to adhere to the standards. Progress under such a scheme is very slow. Could some way be devised which would retain the voluntary nature of ANSI's program, and yet encourage more groups to adopt the standards?

In their new headquarters at 1430 Broadway, New York, N.Y. 10018, the institute is ready to launch a new program. The plan is to begin the certification of those products whose makers choose to adhere to the approved standards. After passing tests administered independently, ANSI will allow the use of its license mark on the product.

ANSI has made its mark. Look for it.

—WM. R. ESHELMAN, EDITOR  
*Wilson Library Bulletin*

# AN OVERVIEW OF LIBRARY SYSTEMS AND AUTOMATION

behind the stacks

by Barbara Evans Markuson

Several papers in this issue of *DATAMATION* will discuss in detail specific computer applications in the library and information field. This article will concentrate on the library as part of a larger network and as a system of complex, interrelated functions. The aim is to give the reader some insight into the peculiarities of library operation. This background should aid those unfamiliar with libraries to evaluate more realistically the degree of automation that has been accomplished and to appreciate the enormous amount of work that remains to be done before the potential of the computer is fully realized in libraries.

The over-all problems will be simplified in order to highlight those characteristics that present hurdles for the system analyst and make library automation a challenging intellectual task. The reader is urged to examine the list of basic books and articles at the end of the paper for more detailed presentations of specific problem areas. There is an additional caveat—in this paper libraries will largely be treated as if all members of the species were identical. Obviously the Library of Congress, a school library, and a small college library present different design problems; my justification for lumping them all together is that differences are often of degree rather than kind—and a more detailed treatment would require more patience than most readers seeking a general grasp of the situation would have.

Although some libraries have utilized punched card equipment for decades, only recently has there been a

general realization of the impact that data processing devices could have on the library. Partly this was because early equipment was really unsuited for library use and partly it was due to some misunderstanding, in which librarians were not alone, about the extent to which the



Mrs. Markuson was responsible for the early planning and systems analysis of the automation program at the Library of Congress and also participated in the preliminary planning of the MARC project. She has a BA in mathematics and philosophy from the University of Omaha, a master's degree in library science from the University of Texas, and is now working on a PhD at the University of Chicago.

*Although libraries are not yet using computers on the scale of many industrial and commercial organizations, librarians are quite aware of their potential value. In this issue several authors with a combination of data processing and library experience consider some aspects of this intriguing*

computer could perform operations that humans had been performing. Therefore, 10 to 15 years ago proponents of the computer as a useful library tool were prophets without honor; nowadays one can hardly throw a stone at any gathering of librarians without hitting someone who is planning, programming, or operating some kind of computer-based system. To be quite honest, the current odds are probably 100 to 1 that the stone will strike a planner rather than an operator; but, nevertheless, progress has been made.

To many the progress has not seemed impressive and libraries have had some pretty strong critics over the past few years. The assumption has been that the computer forced a conservative, passive, and cloistered profession into the twentieth century. This assumption, though attractive as a dramatic image, is greatly oversimplified. What happened to librarians is no different from what happened to mathematicians, economists, or business managers—the computer provided new opportunities for fast, reliable, and relatively inexpensive data manipulation and opened the door for new services and methods. There is really nothing new in the *applications* themselves. The problems of bibliographic control, standardization, interlibrary cooperation, data interchange, file maintenance, and the need for improved statistical data for decision making have been discussed in the library literature for decades. It is interesting to note, for example, that the first proposal for a centralized national data base for cataloging was made by the librarian

*application area—ranging from problems and prospects to some novel specialized indexing and retrieval systems. First, Barbara Evans Markuson explains the function of libraries in relation to our general information network.*

of the Smithsonian Institution in 1852. The current efforts in this direction differ primarily from his proposal in that computer technology, rather than printing technology, is used.

From time to time, people in the computer industry have expressed surprise at the reluctance of librarians to transfer all of their operations to computer control. At library meetings computer programmers, analysts, and salesmen have frequently stated that solutions have been found and that librarians are either too conventional to adopt them or too insecure to give up their jobs to those who could perform them better. However, once they have been exposed in depth to analysis and design of library systems, computer people tend to take a more cautious view about the extent and nature of computer systems for libraries.

Part of the lack of understanding about how libraries really operate stems from the fact that, until quite recently, only librarians were very much concerned about internal library procedures. To the average person the library was simply a place where one hoped to find needed materials and check them out quickly with as little interference as possible from the staff. From these encounters with only a small part of the total library operation, the ordinary person gained an understanding of libraries about on a par with his knowledge of heart transplants and laser technology.

If a user really wanted to penetrate further into the mysteries of librarianship, the going was rough. Most books and articles on the subject were written by librarians for



librarians. The familiar problem of professional jargon arose and, to the uninitiated, much of the detail seemed trivial and dull. One of the major benefits gained from attempts to utilize the computer is the increasing need for librarians to communicate with other professional groups about library matters and this interchange is occurring more frequently at a detailed rather than superficial level. This communication is essential to improved library systems in a dynamic society. Just as the computer's central data store is vital to the data processing system, libraries are essential to society as the data store of its record of past research, thought, and activity, and all professions should be concerned that only skilled practitioners operate on this social brain.

### the national library network

While each librarian is free, within the constraints of his own organizational setting, to manage a library as he thinks best, there are tremendous forces that operate to keep him from venturing too far afield in trying novel approaches and untested methods. Each library is part of a largely informal national network of libraries on which it is dependent for many services. These services include exchange of catalog data, interlibrary loan of needed books and other materials, aid in reference inquiries, and creation of union lists of holdings<sup>1</sup> to promote better utilization of resources and to prevent unnecessary duplication of infrequently used materials. (Recent studies, such as those being conducted on libraries in the Dallas area by the Industrial Information Service at the Southern Methodist University Library, have begun to plot and measure, with the aid of computer techniques, the degree of dependency of various types of libraries in the local network. Their findings indicate, for example, that business and industrial libraries are highly dependent on the network whereas large research and public libraries tend to contribute more to the network than they receive from it.<sup>2</sup>)

One of the compelling features of American library development has been the strong conviction, from its earliest beginnings, that librarians would have to cooperate to provide adequate service in a country undergoing rapid growth and encompassing a large geographic area. As a result, there is a long-standing tradition of cooperation and standardization and a strong belief that the field advances as a whole—that is, major changes are made only when a significant number of librarians are ready to accept them and to deal with them on the basis of the network of libraries rather than in terms of the individual library alone.

The "network force" has operated most clearly in the automation of cataloging operations. One of the most important achievements in U.S. library history was the early effort to standardize catalog card records so that, theoretically at least, each book could be cataloged only once for the entire country with distribution of the data from a central agency to all libraries. Although this goal has still not been completely attained, the tremendous growth, uniformity, and general high quality of U.S. libraries stem largely from this concept. Beginning in 1901, the Library of Congress (LC) began to distribute its catalog cards to other libraries. The subsequent impact of this service is almost incalculable in terms of man-hours of labor saved. At the present time LC catalog data are transmitted in a variety of

ways: through distribution of individually ordered cards (about 63 million in 1968), through the printed *National Union Catalog*, through subscriptions to catalog copy on proofslips and cards, and through various bibliographic and book trade tools. Since April, 1969, catalog data for current books in the English language are also available on magnetic tapes (the MARC program) distributed weekly by the Library of Congress to more than 90 subscribers.

The dependence of a large percentage of U.S. libraries on this centralized source of cataloging acted as a brake on attempts to automate local catalog operations during the past decade. The problem was that if a library struck out on its own it would probably end up with a nonstandard catalog data base. There was also the strong feeling that, if the past was any guide to the future, sooner or later the Library of Congress and other major public and research libraries would develop a standard format for machine-readable catalog data. It was also equally clear that the development of a format that would meet the needs of a majority of U.S. libraries could not be done overnight. Preliminary plans and investigations for a MARC (Machine-Readable Cataloging) format began in 1964 and 1965; an initial format was developed and tested in several libraries from 1966 to 1968; and a final format was agreed upon by U.S. libraries (and major British library agencies) in 1969.

The result of this work is a general format capable of handling all bibliographic records and flexible enough to allow a variety of local applications on a wide range of hardware configurations. It is also designed so that, insofar as possible, data can be easily manipulated by both character and word machines and by different programming languages. The over-all format is consonant with the standards for telecommunication of data set by the United States of America Standards Institute. In addition to setting the over-all format structure, the format was worked out in detail for catalog records of book materials.

At the present time, work is under way to develop the specific details for recording catalog data for serials (including journals, newspapers, and government documents). A preliminary format for serials has been developed by the Library of Congress working in conjunction with the National Agricultural Library, the National Library of Medicine and other library and information groups. The preliminary format has been distributed for study and comment and a final format will be announced only after analysis of the comments and trial tests under actual working conditions.

More than any other segment of the information community, librarians are aware of the ultimate high cost of non-standard practices and they tend to work first for agreement on codes, data fields, and definitions before embarking on large-scale projects. This approach can be compared to the work being done to develop urban data bases, information systems for professional associations, and abstracting and indexing services where little concerted effort has been directed to standardization, with the result that data cannot be easily interchanged among interested groups. The importance of communication standards for an individual library may be illustrated by the fact that it can in the future receive catalog data in the MARC format from the Library of Congress, from its state library, and from local libraries in its area and assimilate them into its own operations by writing one set of computer programs. Without the standard, the library might have to cope with dozens of formats and a chaotic and prohibitively expensive operation.

There are, however, some aspects of the individual li-

<sup>1</sup> A union list is a catalog, for example in a central city library, that shows which books are in each branch, as well as those in the main library.

<sup>2</sup> Duggan, Maryann: "Library network analysis and planning (LIB-NAT)," *Journal of Library Automation*, 2 (Sept. 1969), 157-175.

library system that do not have much relationship to the overall network. These operations include local housekeeping such as acquisition of materials, fund accounting, generation of lists of local holdings of certain materials, and circulation (control of materials on loan, borrower registrations, etc.). For this reason, most current automated systems fall into these categories since decisions at the network level would be less likely to force changes.

#### automation—now or later?

Discussions used to center around *whether* to use the computer. Now it is largely a question of *when*, and almost every library administrator has had to come up with a position and a timetable that he can justify. Richard De Gennaro in a recent paper<sup>3</sup> has characterized three types of administrative response: (1) the wait-for-developments approach, (2) the direct approach to a total system, and (3) the evolutionary approach to a total system. Each position may be reasonable, depending on the situation in a given library.

The first approach is "based on the premise that practically all computer-based systems are in an experimental or research and development stage with questionable economic justification, and that it is unnecessary and uneconomical for every library to undertake difficult and costly development work. The advocates of this approach suggest that library automation should not be a moon race . . ."

The direct, total system approach considers the library as a series of interlocking operations which should be analyzed thoroughly as a total system before implementation of any part is undertaken. This approach "does not require that the entire system be designed and implemented at the same time, but permits treating each task as one of a series of modules, each of which can be implemented separately, though designed as part of a whole." This approach is the most complex, and the total system is generally based on the use of more sophisticated equipment including on-line terminals.

The last approach is the time-honored tentative foot-in-the-door technique. "The library moves from traditional manual systems to increasingly complex machine systems in successive stages to achieve a total system with the least expenditure of effort and money and with the least disruption of current operations and services." This has been the most common administrative response to the computer and it ordinarily involves the library in the development, largely with in-house staff, of some automated system such as circulation control to supersede its existing operation and then moving on, as staff and funds permit, to another area. De Gennaro points out that these operational systems will have to be redesigned when more sophisticated systems are warranted, but that the accumulation of firm statistical data from the on-going operations should be a great advantage for the designers of the second-generation library system.

An administrator's position could be influenced in part by the complexity of his particular node in the library network. The degree of centralization and the geographic dispersion of his operational units are important factors. Larger public libraries, for example, have dozens of branches and book outlets. Some county libraries, particularly in the western states, cover hundreds of square miles. Broadly speaking, branches of public library systems are generally subsets of

the main collection, making centralized processing efficient, but presenting logistical and communication requirements that complicate the design of satisfactory computer-based systems. Larger university libraries are decentralized through special departmental libraries and other collections. These collections are not generally subsets of the main library; they are unique materials organized to provide specialized reference service and to minimize geographical barriers to use.

These factors, and some others that will be discussed later, influence the administrator's decision. In general, one must know quite a lot about the local situation before reaching hasty conclusions about what a given library should be doing about automation.

#### the library in its institutional setting

A library can be considered as being embedded in a matrix that tends to restrict its degrees of freedom in implementing automated systems (or making other changes, for that matter). The most important elements in the matrix are:

1. The library network
2. The parent institution
3. Its user group
4. Its history

The restraints imposed by the library network have already been discussed; attention now shifts to the local situation.

*The parent institution.* Libraries, almost without exception, are part of some larger organizational unit such as a city, county, or state government, a college or university, or a business enterprise. The long-range plans of the parent institution must be considered in planning for library programs and services.

The system designer must study the interchange between particular library operations and other systems in the larger organization. The parent institution makes decisions that serve the organization at large and these may sometimes hamper the administration of the library. For example, one of the common problems of automation of circulation systems in academic institutions has been the degree of involvement of this operation with the registrar, the bursar, etc. In some instances, the issuance of a machine-readable identification badge has created difficulties since the institution wants one badge to serve many purposes—the library would like the student to retain his badge throughout his stay whereas the athletic department wants it renewed frequently to ensure payment of admissions fees, etc. Another frequent source of difficulty stems from budget cycles and purchasing routines; the nature of purchasing library materials is so different from buying hundreds of pencils from the lowest bidder that even simple purchases may be made complex if the institution insists on bid procedures and complicated payment forms.

The decisions that may most directly affect library automation are the policies relating to acquisition and management of data processing equipment. In general, the library has too little clout in the power structure to influence either the choice or utilization of computer. I know of instances where a library system in a large metropolitan county has to use a computer far too sophisticated for its needs and pay high hourly rates for its processing and output printing while an information service in a national association has to use a small computer totally insufficient for its needs. It is not unusual for a library to develop a good system only to have top-level administration decide to change computers and leave the library high and dry with a lot of expensive, unusable programs. Unfortunately, very few libraries can

<sup>3</sup> De Gennaro, Richard: "The development and administration of automated systems in academic libraries," *Journal of Library Automation*, 1 (March, 1968), 75-91. The quotations in the next paragraph are taken from pages 77 to 79.

justify the installation of a separate computer since the very large storage requirement is not matched with a constant processing load heavy enough to keep third-generation equipment fully occupied.

The management may set policies about closed-shop programming and machine schedules that make it difficult for the library to automate. More than one installation has been justified on the benefits to the library, but often when the computer is installed and it is discovered that library operations require definite daily access to the computer the library's machine priority slips lower and lower. There have also been cases where agitation for library automation has stemmed from administrators, faculty, or user groups who have read in the press about marvelous push-button information retrieval systems. Even if the local equipment could not possibly support this type of application, it takes a strong library staff to withstand the pressure.

Many libraries have excellent working relations with their computer center staff and where this spirit of cooperation exists quite good results can be obtained even under less than ideal situations. Perhaps the most important thing for the computer center staff to understand is that automation has brought about the first instance in library history in which the librarian has had to go through an intermediary to get at his own data. Since the library is almost totally a file-centered operation, the ultimate implications of this situation are not yet clearly understood. It is rather like a library operating with its card catalog in another building where the janitor locks the door when he feels like it and turns the lights on and off at will. Nothing causes quite as much turmoil in the library field as fear of destruction of the central file—as a matter of fact it is easier to replace the collection itself than the file. (Witness the fact that the recent onslaughts of student radicals on the university library have compelled many administrators to microfilm the card catalogs and I was told recently that quite a run on film has resulted from this situation.)

The librarian has an obligation to his institution that goes beyond the daily services provided. A good library represents a large investment of institutional resources over a long period of time. The librarians' conservatism may be regarded as just that, or it may be viewed as an appropriate mechanism to ensure that this investment (amounting to hundreds of millions of dollars in a large research library) is not squandered by attempting to incorporate every new scheme and device that is announced.

Due to the extremely large number of variables in each library operation, it is difficult to make realistic experiments that will accurately predict the success or failure or, even more important, the long range implications of changes. It is also difficult to assimilate the results of much of the current information research since these projects are often highly artificial systems restricted to small, homogeneous data bases handling "canned" queries. No librarian is able to experiment with the total system in the decision-making process.

In fact, since many libraries do not have research and development budgets, it may be difficult even to run pilot systems for sufficient periods of time. Recently some librarians have been successful in convincing their administrators that research and development is an appropriate library activity, but by and large only the largest libraries have adequate staffs for this work (the New York Public Library and the Library of Congress, for example, each have large systems staffs including librarians, computer analysts, programmers, and research assistants). For the library administrator, decision making with respect to li-

brary automation is fraught with difficulties. Only one certainty exists. Whatever the set of circumstances that might lead to a library's embarking on an automation project, if it is of significant size and it fails, it is the head librarian who will be shot out of the saddle—the systems analysts and programmers will already be on the first stage headed for the next territory.

*The user.* The library has traditionally been a service-oriented institution and librarians try hard to meet user needs within the operational and budget constraints placed on them. This service orientation provides one of the most interesting challenges in system design.

Since one rarely gets to design a system for a new library, the analyst is generally faced with an on-going operation which must continue to function during all conversion and change-over periods. One simply cannot remove the public card catalog for several weeks for tagging and keyboarding. Effective management of transitional operations must be carefully planned if the users and staff are not to be thrown into a chaotic state that will only give them a deep aversion to automation.

Furthermore, the new system will immediately come under the scrutiny of patrons who will measure it by only one standard—its usefulness to them. In automation of industrial or business operations, most of the direct users of the system can be given orientation sessions that will help condition them to be tolerant of difficulties that may arise in a shakedown period. Libraries generally cannot afford to do too much along this line, especially when they have thousands of users. The average user will not be impressed with the useful statistical, file maintenance, and management by-products of the automated system if it impedes his straightforward use of the library. If he has been conditioned to use the card catalog, he may not like the computer-produced book catalog; if the librarian cannot consult a card file and tell him immediately how many books he has charged out, he may feel that the new batched-process circulation system is a backward step.

To date, the majority of automated library operations involve files that are accessed only by the library staff—e.g., acquisition and circulation files. However, the primary bibliographic information files such as the card catalog have always been available to any user. The service orientation of the library has been posited on the assumption that, within reasonable limits, any user has the right to station himself at the catalog and use it for as long a period and as frequently as he desires. In addition, if the user does not ask for help in formulating his search strategies, he is free to use the catalogs without any intervention by the librarian. There is, of course, a rationale behind this tradition because most libraries could never afford to provide an individualized searching service for all users and the specialized information centers can only do so because of the limited nature of the subject areas they cover and the relatively small number of users.

For years, the *gurus* in the information and computer fields have foreseen the day when users will directly access vast files of machine-readable data not only in their local library but, through telecommunications channels, in other libraries in the national network. There is no reason to believe that this day will not come eventually, although its dawning is already behind some of the early predictions. The system implications are not trivial. The design of the terminals and file access techniques suitable for use by the untrained public (and by and large most users do not want to be bothered with instructions even for manual files) and the potentially severe queuing problems<sup>4</sup> when both users

and staff are competing for use of the same central files are only the most obvious difficulties. Even this brief summary, which has neglected the complexity of the central files and the search strategies, indicates that the nature of the problem is different from an application such as an on-line airline reservation system where terminals are used by trained staff, require a limited instruction set, and are not available for use by the general public.

*Past decisions.* Since most library systems analysts are equipped with 20/20 hindsight, it will be immediately obvious to them that some practices in a given library are inefficient or outmoded. Frustration may result if the library management chooses to retain these practices in the new system. The situation arises largely because the library is a cumulative, growing organism and it has either to live with its past or spend large sums of money and a lot of time on the analyst's couch and in subsequent rehabilitation sessions to exorcise its ghosts.

If the catalog or serial record file is not all it should be, the updating of hundreds of thousands of records, although desirable, may not be economically feasible. Some changes would involve more than addition or revision of data fields, due to the highly interrelated nature of the central files and the materials stored on the shelves. Some changes of the data would also involve changes on the documents themselves (for example, assigning a unique numerical identification code to each item) and such changes are time consuming, expensive, and tend to disrupt on-going operations. The librarian faced with such a situation must decide whether to adopt a new system entirely, close out the old and begin the new system with current input, or retain the old practices. The decision to set up a dual file is not taken lightly because, in most libraries, contrary to what one hears about the immediate obsolescence of printed data, these dual files will continue to be accessed for many years.

### **the library as a system**

When a researcher submits a request to the library for the purchase of a copy of an investigation of sampling techniques for tuna and marlin population in the South Pacific published by some obscure Japanese fisheries experiment station, he exhibits very little interest in what happens in the interval between the arrival of his usually imprecise bibliographic description in the library and the addition of the report to the collection.

For the library, processing this request will set in motion a chain of routine, but complex and interrelated, operations. Searching must be performed to complete the bibliographic data and to ensure that the report is not already somewhere in the system, order forms must be prepared, funds encumbered, and a decision must be made about the most efficient method and source for document procurement. When the report is received it must be checked against the order to guarantee that the right document was sent, Japanese currency must be converted to U.S. monies to set payment in motion, invoices and funds must be cleared and order files updated. Catalogers must determine availability of catalog data from LC or some other source and, if it is not to be had, original cataloging including subject analysis and classification must be done. Cards are prepared and filed in the proper catalogs and the report must be processed for circu-

lation. At some stage in the cycle, notification of availability of the document must be sent to the original requester. Throughout this entire cycle controls must be set up to ensure that this order will not be confused with any other and that, in the future, the report can be retrieved on demand from storage.

The individual nature of the units to be handled, and an inability to predict the bibliographical and physical complexities that processing might involve, make it impossible to obtain precise data on work flow rates and unit process times. The number of paths that an item may take in the processing stream varies depending on its language, subject, physical condition, the availability of cataloging data, and work queues at various stages.

While it is true that most books move through essentially the same stages in being processed, attempts to make this an assembly-line operation are largely fruitless for the reasons cited above. Therefore the time and cost figures that an analyst normally needs in system design are largely nonexistent or are simply derived from average cases. This lack of data makes it hard to project requirements and to estimate the degree of improvement that an automated system would have over the manual operation. In many cases data could be captured but the analysis would require enormous expenditures of money and effort.<sup>5</sup> In fact, one of the major benefits that automation will have for libraries is in the area of operational and performance statistics, although even in an automated library much of the really important data cannot be derived from simple operational analysis. The lack of hard data requires the analyst to rely on the judgment and intuition of experienced librarians in analyzing the present operation and assessing new approaches.

In analyzing operations in libraries, four major flows must be considered: the sequence of operations being performed, the operational and instructional data flow, the flow of bibliographic information, and the material being processed.

For example, when a book moves through the processing cycle, operations are usually, but not always, performed in a set order—searching, order preparation, cataloging, etc. The book may be accompanied by special handling instructions (these might refer to its priority in the various queues, its distribution after processing, or its cataloging treatment), but if no special instructions are given, members of the staff generate them intuitively on the basis of the item's similarity to previously handled material and general instruction manuals and policies. As the book flows through the cycle, a bibliographic record is being created that will eventually end up in the card catalog, a magnetic tape, or some other permanent file. In a small library these records might be created by one person, but in a larger system the work might be broken down functionally so that some people do preliminary cataloging and searching, others do descriptive cataloging, others subject analysis and so on.

Through all of these processes the book itself must be

---

<sup>4</sup> In a sample taken at the Library of Congress, as many as 638 different people accessed the central catalog files during an hour. It was impossible, under the conditions set up for this sample, to even estimate the number of queries each person made or the number of minutes he was actually using the file during the hour.

---

<sup>5</sup> At a recent meeting an operations research analyst stated that librarians as a group had very little hard data with which to measure performance. In particular he reported that a large public library system that he was working with could only give him circulation statistics relating to items borrowed and could not tell him what was borrowed, the characteristics of the borrower, what his information needs were for each library use, and whether the borrowed item actually was useful in fulfilling those needs. This information was, according to him, vital in planning new library locations and services and measuring the performance of the library in providing existing services. I am sympathetic to his views, but before attending the meeting I had read the latest annual report of the library in question. It had circulated almost 4 million items in the previous year!

forwarded from operation to operation. In an automated system the materials handling cannot be ignored because it is the basic library operation. If the automated system is a batch processing operation, the results of the batch must often be matched with the proper item. For example, if a catalog record is printed out from the weekly LC MARC tape it must be matched with the appropriate book in the catalog department. If book labels are produced in batches on the line printer, they must be affixed to the proper book. In manual systems these problems are often not recognized because the records usually accompany the book itself until processing is completed. But in most automated systems the book and record usually become separated at some stages. These difficulties may be partially overcome in on-line systems, but only if the terminal devices are equipped to provide the required output (e.g., cards, labels, routing slips, etc.) on the spot.

### the nature of library files

The library is almost totally a file-centered system. Basically, the primary difference between a library and a book store is that the library organizes the books and relates them to one another. This organization is accomplished through the structure of, and records in, various catalogs and files. The books themselves do not necessarily have to be organized and, although it is the general practice in U.S. libraries to classify books on the shelves, some libraries merely shelve books in order of their acquisition.

The library, like the law, is based on precedent. In order to bring out the relationship between books one must check the files. Are there other books by this author? Other editions of this book? Other books on this subject? Through answering these and other questions, each new book entering the system takes its place in the bibliographic spectrum.

In almost every operation, save purely physical tasks such as pasting and shelving, access to one or more files is required. In the manual system each operation may have its own set of files organized in the manner that best suits the task at hand and located to minimize walking to and from the file. The average library would have several files, including outstanding orders, the serial record file, loan files, bindery files, and the central catalog file complex. This last set of files generally consists of catalog cards in two broad arrangements: alphabetical and call number order (forming a shelflist or inventory of the items as they are arranged in the collection). The alphabetical file may be broken down into separate files. The most common arrangements are: (1) a dictionary catalog with all names, titles, and subject headings interfiled in one alphabet, and (2) a divided catalog with names and titles in one file and subject headings in another. Several other variations are possible, but the whole set of catalog files may be thought of as inverted indexes all created from a common data base to allow certain access points to the record.

In some of the early library systems analysis, it was commonly held that data from all of these diverse files could be integrated in a master record bringing together all the bibliographic, acquisition, circulation, and other data about each item. This approach had wide appeal because analysis showed that there was much duplication of data between files and experience showed that files were expensive to maintain. As the nature of the automated library system becomes a little clearer, questions are now being raised about the feasibility of this approach. For one thing, the data in some files are of temporary value, and some data, for example in order files, may not be as accurate as catalog data since the records are created before the book itself is

seen. Entering all these data at acquisition time may mean that an enormous amount of field correction and revision may have to take place in the central data record. In addition, the centralization of data into the central files may further complicate the queuing and search problems mentioned before.

Whatever the final solution is, one thing is clear—the file(s) will not be simple. The library collection might include books, journals, newspapers, microfilm, phonograph records, maps, slides, movie films, government documents, and technical reports. Data records will reflect the varying nature of the input and the file structure will reflect the interrelationship between the items in the collection and the subjects they cover. In addition, a high degree of accuracy must be maintained, because an inaccurately recorded or misfiled item is, to all intents and purposes, lost in the system. Each data record must contain enough discriminators to describe the item and to distinguish it precisely from all other items in the collection.

Library data records in general have the following features:

1. Variable length.
2. Relatively large—i.e., records of several hundred characters would not be unusual.
3. Include both variable and fixed fields.
4. Include alphabetic and numeric data.
5. Include English and foreign languages.
6. Roman and non-Roman alphabets.
7. Coded as well as uncoded data.

Another common characteristic of library records is that while many different fields must be defined to cover all the items in the collection, any given record will contain only a subset of the possible fields. This means that an analyst developing a format generally has to take a fairly extensive sample from the file before he can be sure that he has seen most of the data fields required to describe the input. For example, the LC MARC format was based on a random sample of 2,524 catalog cards as well as a number of special analyses of certain data elements and the trial format was exercised on 50,000 titles in the pilot project before the final format was developed. The complexity of certain data records may be illustrated by the preliminary MARC format for serials which includes 80 tags for different variable fields, some of which are further subdivided by subfield codes; 22 fixed information fields, 9 control field tags, and a 23-character leader to take care of the housekeeping details concerning the record itself.

Unfortunately, once the data are in the files the work is not necessarily done. The library deals with a changing world and this is reflected in continual file maintenance activity. In fact, this activity is so burdensome that it is probably the most neglected operation in the manual system. Maintenance results from name changes (e.g., the American Documentation Institute became the American Society for Information Science); from title changes (the *American Library Annual* became the *American Library and Book Trade Annual*); from reclassification, as new relationships among subjects are developed; from changes in existing subject terminology or the introduction of new subject headings (the space program would generate many new subject headings); and from many other bibliographic situations. In addition to these substantive changes, there is also the normal file maintenance resulting from error correction, purging, and insertion of new records.

The organization of these records into file structures for ease of maintenance and retrieval access remains a crucial problem of library automation. Most on-line library systems



have fewer than 100,000 entries, whereas many library systems have hundreds of thousands of records and most large university libraries would have catalog files alone amounting to millions of records. These files are rarely purged and grow at a rate generally assumed to amount to a doubling every 10 to 15 years. The files are also highly skewed so that, for example, in a subject index, many headings might have few postings while others, such as "U.S. Civil War—History" or "Economics," might have hundreds of postings.

One of the complaints about manual catalogs is that they provide only a limited capability to access file data. Only a few search entries are allowed for each book, usually the author(s), title, an average of about one and a half subjects, and a classification number. It is assumed that having data in machine-readable form will permit access on other important elements such as subtitles, publisher, date, and country of publication and that it may be possible to input many more subject terms. Although librarians hope that this will be the case, too little work has been done to permit an assessment of the actual validity of this assumption. If the data base is too large to search even in random access storage without an indexing structure, it cannot be assumed that digital indexes of the size required will not be expensive to construct and maintain.

Although some libraries have set up secondary storage warehouses for books that are infrequently used, few have partitioned their files on frequency of access. It would be difficult to do so because, while one can use circulation records as indicators of a book's popularity, there are no records of file use. It might be argued that if a book is not used its records are not used, but this is not necessarily so. A library catalog can often be used as a tool itself without reference to document retrieval at all. Such uses occur for acquisition searching, for verification of authors' names, for answering reference inquiries about holdings, or for surveying a library's collections in some area.

### output printing requirements

Printing requirements fall into two broad categories: the display requirements and the character set needed. One of the early assumptions about library automation was that once data were stored in digital form the library would be freed of its complex filing (sorting) problems. This assumption is valid if one postulates a totally on-line system, but it begins to break down if data are going to be printed out in catalogs, bibliographies, reading lists, etc. Filing is essentially a display problem and there are, unfortunately, no simple solutions to the organization and array of complex entries and records. The sorts that will be needed are more sophisticated than simple alphabetical arrangements and vastly different from the collating sequence of any computer. The reader who wants to get an insight into the problem should read "The MARC Sort Program"<sup>6</sup> which reviews the capabilities of a program developed to handle some of the problems that arise in MARC data records, but which, according to the authors, will have to have additional refinements in order to handle certain complicated fields properly.

In addition to the arrangement of the entries in proper bibliographic sequence, the layout of the data on the page or form is important. The analyst should attempt to achieve the most satisfactory trade-off possible between economy in terms of number of pages and legibility for ease of scanning. A total system might include printing of order forms, lists of

new books, overdue notices to borrowers, catalog cards, book catalogs, special bibliographies, search results, selective dissemination notices, and management reports.

If the total system is to include foreign language materials, then it is clear that the normal print train will not suffice. As a result of the MARC project, a library print train has been developed which has 166 characters and is sufficient for almost all characters occurring in Roman alphabet languages. For a discussion of character sets and print trains, the reader should see item five in the appended bibliography. An exhaustive review of the special problems presented by Roman alphabet languages is presented in the paper "Special Characters and Diacritical Marks Used in Roman Alphabets."<sup>7</sup> The problem of handling non-Roman alphabets such as Cyrillic, Japanese, and Chinese can probably only be solved with crt-type printing devices.

The reader might well wonder why libraries cannot get around this problem by either translating or transliterating the data records. Translation would be entirely unsatisfactory for bibliographic control, because language is imprecise; several people might translate a title differently and there would be no way of knowing that three different English titles all referred to the same Russian work. Translation would, of course, be a step backwards in terms of international bibliographic control and exchange of data. Transliteration presents essentially the same problem—precision of identification of the bibliographic item is impaired. Since transliteration is the writing of one language in the alphabet of another, most transliteration schemes attempt to use letters that will approximate the sound, when possible, of the language being translated. For this reason, a German transliteration of a Russian title will not be the same as an English transliteration even though both use a Roman alphabet. For filing purposes, most libraries have to transliterate headings so that all entries can be handled in one alphabet, but tampering with the rest of the record creates bibliographic problems and complicates use of the file by language experts. (A librarian visiting Russian libraries told me that it was all but impossible to scan the catalogs for English literature because all the titles had been transliterated into Russian and he had to retransliterate them to recognize well-known names.)

In comparison with those of most computer users, the library printing requirements are fairly demanding, even if the problem is not complicated with foreign alphabets. Most products are not temporary, throw-away listings, but will be used by many people over fairly long time periods. Some computer centers find it difficult to adjust to these demands for quality printing. For example, satisfactory printing of catalog cards requires accurate placement of the stock in the feeder and proper alignment of the printer if the tolerances for placement of data are to be met—i.e., no printing over the hole at the bottom of the card and no data lost after the stock is fed through a trimmer. With careful attention to physical details, use of high-quality ribbon and clean type, the computer line printer can produce output that meets most library requirements for legibility and esthetics, particularly if an upper-and-lower-case print train is used.

An acquaintance of mine who has been involved in many conferences and gatherings of poets told me that one can always spot the amateurs because they talk about imagery, meaning, symbolism, and other esoteric topics while the

<sup>6</sup> Rather, John C. and Jerry G. Pennington: "The MARC Sort Program," *Journal of Library Automation*, 2 (Sept. 1969), 125-138.

<sup>7</sup> Rather, Lucia J.: "Special characters and diacritical marks used in Roman alphabets," *Library Resources and Technical Services*, 12 (Summer, 1968): 285-295.

professionals talk about money. In some ways the topic of information retrieval is the imagery and esoterica of information science—it is discussed far more by mathematicians, physicists, and linguists than by the librarians. Although it is the core of the library operation, librarians as a whole are not yet sure whether, even with the computer, they can provide extremely sophisticated search strategies for large data bases. In particular, they do not put too much faith in search of natural language data without intervening structures such as thesauri or subject headings to remove some of the ambiguities of language—especially when their collections include foreign materials. And few librarians would give any credence to those who talk about full digital storage of text when at this point in time the storage requirements for catalog files alone cannot be provided economically for the large research library.

For the librarian, information retrieval is an operation that must be considered as a part of the total library system and not as a separate, isolated topic. Data cannot be retrieved until it has been coded, converted, and stored and only now is the library community beginning to tackle the problems of converting large files of bibliographic records. Many of the laboratory retrieval systems may have applications for specialized libraries or for special collections or services in the large research libraries and they are therefore of interest to the library community. However, the general feeling is that the computer should first be used to improve present levels of library service and, when that goal is attained, more sophisticated retrieval techniques will be studied for their general applicability to library systems.

#### future developments

The librarian is faced with a wide range of new devices that may be incorporated into the library system. These include facsimile transmission, telecommunication equipment, digitalized microform systems, mark-sensing devices, etc. Each of these devices, along with the computer, may play a role in the automated library system. It may be necessary for libraries to pool their resources in local and state systems to be able to afford some of this equipment. Many state libraries are beginning to develop plans for state-wide systems that will link libraries together in a number of channels ranging from the U.S. mail to facsimile, television, and digital communications. Obviously the analysis and design of such systems will be far more complex than anything now being developed.

Librarians have made much progress over the last five years in understanding and utilizing computers. Tremendous effort has been expended in education and training through special courses, conference programs, and workshops. Most library schools now require all graduates to have some familiarity with systems analysis and data processing techniques. Many librarians have become quite expert programmers and have worked closely with local computer staff members in designing systems.

The day is dawning, however, when library automation can no longer remain at the cottage-industry level. The forces of the library network are operating to push developments at a higher level than the single library. Planning and designing state, regional, and national systems will require the skills of experts in many areas. The librarian must continue to keep abreast of general developments to ensure that the system produces better services than are now available and to keep setting goals commensurate with technological progress.

As De Gennaro notes, the real key to development of automated library systems is to get people who are totally

committed to library automation whatever their background. This commitment involves a belief in the library as a vital and essential part of society and a view of the library as an important national resource which should be available to the greatest extent possible to all citizens regardless of their geographic location. The automated national network is a long way from reality, but foundations are now being laid, and if we can reach the moon who knows—they may need a branch library up there some day!

The following reports were prepared by the Information Systems office of the Library of Congress.

*The MARC Pilot Project; final report.* 1968. 183 p. (Available from the Government Printing Office for \$3.50.)

*The MARC II format; a communications format for bibliographic data.* 1968. 167 p. (Available from the Government Printing Office for \$1.50.)

*Serials; a MARC format.* 1969. 72 p. (Distributed by the Information Systems Office, Library of Congress.)

*Annual Review of Information Science and Technology.* Distributed for the American Society for Information Science by the Encyclopaedia Britannica, Inc., Chicago (vols. 1, 2, and 3 (\$15.00 each), vol. 4 (\$16.00).

Reviews developments over the entire range of information activities. The chapters on library automation and library and information center management assess the most important work of the preceding year and include detailed bibliographies.

#### Bibliography

Conference on Libraries and Automation, Airlie Foundation, 1963. *Libraries and automation; proceedings.* Edited by Barbara Evans Markuson. Washington, Library of Congress, 1964. 268 p. (Available from the Government Printing Office, Washington, D.C. 20401 for \$2.75.)

Although this publication is several years old, it still remains one of the best over-all treatments of the basic problems of library automation. Special topics include file organization, printing, and telecommunications.

Cox, N. S. M., J. D. Dews, and J. L. Dolby. *The computer and the library; the role of the computer in the organization and handling of information in libraries.* Hamden, Conn., Archon Books, 1967. 95 p.

An excellently written, cogent introduction to library automation.

*Journal of Library Automation* published by the Information Science and Automation Division of the American Library Association, 50 East Huron St., Chicago, Ill. 60611. Quarterly. \$10 a year to nonmembers.

The primary vehicle for discussions of general topics and descriptions of specific systems. Recent issues have included papers on on-line circulation systems, cost comparison of computer versus manual catalog maintenance, and book catalogs.

King, Gilbert W. and others. *Automation and the Library of Congress.* Washington, Library of Congress, 1963. 88 p. (Available from the Government Printing Office, Washington, D.C. 20401 for \$2.00).

A projection of the requirements for a total automated bibliographic system for the largest library in the world in the 1970's. Includes systems analysis and operational data about various bibliographical operations at LC. ■

# COMPUTER COSTS FOR LARGE LIBRARIES

professors are cheaper

By William N. Locke

The purpose of this paper is to bring to computer professionals a realistic view of what a large library is and what the jobs and costs are which a librarian must worry about. So far computer technology has had only a limited impact on library service because it has not been cost competitive. In a few areas computers can compete. We shall discuss three main topics: books, people, and computers. Let us start with books, including all kinds of library materials.

An outstanding computer engineer recently compared libraries to the New England whaling industry, "a romantic relic of the past," he said. "As whales disappeared, so will books. We should stop building libraries, store all information on tape and retrieve it through consoles."<sup>1</sup>

This may be acceptable as a piece of blueskying but it hardly comes to grips with the problems of today and tomorrow. At a time when the world outpouring of printed words is going up 8%-10% a year (about 450,000 books, 200,000 periodicals and 200,000 technical reports<sup>2</sup> in 1968), it makes little sense to talk in terms of a replacement of print by any other form. Books are the most efficient way to store information ever invented. Libraries are going to be around for a long time. They cost dollars and serve people. To get dollars they have to compete with other goods and services.

One often recommended way of beating the glut of printed matter and rising costs is to cooperate with other libraries so that each can specialize. Librarians all approve

in theory but they don't do it except for materials of vanishingly low use levels. This is because, when someone asks for something, you want to be able to produce it. He wants it now and you know by experience that if he has to get it on interlibrary loan, 50% of the time he will say "forget it." Then you, and to some extent he, feel frustrated. Perhaps with better interlibrary communication networks, remote access to text and new generations of librarians and customers, progress can be made. But to come back to today:

"One of the diseases of this age is the multiplicity of books; they (doth) so overcharge the world that it is not able to digest the abundance of idle material that is every day hatched and brought forth."

This was written by Barnaby Rich in 1613.<sup>3</sup> (*Cont'd.* p. 70)



Dr. Locke has been director of libraries for MIT since 1956. He was previously head of the department of modern languages at the same institution and has also been a professor at Harvard and Radcliffe. He has a BS from Bowdoin College and a PhD from Harvard in romance philology.

This article is based on a paper, "Library Requirements," presented at an SJCC panel, "Computers in Service to Libraries of the Future," Boston, May 15, 1969, whose chairman, Calvin N. Mooers, the author wishes to thank for assistance in its preparation.

<sup>1</sup>Remarks at an MIT seminar in 1965, the author of which would probably rather not be identified.

<sup>2</sup>Extrapolated from published UNESCO figures for books, estimated for journals and technical reports.

<sup>3</sup>Quoted by de Solla Price, Derek, *Little Science, Big Science*, Columbia University Press, 1968, p. 63.

Some people think all we have to do is select books more carefully and libraries can be smaller. That is easier said than done. Quality is relative and time-dependent. So quality selection always has been and always will be a problem. But there is one thing that has changed. That is the scale. Libraries are getting bigger faster. There are more of them all the time. We have a shortage of everything but books. We can't get enough buildings or staff. Costs of libraries are going up 10% a year; other costs, about 5%. This means we have to take a bigger bite each year of total university income. This can't go on. Some people say computers can solve our problems. To see if they can, we will take a look at what librarians do, what those who use libraries do, then where computers fit in. And I remind you that we shall be talking about the real world where you have to fight for every dollar and live within your budget.

**what librarians do**

Librarians like to define a library as "books and people serving people," emphasizing the role of the staff. We are getting away from the old mausoleum library toward the information center concept, though the latter may, at the limit, not even include a library. Some universities have information centers, but in addition to, not instead of, libraries.

There are three main types of libraries: the public library, usually a general collection with emphasis on current publications; the special library, with mostly current material focused on one or more fairly narrow areas of interest; and the academic library, with both current and historical material in all the fields covered by the educational and research programs, plus some coverage of the intellectual life of the world at large.

Thus the academic library has to have both depth and breadth, which explains why Harvard has 8 million volumes and why there are nearly a hundred other universities in this country with over a million. Each of these hundred is buying annually more than 5% of the titles published in the world. Each library with a million titles holds half of 1% of all the titles published since Gutenberg.<sup>4</sup> Harvard's library budget for last year was \$7 million; MIT's was about \$2 million; and last year there were 78<sup>5</sup> academic libraries in the U.S. which spent over a million dollars. This may not sound like much to anyone in business; but if you consider that ours is a service operation where it's all outgo and no income, you can see that we are in a tough spot. I say there is no income. There is, but it differs from ordinary income in that it is not directly related to a product or service. The services we give are almost impossible to measure in dollars, but the costs are all too easy to see.

Let me take MIT as a not untypical example. Years ago it was broadened far beyond science and technology until it has become a medium-sized university. In fact, 44% of our library purchases today are in social sciences and management. Last year we worked out a program budget with two students, Jeffrey Raffel and Robert Shishko, under the direction of Professor Fred C. Ikle. This included amortization of land and buildings. A breakdown of expenditures is shown in Fig. 1.

Administrative costs are prorated among the various items. Of the program budget, 73.7% goes into the general and research collections, 23% into reserve books and asso-

ciated study areas, and 3.3% into research<sup>6</sup>. Starting at about 8 o'clock and going clockwise, we find over a third of the budget (36.4%) going into selection, purchasing, organization and maintenance of the general and research collections. Only a small fraction of the total (6.4%) goes to pay for book storage space. Cataloging (15.6%) provides the organization of the collections. Circulation and reading rooms account for another 11.9%; and information services, which librarians call reference, is only 9.8%. We shall return to these last fractions for storage and for information services and compare these costs with computer costs.

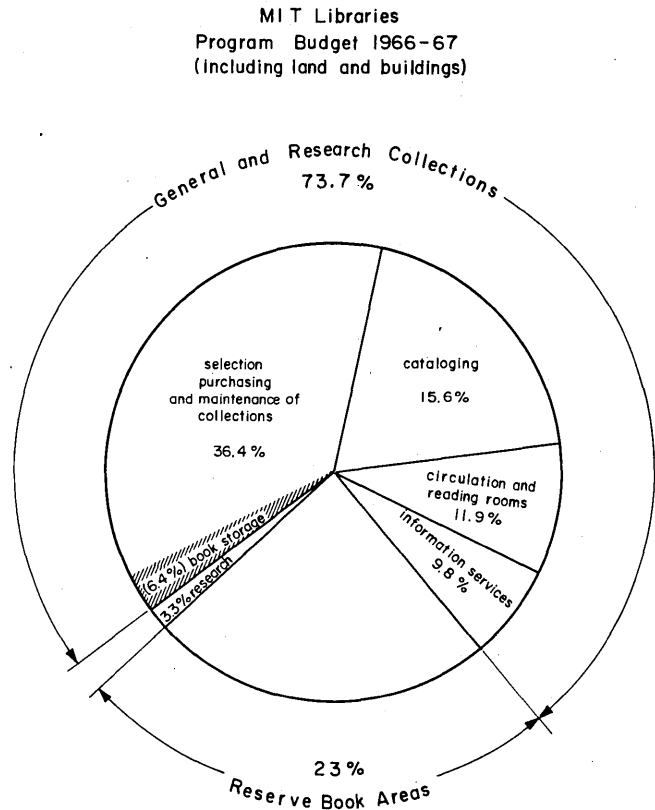

Fig. 1

A fact not shown in the figure is that 75% of all expenses are for salaries and wages. This proportion is high as libraries go and is explained by our many branches, long hours and small purchases of old and rare materials.

**what users do**

From this quick survey of where the money goes, let us turn to what people who use the library do and how librarians help. A study<sup>7</sup> in our science library several years ago showed that, of all who came in, only 5% leave a statistical trace by borrowing a book, a journal, or a report; and 40% come, not to use the library as such, but merely to sit and study a textbook, write a paper, meet a friend, or maybe take a nap.

Some of the remaining 55% go to the reference desk where librarians attempt to answer questions. These run all the way from simple factual queries, through the checking of a reference to a document, to really difficult, time-con-

<sup>4</sup>According to *Toward the Library of the 21st Century*, Bolt, Beranek and Newman, Inc., Cambridge, Massachusetts, March, 1964, p. 6, total titles then amounted to 200,000,000.

<sup>5</sup>*Library Statistics of Colleges and Universities*, Fall, 1968, National Center for Educational Statistics, USOE.

<sup>6</sup>This figure does not include Intrex, which is a research project in the School of Engineering.

<sup>7</sup>Bush, G. C., Galliher, H. P., and Morse, P. M., "Attendance and Use of the Science Library at MIT," in *American Documentation* Vol. 7, No. 2, April, 1956, pp. 87-109.

suming requests for all the information the library has on a certain topic. A year's analysis at the central reference department at MIT five years ago showed that 52% of the questions were bibliographic (that is, document identification), 28% were miscellaneous (where to find something, the hours the library is open, does so-and-so work here?), only 6% were subject searches (what have you on pulsars?). In other words, the fraction of the total budget going into sophisticated reference work is 6% of 9.8% or about .6%.

At the reference and information desk the interaction between users and librarians is direct. At the catalog the contact is indirect. In the science library study mentioned above, 17% of the users consulted the catalog. We have no breakdown of that use, but at Yale people are currently being asked how they use the catalog. Mr. Ben-Ami Lipetz has kindly given me the following tentative figures: 75% are looking up a known document. The other 25% break into three nearly equal groups: one is checking a fact like the spelling of a name or a date; one is searching for all the works produced by a particular author or group of authors; and the third is looking for works on a particular subject—compare the roughly 8% here with the 6% of subject questions at our reference desk.

An interesting comment made by a substantial proportion of Lipetz's users is that they had alternative documents in mind if they couldn't find the one they were looking for. It is hardly necessary to emphasize the value to the individual of having alternative strategies in case his first attempt fails. Insert a black box in the system, such as a computer, and it may become more difficult for the average person to devise and carry out alternative strategies. He will have to be led to see the range of possibilities that are open to him.

If you are interested in how people get at knowledge, you should study not just what they do in the library but what they do outside. It has been claimed that libraries are used only as a last resort. That depends on the position of the individual in the hierarchy. A man at the top is a member of what has been called the "invisible college." He can pick up the phone and call a colleague in Hamburg to get the latest dope. The average person apparently gets what he can from his co-workers before going to the information center. This is documented by two studies, "Flow of Scientific and Technical Information . . ." by H. F. Goodman, and "Communications in the Research and Development Laboratory" by Thomas J. Allen. Goodman shows that 80% of the time the individual tries to get answers to his queries without going to the information center; 50% of those surveyed used the information center or library once a month or less. Allen explains that a few "technological gatekeepers" are carriers of new ideas, picking them up from the literature and other outside sources and disseminating them among research and development people.

Students are stuck with libraries as they find them. They can't benefit from the "invisible college" and very little from the "technological gatekeeper." Of an estimated 30,000 people a week who use our libraries at MIT most are students. The best customers are graduate students. A study a few years ago<sup>10</sup> showed that, while undergraduates form

the highest percentage (46%) of users, three-quarters of their work is class preparation, so they require few books. Graduate students use the library in depth: They form 35% of the user population, faculty 12%, others 7%.

Since libraries are service organizations, we need to know what the customers want. Another study done in 1968 by Raffel and Shishko in connection with the work mentioned earlier gives some guidance. A random sample of faculty and students were asked what they thought were the main purposes of the libraries. They were allowed to check more than one, with the results shown in Fig. 2. Note the emphasis on materials for research.

Provide books and material for research	76%
Provide means to browse and read current journals	63
Provide required and recommended reading	61
Provide means to browse and read new books	43
Provide reference aids through professional libraries	29
Provide bibliographic services	27
Provide a place to study required and recommended reading	22
Provide a place to study your own material	20
Other	6
Provide informal place to lounge, relax, socialize	2

Fig. 2. Main purposes of libraries—survey of MIT faculty and students.<sup>11</sup>

Even more interesting is another part of the same study where choices were presented as to what services people would increase and what they would decrease, given an addition of \$200,000 to the budget, an extra \$100,000, or at the present budget level. The results are shown in Fig. 3.

Positive Cost Systems	Budget Levels		
	\$200,000	\$100,000	\$0
Increase acquisitions	1 <sup>13</sup>	2	2
Lower Xerox rates	2	1	1
LC messenger	3	3	3
Expand seating	4	4	4
Add reserve copies	5	5	4
Add reference	6	7	6
Increase access	7	6	7
Departmental libraries	8	9	9
All Xerox reserve	9	8	8
Negative Cost Systems			
Centralize reserve	1	1	1
Inexpensive storage	2	2	2
Cut reference	3	3	4
Cut seating	4	4	3
Decrease acquisitions	5	5	5

Fig. 3. Preference rankings by budget levels—survey of MIT faculty and students.<sup>12</sup>

"LC Messenger" means sending someone to the Library of Congress every week to bring back desired items. This assumes that he could get quicker service than a mail request.

"All Xerox reserve" means that all required reading selections would be copied and distributed free to members of classes instead of putting books and articles on reserve. This

<sup>8</sup> Douglas Paper 4516, McDonnell Douglas Astronautics Company, Western Division, 1968, presented to the 14th International Meeting, the Institute of Management Sciences, Mexico City, August, 1967—a survey of a representative sample of 1500 from a population of 120,000 scientists, engineers and technical personnel in 73 companies, 8 research institutes and 2 universities.

<sup>9</sup> Technology Review, Vol. 70, No. 1, November, 1967.

<sup>10</sup> Nicholson, N. N., and Bartlett, E. L., "Who Uses University Libraries?" College and Research Libraries, Vol. 23, No. 3, May, 1962, p. 217ff.

<sup>11</sup> From *Systematic Analysis of University Libraries: An Application of Cost-Benefit to the MIT Libraries*, J. A. Raffel and R. Shishko, MIT Press, 1969.

<sup>12</sup> From J. A. Raffel and R. Shishko, op. cit.

<sup>13</sup> Rank of system where rank of 1 means the system was chosen the most at that budget level.



option was estimated to cost \$80,000 a year additional. The difficulty of getting permissions for copying was not taken into account.

We will not go into all the implications of Fig. 3 but a research orientation again appears. While only a few (20%) desire a radical increase in acquisitions at the present budget level, a large increase is popular, given more funds. Virtually no one would decrease acquisitions to adopt any other option.

Lower Xerox rates were given such a high preference that we have responded by cutting them in half, though it meant switching to coin-operated equipment which can break even at 5¢ a copy.

Not shown in the table but of considerable interest is the fact that different groups choose different options. Undergraduates tend to prefer shifting funds away from research to reserve book facilities. Graduate students on the contrary want more research materials and increased access to the collections of other libraries. The faculty (49% at the \$200,000 budget level) ask for departmental libraries—and we have already moved on this for physics and chemistry.

Perhaps an appropriate way to conclude this section on what people do and want in libraries would be to quote Philip Roth on the announced decision of the Newark City Council to close the Public Library<sup>14</sup>:

"The library wasn't just where one had to go to get the books; it was as much a kind of exacting haven to which a city youngster willingly went to get his lesson in restraint, to learn a little more about solitude, privacy, silence and self-control.

"And then there was the lesson in order. The institution itself was the instructor. What trust it inspired—in oneself and in systems—to decode the message on the catalogue cards; then to make it through the network of corridors and staircases into the stacks; and there to find, exactly where it was supposed to be, the right book."

Now we shall turn to computers, what they can do for libraries and how we can pay. Most of the applications of computers to libraries so far have been carried out with soft money, that is, grants; but the days of soft living are nearly over. Federal money and foundation money are tight. As we go into applications to our own libraries, we can hardly expect anybody else to foot the bill. We are going to have to pay for them out of hard money, appropriated from the general funds of the university in competition with salaries. At most we can hope for special appropriations to input a backlog or to write a program; but for day-to-day operations, believe me, the eye of Big Brother is as nothing compared to the cold eye of the comptroller.

The Library of Congress and the university libraries have always been leaders in adapting new ideas and new hardware to the service of the public as soon as they are feasible: the first comprehensive classification systems, Dewey Decimal and others; the 3" x 5" printed Library of Congress card, used all over this country and abroad; microforms; photocharging; embossed or punched library cards. As to quick copying machines, they are already credited with making a billion copies a year in U.S. libraries. They, not computers, are the real revolution in library service in the last 10 years.

The computer revolution has hardly started. Libraries large and small have been experimenting for a number of years, and partially automated systems are springing up. Most of these are "dedicated systems"; that is, the system was designed to fit the hardware, rather than the reverse

which is the ideal. The same is true in computer-aided administration, and it is there that computers have made their greatest contribution so far. Personnel and fiscal records in many universities have been computerized and the libraries are sometimes included.

The next area of application is, it seems to me, inventory control by computer. Industry has proven it out. Publishers' warehouses have adopted it widely.

While a library may seem superficially to resemble a publisher's warehouse, it is much more than that. Take the amount of work that goes into preparing a book for retrieval. This is 33% of our total expenditures, not including the cost of the books themselves but only salaries, materials and supplies used in selection, purchasing, cataloging, card preparation, filing and shelving. We are now running an experimental project on control of purchasing by computer, extending through catalog card production<sup>15</sup>. The technical problems are harder than we thought but still easier than the financing; for we have to run parallel systems for a year or so before we dare to switch over. It takes quite a while to get a new system up and running. Within limits, the more of our processes we can get computerized, the better chance we have of matching the costs of the manual system. My best guess as of now is that computerized inventory control will cost 10% more.

This will have to be justified on the basis (1) that we will have a machine-readable by-product that can be used later in circulation control and ultimately in a remote accessed catalog and (2) that typists to do orders, lists, and catalog cards simply cannot be found—we have five openings for typists in our catalog department right now—but you can get Flexowriter operators because their status and pay is higher. The latter argument may be the clincher.

Here are the operations that within a few years we hope to have computerized: orders and follow-ups; status of orders (printouts or on-line); status of items in processing; production of author, title, subject and shelf list cards (as long as we maintain card catalogs); special lists (new books, shelf lists for inventory, bibliographies); book catalogs; labels; routing slips; book cards; circulation control; and bindery records. The best candidates are clerical operations. Cost is the key. We will bring in computers the minute they can do the same job for less money or a better job at a price we can afford.

#### storage costs

Now we will turn to storage and compare conventional and computer costs. Book storage is one of the cheapest things we have today. Even amortizing land and building cost, we can keep an average book on the shelf for a year for 20¢. At 10 million bits per book,<sup>16</sup> this is 2¢ per megabit year. The card catalog is somewhat more expensive at 30¢<sup>17</sup> per megabit year. For off-line tape storage the technical information project of the MIT Libraries pays \$7.47 per megabit year. On-line disc is \$237 per megabit year. Incidentally, neither of the last two figures includes the non-negligible cost of maintaining "daddy" and "grand-daddy" backup tapes.

In a sense one can say that the books in library stacks are off-line. You may have to walk quite a way to get what you want. So the 2¢ figure is comparable with the \$7.47 for off-

<sup>15</sup> See Mattison, E. M., "Library Catalog Card Production Using TIP Subsystems," TIP-AN-106, Technical Information Program, The Libraries, MIT, Cambridge, Mass., March 7, 1969.

<sup>16</sup> 500 pages, 500 words/page, 5 characters/word, 8 bits/character.

<sup>17</sup> 8 bits/character, 500 characters/card, 3125 cards/ft<sup>2</sup>, \$3.80/ft<sup>2</sup>.

<sup>14</sup> *New York Times*, Guest Editorial, March 1, 1969.

line computer storage. The cost differential is a factor of almost 400. What this means for MIT is as follows: take the \$120,000 a year that we spend keeping the general and research collections on the shelves, multiply that by 400 and you find that it would cost \$48,000,000 a year to store those books on tape. Moreover, with present hardware it would cost a lot more to find and output a book than to pay a professor's salary while he walks to the library, consults the catalog, finds the book and borrows it. After all, a \$20,000 a year professor only costs about \$12 per hour. Say \$15 with overhead. All these figures prove is that nobody is going to put whole libraries on tape at today's prices.

Many people think we can put the card catalog on-line, and wouldn't remote access be wonderful! Sure. Let's look at the costs. Call the card catalog on-line, which it is if you're standing there. (The computer is only on-line if you are sitting at a terminal.) Compare the costs of the two on-line catalogs: 30¢ per megabit year for the card catalog vs. \$237 in disc file, or 800 times as much. In reality the picture is only a quarter as black because the computer needs to store the equivalent of just one card per title instead of the present four. So the cost would be only 200 times as much. The \$3000 a year we now pay for space for the catalog would cost \$600,000, but that is not the whole story.

As a first approximation, we will assume the cost of input into the manual and the computer system is the same. Output costs are now borne almost entirely by the customer providing his own time, but the situation changes radically when you computerize. A study at the University of Chicago<sup>18</sup> came up with a cost of \$1000 for one pass through their catalog on tape. The present cost of a search by a librarian might be one dollar. Using my figures for card vs. computer catalog storage, it costs Chicago \$3,600 a year at present for card catalog space, and on-line storage would be nearly \$2,850,000 a year. Tape storage would be \$90,000, but tape is out of the question—the catalog of a library that is in active use has to be on-line.

In concluding this section I can hardly do better than quote from "The Impact of Technology on the Library Building."<sup>19</sup> This remarkable study published in 1967 is still valid.

"Totally aside from costs, there are technological and intellectual problems of the greatest magnitude to be overcome before computerized catalogs will be generally usable. Direct access files of larger storage capacity than presently available in computer systems will be required to store the catalogs of great research libraries. The capability of simultaneous consultation of the catalog by very large numbers of users must be expanded . . . Problems of what terms and how many to use in describing catalog information must be resolved. Programs to retrieve only the materials specifically required by a user must be developed. But, despite these problems, it is

<sup>18</sup> "On Research Libraries," Committee on Research Libraries, ACLS, 1967, p. 45ff: 5 million cards in the catalog, 300 characters ea.; total, 12<sup>9</sup> bits; 80 reels of mag tape, 60,000 cards per reel; time for one pass, 5 hours. Miss Patricia M. Sheehan and William D. Matthews of the MIT Technical Information Project assisted with the cost calculations in this paper. Miss Sheehan comments further on tape catalog output costs: "If tape catalog is in traditional, alphabetical order, the program could maintain a short directory tape listing the first and last record in each reel. If the system requires a substantially accurate entry—principal words in correct order—only one reel need be passed at 1/80th of the cost. If the system accepts mangled requests, Hobson's choice lies between additional reels for an inverted file index and additional passes of the entire file—at even more unacceptable costs."

<sup>19</sup> Educational Facilities Laboratories, New York, 1967, pp. 10-11.

<sup>20</sup> In an unpublished paper, "Information Technology for Network Operations," kindly communicated by the author.

expected that within 10 to 20 years, the use of computerized catalogs will be widespread."

I share the general optimism but, having been burned in making predictions about translation by computers some years ago, I would rather avoid specifying the number of years. Small, high use catalogs, yes; but for large university catalogs, we must have improved data compression, cheaper memories, true random access, or all three. The rate of technological progress is high, but a cost differential of two orders of magnitude is a formidable challenge.

#### transmission costs

As with storage, a large cost differential divides conventional transportation from electronic transmission. John Simonds of Eastman Kodak<sup>20</sup> has compared the cost of chartering a Boeing 707 and loading it with microfilm with that of using Telpak D to transmit the same number of bits from New York to Los Angeles. This works out to \$10,000 for the Boeing (.63 x 10<sup>-7</sup> per megabit mile) vs. \$2,700,000 for Telpak D (.177 x 10<sup>-4</sup> per megabit mile). Book rate parcel post at 24¢ per volume would be .53 x 10<sup>-5</sup> per megabit mile, using Simonds's values for words per page and bits per character.

Transmission and transportation costs are not really comparable because some of the variables are not "well behaved." Transmission time is zero, or practically so, regardless of distance in electronic systems, but bandwidth is a controlling factor. Time may be a key factor in transportation systems, but bandwidth is unlimited. Other important variables to be kept in mind are the form of the original

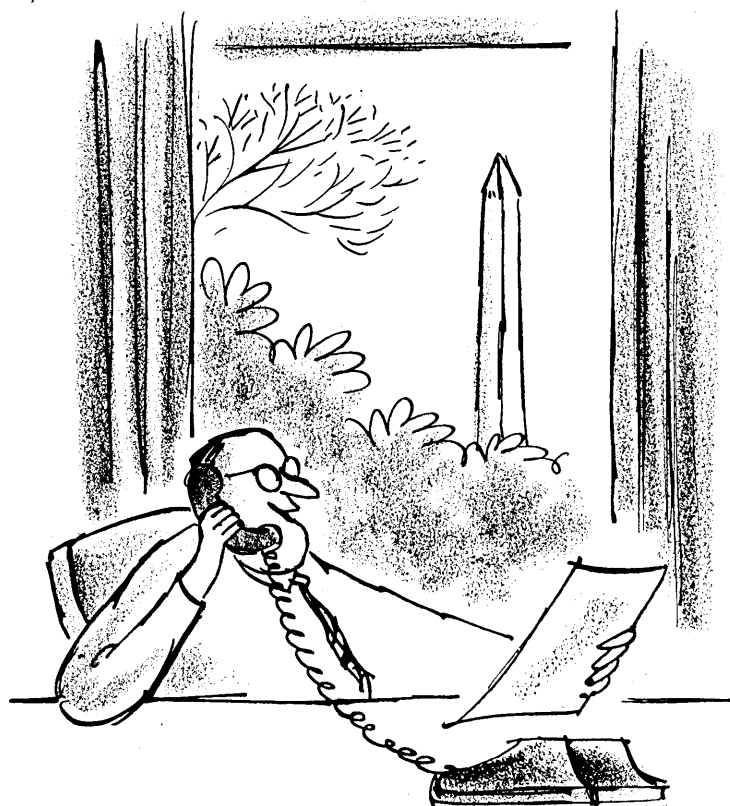

" . . . and by the way, thanks an infinity for the budget figures."

information (print, film, or magnetic) and the quantity to be transmitted.

The fragmentary and specialized nature of the above figures is unfortunate, yet we lack better data. Prototype information networks are being constructed by government, industry and universities. It is said that some have already been tried and abandoned because of excessive cost, low use factor, or other reasons. Those who are predicting or planning library networks should take all the facts into account. Wishful thinking about present and future costs may give us librarians a black eye with the very administrators who are urging us to "get with computers."

### information retrieval

In 1952 Louis Ridenour said:

"To describe its potentiality the computer needs a new name. Perhaps as good a name as any is 'information machine.'"<sup>21</sup>

Up to this point I have tried to avoid using the word "information" for lack of a good definition. Fairthorne, one of the best theoreticians in library and information science, says:

"Current ambiguities, such as the various very different uses of 'Information Retrieval,' to say nothing of 'information' seriously obstruct joint discussion . . ."<sup>22</sup>

These "different uses" go all the way from the specific datum (the author of a book, the lasing frequencies of argon, or the number of fatherless, dependent children in Ward Nine) to the insight-requiring subject search (what did Nietzsche write that could have a bearing on the present campus disorders?). We are doing something still different if we derive from the text something that is only implicit. Take an example from Yu. A. Schreider in "Semantic Aspects of Information Theory"<sup>23</sup>:

"The machine which perceives semantic information should be able not only to store the received information, but to make some logical conclusions. So, it is possible to speak about a machine that understands the text of *Eugene Onegin* if it, for example, can answer to a question: 'On what day was the duel between Onegin and Lensky?'"

"There is direct implication to the fact in the text [sic], but it is known that the duel took place on the next day after Tatyana's name day. As the date of Tatyana's Martyrday (January 25) is known from the orthodox calendar, then the date of the duel can easily be calculated."

Max Woitschach of IBM Germany probes deeper into the difficulty in an unpublished paper:

"There is really no identity between words or sentences and the actual information. This means, that one and the same word or sentence may have a completely different meaning to different people."<sup>24</sup>

In other words, information is *not something we read out of a document, but something that we read into it*. It is our interpretation in the light of our own prior experience. Anyone who wants to spend a little time programming can

do data retrieval. It doesn't matter what the datum is, whether it is a number, a word, or a paragraph, as long as it is formatted and tagged in such a way that you can retrieve it with a properly formatted and tagged query. But no one today is doing information retrieval with a computer in the sense in which Schreider and Woitschach are talking about it. In short, computers can do data retrieval but not information retrieval in the sophisticated sense of the word. In fact, "information retrieval" is a contradiction in terms if the "information," like beauty, is in the eye of the beholder. It might be added, in passing, that information theory often gets lost in this same semantic quicksand.

To return to firmer ground, we saw in Fig. 1 that only about 10% of MIT's library expenses goes into information and reference services. Later we looked at studies that indicated that only 6% of information and reference work goes into subject searches. These figures are recalled as a basis for estimating how many dollars might be available for computer applications in this area. We spend some \$200,000 a year on "information services" in the broad sense, \$12,000 for the really difficult subject work. These numbers sound picayune when you think of how much each consultation of a catalog on disc will cost—and please keep in mind that you can't batch this kind of work unless the time lag for delivery to the customer remains of the order of minutes at the most. Some 5,000 people a week use a catalog at MIT.

There is some difference of opinion as to who should carry out the application of computers to libraries. A systems analyst will tell you that he, of course, has to lay the groundwork; then obviously you need expert programmers. This school of thought says, "Let the librarians tell us what they do now and what they want to do, then let us do it." Another school says, "There is no alternative to library experts learning computation."<sup>25</sup> According to the second theory, librarians must learn to do systems analysis and programming in order to work out their own salvation. I take a compromise position; namely, that this is a joint problem and requires a joint task force type of solution. We must have systems analysts, programmers and librarians working together sympathetically, not to say symbiotically, to get the job done.

### conclusion

In thinking about the application of computers to libraries, we have to keep these things clearly in mind: what we know how to do, and what we don't; what costs are; and what we can afford.

We know how to do inventory control; we know how to do data retrieval; but we don't know how to do information retrieval in any sophisticated sense. We have almost no hard facts about costs in large operations. We can afford as much inventory control as can be handled within present budgets, plus normal increases. We cannot afford on-line catalogs. And anybody who talks about storing any number of books, even off-line, is off his head.

In order to end on a more optimistic note, I close with a quotation from Fred C. Cole, President of the Council on Library Resources:

"In sum, the technology is expensive and uncertain, both the research and development and the equipment. Nevertheless, library problems will worsen and the remedies grow more costly if the subject of automation is neglected today."<sup>26</sup>

<sup>21</sup> Ridenour, L. N., "The Role of the Computer," *Scientific American*, Vol. 187, No. 3, March, 1952, p. 117.

<sup>22</sup> Fairthorne, R. A., "The Scope and Aims of the Information Sciences and Technologies," *Theoretical Problems of Informatics*, FID Publication #435, International Federation for Documentation, Study Committee "Research on Theoretical Basis of Information" (FID/RI), All Union Institute for Scientific and Technical Information, Moscow, 1969, p. 29.

<sup>23</sup> FID Publication #435, op. cit., p. 155.

<sup>24</sup> "Problems of Mechanical Documentation and Its Impact on the Development of the Third World," available from the author.

<sup>25</sup> "Report of Committee on Research Libraries," American Council of Learned Societies, Washington, 1967, p. 49.

<sup>26</sup> Annual Report for 1968.

# COMPUTER SUPPORT OF THE RESEARCHER'S OWN DOCUMENTATION

your very own library

by Theodor B. Yerke

The major effort in library automation has been directed to the solution of large-scale problems in bibliographic and subject control. The activities of the three national libraries and of commercial and professional abstracting services are prime examples. No one can deny the importance of a national information network and improved national bibliography. But the concentration of nearly all efforts in these areas also tends to obscure other problems which are no less fundamental.

Librarians, by the nature of their training, have an implicit faith that better organization of libraries and library resources automatically solves most of the problems which beset users of libraries and technical literature. This belief assumes that what researchers do in the organization of their own work is a small-scale reflection of what librarians do on a larger scale with big literature collections. There is increasing evidence that this simply is not so. In particular, it is just not true that complete central control of subject literature is the primary bibliographic accomplishment which *directly supports* the bench scientist.

Not all scientists are located adjacent to major research libraries, and most who are report all sorts of difficulties in the utilization of the very collections and services which are presumed being maintained and offered for their use. The fact that these scientists get their research done anyway is the one factor which no one had studied much until very recently. For if researchers are as dependent on library resources in the way in which both they and librarians aver, how is it possible for those with poor access to research collections to do their work at all?

Some librarians knew 10 years ago, and many more know now after a decade of further study, that scientists do not learn of the most important developments pertaining to their work by visiting the library. They do rely on libraries to get specific materials, but often only as a last resort. William J. Paisley, at Stanford, has proposed models showing how information is really communicated among scientific groups. The results of his work and many other investigations concerning the use by researchers of libraries has been, to most librarians, a disturbing revelation.

## the users were asked

When we began library services at the Forest Experiment Station in Berkeley in 1960, there was great cynicism in some quarters about what good library service might be. The great library resources of the University were two blocks away, and they often were of little or no help. A

committee of staff scientists was solicited for their suggestions on what was best to do. It shortly was clear that the resentment was not against the existence of the nearby library resources as such. It was against the way they were organized.

One thing which I was most definitely asked *not* to do was to construct a station library subject catalog based on the traditional alphabetic subject headings. Library efforts at the subject organization of library holdings had been of little help to our scientists, either while they were doing their graduate work or since. We went ahead and organized the usual basic library services, minus a subject catalog, while studying the question of what we might do to support our research staff in some really meaningful way.

The 150 scientists at the Berkeley station represent more than 30 major disciplines and dozens of subspecialties. The diversity of interests include those of social scientists, economists, mathematicians, toxicologists, landscape architects, industrial engineers, meteorologists, operations analysts, and photogrammetrists. In addition, there are the usual fields which the public associates with forest research: silviculture, plant physiology and genetics, forest entomology and pathology, wildlife biology, wood technology, ecology, soil science, and hydrology. Any library subject catalog designed to serve *all* their interests would be as general as the subject arrangements in the university catalogs and just as unsatisfactory.



Mr. Yerke has been chief librarian of the Pacific Southwest Forest and Range Experiment Station (U. S. D. A. Forest Service), Berkeley, Calif., since 1960. He has represented the Forest Service on several National Agricultural Task Forces. In 1968/69 he was Charles E. Bullard Fellow in Forest Research at Harvard. Mr. Yerke has a BA from UCLA in German and a degree in librarianship from UC, Berkeley.

## COMPUTER SUPPORT OF RESEARCHER'S DOCUMENTATION . . .

It became increasingly clear that the true subject resources of the station were not in the library, but consisted instead of the personal information files, with their supporting indexing and documentation systems, that most of the scientists maintained in their offices and laboratories. Why not support this activity with automation and professional information-handling experience?

The Berkeley station has excellent access to computer facilities, along with vigorous leadership in biometrics and many computer users and programmers. Almost as a matter of course, by 1965 we had computerized our author and title catalogs. Before we could plan a computer-based system to support the personal documentation efforts of our scientific staff, it was necessary to better understand the nature of that activity. For several months I investigated the growing literature on the subject of research on research. It substantiated many things which I had felt experientially as a librarian, and there clearly was a relation to our problems at the station.

### researchers work differently

The one thing that this literature established is a very fundamental difference between the aims of librarians, whom we may call macrodocumentalists, and researchers, whom we can think of as microdocumentalists. Macrodocumentation, as practiced in general libraries and by abstracting services, must relate publications in a field to the whole body of literature pertaining to that subject. Research libraries and their collections serve a general archival purpose. They strive for comprehensive coverage and permanent retention. The point of view in their subject organization must be universal and discipline oriented.

The aims of a researcher are far more subjective, however objective his science and methodology must be. The organization of his information reflects an attempt to evaluate items in accordance with a working concept, by means of which he is seeking to test the validity of some hypothesis. When he evaluates literature, citations to literature, or abstracts from literature, he is evaluating somebody else's thinking and work. The bearing of this on his own work may be very explicit, or it may be only intuitive. Time, and the further reading of yet other papers, will often determine the "meaning" of a given document.

### a much smaller circle

When a researcher makes abstracts and assigns index terms this is really a creative act. As time passes and further information is gathered, earlier items thought to be explicitly related may become extraneous. He may have gathered evidence that forces him to recast his whole hypothesis. When this happens, the contents of the file assume new "meaning." That part which is retained may have to be reindexed. As this process continues, the items in the file which survive repeated scrutiny, achieve very high relevance. This relevance is of a far different order than the relevance of materials indexed in public collections and by abstracting services. The information retrieval problem is different too. When he searches his own file, a researcher is conducting a special kind of synthetic exploration of his own earlier documentation.

In contrast to the comprehensive and permanent nature of library collections and their indexes, the personal file of a researcher is eclectic, idiosyncratic, and labile. This aspect was described in much detail by Douglas C. Engelbart in a paper given to the American Documentation Institute in 1961. He stressed then that research was needed on docu-

mentation problems of the individual, and believed that researchers suffer more from the problems of maintaining their own files than from those of keeping up with the formal bibliographic record. The audience was not visibly excited by Engelbart's paper. That was a period when attention was focused on the solution of all documentation problems through large, central systems. It is interesting that 10 years later a major recommendation of the SATCOM report is the development of user-oriented repackaging services.

### encouraged individual systems

During our investigation of personal documentation we relied heavily on discussions with our own scientific staff. The results of these talks correspond very closely to the literature accounts of the problems that individual researchers have with information organization. We also helped several pioneer users convert their records to a machine readable form that would run on CATALOG, the program that produced our library catalogs. This ran on the IBM 7090-7094 DCS. Experience with these pioneer users further revealed needs that should be considered in our design plans.

We knew that the station would shortly have access to large, third-generation computers on which it would be possible to operate a truly homologated system which would escape from the limitations of CATALOG and of earlier similar systems that we knew about. We wanted the computer to take over the clerical jobs of updating and maintaining a record file, while also freeing the system user, through other system features, to index and structure his records according to his own requirements. We would coach and consult but not prescribe.

### user does his own indexing

Our idea was to provide our users in effect with a *tabula rasa* upon which they could write their notes and abstracts with a minimum of distraction. The technology which subsequently manipulated their input to serve various user needs must be entirely out of sight. Handwritten input, upon being given to a secretary or to an input station, would be converted to the simple input format for key-punching. At every point, the guiding principle had to be the greatest possible editing, sorting, deleting, revising, indexing, and searching ease for the user, within a framework of feasible input and item-size limits.

I had worked closely with the station senior programmer, Robert M. Russell, in the design of CATALOG. He was now assigned to program the new system, for which we obtained support from the Forest Service research branch in Washington. It was named FAMULUS, the title of the private secretary to a mediaeval alchemist or scholar. The general outline of FAMULUS was completed in the summer of 1967. As I was away from the station the following year, Mrs. Hilary Burton, our computer services librarian, assumed the close liaison work with Russell. FAMULUS is written in FORTRAN IV, ASA standard, with the exception of assembly language in several short routines. The CDC 6400 and 6600 versions were completed in June, 1968. A conversion to the IBM 360 was finished in September, 1969, under contract at the UCLA Campus Computing Network. There is also a Univac 1108 version. Most potential users in the Forest Service had access to one of these three machines. The IBM version will run on the 360/40 and larger systems.

FAMULUS actually consists of eight subsystems, each of which performs a specific set of tasks. EDIT writes punched

card input onto tape and permits the user to make corrections, additions, and deletions. SORT rearranges the file order by changing the order of fields within the records so that the file can be realphabetized. MERGE provides updating facilities and permits enlargement of the file through merging two individual files into one master file. GALLEY prints the file in any of several formats. INDEX lists keywords and tells in what records they may be found, in effect providing an index. VOCAB prints in alphabetic order all "meaningful" words in any given field, of the records in a file, making a list of index terms, keywords in titles, etc. SEARCH scans the file and matches keywords in the title or descriptor fields, retrieving and printing out only those records matching the search question. OSSIFY punches card deck equivalents of tape files, for use as safety decks or for massive corrections.

By June, 1968, we already had two years' working experience with our pioneer users. Their files were now converted to FAMULUS from CATALOG at no inconvenience or cost to them. FAMULUS operations began with more than a dozen scientists' files, whose contents were each structured according to the need of the scientist. There are presently nearly 30 such collections, several of which are at other Forest Service Experiment Stations in Oregon, Colorado, and Minnesota. The availability of the IBM 360 version will permit the compilation of FAMULUS at still more locations. There has also been a lively stream of enquiry from the academic and private sectors, indicating wide interest in the idea of automating smaller, personal documentation resources.

The collections presently on FAMULUS average between 700 and 2,000 citations, though several are nearer 10,000. Most users add about 50 new items per month. FAMULUS users have been satisfied with the costs of using the system, which they pay out of their operating budgets. A collection of 500 citations, averaging seven EAM cards each, may be written on tape, sorted as the user wants, indexed and produced as a printout, for a total of 4.5 to 5 minutes of CDC 6400 system time. Cost does not increase linearly with more citations; 1,000 citations will take about 7 min rather than 10 to process. Citations can, of course, include abstracts and be up to 40 EAM cards in length. This will also increase processing time.

### **each retains his own style**

The variety of collection structures which the existing files exhibit appears to corroborate all the statements in the literature about the need and desire of researchers to have maximum freedom to develop their own documentation patterns. Several users have devised elaborately structured formats for their input, similar to a MARC approach. Others find that a freer form, relying only on title terms or a few assigned keywords, meets their organizing requirements. The nature of their research, in relation to the characteristics of the literature they monitor, is a large factor in their decisions. The over-all result is a number of in-depth collections, broad-based collections, and multi-user collections—all machine readable and all available, with the consent of their owners, to the library staff and to other researchers as resources for information work.

The impact of FAMULUS has obliged us to restructure our thinking about the station library problem and the place of local library services within the emerging national information network system. We have been operating under a field library concept that reflects the conditions existing in the scientific community and in library technology before 1950. The field library was viewed as a depot operation of the central or departmental library in Washington. It was a

little, and limited, version of the big library—whose librarian looked wistfully out to the great library resources of universities and national libraries where, he felt, there was everything he needed, but to which he had chronically inadequate access.

Now we can consider a model in which the spheres of the two kinds of library services are both distinct and complementary. The old, insoluble problem of access to the central archival collections will in time be solved for remote units by telecommunications and information networks. The real value of library or literature services, located at the research unit, will be as repackaging and transfer operations at the interface between the necessary activities of macrodocumentation and microdocumentation. The defining parameters of these missions will be found where these documentation activities intersect and their products have to be mutually transferred back and forth.

### **users become better indexers**

There will be many results from this mode of operation which we can now only begin to see. Radical new technology does more than merely make it possible to do things more rapidly and efficiently than before. It reshapes the attitudes, and even the personalities, of the persons caught up in it. The growth of computer-based information services, and the necessity for libraries to adjust to them and exploit them, is already reshaping the image of librarianship and the self-image of librarians. We have observed that, as researchers convert their files to the FAMULUS mode of operation, they too begin to turn on in new and different ways.

Everyone who has worked successfully with information retrieval programs begins to think more explicitly and clearly about the problem of organizing and searching files. It is in the nature of program structure and search logic to force this adjustment. Some of our researchers have realized with surprise the extent to which their former ways of organizing their own information was fuzzy and inchoate. The staff of the library's computer services unit has been drawn much closer to the research staff by working with them in the structuring and processing of their collections. Some researchers have begun more lively interchange with their colleagues. Parts of their files are usable by others with similar interests. One research unit wants to merge selected sections from each member's file into a central file from which unit reports and summaries can be drawn. Individual files will still be maintained by staff members to preserve their own idiosyncratic slants.

### **go on from here**

Hopefully, information system designers and research administrators will become more fully aware of the important differences between the documentation needs and habits of research teams and the characteristics of library and information network systems. The antagonism between the two activities is truly only an apparent one. Both functions are different and necessary organizing stages in the development and flow of new knowledge out of the experimental phase into the standardized structure of the permanent public record.

Much needs to be learned yet about the nature of personal documentation and its relation to general information structure. FAMULUS is simply an initial step in this direction, representing the present computer and systems technology at the off-line level. There is much investigation going on, both in systems concepts and in research, on how research is done. All of this can be drawn upon in future improvements on the FAMULUS concept. ■



Send  
6,000 characters  
over 2,500 miles  
in 10 minutes  
for \$3.25

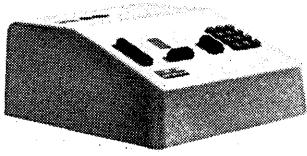

With DATAKWIK. Suppose you have an inventory report on your L.A. warehouse (or a day's orders, a truck routing schedule, a sales report, etc.). And suppose you want to send it to your New York office.

All you do is record data into a portable, tabletop DATAKWIK, hook it up to a standard Data Set, go home and someone in New York can place a night rate call and automatically receive the data. You're ready to start over the next morning. (And, of course, transmission is even cheaper if you're in the next state, the next city, the next block.)

DATAKWIK. An easy-to-operate, inexpensive, off-line information input, storage and retrieval system for reliable high-speed transmission of data over ordinary telephone lines. You can send up to 6,000 characters at a time. Use it any time of day or night . . . when you want to or when the receiver wants to. Transmit the data into a printer, a teletype unit, a central computer . . . DATAKWIK is completely adaptable to any system. Operate it yourself or let a clerk do it . . . it's as easy as using an adding machine keyboard. No master codes, no complicated training.

DATAKWIK. Interested? Write for more information to:

**DASA**

**DASA CORPORATION**  
DATA PRODUCTS DIVISION

15 Stevens Street  
Andover, Massachusetts 01810

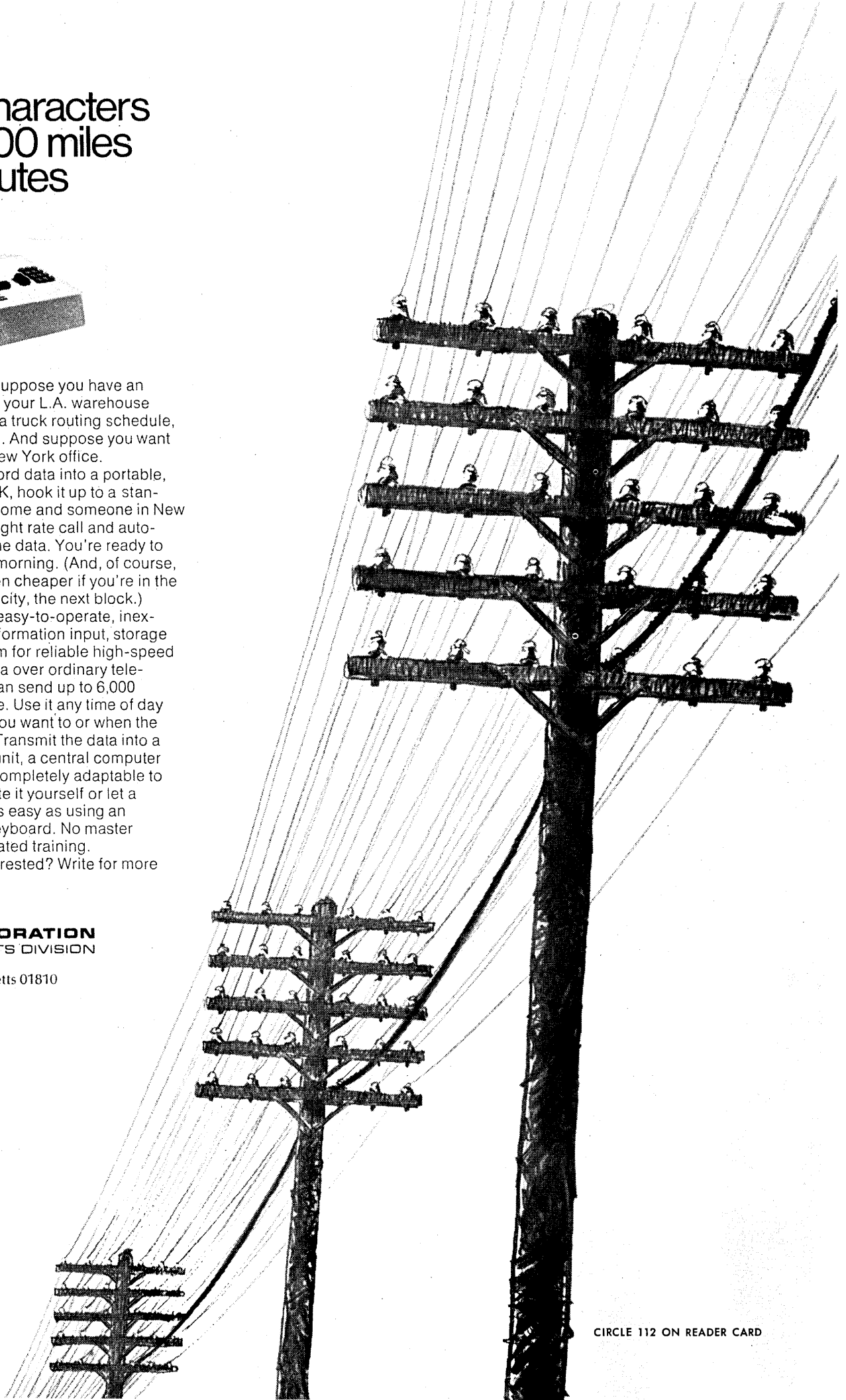

CIRCLE 112 ON READER CARD

# BIBLIOS— A MODULAR SYSTEM FOR LIBRARY AUTOMATION

by John C. Kountz and Robert E. Norton

The Orange County Public Library System consists of 26 separate branches and a centrally located headquarters. From headquarters, these branches are provided administrative services, centralized material acquisition, and technical processing. As a first approach to edp, centralized acquisition was partially automated on the county's IBM 1460 in terms of what has been called the Book Procurement Program (BPP). That system, placed in operation in January, 1966, literally paid its own way. In the years following, it was "adjusted" and recompiled to function on an IBM System/360 Model 30, and finally on an RCA Spectra 70 Model 45 E. Like the proverbial gadget, it ran like clockwork—regardless of the stones cast in its path. The trouble was, from a librarian's viewpoint, it didn't give the right time.

This latter feature was suspected from the onset. However, as an acquisition tool, the BPP was relatively infallible. Only on close examination of the library's specific goals and functional parameters did the implication become vivid—an examination, it might be added, which began in March, 1967, and continues to this day. Specifically the goals were, and are:

- An acquisitions program
- Book catalog
- Circulation control system
- Public information retrieval system

In its original form, the BPP represented a significant first step by the Orange County Public Library (OCPL) towards automation. As a didactic tool, it served to establish the potentialities of edp for the library while, in addressing itself to but one of the library's goals, it also served to highlight contemporary business system approach inadequacies. The result was obvious: a more comprehensive library-oriented foundation was required.

## a new system

In March, 1967, the Book Inventory Building and Library Information Oriented System (BIBLIOS) began its formal gestation. At that time, all areas within the library, where the original BPP had impacted, were studied in depth. Documentation prepared before and after implementation of the original system was compared to discern what benefits had or had not accrued. Of interest was the unequivocal acceptance of the original system by those who were in daily contact with it; this, in direct contrast to those factions who saw only by-products and were not convinced that such an enterprise could endure.

The study resulted in a preliminary, but detailed, systems specification which embodied both corrections to the original system and over-all guidance provided by the library's major goals. Briefly, and in a tactical sense, these goals resolved themselves into the following functional parameters:

- Provide increased patron service by minimizing the time

- necessary for procurement, bibliographic display and inventory control.

- Eliminate redundant manual effort in the capture of bibliographic and inventory data.

- Increase the accuracy, timeliness and scope of management controls.

- Expand the system to handle data for library materials other than books.

- Establish standards through which automatic communications with outside organizations could be effected.

- Provide a broad range of uses for data derived in the course of the conversion of existing files, including catalog production, circulation, inventory, and collection/community SDI techniques.

- And finally, within this framework the system was to be composed of subsystems, or modules, each capable of accommodating all activities relating to a specific library function, e.g., acquisitions, MARC, catalog production, etc.

Orange County Public Library's analysis and design efforts culminated in July, 1968, at which time Century Information Sciences, a private software firm, was engaged to form a project team creating the modular system outlined in the following pages.

## the system in brief

BIBLIOS is a modular system comprised of six functionally discrete subsystems, each in turn being divided into recurring batch processing cycles:

SUBSYSTEM  
MARC

BIBLIOGRAPHIC  
PROCUREMENT

CYCLE  
MARC Print  
MARC Select  
Bibliographic  
Pre-Order/Order  
*(Continued on p. 80)*

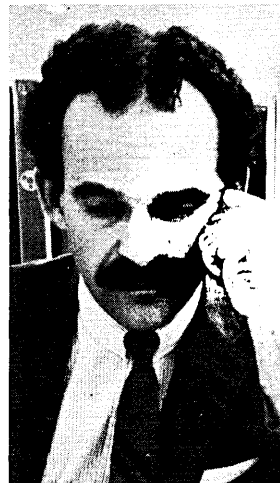

Mr. Kountz is library systems analyst with the Orange County (Calif.) Public Library. He has had 10 years' experience in the computer field and was formerly with Autonetics, Hallamore Electronics, and Hughes Aircraft. He has an AB from Mexico City College and an MS from the University of Southern California.

INVENTORY  
SPECIAL REPORTS  
PROJECTED BRANCH

Receipt/Cancellation  
Invoice  
Budget  
Vendor  
Inventory  
Special Reports  
Pre-Order

The total system encompasses 25 processing programs of varying levels of difficulty, all written in COBOL v version 15. The system is compiled to function on an RCA Spectra 70 model 45 with six tape drives, one disc drive, and 50K core maximum. With minor exceptions, each subsystem is a stand-alone entity capable of functioning independently or in concert with other BIBLIOS subsystems.

In the following, the significant features of each subsystem are examined and, where applicable, accompanied by sample report pages to illustrate the type and form of the data being handled.

**marc subsystem**

The purpose of the MARC subsystem is to interface with the MARC (MACHINE READABLE CATALOGING) file produced weekly by the Library of Congress. These files consist of recent library materials and provide OCLP with full cataloging data captures by LC; because of the currency and reliability of this data, it effects three library functions:

- Standardization of subject headings (LC assigned),
- Elimination of the manual search effort usually associated with determining and verifying bibliographic data.
- Provision of an additional book selection tool.

Processing the LC-prepared MARC file into the MARC subsystem involves several steps. First, the data is coded in ASCII and must be translated into EBCDIC. Second, the entry on the MARC file, which is divided into a varied number of fields, is transferred to the format used by BIBLIOS, which is divided into a variable number of fixed-length, fixed-format fields. Therefore, the entry must be analyzed as prescribed in a comprehensive set of rules and the required fields transformed to meet BIBLIOS requirements prior to being received by the system. This transformation is complicated by three factors:

- Several fields may have to be analyzed to determine the nature of a field significant to BIBLIOS.
- Diacritical characters, which occupy a position in a field, cannot be utilized in BIBLIOS because of equipment con-

straints and therefore must be deleted from the field during the transformation process.

MARC provides more data than can be accommodated in the BIBLIOS format. This additional data is displayed to guide the development of a bibliographic entry but is not transferred directly.

Of importance to the handling of data from MARC into BIBLIOS is the structure of the keys used by each. Entries on the MARC file are uniquely defined using the Library of Congress card order number thus:

DATA ELEMENT	SIZE
Alphabetic prefix	3
Year (or series)	2
Number	6
Supplement number	1

Entries in the MARC subsystem (and significantly throughout BIBLIOS) are defined by the following "LC/OC Number":

DATA ELEMENT	SIZE
Year	2
Number	6
Alphabetic prefix	3
Alphabetic suffix	3
Serial number	3

The entry defining Library of Congress card order number of the MARC file is *directly translatable* into LC/OC numbers. This is particularly important since it permits the direct transfer of data from the MARC file into BIBLIOS with LC card order number entries representing a subset of the LC/OC numbers available to BIBLIOS. In contrast, any entry defined within BIBLIOS for which a Library of Congress card order number is not established is identified by alpha characters in the year field: a factor, to be examined later, which permits the keys for such entries to be changed without losing the entry.

Fields contained within entries on the MARC file are captured on a temporary basis in fixed bibliographic format and listed. The lists, specifically, are a full display of all cumulated entries with author and title indices. By specifying the LC/OC number of particular MARC entries and their disposition, titles are selected for permanent capture in BIBLIOS, or deleted. To preclude an inordinate build-up of the MARC cumulative file, entries may also be deleted from the system "en masse" by exercising a "delete-by-date" option based on age of the entry.

The bibliographic subsystem captures and permanently maintains full bibliographic information on all entries within BIBLIOS. Input data for this function can originate either from manually prepared bibliographic information sheets or from MARC (as transmitted from the MARC subsystem).

The product of this function is the title master file, a relatively sophisticated file, organized into logical entries keyed to the LC/OC number. A maximum of 21 record types may be carried within an entry provided they contain significant (nonblank or nonzero) information. Nonsignificant records are not contained in an entry, a feature minimizing entry size and consequently file size.

The primary form for data input in the subsystem, the Bibliographic Information Sheet (BIS) shown in Fig. 1, is significant for several reasons:

To add a new entry or modify data previously entered, this form is used with only the pertinent data elements (in addition to document number, card ID, LC/OC number, and media code which must be present) being input.

The form is a field-by-field duplicate of format of the complete entry print layout of the master title list (Fig. 2, p. 82)



Mr. Norton is a member of the advisory staff at Century Information Sciences, where he specializes in the design and development of information processing systems. He has an ME from Stevens Institute of Technology and an MBA from Michigan State University.

to facilitate use and personnel training.

The form not only corresponds to the organization of the primary bibliographic data base—the Title Master File—but it also permits all data elements in each entry to be identified and, as required, contacted for correction.

Via the form, multiple changes to field(s) within an entry are permitted (other than LC/OC number) without restriction.

Of particular interest on the BIS, and master title file entry, are the following fields: The “on hand field” (AG) which shows that the entry has been verified against the book; the “sort author” (BA) and “sort title” (BB) which permits manual adjustment of the sequence into which the author or title would normally be forced by machine sorting; the “publisher code” (JF) which standardized the input of recurring publisher names; “bibliographic notes” (KD through KG) which permits frequently used bibliographic characteristics to be entered with minimum effort, and “information queries” (KH through KM) which allow the user to acknowledge and override those conditional data relationships within an entry that ordinarily would be treated as errors by the program processing the file.

The variety of data elements captured for any bibliographic entry is based upon the ultimate uses of this file. For BIBLIOS this means not only catalog production but also procurement and inventory control activities. To use the entire file in all these applications, however, would not be efficient. Therefore, relevant procurement data is extracted from the title master file and used to write a short title file.

The latter file contains only that bibliographic data on each entry required for acquisitions. Thus, for reorders, this data need not be re-entered.

Finally, the bibliographic subsystem permits changes from OC number keys (alpha date) to LC number keys (numeric date). In operation these entries are addressed, flagged for deletion and their contents copied onto a work file in conjunction with the applicable LC key (numeric date). Once all entries with OC number keys have been passed, the entries with LC number keys are written back onto the file. Deletion of the defunct duplicate entries with OC number keys is then effected.

Several displays are generated by the bibliographic subsystem upon user request. These displays consist of: the master title list (Fig. 2) presenting the full contents of all entries on the title master file in LC/OC number sequence, or a supplement containing only those entries modified or entered on the title master file since last title master list production; author and title indices to all entries on the title master file, a statistical recap of the master file contents; and a turnaround document displaying all entries available to the branches for ordering (available list). One copy of this list is reproduced for each branch. At the branch, copy requirements are noted on the list by the desired entry. Once marked, all lists are returned, and the branch number, copy requirement and the LC/OC number for each marked item are input to the procurement cycle.

The procurement subsystem performs all activities germane to the acquisition of library materials. In terms of

Orange County Public Library — Bibliographic Information Sheet

cycle id document no.

**F**

**A**  **B**  **C**  **D**  **E**  **F**  **G**  **H**  **I**  **J**  **K**  **L**  **M**  **N**  **O**  **P**

LC Year LC Sequence LC Prefix LC Suffix Serial Media On-Hand List Fiction Level Sub-Level Dewey-Pre Dewey Base Dewey Interpolation Cutter Limit

**A**  **B**

Sort Author Sort Title

**C**  **D**

Subject Role Author 1 Subject Role Author 2

**E**  **F**

Subject Role Author 3 Subject Title

**G**  **H**  **I**

Sub-Title Sub-Title Sub-Title

**J**  **K**  **L**  **M**  **N**  **O**  **P**  **Q**  **R**  **S**  **T**  **U**

Publication Year Copyright Year Pagination List Price Blind Publisher Code Publisher

**A**  **B**  **C**  **D**  **E**  **F**  **G**  **H**  **I**  **J**  **K**  **L**  **M**

Standard Book Number Review Source Core Bibliographic Notes Information Queries

**A**  **B**  **C**  **D**  **E**  **F**  **G**  **H**  **I**  **J**

Vendor 1 Disc Code Disc. % Net Price Proc. Vendor 2 Disc. Code Disc. % Net Price Proc.

**M**  **N**

Special Order Data 1 Special Order Data 2

**O**  **P**  **Q**  **R**  **S**

Annotation 1 Annotation 2 Annotation 3 Annotation 4

**S**  **T**  **U**

Series Series Title Subject Head 1 Subject Head 2

F6021-109

Fig. 1. Bibliographic Information Sheet.

system functions these are:

Accumulate requirements (number of copies to be ordered).

Generate ordering documents (the sub-purchase order).  
Process receipts.

In addition, and directly related to these functions, this subsystem maintains peripheral history files. Specifically, these are vendor performance and branch budget status files which contain both constants and dynamic statistical data generated as a by-product of subsystem operation.

In achieving the three functions outlined above, the procurement subsystem is divided functionally into five processing cycles:

- Pre-order/order cycle
- Receipt/cancellation cycle
- Invoice cycle
- Budget cycle
- Vendor cycle.

The highlights of each are detailed in the following paragraphs.

*Pre-order/order cycle.* This cycle performs two roles. The first, that of pre-order, forms a mechanism whereby temporary order data is captured for accumulation, display, and modification, as required, before processing into sub-purchase orders. The second role, order, receives corrected and verified data and actually produces sub-purchase orders in addition to updating history files related to the order process.

Three basic types of data are accepted into this dual cycle:

Bibliographic data describing the item desired, e.g., type of media (book, phonodisc, etc.), author, title, publisher, date.

Vendor data identifying the vendor and the contractual relationship maintained by him with the library for this specific item.

Requirement data identifying the branches or cost centers within the library ordering the item and the quantity each desires.

For bibliographic and vendor data, concerning those items previously entered into BIBLIOS or against which procurement activity is expected, there will already be an entry on the title master file. For those items, a shortened "procurement" version of that file, the short title file is available to the pre-order/order cycle. Thus only requirement data and the item's key need be specified to generate an order.

The short title file is not required for pre-order/order cycle operation as bibliographic, vendor and requirement data can be input independently—making this subsystem operable with, but not dependent on, the other modules of BIBLIOS. However, when items are received which were not

derived from the title master file, they will not go into inventory, as they are not on the short title file. Instead, they are listed as errors to trigger follow-up to insure that the inventory and bibliographic data bases are synchronized. This synchronization is required for circulation control and information (book) retrieval.

*Pre-order.* In its pre-order role, all data pertinent to the ordering process is captured, verified, and listed; but no orders are placed. Essentially, this mode can be considered a preliminary step which allows for human intervention to validate, correct, and otherwise modify data in the system.

Concurrent with manual "adjustment," pre-vend operation produces a tape file which serves to solicit bids from all participating vendors. Called the vendor bid request file, it forms a communication link whereby the availability and price on each desired item can be determined before an actual order is cut. And, to fulfill this communication function, all entries on it are broken into 80-position records so that most data transmission modes and devices now available will accommodate it without modification.

*Order.* In its order role, the procurement subsystem is used to modify data captured in the previous pre-order operation. All fields in each of three basic types of data (bibliographic, vendor, and requirement data) are accessible here and can be manually modified. In addition, items may be ordered by using the same procedures as those in the pre-order cycle.

Machine-readable vendor bid response files are honored for input at this point if available. These will be direct responses to the vendor bid request file produced in the previous pre-order cycle. If more than one vendor responds, BIBLIOS selects the vendor in terms of lowest price and availability of copies. Of importance is the vast improvement in procurement performance anticipated once vendors are capable of receiving, processing and responding to this mechanized bid approach.

The order cycle processes to an order (sub-purchase order) each entry retained in the system which is error-free, while entries with errors are retained and displayed for correction and future use.

Prior to being processed to order, each item desired will be assigned a unique sub-purchase order number as follows:

YYDDNNNC  
 where YY—is the Julian year of order  
 DDD—is the Julian day of order  
 NNNN—is a sequential number assigned during processing  
 C—is a mod 10 check digit derived arithmetically from the date and sequential number integers.

This number is both date explicit for machine aging and

LB20F501	MASTER TITLE LIST	ORANGE COUNTY PUBLIC LIBRARY	12/01/69	PAGE 487
79084136.....	CONTINUED			
	C. N 3 LEWIS, RICHARD			
	F. N MUSE OF THE ROUND SKY			
	G. LYRIC POETRY OF ANCIENT GREECE			
	J. A-1969 B-	C- 96P D-00004.29	E-C F-SHM G-SIMON-SCHUSTER	
	K. A-	B-***BBG9-141	C- D-22 E-	F- I- G-
	L. A-LEI B-C C-	D-	E- F-SA G-C H-	I- J- K- L- M-
79084885.....				
**NEW**	A. A-79 B-084885 C-	D- E- F-01 G-	H-A I-N J-A K-	L- M- N- O- P- Q- R- S- T- U- V- W- X- Y- Z-
	C. N 1 WOOD, CHARLES			
	F. N DINGO			
	J. A-1969 B-	C- 96P D-00001.95	E-F F-GROV G-GROVE PRESS	
	K. A-	B-LJ11-1=4022	C- D- E-	F- I- G-
	L. A-SG B-G C-	D-	E- F-XYZ G-G H-	I- J- K- L- M-
79085046.....				
	WAS A. A-79 B-085046 C-	D- E- F-01 G-	H-A I-N J-A K-	L- M- N- O- P- Q- R- S- T- U- V- W- X- Y- Z-
	IS A. A-79 B-085046 C-	D- E- F-01 G-	H-A I-N J-A K-	L- M- N- O- P- Q- R- S- T- U- V- W- X- Y- Z-
	C. N 3 WALLIS, CHARLES L.			

Fig. 2. Sample of Master Title List.

uniquely identifies the item until all procurement processes are complete. At the time of sub-purchase order production, statistical data is selected from them and generated onto the vendor file and budget history file as encumbrances. In addition, the order cycle produces sub-purchase orders to communicate and document each order transaction per item per vendor; a receiving and distribution list presenting all items awaiting receipt to receive and route new materials; a cumulative on-order list, containing all items due into the library system to preclude erroneous re-orders; and the branch on-order lists reporting items each branch has on order.

At the vendor's option, ordering can be effected via a sub-purchase order file generated onto tape at this point for transmission to him.

#### *Receipt/cancellation cycle.*

This cycle is concerned with the disposition of active sub-purchase orders. Receipts and cancellations are processed into the cycle by sub-purchase order number.

Receipts are:

Processed onto the inventory update file for future inventory accumulation.

Copied onto the invoice suspense update file for later assignment of actual cost.

Both automatic (by aging) and manual cancellations are handled by BIBLIOS in the following manner:

If an alternate vendor was assigned at the time the sub-purchase order was originally placed, the entry is automatically re-ordered in the next pre-order/order cycle.

If no alternate vendor was assigned, the sub-purchase order is terminated.

In either case, cancellations are copied onto the invoice suspense update file for future processing.

The reporting function of the receipt/cancellation cycle is fulfilled through branch cancel/receipt lists reflecting all items canceled (not to be re-ordered) and received during the current processing cycle by branch; headquarters (overall) receipts and cancellation lists; cancellation notices addressed to the affected vendors and designed for direct mailing; and a pending cancellation list of all sub-purchase orders to be canceled automatically if the contractually arranged aging period is not extended.

*Invoice cycle.* Here the net paid price for received sub-purchase orders is assigned and received sub-purchase orders which are awaiting price assignment are accumulated. This allows inventory-related activities to be performed independently of accounting functions by accommodating the timing differences between them.

On assignment of the actual price (or the cancellation of an item) a transaction is prepared to update statistics maintained on the vendor and budget history files.

### **inventory subsystem**

The inventory subsystem maintains an accurate accounting of library materials in the library system. Control is maintained to the operational category level within each branch, e.g., adult and juvenile. There are two sources of input:

Receipts processed from the procurement cycle.

Manual input for gift receipts, losses and interbranch reassignments.

To ensure the integrity of the inventory master file, entries on the short title file, representing all items for which permanent bibliographic data has been captured, are permitted to interact with the inventory master file. This automatically eliminates special one-time orders coming from the procurement cycle and, as indicated earlier, keeps

inventory in step with the catalog data maintained in the bibliographic subsystem.

The primary lists generated in this subsystem are:

The inventory master list, which contains in LC/OC number sequence the full contents of the inventory master file.

The inventory supplement list, which contains in LC/OC number sequence the status of all entries altered since the last inventory master list.

Of note is the maintenance here of an accurate inventory master file which will be used for the circulation control cycle now in design.

### **special reports subsystem**

This subsystem generates collection profiles (graphs) predicated on the characteristics of each entry in the system. Bibliographic data from the short title file, and inventory data from the inventory master file, are used for this function. Selection criteria is predicated upon search parameters entered with each execution of the subsystem. Examples of this criteria are:

Number of titles within any or all Dewey class numbers in the range 001 through 999 in each branch as well as in the entire system.

Number of copies within any or all Dewey class numbers in the range 001 through 999 in each branch as well as in the entire system.

Or with greater specificity:

Number of copies within Dewey class number 865 which are later than 1965 for juveniles only in each branch and in the entire system.

This technique lends itself to a steering function for collection development and can be used for direct comparison, either manually or mechanically, with similar statistical data developed for each community served. This latter feature will be incorporated into BIBLIOS once the circulation control cycle of the inventory subsystem is implemented.

### **projected branch subsystem**

The purpose of the projected branch subsystem is to allow the library system to plan for future branches. The operation of this subsystem is similar to that for the pre-order portion of the pre-order/order cycle of the procurement subsystem where all required bibliographic data and vendor data are on the short title file. Requirements data is prepared on cards and stored in the same format prescribed for requirements data in the pre-order/order cycle. These requirements are accumulated manually by (proposed) branch and periodically presented to the projected branch subsystem for processing.

As new branches are activated, the accumulation of requirements for the proposed branch are transferred in bulk to the pre-order/order cycle of the procurement subsystem where they are handled like all other requirements data being processed for procurement.

### **future plans**

BIBLIOS represents the second edp endeavor by the Orange County Public Library. The original system was designed to aid in procurement processing alone. BIBLIOS, benefitting from past experience, expands the scope of processing to include other areas as well as procurement on a modular basis.

Future modules include circulation control and book catalog production, the latter now in development and scheduled for completion in July, 1970. ■



# The unrehearsed Keytape\* Demonstration.

On land, on the sea, or in the air,  
we'd like to prove that Keytape  
units work as well as we say they  
do. By showing them in action.  
Live. (Without a lot of technicians  
standing by to make sure every-  
thing goes smoothly.)  
Look closely.

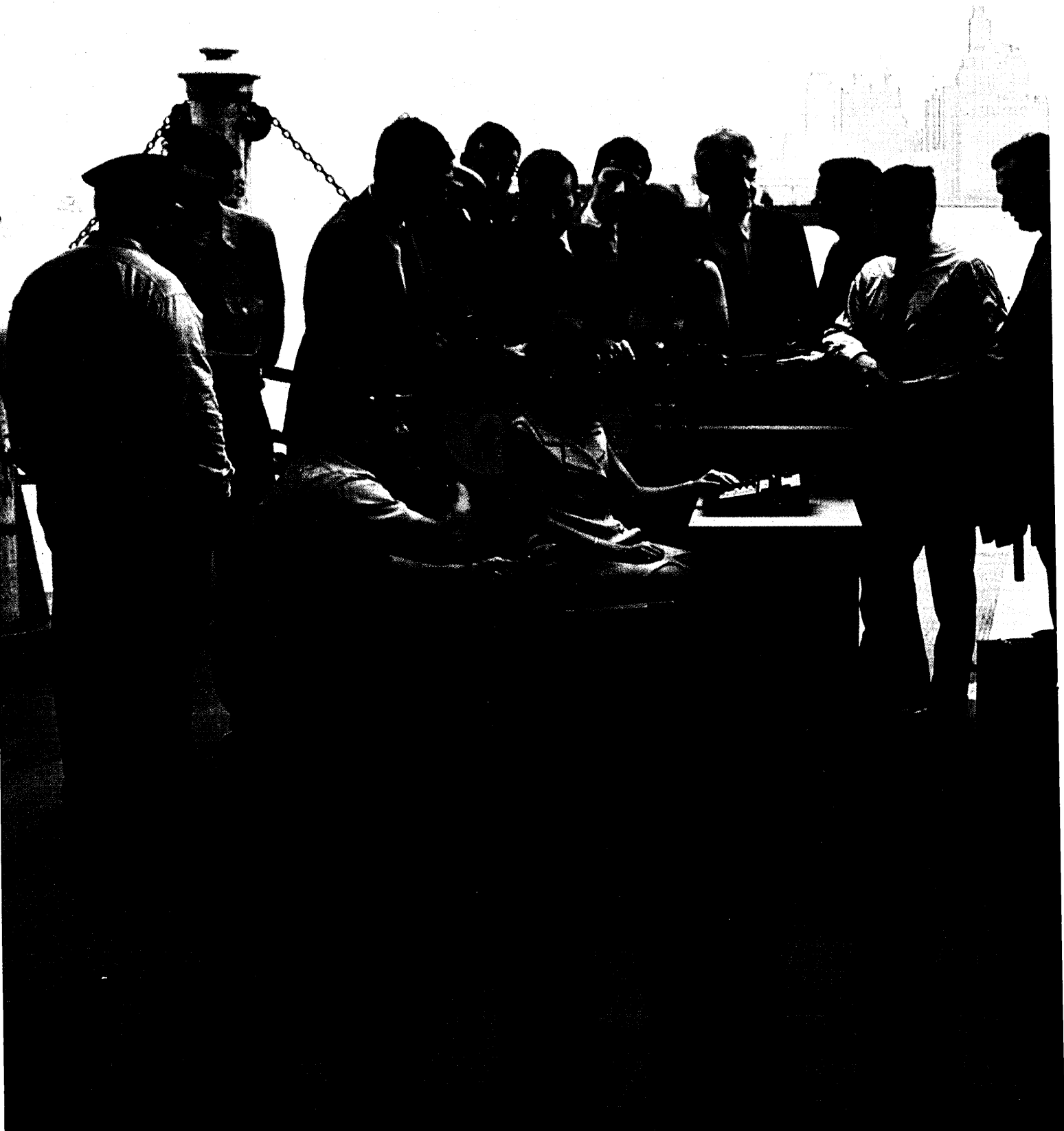

See Keytape communicate,  
validate check digits, add, list, or  
pool.

Watch the way Keytape prints  
out hard copy records.

Sure, other companies advertise  
devices that solve many of these  
data preparation problems.

But we have them in operation.  
Now.

Which is the difference between  
an act and a performance.

If that's your kind of show, give  
us a call.

We'd like to audition for you.

\*Trademark of Honeywell Inc.

The Other Computer Company:

**Honeywell**



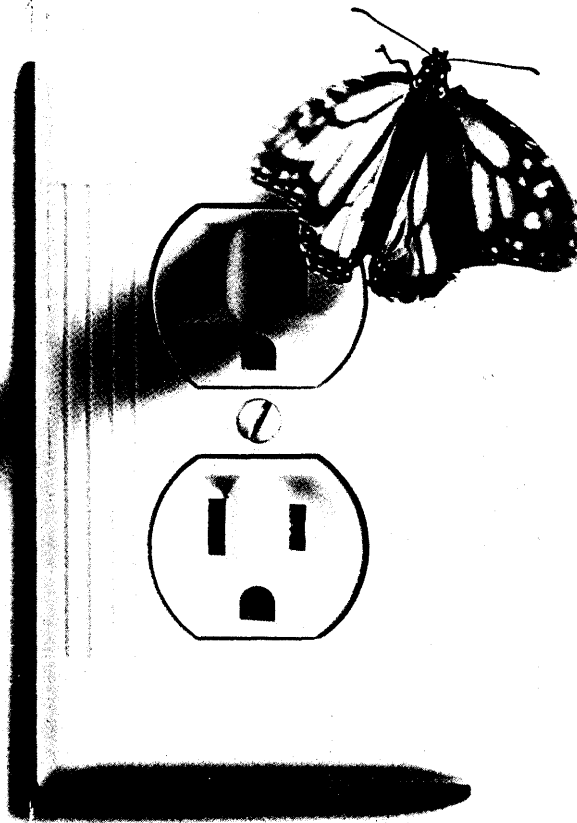

## (Computer Killer)

Innocent looking isn't it?

That harmless looking wall plug can erase or even physically destroy your computer's memory or other critical components.

Your computer could be its next victim. Minute transients on the line as the electric company changes its output to meet load variation, power surges, spikes and dips from lightning storms, complete power outages due to cut cables, downed power lines,

insulator failures, and the like...are all problems the electric company has little control over. You can wind up with a hunk of expensive scrap from just a few milliseconds loss of power when your computer-controlled machine tool zags instead of zigs. If that innocent looking wall plug goes "dead" at all, you are out of business.

It's easy to guard your computer from the Killer. Run the power cord through an Avtel UPS (Uninterruptible Power System). This solid-state watchman quietly protects your computer by smoothing out the peaks, dips, and spikes. It continues to supply all the power your computer needs

when the electric company can't. From a microsecond to several hours. *Nice, clean, uninterruptible power* is all that ever reaches your computer.

Send for our complete story. Models from 250 VA to more than a million VA. Twenty-six (26) options.

Take another look at that wall plug. Still look innocent?



**AVTEL**

Avtel Corporation  
Division of Airtronics, Inc.  
1130 E. Cypress Street  
Covina, California 91722  
Telephone (213) 331-0661

# A REGIONAL NETWORK—OHIO COLLEGE LIBRARY CENTER

on campus

by Frederick G. Kilgour

The Ohio College Library Center is developing a computerized, user-oriented, library system that will improve efficiency of library use and operations; that will increase availability of library resources within a region; and that will facilitate evolution of new and easier accesses to information in libraries. The center does not conceive of its task as being merely the mechanization of library procedures of the past.

For the immediate future, the principal academic objective of the center is to increase the availability of library resources for use in educational and research programs in colleges and universities throughout Ohio. A more distant objective is to enable libraries to participate actively in the programs of instruction and research in their institutions. The passive service functions that libraries have developed during the past century are proving inadequate to meet the present demands made of libraries, and will be increasingly inadequate in the future.

The per-student costs of libraries are rising somewhat more than twice as rapidly as unit-cost rises in the general economy. Therefore, the principal economic goal of the Ohio College Library Center is to decelerate the rate of rise of per-student costs, so that the rate of increase will approximate that of the economy as a whole.

Library procedures are presently manual procedures. Only the introduction of an increasingly productive library technology can reduce the rate of rising costs. Here the only apparent, fruitful avenue of technology is that of the computer employed as an information processing machine. However, fewer than a half-dozen libraries possess a computer dedicated to library operations, and, with but one exception (the xds Sigma 7 at the University of Toronto) these machines are medium-sized with restricted computing power. Such equipment can achieve little more

than mechanization of existing manual, internal library procedures, much in the manner of most data processing applications. Moreover, the vast majority of libraries have neither funds nor manpower adequate to support the most humble of computer installations.

The Ohio College Library Center, therefore, is developing as a central computer utility, to supply adequate computer power plus bibliographic and indexing information to member libraries that can employ such power and information in accord with their individual needs and financial resources. At the present there are 54 members—all academic libraries, both state and private.



Mr. Kilgour has been director of the Ohio College Library Center since 1967. Previous to this he was associate librarian for R & D at the Yale University Library, and librarian of the Yale Medical Library. Since 1968 he has been editor of the *Journal of Library Automation* and has been involved in three books and numerous articles. He has a BA in chemistry from Harvard.

The Ohio College Library Center is a not-for-profit corporation chartered by the state of Ohio. Its members are Ohio colleges and universities that, at the present time, pay to the center an assessment based on the number of books that each member library adds to its collection during the previous year. Each member institution appoints a representative to the center, and the representatives elect from their group nine trustees (three each year for three-year terms) whose responsibility and authority are the same as those which most corporate trustees possess. The Ohio State University has generously made available space to house the center's operations.

Activities of the center are research, development, implementation, and operation of computerized systems to achieve the center's academic objectives and economic goals. Although relatively little time is expended on research, most of which is separately funded, there is a great need for research activity to produce the knowledge necessary to develop regional library systems. The center is currently in the early weeks of operation of an off-line catalog production system, and plans to bring into operation in the summer of 1971 a shared cataloging system that will be the first of five major on-line subsystems.

The on-line shared cataloging system will be based on a central computerized catalog that will also form the data base of the other four subsystems. Shared cataloging will speed the cataloging process and reduce cataloging costs in member libraries: (1) by taking advantage of cataloging performed elsewhere and thereby eliminating duplicate effort; and (2) by employment of labor-saving machines. In addition, this subsystem will include, at no extra cost, a central union catalog whereby each member can rapidly determine by author and title the location of materials throughout Ohio.

The second project will be an on-line remote catalog access and circulation control system, which will enable faculty and students, while outside the library, to check local institution holdings as well as holdings throughout the state. Access to this system will be by author and title, as well as by call number of a book. This system will inform the user of the location of the item desired, and whether or not the item is immediately available for him, before he leaves the building in which he is working or studying and from which he generated his inquiry. This system will greatly reduce user costs, which must be included in library system costs, as well as cut costs to libraries for circulation control.

The Ohio State University libraries have signed a contract with IBM to design and activate a remote catalog access and circulation control system that will be similar to the center's subsystem. It is the intent of OSU that its system design will be such that the center will be able to take advantage of it by adapting at least modules, if not the entire design.

The third system will be a retrieval project that will enable users at remote terminals to search the central catalog by subject, by title alone, by any author (should there be multiple authors), and by editors. This system will be capable of carrying out searches using post-coordination of subject words, title words, and names.

The fourth project is a serials (periodicals, annuals, year-books, etc.) control system that will facilitate library control of serials holdings, and user access to these detailed records.

The fifth subsystem will be a major library technical processing system that will computerize most of the library acquisitions and catalog-processing activity. One of this system's major products will be the addition to the central catalog of materials *in process* so that a user can determine

the existence and location of a specific book in a library system before complete entry in a catalog has been accomplished.

As is the case with all on-line computer utilities, the most critical characteristic to be designed into the system is reliability of performance. For the present and foreseeable future, it appears that the only design that provides a comfortable measure of reliability is that which includes redundancy of major components. Fig. 1 presents a generalized design of the system that the center will employ. When such a system possesses highly reliable components the system will perform adequately for the center's purposes. However, the major question concerning the components is, "What characteristics must the components possess to carry out efficiently the tasks with which they will be burdened?" Attempts to answer this question produced a mass of information on characteristics of various models of various ma-

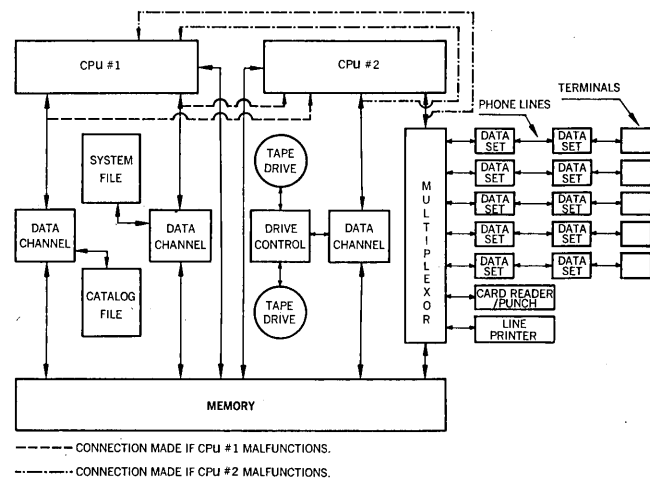

Fig. 1 Ohio College Library Center equipment and communications system.

chines from various manufacturers, and a paucity of data on the character-manipulative characteristics of the same equipment. Moreover, it was not possible to deduce from general characteristics the character-manipulative performance of any computer system, since no computer system, together with its operating system, has been designed to carry out character manipulation. This duality of too much and too little information forced the decision of whether equipment would be selected on the basis of a masqueraded guess or a computerized simulation. Simulation was chosen.

The center requested a matching grant from the Library Services and Construction Act, Title III, Special Project Grant Funds (administered by the Ohio State Library), and subsequently the Board of the State Library approved a grant in the amount of \$18,588. Compress, Inc., was selected to perform the simulation and, prior to the three-month period in which the simulation was carried out, requests for computer systems proposals went to 10 computer manufacturers. The request was based on the design in Fig. 1 which required that the system operate on one cpu at peak loading (an average of five requests per second over the period of an hour). On the first challenge by the simulation, all 10 proposals failed because of inefficiencies in their operating systems. The center and the Compress staff then proposed a modification of the operating systems,

which the manufacturers accepted, with the result that three of the systems proposed performed adequately.

Next, the center staff undertook a trade-off study on the three successful systems, which included such characteristics as reliability, simplicity, time to install the application systems, and cost. As a result, the center has selected a Xerox Data Systems Sigma 5 computer.

The Office of Education awarded the Ohio College Library Center a grant in the amount of \$90,135, largely for personnel to undertake development, beginning Jan. 1, 1970. Work on the first major on-line project, the shared cataloging system, is now under way.

### the huge file problem

The detailed system design and simulation revealed that the major gap in knowledge for the implementation of the Ohio College Library Center on-line design is efficient organization and operation of a huge file. The simulation was carried out at a seven-year level of operation, when peak loading would be at 18,000 requests an hour. These 18,000 requests will generate over 60,000 seeks in a file that houses indexes, and six million bibliographic records averaging 554 characters in length. The center has received a contract from the National Agricultural Library to support such research, and results of the first series of experiments will soon be available. Investigators at the Bell Telephone Laboratories, Inforonics, Inc., and Rice, Stanford, and Washington State Universities have been engaged in research and development on similar facets of the huge file problem.

In early April, 1969, the MARC (MACHINE Readable Cataloging) Distribution Service of the Library of Congress began to make available LC cataloging of books printed in the United States. These MARC records on tapes made feasible early activation of a batch off-line shared cataloging procedure. The Ohio College Library Center developed a similar system, which became operational at the turn of the year. The system does much of the cataloging for current American books acquired by member libraries which are members. The center furnishes these libraries with catalog cards in final form, alphabetized for filing in specific member catalogs. The procedure also converts current cataloging by members to machine-readable form by the simple device of recording holdings and respective call numbers on the MARC record. This MARC file, bearing member holdings, will be located in the center and will form the basic catalog file at the time the shared cataloging project is implemented.

### system appraisal

The simulation study demonstrated that the Ohio College Library Center regional library system will operate efficiently and economically on available equipment. Simulation was performed at a seven-year level, but it is believed that obsolescence will not occur in less than a decade after implementation. Only the wearing out of the machine, or the job performed by the machine, yields obsolescence. There appears to be no existing data that would suggest that the initial computer system would be obsolete in less than a decade. It is possible that one of the jobs, namely manual descriptive cataloging, might become obsolescent during the decade, for it might be replaced by mechanized descriptive cataloging. A mechanized cataloging technique was simulated, and it was found that the system chosen could handle the task with somewhat less percent utilization of the cpu.

The system is designed to be evolutionary and on-line, although its first implementation is an off-line batch pro-

cessing of cataloging production. The system is based on standards, but not uniformity of product. For example, each member library can specify its own format for different types of catalog cards; it need not accept a format imposed by uniformity.

Cards produced by the Catalog Production System cost 9.5 cents each—about half the cost of catalog cards ready for filing in specific catalogs when produced by most, but not all, manual procedures. Early estimates of the costs of shared cataloging show that from the very small to the very large libraries there will be demonstrable savings. Indeed, these savings will be of such magnitude as to enable members to amortize four years of assessments in one to three years. These four years represent years of research, system design, and implementation. The system therefore would be viable if only the shared cataloging project were to be implemented.

It is hoped that the Ohio College Library Center Regional Library System will be a prototype node in a national network. However, as soon as three or more nodes exist, it will be necessary to establish some national library authority to manage the network, particularly the switching of messages among nodes. To date, the Ohio College Library Center has done no specific system design for such a network, but its adherence to national standards will facilitate national implementation when nodes become operational in other regions. ■



"She's charming, witty and attractive, dear,  
but can she program?"

© DATAMATION®



# THIS IS A COMPUTER?



## YOU BET YOUR SWEET TELEX OPERATOR IT IS!

Beneath that Telex keyboard is a full-fledged 16-bit word-length digital computer with the most powerful I/O structure available today. It's the DATACOMP 404.

Hardware decimal arithmetic, including multiply and divide with automatic scaling, eliminates binary/decimal conversion. On I/O automatic formatting eliminates expensive editing software.

Word-length operating modes that are built into the 404's hardware can be programmed for 16, 32, 48, or 64 bits, doing away with multi-precision routines.

Sixteen addressing modes, including double-index and relative, hardware-streamline the most complicated routines and permit you to relocate object programs.

The 404 executive hardware time shares its own terminals while acting as the INTELLIGENT TERMINAL in a time-shared network.

If you're an OEM and you're thinking of force-feeding a binary bit-switcher to solve decimal problems, Telex us before you make a sad mistake. The 404 starts at \$6800.

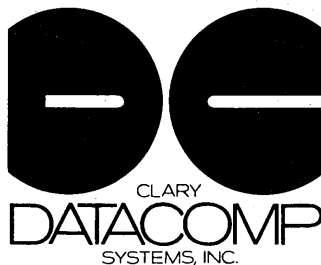

404 Junipero Serra Drive, San Gabriel, California 91776  
Telephone: (213) 283-9485/Telex: 67-4604

# LET THE COMPUTER SELECT YOUR READING LIST

by John R. Jordan

The need for computerized information systems has been well documented. This paper will show how one information system is fulfilling this need at a low cost.

The Ames SDR-kwoc Index\* (Selective Dissemination of Information—Key Word Out of Context) system is an information system which scans 4,000 current titles weekly, notifying each user of documents in which he may be interested. Quarterly, a kwoc Index of those document titles which he has selected as relevant during the quarter is prepared automatically and sent to him. This system has been serving AEC scientists at the Ames Laboratory of Iowa State University since 1964. Recently it has been made available to the Iowa State staff-at-large and to any interested outside parties including industries and other universities.

There are two forms of output from the system. The most basic is the notification concerning a document which the system judges to be of interest to the user (Fig. 1, p. 92). Such notifications are printed on two-part cards. The information which describes the document is contained on the left-hand portion. The right-hand portion is the means for the user to communicate with the system. Its function will be discussed later. The pertinent portions of the notification include the authors of the document, the document's title, and its source.

The kwoc index, the other portion of the output, is automatically prepared quarterly by the system. The bibliography contains all those citations which, during the quarter, the user indicated as being relevant. This index organizes the output in a more usable fashion and allows a user to review those citations he has accumulated.

The key word index lists the documents in order of the key words. The user merely scans the key word portion for the word of interest. The first 100 characters of the title are

shown for him to read. If he wants to know where he may get the document, he uses the reference number shown at the left to locate the entry in the bibliography. Alternatively, if he is interested in finding something by a particular author, there is an author index showing all reference numbers of documents by each author.

The first major input is called a user interest profile and is his primary means of communicating with the system. This interest profile is composed of terms which the user feels describe his interests. These terms may be entered in the profile in a variety of ways. Briefly, these amount to PREFIX<sup>1</sup>, SUFFIX and EXACT MATCHES, WORD GROUPS, and NEGATION. An entry in the profile, whether it is a word, group of words, etc., is called a descriptor. Thus a profile is composed of descriptors, each descriptor being of any of the above forms.

The other major input is the tape containing the document titles against which the profiles are matched. This is purchased from a vendor<sup>2</sup> and processed on a weekly cycle. *(Continued on p. 92)*



Mr. Jordan is a systems analyst for the Ames Laboratory of the USAEC at Iowa State University. He formerly was an edp analyst with the Boeing Co., Seattle. He has a BS in math from Iowa State University and is presently working towards his MS in computer science.

\* Work was performed in the Ames Laboratory of the U.S. Atomic Energy Commission. Contribution No. 2670.

<sup>1</sup> Prefix and suffix in this context mean a substring of the left or right ends of a word, respectively.

<sup>2</sup> Presently this vendor is PANDEX of CCM Information Sciences, Inc., New York, N.Y. The first experiments were conducted using tapes from *Nuclear Science Abstracts* and the Institute for Scientific Information (ISI), Philadelphia, Pa. ISI's tape was used from 1964 until September, 1969.

A schematic diagram of the system is shown in Fig. 2. Depicted at the top is the vendor's transcription of the documents to the tape. The user is shown as entering his interest profile. The document tape is then matched against all of the user's profiles (in one pass via sorting). This matching process generates the notifications which are sent to the user who examines them, checks the appropriate response (see response portion of Fig. 1), and returns the right-hand portion to the system. The response is used for three purposes. The first is to update his interest profile (see system performance section). The second is to cause the associated citation (which the system has retained) to be transferred to a file which will be indexed when 12 weeks have elapsed. The third is to tabulate statistics on system performance.

**cost of the system**

A typical group cost distribution for one month is shown in Fig. 3. Although the average cost per user per year is \$144, due to the skewness of the distribution, half are getting by for less than \$126 per year. This is a very encouraging aspect, because regardless of the shape of the distribution, as will be explained later, we will recover the costs. This means that a small user is not penalized by a large user, a factor which is often overlooked when simple averages are quoted. We have essentially four distinct user groups, and this distribution is representative of all of them.

The price formula is  $P = A * (T + B * W + C * N)$ , where T is the distributed purchase price of the tape, W is the number of profile words, and N is the number of notifications received in a given billing period. A is the overhead and margin for error markup factor. The cost of the tape is distributed over a projected user group of 500. Pricing is something less than an exact science, especially in a time-shared computer system. However, we have tried to be just in assessing the actual costs of the resources used, by developing a formula which equitably distributes these costs and keeps us from going under. Some systems which

offer similar services charge only on the basis of profile word frequency, since high frequency words will cause more notifications to be generated than low frequency words. However, this approach is costly to administer and does not (in our system) account sufficiently for the variance. In our system there is a high correlation between profile size and the major cost—computer time. Therefore, most computer costs are assessed on the profile size. The one exception to this rule is the kwoc Index. Although it is related directly to the number of notifications, it only accounts for 5% of the total computer costs and therefore, without too much strain, can be lumped in with the other computer costs. The notification charge, which is linear with the number of notifications, covers the cost of printing, stationery (cards), and postage. Due to the high correlation between the actual costs and the charges, we have a tight control on the product and are protected from going under on a very slim markup factor.

Recently one of our larger user companies (Mound Laboratory of the Monsanto Research Corp., Miamisburg, Ohio) conducted a cost-savings study of our system. They found, on the average, each user was saving three hours per week in literature-searching activities. Using an hourly rate of \$7 per hour, this figures out to be a savings of approximately \$1,000 per year per man. The cost of the system per man for one year is approximately \$250. This then represents a 400% return on the investment in time savings alone. This does not take into account that each user, on the average, is aware of three times as many pertinent articles as he was when relying on previous methods of literature searching.

We do not offer reprints of articles as a part of our service but rely on libraries available to users. We have had the opportunity to observe the effect this system has had on four company or laboratory libraries. In all cases, the results were identical—business *tripled*. Of course this represents a substantial cost increase to the libraries. However, since libraries do have a large overhead cost, tripling the business decreases the unit cost of their activities. It is obvious there was a need for expanded service, which was not being

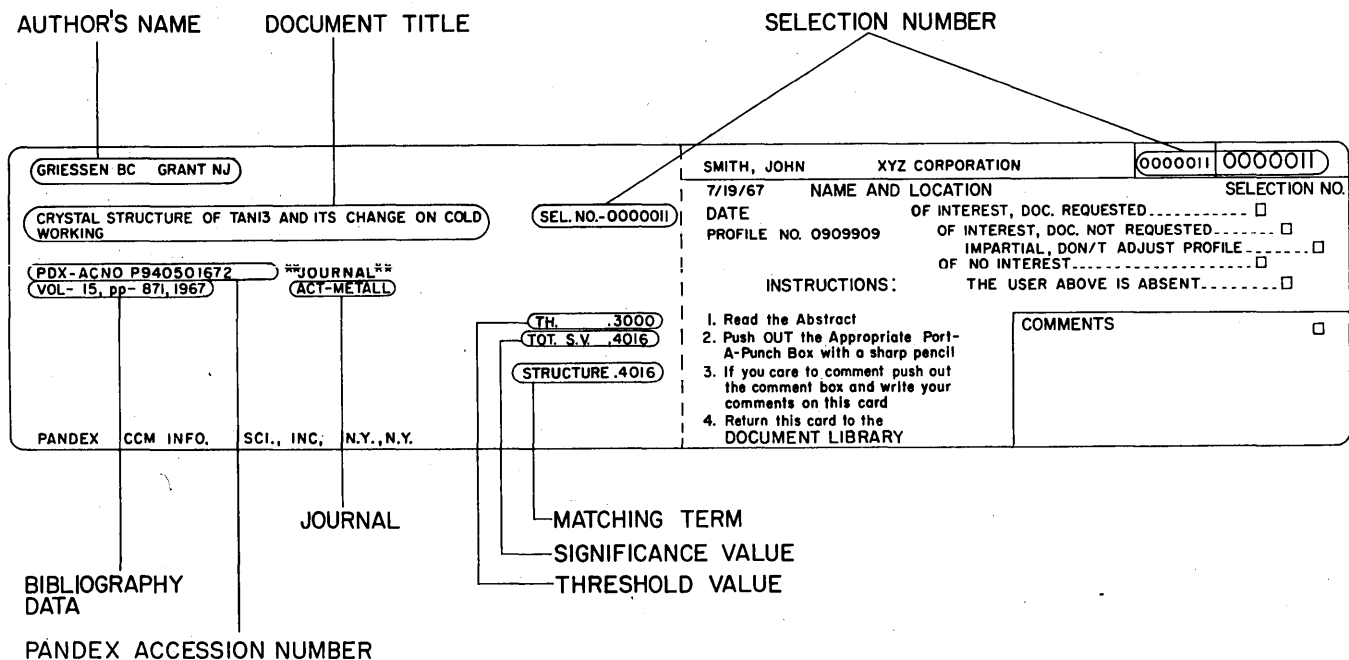

Fig. 1. Example of the notification.

offered without the help of the computer. Researchers simply were not aware of the existence of this abundance of pertinent literature. It's a case of what you don't know *will* hurt you! The machine has helped users to maximize the benefits derivable from their library services.

Before proceeding to discuss the merits of this system, it will be instructive to examine its purposes and to look at the problems it has in accomplishing its goals.

In an information system of this nature, two goals are sought. The first is to maximize the amount of pertinent current literature made available to each user. I would like to stress the word *current*. This type of endeavor is different in concept and in fact from aiding one in a literature search of past material. That function (retrospective searching) very naturally follows from an SDI function since, in the process of providing a current awareness service, a substantial file of past citations is accumulated. We estimate that

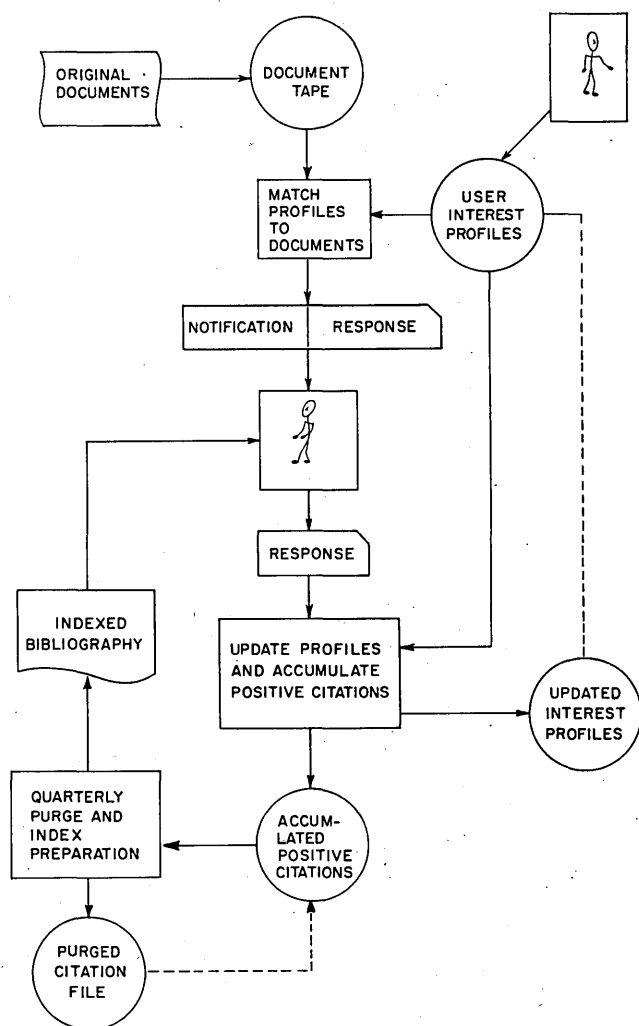

Fig. 2. Schematic of the Ames SDI-KWOC Index system.

since we began operations in 1964 we have accumulated nearly two million titles which are available for retrospective searching.

The second goal is to minimize the time spent by each user in keeping abreast of current developments and thus to free him to carry on his work. It has been estimated that a scientist or engineer spends from 10% to 20% of his time in literature-searching activities. If we can save a substantial

portion of that time, we will have created a lot of production time. So, briefly, the goals are to maximize the amount of information available to a user and to minimize the expenditure of his time. These goals are to be accomplished at a minimum cost.

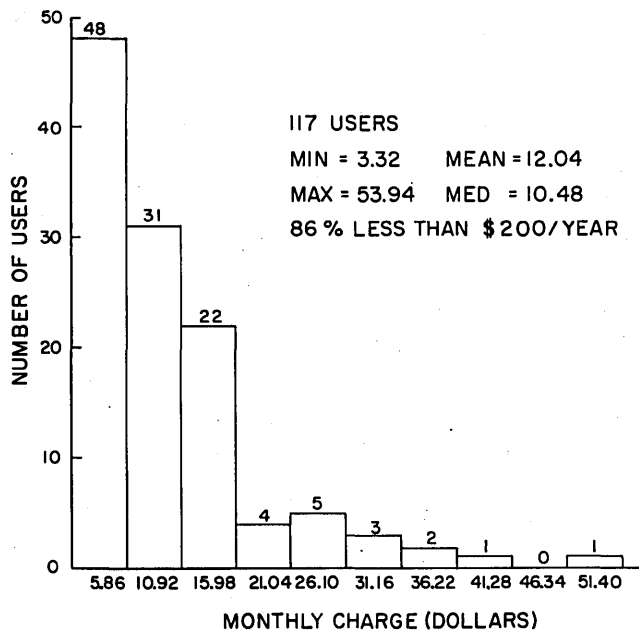

Fig. 3. Cost Distributions.

The relative success or failure in accomplishing the above goals can be depicted graphically (Fig. 4, p. 94). The sum of all the numbers in the cells is the number of documents which enter the system. The top row (H + T) is the number of documents sent to the user, and therefore the bottom row is the number not sent to him. The left-hand column (H + M) is the number of documents in the system which are relevant to the user, and the right-hand column (T + P), of course, is the number of documents which are irrelevant. Thus T represents those documents which the user received but did not want, and M represents those which he did not receive but should have. These are measures of system error and, hence, it is desirable to minimize them. It should be noted that there is a lower bound imposed on the type of error associated with M, which is caused by the omission of pertinent documents from the system. We, of course, assume responsibility from a systems standpoint of overlooking only those documents which the vendor has supplied.

You will recall that interest profiles are made up of descriptors. Associated with each descriptor is either a weight which ranges between 0 and 1 or a negative flag. When one or more descriptors in a given profile matches terms in a title, the sum<sup>3</sup> of these weights is computed and compared with a threshold value. If this sum is equal to or exceeds the threshold value, a notification is generated. If a word in the title matches a negated word in the profile, this title will not become a notification. You will recall that the notification has two parts—one containing the citation and the other for responding to the system. The user checks the appropriate response (positive, negative, or neutral) and returns the card to the system. This response is fed into the system and, depending on the response, the weight asso-

<sup>3</sup> This sum is that of the probability of the union of events, i.e.,  $S = A + B - AB, 0 \leq A, B \leq 1$  implies  $0 \leq S \leq 1$ .

ciated with the descriptor(s) which generated the notification is increased, decreased, or left alone. Roughly, if a descriptor receives more negative responses than positive, its weight falls below the threshold. The only way it can then cause a notification to be generated is to combine with other descriptors, or to wait for a built-in function to gradually raise its weight to the threshold value. In this manner the system automatically reduces the T error by distribution of those notifications over P and (sad to say) some H over M.

What about the M error? It can be caused by any of several things, two of which include failure of the user to include in his profile descriptors which would match with the document, and failure of the title to contain words descriptive of the document's content. The question is where to put money to try to reduce this error. Let us look at the relative numbers in these cells. For our system, the numbers shown in Fig. 4 (b) are fairly representative of a typical user who does not care either to receive or to see

RELEVANT DOCUMENTS	IRRELEVANT DOCUMENTS	
H	T	NOTIFICATIONS RECEIVED
M	P	NOTIFICATIONS NOT RECEIVED

A

0.14%	0.19%	0.33%
0.05%*	99.62%*	99.67%
0.19%	99.81%	

B

\* ESTIMATED PERCENTAGES  
Fig. 4 (a and b). Contingency tables.

over 99% of the documents. Thus, most of the time and money spent indexing all of these documents (plus the added cost of computer processing time) is going to be wasted. The best answer to this problem is to attach the abstract (if available) to the document when it is prepared for the tape. This serves two purposes: it adds meaningful terms (author-supplied indexing) on which to match; and it also provides the user with added discriminating power when he receives the notification.

Our system is capable of accepting and processing abstracts, index terms, or full text, for that matter. In fact, when the first experiments (covering 26 weeks of input) were conducted to determine the feasibility of this en-

deavor, one of the inputs was a tape containing abstracts. A survey of the pilot users was conducted which showed that, although the abstracts did have merit, they were not worth the additional cost.

But to return to the problem of where to spend money in eliminating the M error, it is clear that effort is best spent on constructing good profiles in the first place. We have observed that users who put in the most effort in constructing a profile do derive the best results and are most satisfied with the system.

**efforts to improve system performance**

We have conducted some experiments in automatic profile enriching in an effort to reduce the M error. The results were at the same time rewarding and discouraging since they achieved (in some cases) the doubling of the number of relevant documents, but at an increase in cost as well as in the T error. We are experimenting with some of the techniques using a thesaurus to aid the user in the construction of his profile. There is a danger of adding terms to a person's profile without his consent; that is, increasing his output and costs without his approval. This approach is clearly not feasible with paying customers unless it is nearly infallible—a condition which does not seem likely to happen. However, giving the user both assistance at the beginning in constructing the profile, and an opportunity to inspect an expanded profile before it is actually put into use, seems a viable solution.

One fundamental difference between this system and traditional means of dissemination of this type of information is the *personalized service*. That is, users are not put on a list with others who share similar interests unless they choose to be. Each person receives a set of notifications which are tailored to his individual needs. This avoids or minimizes the time required to scan material which would be interesting to his colleagues but not to him.

Deviations from this occur when several users get together in order to beat the fixed-profile charge, or when a team is interested in a common area. In the former case, experience has shown this to be unsatisfactory because of problems in coordination and easy maintenance of reference files. In the second case, it proves to be profitable to have a group profile because each group member is interested in a common area. Duplication is avoided and, most importantly, members can share in the development of a comprehensive profile by pooling their ideas concerning which words should be included. This we have found to be more common in the industrial users than in the university setting; since in an industrial situation teams work together on projects, but in a university there is much more individual effort. However, a professor with several graduate students working in the same area may be interested in the group profile alternative.

**tomorrow**

Given today's means of communicating research results, SDI is currently the most effective means of coping with the increasing volume of literature. Although the actual cash outlay is not small, the benefits derived for those who need the information far exceed the cost. We look forward to the day when (as some predict) computing costs are reduced by a factor of 200. If this happens, it will put SDI within the reach of everyone—and indeed they will not be able to do without it. Also, at that time it will be possible to think in terms of more advanced systems—such as using SDI as the nucleus of a system which would employ photo-composition techniques to produce for each user his personal journal, instead of telling him where to find relevant articles. ■

Practically prodigious is the Interdata family of computers now available with our unique Mass Core Memory. *It's Practical:* For the first time low cost Mass Memory is available with a powerful 3rd generation computer for those jobs requiring large core resident programs. This offers you greater reliabil-

ity and operating simplicity than any comparable peripheral storage unit. *It's Prodigious:* Teamed with an Interdata General Purpose or Communications Processor you have 65K *directly addressable* bytes of memory, over 75 standard instructions, 16 general registers, a host of options and lots of Firm-

ware. In addition, the full Interdata software library is compatible with Mass Memory Systems.

Send for all the facts or call the sales office nearest you. Who knows? Perhaps you'll find our Mass Memory Prodigiously Practical.

## Practically Prodigious

# INTERDATA<sup>®</sup>

OFFICES: EAST COAST — OCEANPORT, NEW JERSEY 201-229-4040 • SOUTHWEST — DALLAS, TEXAS 214-238-9656

UNITED KINGDOM — INTERDATA LTD., WEMBLEY, MIDDLESEX 01-902-3202 • WEST — LOS ANGELES, CALIFORNIA



HOUSTON, TEXAS 713-228-6730 • CENTRAL — CHICAGO, ILLINOIS 312-463-9080 DAYTON, OHIO 513-277-1142

213-670-8386 CUPERTINO, CALIFORNIA 408-257-3418 • NEW ENGLAND — WEST CONCORD, MASS. 617-369-7997



# How to evaluate Sigma 5, 360/44 and SYSTEMS 86 real-time computers.

Take a close look at price-performance.

Not just the words, but a detailed comparison—using actual computer kernels—of the real-time response and throughput rates of each computer operating in a multiplexed I/O mode. With a hard-nosed dollar-to-dollar cost comparison.

It shows one of these machines is not only 15% faster, but more than 15% less in price.

It's the one you helped design. Because it grew out of our experience in meeting your real-time hardware requirements. Satisfying your custom software needs. Solving your front-end application problems.

We'd be happy to share the specific results with you. Just send us the coupons.

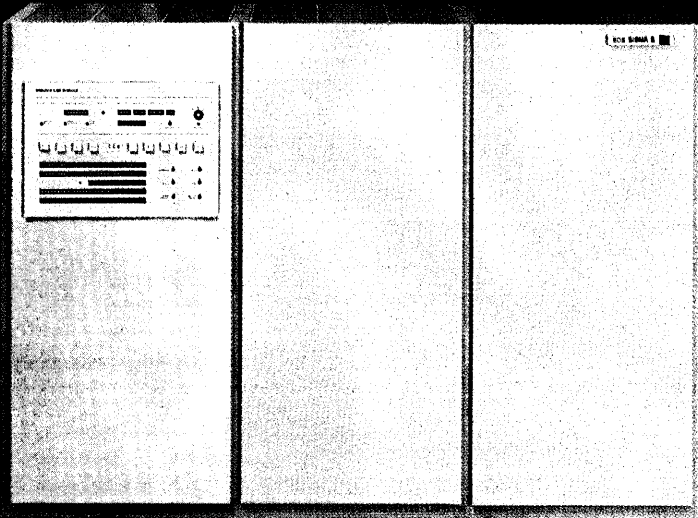

**Sigma 5** 32-bit real-time computer  
 Memory cycle time—850 nanoseconds  
 Typical batch configuration—\$435,000

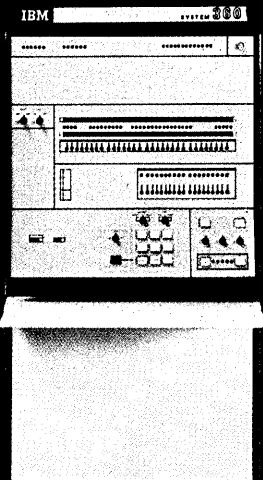

**360/44** 32-bit real-time computer  
 Memory cycle time—1000 nanoseconds  
 Typical batch configuration—\$475,000

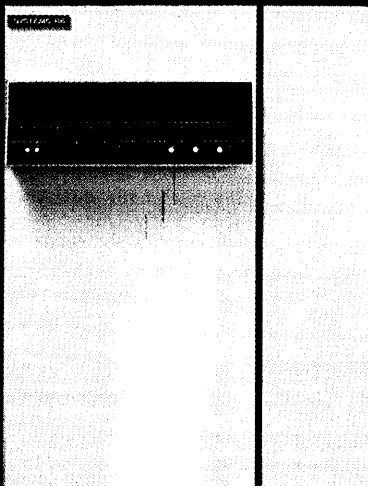

**SYSTEMS 86** 32-bit real-time computer  
 Memory cycle time—600 nanoseconds  
 Typical batch configuration—\$360,000

**SYSTEMS Engineering Laboratories**  
 6901 West Sunrise Boulevard  
 Ft. Lauderdale, Florida 33310

I'd like to see the actual test results that show why the Sigma 5 came in second in your price-performance comparison.

Name \_\_\_\_\_

Company \_\_\_\_\_

Address \_\_\_\_\_

City \_\_\_\_\_ State \_\_\_\_\_ Zip \_\_\_\_\_

**SYSTEMS Engineering Laboratories**  
 6901 West Sunrise Boulevard  
 Ft. Lauderdale, Florida 33310

I'd like to see the actual test results that show why the 360/44 came in third in your price-performance comparison.

Name \_\_\_\_\_

Company \_\_\_\_\_

Address \_\_\_\_\_

City \_\_\_\_\_ State \_\_\_\_\_ Zip \_\_\_\_\_

**SYSTEMS Engineering Laboratories**  
 6901 West Sunrise Boulevard  
 Ft. Lauderdale, Florida 33310

I'd like to know more about SYSTEMS 86. And about how the new SYSTEMS 88 can give me true multi-processing capability in a real-time application.

Name \_\_\_\_\_

Company \_\_\_\_\_

Address \_\_\_\_\_

City \_\_\_\_\_ State \_\_\_\_\_ Zip \_\_\_\_\_

# SATCOM IN REVIEW

by Rowena W. Swanson

Can repeated analysis of a problem help to solve it? Like many other current problems having roots in economic feasibility and human adaptation, the problem of efficient information handling has been defying application of the total systems approach and even of attempts at optimization of subsystems. A study of "the information problem" in science and technology, recently concluded by a prestige Committee of the National Academy of Sciences and the National Academy of Engineering (NAS/NAE),<sup>1</sup> is the occasion for this paper. Did the committee clarify issues about information handling and make them more understandable within and outside the information community? Did the committee offer suggestions that may be able to cut Gordian knots of complexity and confusion that have been choking information storage and retrieval activities?

The committee inherited a sizable legacy of reports of

1. *Scientific and Technical Communication, A Pressing National Problem and Recommendations for Its Solution*, A Report by the Committee on Scientific and Technical Communication of the National Academy of Sciences-National Academy of Engineering. Washington, D.C.: National Academy of Sciences, 1969. Publication No. 1707. (Available from NAS, \$6.95; a *Synopsis* with the same title is available without charge)

2. (a) *Improving the Availability of Scientific and Technical Information in the United States*. A report of the President's Science Advisory Committee. Washington, D.C.: The White House, Dec. 1958.

(b) J. H. Crawford, et al. *Scientific and Technical Communications in the Government*. Task Force Report to the President's Special Assistant for Science and Technology. Washington, D.C.: April 1962. (Available from the Clearinghouse for Federal Scientific and Technical Information (CFSTI), AD-299, 545)

(c) *Science, Government, and Information, The Responsibilities of the Technical Community and the Government in the Transfer of Information*, A Report of the President's Science Advisory Committee. Washington, D.C.: The White House, Jan. 1963. (Available from the Govt. Printing Office (GPO), 25¢)

(d) *Coordination of Information On Current Scientific Research and Development Supported by the United States Government*, Administrative

a guided tour  
through the maze

earlier investigations. Those of broadest scope have emanated from government initiative consonant with the government's position as principal sponsor of producers of scientific and technical information. Significant among these studies have been several commissioned by the White House and undertaken by the Congress.<sup>2</sup>

In 1958, a panel of the President's Science Advisory Committee (PSAC) in the Baker Report recommended that the National Science Foundation (NSF) expand its science information program. This led to Congress including a provision in the National Defense Education Act of 1958 creating an Office of Science Information Service (OSIS) in



Dr. Swanson has been research administrator for the Air Force Office of Scientific Research since 1961 and was previously with the U.S. Patent Office. She has contributed many papers on information systems in such areas as education, libraries, and biomedical applications. She has a BS in chemical engineering from the Catholic Univ. of America, a JD from George Washington Univ. Law School, and has done graduate work in mathematics.

the NSF. In 1961, Senator Humphrey criticized the federal agencies for using Model T information handling methods in a jet age. Thereupon, the President's Science Adviser convened a task force (the Crawford Task Force) that recommended the need for a central authority for policy and supervision of federal information programs. The Federal Council for Science and Technology (FCST), an advisory body to the White House, appointed a Committee on Science Information (COSI) in 1962. COSI was rechartered as the Committee on Scientific and Technical Information (COSATI) in 1964 as a result of the 1963 Weinberg Report (the report of a subsequent PSAC panel). COSATI had delegated work to six panels and three task groups.<sup>3</sup> Two COSATI studies have considered, in detail, aspects of the nation's information handling problems.<sup>4</sup>

These inquiries, however, have focused on information programs of federal agencies. Congressional hearings highlighted the absence of a mechanism for "continuing dialog" among non-federal scientific and technical information activities. In 1965, NSF asked the NAS/NAE to form a Committee on Scientific and Technical Communication (the SATCOM Committee) for the private sector. The SATCOM Committee was established in February, 1966. Its analysis, published in June, 1969, represents the collaborative work of 25 committee members, 7 associate members, 163 consulting correspondents, and 4 task groups.<sup>5</sup>

SATCOM's brief charter directed the committee to examine and make recommendations "on the present status and future requirements of the members of the scientific and engineering community with respect to the structuring, flow, and transfer of scientific and technical information and insight." The committee was to give "special attention" to relationships between activities of the private and federal sectors and include recommendations to both groups. It was also to consider, among other things, methods for promoting effective relationships between systems and users, and needs for greater selectivity and consolidation.

SATCOM was not constrained to any precedent. Its work does warrant comparison, however, with one document in its legacy that similarly addresses itself to both the public and the private sectors.

The elegantly comprehensive Weinberg Report of 1963 contains 11 recommendations. The first five are addressed to the technical community, the last six to government agencies. In brief, its charges to the private sector are:

and Scientific Problems and Opportunities of Central Registration of Research Projects in Science and Engineering. Prepared for the Committee on Government Operations, U.S. Senate, Senate Rept. No. 263, 87th Cong., 1st Sess., May 18, 1961. See p. 276.

(e) *Coordination of Information on Current Federal Research and Development Projects in the Field of Electronics, An Analysis of Agency Systems for Storage and Retrieval of Data on Ongoing Work and of Views of Private Companies on Indexing and Communication Problems.* Prepared for the Committee on Government Operations, U.S. Senate, Committee Print, 87th Cong., 1st Sess., Sept. 20, 1961. Washington, D.C.: GPO, 1961, \$1.00.

(f) *Interagency Coordination of Information, Agency Coordination Study, Part 1, Federal Plans for Improvement in the Design, Management and Use of Scientific, Engineering and Other Information Systems.* Hearings before the Subcommittee on Reorganization and International Organizations of the Committee on Government Operations, U.S. Senate, 87th Cong., 2d Sess., Sept. 21, 1962. Washington, D.C.: GPO, 1963, 80¢.

3. See *Progress in Scientific and Technical Communications, 1968 Annual Report.* Washington, D.C.: Federal Council for Science and Technology, Nov. 1969. Rept. No. COSATI 69-5. (Available from CFSTI, PB-186,400). The purview of COSATI's panels and task groups is: Panel One, Operational Techniques and Systems; Panel Two, Information Sciences Technology; Panel Three, Education and Training; Panel Four, International Information Activities; Panel Five, Management of Information Activities; Panel Six, Information Analysis Centers; Task Group on Dissemination of Information; Task Group on Technology Utilization; and Task Group on National Systems for Scientific and Technical Information.

1. That the technical community recognize the handling of scientific and technical information as an integral part of science.

2. That the technical community explore and exploit such "switching methods" as specialized information centers, central depositories, mechanized information processing, and software development for information handling operations.

3. That individual authors participate in the information transfer process through better documentation of their papers for subsequent retrieval, and that they refrain from unnecessary duplication.

4. That techniques for handling information be widely taught.

5. That uniformity and compatibility be incorporated in the subsystem components of the national information network.

Prefacing its recommendations to federal agencies is the statement that "government information activities must not be allowed to swamp non-government activities." NSF is commended both for encouraging "order in a chaos of non-uniformity" and for supporting information activities without dominating them. Two recommendations to federal agencies that concern other aspects of monitorship advise FCST to continue "surveillance" of government systems and PSAC to continue its "attention" to problems of scientific information, "particularly the balance between government and private activities." Discussing the overlap of federal and private services, the Weinberg Report observes:

"The government agency information systems have evolved without any government-wide policy concerning the relative roles of the private and public enterprises, and some guidance on this tricky issue is needed."

The financial distress of the private sector is attributed more to growing volume and to mission/discipline dualities than to government competition. Nevertheless, how far beyond handling its own reports should a federal service go? Can standards be set as to amounts of information that are needed? How are schemes for handling information to be evaluated? These are some of the questions the Weinberg Report specifically bequeathed to its successors.

The SATCOM Report is a *magnum opus* of 322 pages (ten chapters, three appendices). Chapter 2 is titled "Summary of SATCOM's Thinking and Recommendations." Chapter 3 (110 pages) contains the text of 55 recommendations with

4. (a) *Recommendations for National Document Handling Systems in Science and Technology.* Washington, D.C.: Federal Council for Science and Technology, Nov. 1965. This report is accompanied by a two-volume appendix with the same title, subtitled *A Background Study*, prepared by the System Development Corp., Santa Monica, Calif. The three are available from CFSTI under the single accession number, AD-624,560.

(b) *Study of Scientific and Technical Data Activities in the United States. Vol. I, Plan for Study and Implementation of National Data System Concepts. Vol. II (Parts A & B and Part C are separately bound), Preliminary Census of Scientific and Technical Data Activities.* Final Rept., ARPA Order No. 892, Contract F44620-67-C-0022. Washington, D.C.: Science Communication, Inc., April 1968. (Available from CFSTI, AD-670,606, AD-670-607, AD-670,608, respectively)

5. Of SATCOM's 25 committee members, 10 were from industry, 11 from universities, 4 from non-profit organizations, and none from Government. Nine members of the Committee, including chairman Robert W. Cairns, served full terms. Of the 7 Associate Members, 2 represented NSF, 1 OST, and 2 NAE. Of the 163 consultants, 51 were from industry, 56 from universities, 51 from non-profit organizations, and 5 from Government. Among the consultants, 8 represented commercial publishers (for this count, commercial services are not included), 23 represented professional societies, and 13 represented specifically cited journals or services. By comparison, the Weinberg Panel was composed of 13 members, 5 from industry, 4 from universities, 3 from Government, and 1 from a non-profit organization. Chairman Alvin M. Weinberg is the Director of the Oak Ridge National Laboratory.

# And they lived



# happily ever after.

Our Comcet family of computer communications systems has been living happily together with big multi-terminal computer installations like the IBM 360/40, 360/50 and 360/65 for quite a while now.

Ask Information Network Corporation and Computer Network Corporation—two time-sharing companies who installed Comcet systems to relieve most of their computers' communications overload.

Ask Trans World Airlines—who is installing two Comcet systems to handle the entire communications processing for an IBM 360/50, IBM 360/40, and inter-computer communications with two IBM 360/65's.

Ask the City and County of San Francisco—who are installing a Comcet system to front-end their IBM/360 computer in their communications network used for taxation and finance, law enforcement, public health, hospital administration, social services and personnel administration.

Or ask Optimum Systems, Inc.—their Comcet 60 System will enable their computer center to communicate with the widest possible variety of remote terminal installations giving nationwide service and access to users of the computer utility from anywhere in the United States.

And ask Alcoa Management Information Services who chose Comcet Systems to process international communications traffic for 120 sales offices, manufacturing plants and warehouses.

And ask Computer Response Corporation—who after evaluating many alternatives will install a Comcet communications system for use with their IBM 360/40.

They all chose Comcet because Comcet alone had the most complete, original and economical approach to their

computer's communications problems.

There's little wonder these firms feel like they do. Just by adding a low cost Comcet System, you can almost double your on-line computer's available capacity. Or by combining a Comcet 60 or 40 System with Comcet peripherals, you can have an extremely low cost free-standing computer system for store-and-forward and message-switching applications. And if you want to tie several systems together, there is no solution that even comes close to the Comcet solution, technically or economically.

And then perhaps of greatest importance—Comcet lets you interface your computer with remote terminals of most any manufacturer. Thus you can choose your terminals on a cost/performance basis rather than being forced to choose a particular line of terminals not ideally suited to your needs.

One of the reasons that Comcet Systems can offer solutions to your communications problems that surpass those of the giant computer companies is that we've built a company staffed by the experts of the computer communications field. And, together, we've produced the special new hardware and software needed for designing efficient communications networks.

Ask us to arrange for a technical seminar meeting at your office followed by a demonstration at the Comcet installation nearest you. Write or call Comcet, Inc., Two Research Court, Rockville, Md. 20850. Phone (301) 948-8700.

Or call: Minneapolis-St. Paul (612) 633-8130, Boston (617) 969-3070, Los Angeles (213) 641-3655, N.Y.C. (212) 594-9080, Chicago (312) 298-6180, San Francisco (415) 392-7741, Dallas (214) 357-6557, Houston (713) 524-8119. **COMCET**



elaborating comments. These have been grouped under five headings: (A) Planning, coordination, and leadership at the national level (11 items); (B) Consolidation and reprocessing—services for the user (16 items); (C) The classical services (16 items); (D) Personal informal communication (2 items); and (E) Studies, research, and experiments (10 items). Chapters 4 through 10 give backup documentation; the committee acknowledges outside assistance in this compilation.

Part of the committee's message seems to be addressed to people outside the information-services community. In an effort to educate, and possibly bring understanding to holders of purse strings, SATCOM explains that: "*publication no longer completes the job* of making the results available to the community for whose use they were acquired. The consolidation of information through critical review and evaluation, its condensation for use in announcement, awareness, and access services, and its preparation for storage in computer-managed structures providing for search, retrieval, and selective dissemination—all these are as essential to effective diffusion as is initial publication." This echoes and amplifies the Weinberg Report, which opens with the statement: "Transfer of information is an inseparable part of research and development." Until the importance of information-processing services is recognized by sponsors and customers alike, recommendations and work toward improving the present picture cannot have their most effective impact.

A corollary message concerns who should pay for the information services, an always sensitive matter made more so by the current wave of tightening budgets and mounting service costs. The SATCOM Report takes a shared-responsibility approach expressed in one recommendation as follows:

"Effectiveness and economy demand a basic philosophy of *shared responsibility* between private organizations—those for profit and those not for profit—and the federal government in the management of scientific and technical information."

This carries forward the Weinberg Report tenet:



"There's my application. A few laughs, a few tears, and some heart warming drama."

© DATAMATION ®

"All those concerned with research and development—individual scientists and engineers, industrial and academic research establishments, technical societies, government agencies—must accept responsibility for the transfer of information in the same degree and spirit that they accept responsibility for research and development itself."

SATCOM approves the allocation of funds by federal and private sponsors of research and development for "an appropriate part of the publication process" as an item inseparable from the cost of R&D, and proposes the inclusion of support of some secondary services as well. While SATCOM endorses the use of effective marketing techniques for information services, it cautions that the value and success of some information products cannot be measured by their dollar profitability. SATCOM suggests that a variety of cost and value studies be made to clarify the economics of information handling.

Heading the list of suggestions to the scientific and engineering community is Recommendation A1 that proposes the establishment of a Joint Commission on Scientific and Technical Communication responsible to the Councils of the NAS and the NAE. It should dually serve (1) the scientific and engineering community by fostering coordination and consolidation in the handling of scientific and technical information, and (2) the government by providing authoritative advice on the community's activities and needs. The commission is expected to contribute to planning and policy making and to provide a forum for interaction between the federal and private sectors.

Certain colorful words and phrases seem to emphasize several other suggestions and sentiments of the committee. A point of view is provided in the summary, for example, with the statement that "a chief objective of SATCOM is to build upon and strengthen the present *pluralistic and decentralized* scientific-and-technical-communication complex." The committee finds no critical inefficiency in "this heterogeneous aggregate of activities." It believes that "more comprehensive patterns of coordination and coherence in our information-service structure will be best achieved by voluntary cooperation under appropriate leadership." It does suggest that certain "need groups" (a replacement for "user group"?) deserve more attention. It finds too few adequately designed "third-level information systems" (i.e., customized repackaging), particularly in areas of development and practice. "Reprocessing" and "sifting, evaluating, and consolidating" will provide "the most important thrust" in the near future for overcoming accumulations of information too great for users to cope with. Ways should be found to improve the informal mechanisms used by "communicating communities" (another term for "invisible colleges"?) for transmitting information. Societies should devise publications for "meta information" (i.e., scientific "intelligence," who is doing what and where). Hope is proffered that, in the future, machines can be used (presumably on production scales) for "content-guided processes" in which man and machine "share the intellectual work;" experiments with "evolutionary indexing" by which files can be modified and augmented on-line are specifically recommended.

The significance attached to "third-level" consolidation and reprocessing seems best expressed in a preamble to the category B recommendations:

"A singularly pervasive conclusion in regard to scientific and technical communication is that the functions performed by critical reviews and compilations—digesting, consolidating, simplifying, and repackaging for specific categories of users—are essential if information is to be used effectively."

The committee believes that information products, though necessary for scientists, have particular value for engineers and others who should be using contemporary knowledge in goods and services applications. These activities, of course, depend heavily on the adequacy of the products of "classical services" that should supply most of the raw materials. The "classical services" considered in the SATCOM Report include: (a) abstracting and indexing, (b) selection, acquisition, bibliographic control, reference, and other service functions of libraries, (c) formal and semi-formal publications (monographs, journal articles, patents, technical reports, newsletters, etc.), and (d) informal information exchange (for example, as facilitated by conferences and workshops). The SATCOM Report commends the "third-level" work of information analysis centers, which the Weinberg Report predicted would become accepted retailers of information if they functioned as *technical institutes* rather than as technical libraries.

Most of the category E recommendations lack luster and are, in effect, endorsements either of current research projects on machine applications to information handling and information-service development, or of research program plans that have been dormant in "if funds come" files. One re-exposure that is welcome recommends "critical experiments of operational scale," i.e., with sufficiently large populations and information files to study problems that can't be made real on small scales. Since these experiments must incorporate exploratory development, SATCOM suggests that they be planned and funded differently from research efforts. Recommendation E7 is one of several forcefully worded admonitions to professional societies, in this instance to more aggressively keep members informed about new information technologies and to involve members in information experiments.

### a partial legacy

SATCOM's charter embodies the scope of NSF's jurisdiction, namely, the non-federal sphere and the relationship between federal and non-federal activities. It follows the Weinberg prescription that the balance between federal and private activities be continually reviewed. The charter does not specifically, or by implication, embroil SATCOM in matters concerning "standards" and "evaluation" that the Weinberg Report bequeathed to future groups. By requesting an examination "in broad perspective," the charter does not impose the burden of making comparisons and value judgments, nor did SATCOM assume this burden.

Over-all, the SATCOM Report warrants commendation for the depth of its investigation and the specificity in its recommendations. Its survey chapters (4 through 9) satisfy the charter's "present status" mandate. It could be contended that this material duplicates other reports. This is true, but SATCOM's summaries, in the aggregate, are unique. Their preparation was necessary for SATCOM's deliberations; making them generally available is a service to students, the information community, and the general public. It could also be contended that SATCOM's recommendations, other than those concerning the Joint Commission in the NAS/NAE, add nothing essentially new to the items of the Weinberg Report. This is also largely true, but SATCOM's recommendations should not be faulted for this reason. In the years since the Weinberg Report, experience has been acquired with various instruments for processing and disseminating information, and an awareness of information services has crept into the consciousness of some scientists and engineers. It was incumbent on SATCOM to update the

record. Moreover, the recommendations accurately reflect the heterogeneity that has occurred in the intervening period. Perhaps SATCOM is to be credited for its verbosity, repetition, and inelegance since these bare many of the gaps and ills rampant in today's handling of scientific and technical information.

Regrettably, SATCOM's recommendations concerning "future requirements" are based mainly on supposition rather than knowledge of the information people need for their work in science, engineering, and development. SATCOM chose to dispense with some hundreds of user studies as having been conducted by so many different methods in so many different fields as to have limited generality and usefulness. Does this reflect the purist snobbishness of statisticians who decry the messiness that arises in trying to fit the behavior of people into numeric boxes? Or is this an overtone of the difficulty SATCOM faced in attempting to digest a vast amount of information in real time and its willingness to apply its "broad perspective" charter to an area in which experience is only slowly being acquired? SATCOM's recommendations concentrate on the third-level services it assumes "need groups" will require. The category B recommendations contain sound suggestions for the production and funding of these services. However, SATCOM apparently believes that the existence of new packages and more support for library services, with some education in the use of these, will stimulate "readjustment of the habits of the scientific community." Though SATCOM knew the critical value of person-to-person communication for information transfer in at least some environments,<sup>6</sup> it chose to refrain from recommendations on how to exploit this phenomenon (though it does advocate bringing people together via meetings, fellowship programs, etc.).

Of SATCOM's 55 recommendations, 23 mention money, a few in connection with cost studies but most with respect to who should fund various activities. The principal burden is placed on the federal sector. Might one infer, from the detail to which some cost factors are explored, a possible preoccupation of some of SATCOM's non-federal members and consultants with financial matters? Federal support of scientific and technical information activities in 1968 was about \$357 million, 37% of which was spent on contracts and grants with the private sector.<sup>7</sup> Another \$368 million was spent, 95% by federal agencies, to acquire and process general-purpose scientific data.<sup>8</sup> The federal sector's \$16.2 billion expenditure for R&D is about three-fifths of the nation's investment in R&D. The common argument for federal commitment to information activities is that they are an inseparable part of R&D. This same reasoning, then, should apply to other R&D sponsors. No tabulations show what the private sector has invested in information activities, nor does SATCOM suggest a particular division of future responsibilities. Moreover, in calling today's "apparent disorder . . . the early stage of a major step in hand-tailoring

6. See, for example, ref. 1, pages 45, 97, 104. A summary of some of the approaches that are being explored to capitalize on people as information-transfer agents is given in Rowena W. Swanson, *Information Entrepreneurship and Education . . . Prescriptions for Technical Change*. Arlington, Va.: Air Force Office of Scientific Research, March 1969. (Available from CFSTI, AD-686,093)

7. *Federal Funds for Research, Development, and Other Scientific Activities, Fiscal Years 1967, 1968, and 1969*. Vol. XVII, Surveys of Science Resources Series. Washington, D.C.: National Science Foundation, 1968. NSF 68-27. (Available from GPO, \$2.00)

8. *Ibid.* The Bureau of the Census and the Navy Dept. have the largest programs. Over 70% of the total was for data in the natural sciences, the remainder in the social sciences. Expenses for the collection and processing of these data are excluded from the \$357 million for scientific and technical information activities.

information access," SATCOM predicts that need-group services will *grow* in number and diversity! Where is the upper bound? Perhaps the real guide both to sponsors of services and the scientific and engineering community is a SATCOM observation: "Economics and the increasing overlap of various disciplines eventually must force greater cooperation, with a consequent decrease in duplication of intellectual effort."

Neither SATCOM nor predecessor advisers have suggested imposing an autocratic czar over information activities, even in the federal sector. Such control could produce little but chaos in the present environment. Excessive pluralism probably exists, principally in systems having large data bases. Whether these are mission or discipline oriented, most of them are long established, have a large dependent clientele, and represent considerable money and manpower investments. Some large systems, such as those of the Chemical Abstracts Service in the private sector and the Defense Documentation Center in the federal sector, developed independently to meet needs that were not being satisfied when they were established. Recently, services have appeared principally in the private sector, such as the *Pandex Current Index to Scientific and Technical Literature*, that knowingly overlap the spheres of existing private and federal systems. These are also intended to meet needs their creators believe are not being satisfied with respect to coverage, timeliness, or comprehensiveness. Since knowledge is very incomplete on how information should be organized, how systems can optimally be structured, and what users' needs really are, alterations of existing systems could be based on little but arbitrariness.

It is precisely this ad hoc nature of growth of information systems and services that SATCOM and other study groups have advised be replaced by a mechanism that can guide an orderly assessment of the present situation. An assessment alone should be sufficient to disclose weaknesses and strengths of existing approaches that should, if publicized, have a regulatory impact far healthier for system evolution than dictatorial decrees.

The SATCOM recommendation of a Joint Commission in the NAS/NAE for policy planning and guidance should be received favorably since it is in the mainstream of on-going grass roots activities. In the federal sector, for example, COSATI has had considerable influence in bringing agencies responsible for various mission-oriented systems together to consider areas of cooperation. The major national libraries, the Library of Congress, the National Agricultural Library, and the National Library of Medicine, have been conferring. The Clearinghouse for Federal Scientific and Technical Information is becoming a single source for the acquisition of documents produced under Department of Defense, Atomic Energy Commission, National Aeronautics and Space Administration, National Science Foundation, and federal translation program auspices. The data compilation programs of 28 centers located in both federal and private institutions are being coordinated by the Office of Standard Reference Data of the National Bureau of Standards. In the private sector, the American Institute of Physics, representing 7 member societies and 19 affiliates, has been researching the requirements for a national information system in physics and has developed new products for disseminating information. Eighteen profit and nonprofit organizations offering abstracting services have provided a discussion forum for themselves under the banner of the National Federation of Science Abstracting and Indexing Services. The Tripartite Committee, representing the United Engineering Trustees, *Engineering Index*, and the Engineers

Joint Council, has commissioned several studies to discover how to best meet engineers' information requirements. The NAS/NAE Commission could give added impetus to this work and could also serve as a spokesman for it in user communities and at high-echelon planning conferences.

Irrespective of a central commission, economics, as SATCOM observed, will increasingly pressure existing groups to collaboration and coordination. This trend should be alerting individuals at operating levels—system designers, language designers, programmers, classification experts, information transfer specialists—to the inevitability of requirements for new and innovative ideas. Large-scale processing possible with computers suggests a direction toward bigger but more economic systems capable of serving larger groups of users but in a more individualized way.

Many breakthroughs have yet to be made in perfecting the information quality and specificity of data bases, in automatic adaptive association of stored items, in file organization, in user-oriented languages, in on-line hardware configurations rapidly responsive to large numbers of users simultaneously, etc. Present money and manpower shortages have delayed or impaired research already proposed toward some of these objectives. Inventiveness can, in some instances, overcome even these drawbacks. The climate should also suggest to academic institutions that vitalization of their sluggish development of information science programs is past due. That today's senior ranks of information personnel are largely self-trained is the phenomenon of an emerging discipline, but persistence of the need to educate on the job is becoming a disgrace. SATCOM's recommendation for collaboration and cooperation might well be extended to curriculum development that is also an opportunity area of considerable challenge and scope.

#### postscript

The SATCOM Report shows some surprising omissions. As summaries and tutorials, its backup chapters are good, but there is no subject index! Cross references appear in the text, but they are sparse and incomplete. Presumably SATCOM possessed the documents of the many Congressional inquiries reviewed in chapter 8 that will not be easy for the uninitiated to identify. The report provides references to only two of these.<sup>9</sup> There is essentially no documentation of the chapter 9 review of cooperative international activities. Though SATCOM was aware of NASA's Technology Utilization program and the Department of Commerce's State Technical Service program, its lack of references to studies produced by these programs may explain its minor attention to information specialists in entrepreneurial transfer roles.

In support of its advocacy of pluralism, SATCOM biases its assessment of the centralized U.S.S.R. information system by comparing it with our best.<sup>10</sup> Again, there are no references, nor do several individuals familiar with the U.S.S.R. network appear among the consulting correspondents. Nor is any Office of Education representative listed, though OE programs are the subject of a recommendation.

On the brighter side, section E of chapter 4, on serials, is so well and informatively written that it warrants special mention. ■

9. See ref. 2. A recent update is *National Science Research Data Processing and Information Retrieval System*, Hearings on H.R. 8809, A Bill to Amend Title IX of the National Defense Education Act of 1958 to Provide for Establishment of a National Science Research Data Processing and Information Retrieval System, before the General Subcommittee on Education of the Committee on Education and Labor, House of Representatives, 91st Cong., 1st Sess., April 29-30, 1969. Washington, D.C.: GPO, 1969. 10. Ref. 1, p. 21.

# New Data Modem

**AUTOMATIC EQUALIZATION.** The ADS-448 modulator-demodulator automatically equalizes your data source to the telephone line. No manual adjustments.

**4800 BITS PER SECOND.** This super-modern modem can transmit and receive data in any combination of data rates 1200, 2400, 3600, totaling 4800 bits per second. It is useful in a variety of data systems.

**LOW ERROR RATE.** Typical error rate is less than one in five million bits. Self-checking loop-back is built in. The modem is insensitive to telephone line phase-jitter.

**FRONT PANEL DISPLAY.** System diagnostics — including relative line condition — are displayed continuously on color-coded lights on the front panel.

**MODULAR DESIGN.** One of a family of compatible, solid-state data system modules by American Data Systems, the ADS-448 is versatile, reliable — practical in every respect. Send for full details.

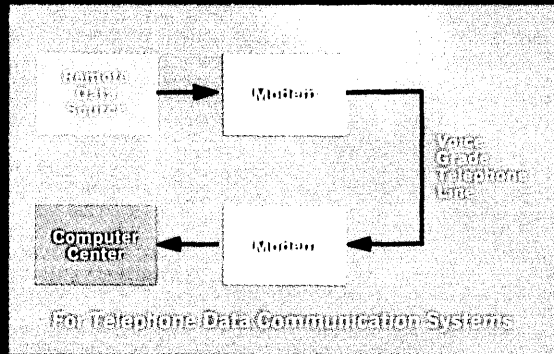

# Ads

Telephone (213) 882-0020  
 AMERICAN DATA SYSTEMS  
 20747 Dearborn St. • Chatsworth, Calif. 91311

DATA MODEMS □ DATA MULTIPLEXERS □ DATA TERMINAL □ DATA SYSTEMS



# A RATIONAL NUMBER CALCULATOR

by S. Berkowitz



When a manufacturer's representative visits the Applied Mathematics Laboratory at the Naval Ship Research and Development Center in a persistent effort to sell an electronic calculator, he is generally confronted by our resident numerical-analyst-of-repute.

The following protocol is typical of such a confrontation. Analyst: Kindly tell me how many places of accuracy I can get out of that machine.

Representative: Depending on the problem, sir, you can get a maximum of 10 digits after the decimal point. For example . . . (proceeds to calculate the solution to a few simple problems). Notice how the response time . . .

Analyst: Just a moment, please. I see 20 places on the machine. Why is there only 10-place accuracy? I have not seen you fill up all 20 places. How about doing that?

Representative: Well, I only use simple numbers for demonstration purposes.

Analyst: How about dividing 213 by 57?

Representative: All right, here it is.

Analyst: What happened to the remainder?

Representative: What do you mean by the remainder? There it is in front of you. Oh, I see. You mean, is it truncated or rounded? It is rounded up.

Analyst: You are confusing the remainder with the quotient. Moreover, the quotient that I see in front of me has been truncated in the tenth place. I would still like to know what you did with the remainder.

Representative (By now a bit flustered): I did nothing with the remainder. The machine, like all others, has a certain bound on its accuracy. After all, what do you do with the remainder?

Analyst: I keep it in my head. They don't build machines the way they used to.

Shattered by the experience, the salesman packs his demonstration kit and quietly returns home. The laboratory does buy calculators, but each representative is left with the impression that his device is but the least of many evils.

In the remainder of this paper, we discuss the system design of a device that might satisfy the analyst's requirements. No mention will be made of the frills—the display, the reserve storage, the programmability, the special function calculator; not even the floating-point exponent or the hardware implementation! All the hardware exists on the open market and construction is well within the state of the art. One needs only an applications engineer to put the machine together. What interests us is the question, "What happened to the remainder?"

Addition and subtraction are no problem on a calculator: one gets out as many digits accuracy as one puts in. For multiplication, however, the product will contain, at most, a

number of digits equal to the sum of the number of digits in the multiplier and multiplicand. A simple-minded way to solve the problem, then, is to display the complete product in two registers, each with as many digits accuracy as the largest possible multiplier or multiplicand. As we will see, there is a one-display-register solution too. The biggest hangup seems to come with division, for if one asks a hardware engineer to supply all the digits of a quotient, he might reply, "But there might be an infinite number of them!" It is true, in a sense, that there might be an infinitely long quotient, but what is relevant is that the ratio of two rational numbers has a cyclic expansion; consequently, such a quotient is completely describable by a finite set of digits. For example, dividing 6.14 by 11 gives .55818181. . . . The quotient can be described as a leading sequence .55 and a 2-cycle 81. Indeed, one can see that the number of digits in the cycle must be less than the (value of the) divisor since: (1) at any step of the division, the remainder must be less than the divisor; (2) therefore, the number of different possible remainders is less than the (value of the) divisor; (3) after the leading sequence, a cycle is established once a remainder is repeated, since the remaining dividend digits are zeroes at both occurrences of the remainder.

Space limitations preclude building a device that would display the leading sequence and cycle. However, one can secure the remaining digits of a division for the user simply by supplying him with the remainder. The user may then record or use the remainder to find the remaining digits. A more sophisticated convenience would be to add an additional internal register which would contain the remainder at the head of a sequence of zeroes. At the user's command, the register contents would be entered into the dividend register, divided by the divisor, and displayed as a quotient. The command could be repeated until the user had as many digits as he required. Moreover, for multiplication, the additional register, whose size would presumably be equal to the size of the display register, could store the remaining digits of the product and transfer them to the display register on command.

The technology is at hand to afford the user the convenience of retrieving the remainder. The only open question is whether the marketing people feel that there is a sufficient demand to economically justify production of such an option. Certainly, it would make the astronomers and numerical analysts happy, but is anyone else out there interested? Someone mentioned recently that there was an old hand-cranked machine that produced quotients, digit by digit, *ad infinitum*.

"They don't build machines the way they used to" (sigh). ■

# WHY WE'VE TRAINED MEN FOR A VANISHING BUSINESS.

The unit record business is disappearing so fast it takes a service force of almost 1,000 men to keep our customers happy. There are over 6,000 customer installations, many of which run their punched card equipment day and night.

Here we are in this so-called defunct business and still we're working nights and weekends keeping up with the workload. The only thing that's vanished is the eight-hour day.

That's not all that surprising considering there are about 40,000 unit record installations in this country, with an estimated 600,000 pieces of punched card machines now in use.

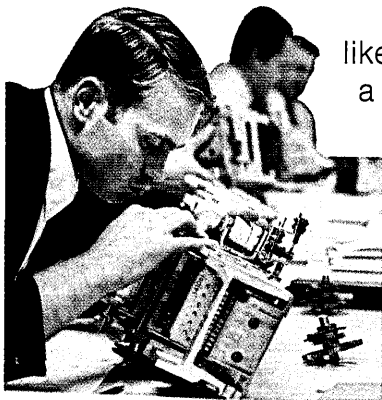

With numbers like those you need a lot of well trained professionals in a lot of places. Which is why we can provide 24-hour service in more than 50 locations.

It would be nice to be in a business that wasn't always vanishing. But you get used to it. They first closed the book on the unit record business 15 years ago when IBM brought out the 650. Then came the 705. Now it's the System/3 and we are once again the Ghost of Data Processing Past.

Yet everywhere you look you see those familiar old tabs and sorters and calculators,

humming away, getting the work out. Unglamorous, uncomplicated, and inexpensive. So inexpensive, that it's possible, for the price of one hour's computer time, to rent a small unit record combination for a whole month.

A lot of people know this, and a lot of people take advantage of it to get more out of their computers, and at great savings. Bog a computer down with a lot of raw data and you're likely to bog down your profit and loss statement as well.

Then there are things like computer editing and back-up. Not exactly the stuff of tomorrow's headlines, but not to be ignored either. Especially when the auditors are hanging around.

In the salons of technology they twitter about the new computers, and sometimes we do, too. But all those workaday calculating tasks keep piling up, problems in search of an economical solution. That's why all those punched card machines are still around. Along with all those well trained men to care for them. You need good men in a vanishing business.

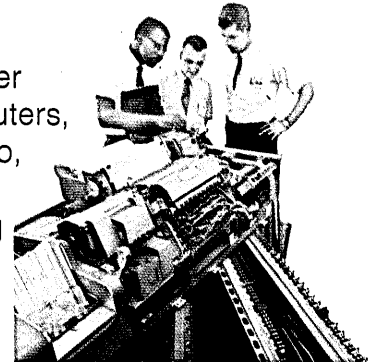

- Please send me your new unit record brochure.  
 I would like to discuss my data processing needs.

Name \_\_\_\_\_

Company \_\_\_\_\_

Address \_\_\_\_\_

City \_\_\_\_\_ State \_\_\_\_\_ Zip \_\_\_\_\_

**MAI** Equipment Corporation

300 East 44th Street, New York, New York 10017



# TRENDS IN MIS TECHNOLOGY

a forecast

by Frederic G. Withington

At Arthur D. Little, Inc., we are required to perform a considerable amount of product design and technological forecasting in computer-related fields, so we hope we are reasonably conversant with all the technological trends which are likely to affect MIS technology during the next five years or so. For this paper I have surveyed each of our hardware and software groups working in relevant areas and have obtained from each a projection of what they think technology will make possible between now and 1975. First, I will present to you a brief capsule of the forecast in each separate area of technology; then (bearing the demands of the MIS market in mind), I will present what we believe is the most likely synthesis of these possible technological developments into the kind of MIS-oriented computer system likely to be available by 1975.

First, let us consider the cost-performance of electronic logic circuits, since this underlies the capability of any computer system. Fig. 1 summarizes both the history and the long-range forecast of our engineers in this area, showing curves relating the pulse rise time in nanoseconds for typical circuits to the year of availability. Germanium and silicon transistors are shown, both separately and in circuits, and compared with "ideal" transistors. It is apparent that the performance of the real devices (taken separately and not in circuits) has already approached that of the ideal transistor, and that it is still improving. Comparable curves are shown for MOS (metal oxide semiconductor) integrated circuits and for both economical and high speed versions of conventional integrated circuits. Evidently discrete components will continue indefinitely to offer higher performance than integrated components. It follows that the highest performance computers may continue to use dis-

crete components as they do now. Also, the curves for all the devices are approximately parallel; therefore, between now and 1975 about a fivefold increase in circuit speed can be expected, regardless of which type of device is considered.

Circuit speed is of little meaning without consideration of cost, so Fig. 2 shows a corresponding relationship of cost to time for the types of integrated circuits most likely to be used in MIS-oriented computers. It is clear that a dramatic improvement is likely in low cost MOS circuits between now and 1975; they could drop to 10% of their present cost. Higher performance integrated circuits are also likely to decrease in cost as manufacturing technology improves and as the number of effective circuits per chip increases, but



Mr. Withington has been with Arthur D. Little, Inc., for ten years as a consultant to users and manufacturers of computers. Before that he held various positions with the Burroughs Corp., ElectroData Corp., and the National Security Agency. He is the author of "The Real Computer: Its Influence, Uses and Effects" and "The Use of Computers in Business Organizations."

(This paper was presented at the first annual conference of the Society for Management Information Systems, Minneapolis, September, 1969.)

the higher speed devices are unlikely to decrease in cost more than about 50%.

It appears, then, that a tenfold or twentyfold improvement in the combined cost-performance of circuits can be expected within the next five years. The result will be that designers will feel free to "hard-wire" a wide variety of functions for MIS-oriented machines, since the cost of adding functions will be so low.

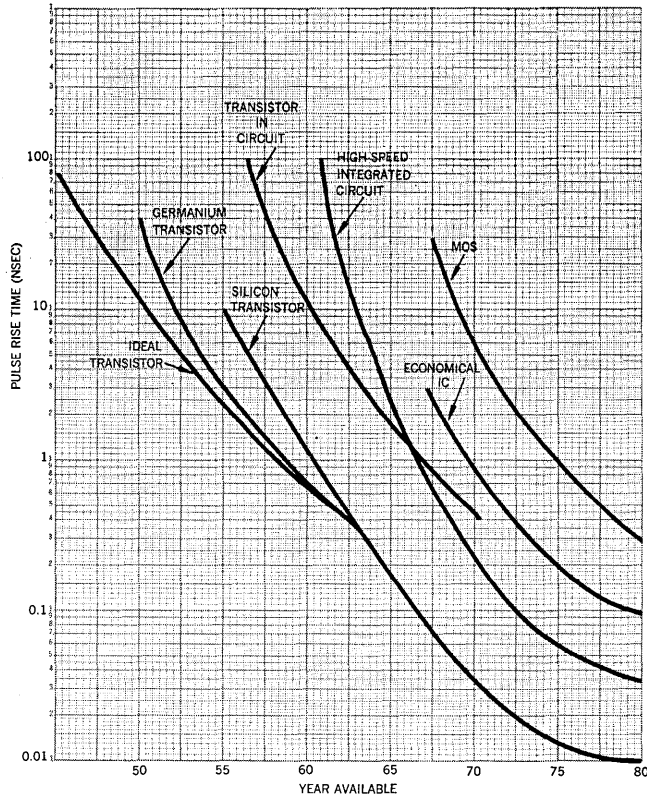

Fig. 1. Circuit pulse rise times.

The faster computers are already constrained more by memory performance than by circuit performance, so let us consider next the improvements in memories that can be expected. Fig. 3 summarizes what our memory experts forecast in this area. Cycle time is shown against year of availability and, for each class of memory, a family of curves appears for several levels of cost per bit. Core memories have considerable further improvement potential, but theoretical performance limitations will probably be approached by 1975. Thin-film memories, just now appearing on a large scale in Burroughs' equipment, can potentially perform better than the best cores. However, it will be several years before they can match core memory prices. It is semiconductor memories (large scale arrays of integrated circuits) that offer the really exciting potential. Our engineers are willing to predict that they will overtake all other types on a price basis as well as on a performance basis within three or four years, but this is admittedly conjectural.

There are many problems involved in integrating new memories into existing computer lines, so in 1975 and even beyond we will probably see the manufacturers intermixing different kinds of memories in their computers. This is not critical to the user; the important thing is that he continues to gain cost-performance in the memory area as well as in the circuit area. Apparently, by 1975 an improvement of memory cost-performance of tenfold is likely to be attained, regardless of which of the three classes of memories is involved. Also, apparently computer memories will con-

tinue to improve until (at last) they are no longer a constraint on what the user wishes to do. In time, perhaps even mass storage of files will be done using solid-state rather than mechanical technology. However, the necessary very low cost solid-state memories are not likely to be available for perhaps as long as 10 years. The same considerations apply to radical technologies such as the "magnetic bubble" circuits recently announced by Bell Telephone Laboratories. There is great inertia in this industry now, and many have learned to their sorrow that many years intervene between laboratory demonstration of a device and large scale employment of it.

As always in the past, the availability of higher performance electronic components will lead to innovations in the systems employing them. I will say more about this later, when I present our view of the MIS-oriented computer system of 1975. For the moment I would simply like to note

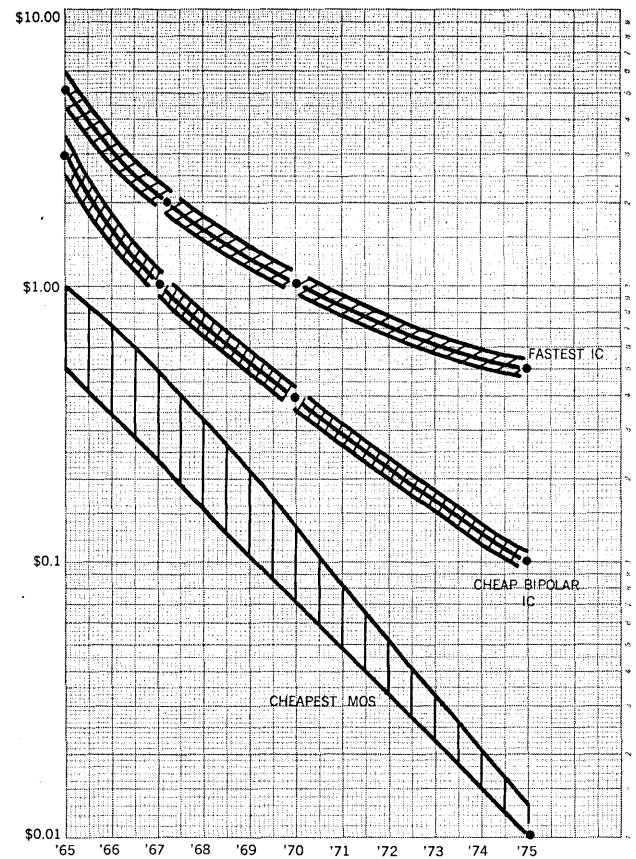

Fig. 2. Logic circuit cost per bit vs. time.

three developmental trends in large-scale processor organization which are likely to have reached maturity and therefore be available for possible use in MIS systems by 1975. First, we observe a trend toward asynchronous, independently operating, peripheral controllers in the more modern, powerful systems. This is confused because some of the manufacturers still maintain that it is preferable to retain i/o channel and peripheral device control within the central processor complex. However, we observe that increasing numbers of manufacturers, striving for higher over-all system efficiency, decouple the individual components of the system so that they may perform parallel operations asynchronously. We believe that this is a general trend, and that all will move toward independently operating peripheral controllers.

A second major trend in system architecture is occurring

among the very large scientific computers now in development. The Illiac IV at the University of Illinois is an array processor involving a theoretically unlimited number of independent processing modules connected in matrix fashion so that the processing of a job can be distributed among them and some form of ultimate parallelism may be approached. The STAR computer of Control Data Corp. employs pipeline design, in which a single computer instruction can initiate the processing of an entire stream of data, thus obtaining higher speeds because the number of instruction accesses and interpretations drops. It is not clear to us that either of these types of system architecture, designed as they are primarily for manipulation of large matrices and models, will be applicable to the kind of problems encountered in management information systems. The designers of the computers assert that they will be; the next few years will make this clear.

system architecture by 1975 than there ever has been. However, it seems that we can somewhat tentatively forecast that all large on-line systems will at least incorporate redundant, semiautonomous processing elements.

Since some of the main cost-performance constraints on the design of MIS systems are found in the peripheral device area, it is equally important to consider development trends in peripheral devices.

Unquestionably the most important peripheral device for MIS is the file storage device. Many users find that today's mass storage devices simply do not have the capacity, at reasonable cost, to hold the necessary files. There is considerable talk about novel methods of performing mass storage (such as holographic, or electron beam recording, or a variety of optical or cryogenic devices), but as far as we can see none of these is advancing very fast. During the next five years we envision magnetic-recording technology remaining predominant, probably still using rotating-disc mechanisms. Nevertheless, we think large improvements are in prospect, because packing densities can improve sharply. By 1975, we think, somewhere between 5 and 10 times as many bits are likely to be stored per unit area of disc surface. This alone is a dramatic improvement, even though the devices do not mechanically change very much. The result would be devices offering as many as one billion bytes of storage capacity, with 50 msec random access, and a purchase price of some \$300,000. In our experience such devices would solve most file storage requirements, without waiting for the more exotic new forms of mass storage technology.

The I/O devices of importance to MIS take many forms. Conventional high speed peripherals are needed, as well as a proliferation of different kinds of terminals, optical character recognition (OCR) devices, and the like. There is a great deal to be said about these, but I intend to skip the subject almost entirely because in our view every area of I/O device technology is closely constrained by electromechanical problems and human interface needs. As a result, we do not expect any revolutionary improvements; rather, continued evolution within the present forms and at prices comparable to today's except for some types of terminals that could drop greatly in price. This is not to say that important changes will not occur. We think there will be much wider use of OCR, of audio output and (to a limited degree) input, of microfilm interfaces, and of graphic terminals. The result will be a considerable improvement in the cost-effectiveness of MIS, even without radical change.

The last and most important of the technological areas I would like to discuss is software. It is truism that today's MIS systems are more constrained by software capability than by hardware. Given anything like the technological improvement in hardware I have forecast, software problems will become almost completely predominant. Unfortunately software progress is much more difficult to forecast than hardware progress, but our work has developed a few conclusions I would like to offer.

First, and perhaps most surprising, we believe that no important new software functions are likely to be developed between now and 1975 and that none are needed. A long and careful study we recently completed indicates that today's operating systems, terminal and data management systems, and language processors would be completely adequate to meet users' needs if only they were reliable, efficient, and convenient to use. Of course, some "bells and whistles" will be added, some new language functions, some more options in file organization, indexing and message formatting; but none of these is critical. The software

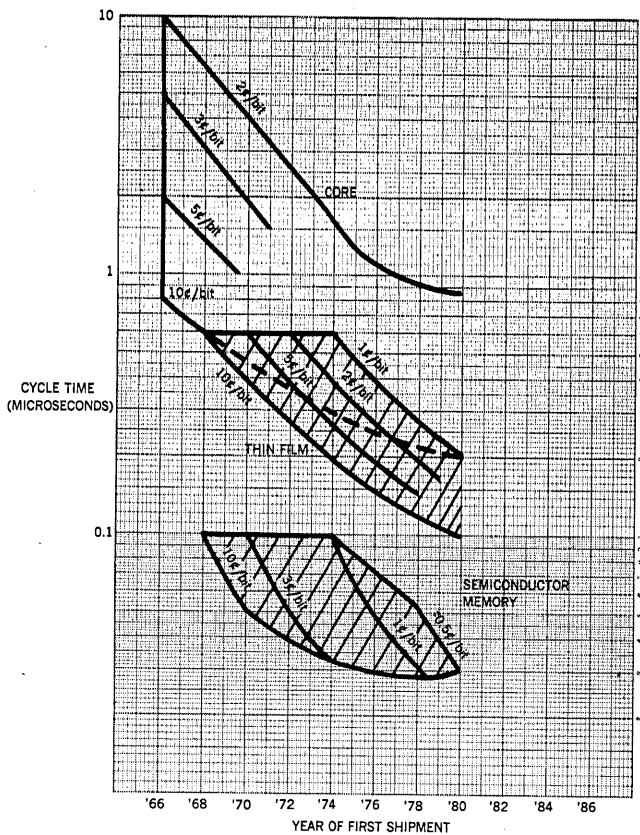
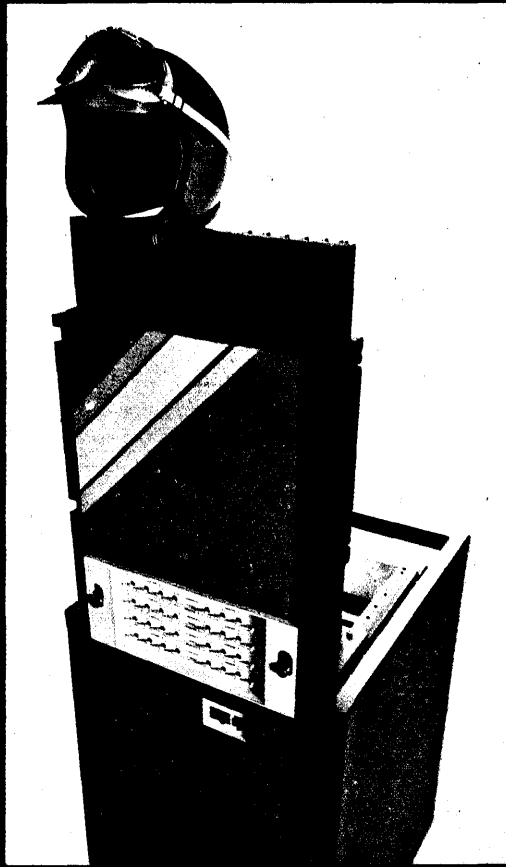

Fig. 3 Memory Cost and Performance

The third architectural trend I would like to note is a universal one toward multiprocessing in MIS-oriented systems. It has become clear to virtually all users and manufacturers that when they wish to perform varied processing simultaneously it is always advantageous to divide the work among two or more processors, either identical or somewhat specialized, as dictated by the problem. IBM has held out against this but the popularity of their ASP configurations is undeniable. Burroughs, GE, CDC, and Univac are all advocating multiprocessor systems. Even the more recent pure time-shared configurations, such as the Honeywell 1648, tend to use more than one processor; one for management and the other for computation.

The precise outcome of all of these trends in system architecture is not entirely clear, and in fact there is no more likelihood that there will be complete uniformity in



## The DSU-8100 "Fastrack".™ A real winner in the mass memory race!

You don't win the Grand Prix or the "500" by driving a truck — or weaving all around the track. The same is true in the mass memory race.

Until now mass disc memories were ponderous brutes. They took up a dozen feet of valuable floor space. Weighed close to a ton. Required thousands of kilo-watts. Most used positioning heads which do have drawbacks. Time lost in positioning. Positioning errors. Positioner wear. Maintenance.

CPC has changed all this with a fast head-per-track disc memory which stores up to 200 million bits in a compact 19" chassis just 40" high. It weighs only 300 pounds. Requires but 1 Kw of power.

The secret to on-site expansion is the modularity. From one through four 25 million and/or 50 million bit disc modules may be used on the same compact drive. 256 "fail-safe" flying heads per surface access data fast. 16.7 milliseconds average. Data transfer rate is 3 MHz.

There's more to tell. Like the single disc security which eliminates the possibility of head avalanche. Or a worst-case-failure recovery time of only minutes. Or the ability to serve up to 3 controllers.

Want the whole exciting story? Request a copy of our DSU-8100 brochure.

**CPC** computer peripherals corp.  
5037 Ruffner St., San Diego, Calif. 92111  
Telephone (714) 279-7500

CIRCLE 122 ON READER CARD

**DSU-8100 Fastrack™**

A new concept in rotating memories...  
Designed for the exploding world of  
Program Swapping, Time Sharing,  
Message Switching and Real Time Computing.



It Had To Happen

# System 360

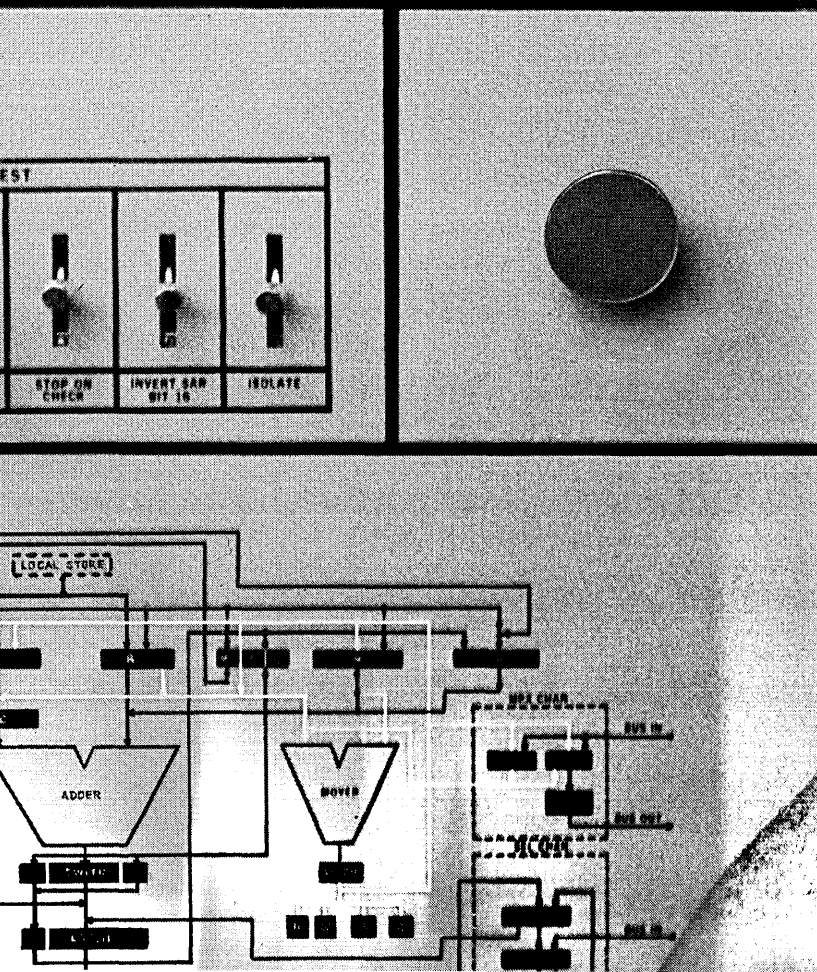

# YOUR 360 NEEDS A FRIEND

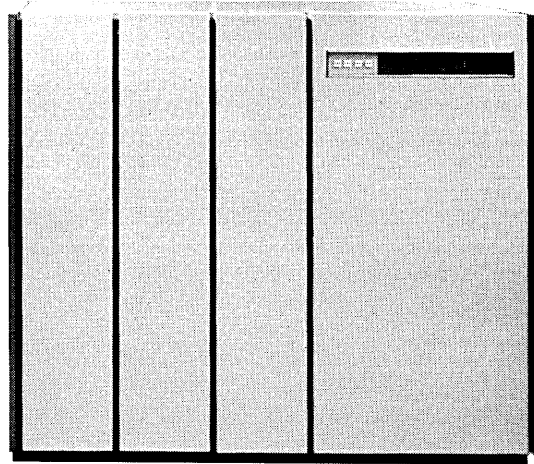

## THE NEW ASTRODATA ELECTRONIC DATA SORTER

Your System 360 is probably operating at low efficiency because it's spending up to 60% of its time sorting data. No more! Astrodata's new 1561 Data Sorter will store, sort, and return sorted records to the computer at high rates, giving the 360 CPU that much more time for real computing.

**Plus:** The 1561 frees core formerly assigned to sorting functions, permitting more work, greater throughput.

**Plus:** The 1561 produces string lengths 20 to 200 times longer than present methods, meaning fewer merge passes, less CPU time and less I/O time for each sort.

**Plus:** The advantage of the 1561 increases with key length for it sorts over long keys as quickly as short.

**Plus:** The 1561 holds 65,536 records at a time, a total string length of 2.6 million bytes. That's real capacity.

**Plus:** It's plug-to-plug compatible with all 360s running under OS, and is delivered with "bundled" software that fits directly into OS Sort.

**And:** Wonder of wonders, the 1561 actually documents its own justification. Part of the software is the Astrodata Sort Usage Monitor — ASUM — that records the amount of sort time utilized, the increased efficiency of the 360, and the relative savings in \$.

### NEW BROCHURE

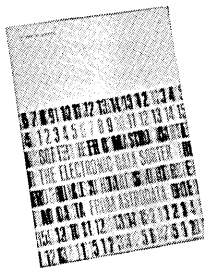

There's a new brochure available on the 1561 Data Sorter—a copy will be forwarded on request. If you need immediate information, please call (714) 772-1000 and ask for Sorter Sales.



ASTRODATA INC., 240 E. Palais Rd., Anaheim, Calif. 92803; (714) 772-1000

CIRCLE 129 ON READER CARD



designers have adequately and completely specified all the major functions needed for MIS. The problem is now to make them work.

One reason for unreliability of software, and for inconvenience in its use, is variety. The more different options and processing methods available, the more possibilities there are for bugs and the more the user is required to think of when he attempts to use the software. In attempting to improve reliability and convenience of use, we think software designers are increasingly going to adopt generalized, brute-force processing methods which apply a minimum number of data organization and processing options to the full range of problems. This can be done without theoretical difficulty, but at a very high cost in efficiency; it has therefore been an intolerable approach so far. However, given the forecast degree of improvement in cost-performance of computer electronics and memories, a higher degree of inefficiency is likely to be tolerable.

This is not to say that efforts will not be made to improve efficiency at the same time. Even with the penalty of increased brute-force processing, the great speed gains of the circuits and memories may produce a net improvement. Furthermore, various forms of firmware are likely to become available to enhance software efficiency. Stored logic is likely to be used for "kernels" of frequently used system software functions. Associative techniques are likely to be applied with increasing frequency to memory paging, and perhaps also to interrupt and task management functions. Pushdown stacks may be applied to job queues as well as to language processing. It is impossible to forecast the nature or variety of these devices for enhancing software efficiency; this is one of the most exciting areas in the entire field of current computer system development. The result is that large quantities of electronic hardware will be added to the system that do little or nothing to increase the actual throughput capability of the computer. We begin to envision the MIS-oriented computer system of 1975 as not necessarily much faster in terms of throughput than the system of today, even though it incorporates far larger quantities of electronics having much higher speed. Instead, it will have traded off processing speed for simplicity, reliability, and generality of software through the use of brute-force processing methods and hardware-assisted software.

### internal monitoring

One of the problems with all real-time systems is that it is very difficult to determine what is actually happening inside them. Users wish to study existing bottlenecks in systems in order to improve their performance and to identify failures before they cause irreparable harm or delay. Therefore, they need software tools to report on system status and operability. In a sense, users wish their systems to become "self-conscious." There is nothing inherently difficult about the software to do this. Failure diagnosis programs are now used in virtually all computers, particularly in real-time military systems. Also, status and workload monitors are already in partial use. (Remember the computer in the lunar module of Apollo 11 complaining about being overloaded?) We believe that by 1975 system status and monitoring software for all kinds of fast-response computer systems will be a matter of routine.

Finally, at a more mundane level but of even more importance, we believe that the MIS computers of 1975 will generally be backward compatible at an object code level to computers of today. Their designers do not want to make

them so; the computers become more complicated and inefficient. But the users absolutely must have backward compatibility, and what the users universally want, the users get. This compatibility requirement will, of course, be another one to which a variety of types of firmware can be applied. Conceivably the systems of 1975 will be able to function like the 360's of today, or even like the 1401's, without disastrous loss of efficiency.

### user needs will determine future technology

Now we have briefly toured each of the major technological areas which will contribute components and tools to the MIS computer system of 1975. How will they be assembled; what will the system look like? Not everything that is technologically possible is actually realized, and there are infinite variations in the way components can be assembled. We believe these uncertainties can be resolved by considering another factor, the needs of the users. Computer manufacturers' are competitive and pragmatic, and they try hard (believe it or not) to be aware of the needs of users and to respond to them. I will therefore present our perception of the primary needs of MIS-oriented computer users, in the belief that these are the major parameters governing the assembly of the new components into systems. They are:

*Simpler programming.* Any manufacturer who can simplify the user's problem of developing the data bases and programs for integrated information systems will have a powerful competitive advantage—and they all know it.

*Simpler operation.* One of the excellent ideas of MIS is that the user will interact directly with the system, but this will never be realized until he is provided with less complicated means of doing so. The programmers and operating staffs also have a problem. Today they are forced to struggle with complex job-control languages which they find wasteful, error producing, and irritating. Simplification of these is highly desired.

*Higher operating efficiency.* Measured overheads of operating systems (i.e., percentage of machine time consumed by them) range between 20% and 80%, with the most versatile and easy to use systems having the higher overheads. This is a critical problem; unless a reduction of operating system overhead is accomplished, the spread of MIS will remain severely constrained.

*Lower over-all cost.* Naturally users would always like computer systems to be cheaper, but costs are especially high for systems capable of handling large, complex MIS, where the data bases are extensive. Today a configuration capable of meeting the MIS needs of a large organization may easily cost \$5 million or more; obviously no mass market can develop as long as this is true.

*Higher reliability.* I need not dwell on this. We all realize that the reliability requirements for on-line systems (on which the operation of the business depends) are orders of magnitude higher than those for batch-processing systems. In fact, every currently operating on-line system I have seen that performs vital operations includes duplicate cpu's, even though one is sufficient to do the work. Surely this is not generally tolerable.

Your list of MIS user needs may differ from this one. However, we have developed this from studies of so many individual cases that I venture to assert its general validity. With it in mind, then, we are in a position to combine the components and tools of 1975 into an optimum processing system.

(Continued on p. 119)



WE ARE PLEASED TO REPORT THAT THE 70's AND THE 4th GENERATION COMPUTER ERA MAY NOW PROCEED.



**THE TAPE IS READY**

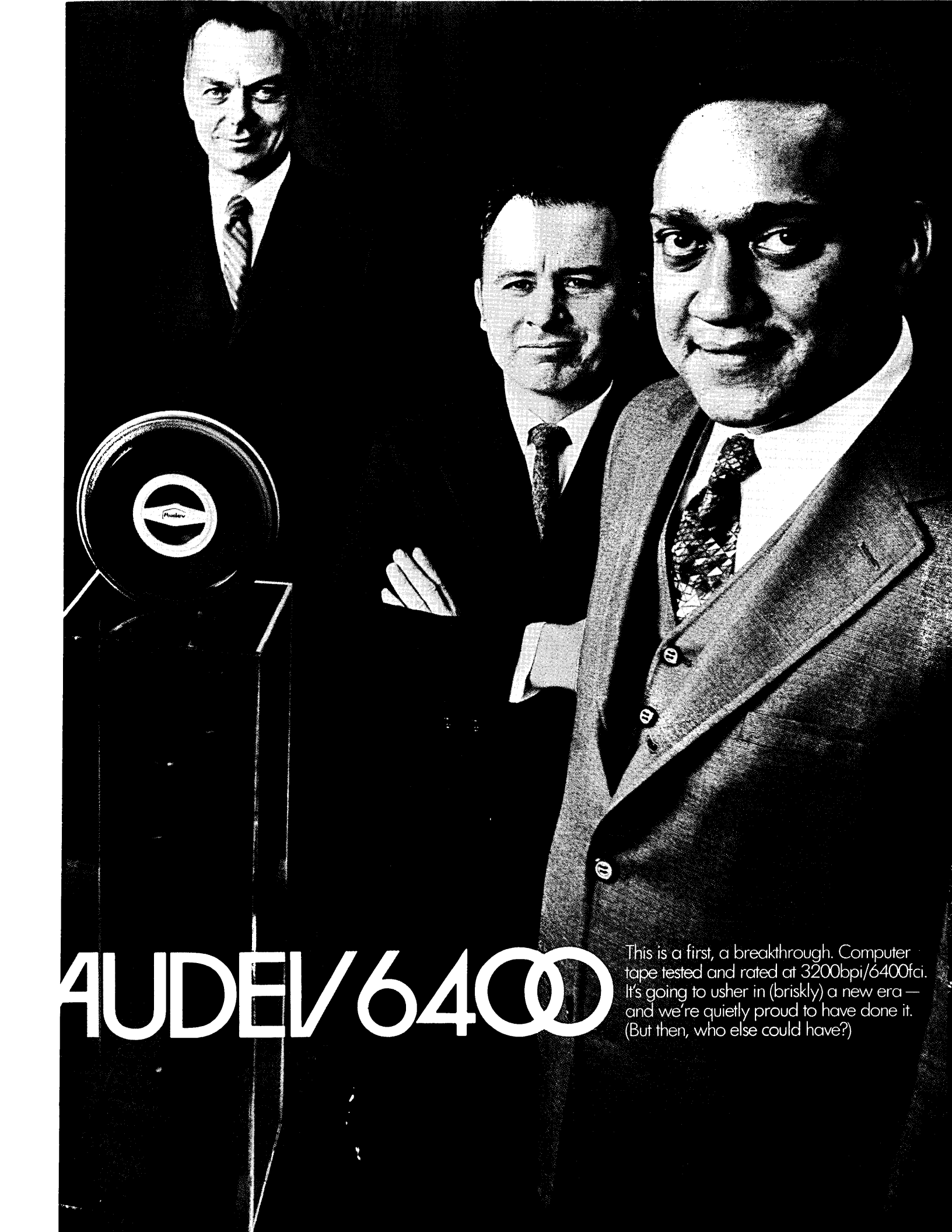

# AUDEL/6400

This is a first, a breakthrough. Computer tape tested and rated at 3200bpi/6400fci. It's going to usher in (briskly) a new era — and we're quietly proud to have done it. (But then, who else could have?)

We give you 6400 fci: twice the capacity of anything yet developed in the present state of the art.

It's brought to you by the people who concentrate on electromagnetic tape — and progress — and nothing else.

We'll also give you a complete technical report — at no obligation — on the high energy computer tape that permits a so much better byte packing potential.

Audev 6400 will let you store twice the information in the same amount of space.

Our thin line canister will save you an additional 33% of space in your library.

Audev durability will enable you to employ greatly increased transfer rates and tape speeds.

It will work on your present equipment; at the same time, it prepares you for the fourth generation systems to come.

All these marvels are made possible by Audio's engineering developments — in both binder systems and milling processes.

Think of it. Twice the capacity at higher speeds. In less space.

Clip the coupon for all the information on Audev 6400. The new era computer tape. And prepare for the best.

Audio Devices, Inc.  
(A subsidiary of  
Capitol Industries, Inc.)  
100 Research Dr. Dept. 6400  
Glenbrook, Conn. 06906

Please send complete data on Audev 6400.

Name \_\_\_\_\_

Company \_\_\_\_\_

Street Address \_\_\_\_\_

City \_\_\_\_\_

State \_\_\_\_\_ Zip \_\_\_\_\_



Fig. 4 presents our concept of such a system. It incorporates two or more identical cpu's as needed for optimum distribution of workload and for reliability. Each is about as powerful as today's Model 50 or 65, and not very different. Either of the cpu's could perform all the system's functions—system control functions using pure software, and processing functions. Normally, however, they share the processing, and the system control functions are assisted by several specialized units. A paging mechanism is likely to be available which converts the actual hierarchical memory organization into a virtual, homogeneous one. Associative task control storage is also likely—to associate interrupts with a variety of asynchronous operations without requiring

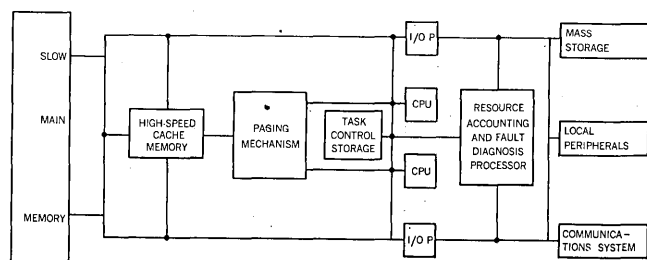

Fig. 4 MIS-oriented system of 1975.

laborious and time consuming software monitoring. A high speed cache memory, using semiconductor devices, stores all key software and system descriptive data. As I noted before, these are not necessarily the only specialized units. Pushdown stacks, and a variety of other devices we have not yet conceived of, may also be available. However, the function of all of these is the same: to attain higher operating efficiency for system software which can equally well be operated by either of the cpu's, though more slowly than with the specialized devices.

This requirement results from a combination of reliability and cost considerations. Reliability requirements dictate that we cannot depend on the availability of any one of these specialized units, and cost considerations dictate that we cannot duplicate them all, since they will undoubtedly be expensive. These units are analogous to the power steering in a car. They provide high-speed assistance to system management software functions, but are not essential to the system's operation because backup is provided by software operating in the cpu's.

The memory cost-performance curves in Fig. 3 indicate that a two-stage hierarchical working memory is likely to be used. Thin film (or possibly still core) will be used for a large, slow, main memory (divided into several banks for efficiency and reliability), and semiconductor devices will be used for the high-speed cache memory. To the user there will be no distinction; the paging mechanism will make the memory seem to be homogeneous. As time passes, the cost of semiconductor memory will decrease, and probably some day the memory will, in fact, become homogeneous; but we do not see this taking place prior to 1975.

We think such systems will incorporate a separate resource-accounting and fault-diagnosis processor. These internal monitoring functions could perfectly well be performed by one of the main cpu's, but there might be a relatively large loss of operating efficiency in doing so, and there would certainly be greater risk because the unit doing the testing is one of the units being tested. It may be simpler, more effective, and cheaper to use a minicomputer costing only a few thousand dollars for storing and execut-

ing the system monitoring software, periodically examining the status of various key measures of system performance, and stimulating it to execute certain standard diagnostic routines.

We believe the system will incorporate several autonomous I/O processors (at least two for reliability, perhaps several more) that are capable of managing communications with the mass storage system, with the local high-speed peripherals, and with the communication system. From the points of view of software and reliability it would be better if these processors were identical and interchangeable, but the variation in requirements imposed upon them may still indicate a degree of specialization.

Finally, as noted earlier we believe the several classes of peripherals will appear much as they do today, though with improved performance. In the mass storage area in particular, the higher density of storage is likely to lead to a very significant improvement in system cost-effectiveness.

#### future costs and capabilities

Obviously such systems will still be expensive. Not only do they incorporate multiple processing units, but also the specialized system control units needed for system efficiency. Over-all, there are likely to be several times the number of circuit elements in such systems than there are in comparable systems today. However, reductions in component costs will be so great that we think they will overbalance the increase in system complexity and produce a net decrease. Our best guess is that such a system, with relatively large file storage, would have a purchase price somewhere in the range of \$1.5 to \$2.5 million.

As you can see, the capabilities of this system will be considerably different from those of today. When it is used for batch processing, considerations of I/O device performance and channel capacity will still predominate, and the system will probably not have much more throughput capability than those of comparable cost today. On the other hand, used for mixed-mode processing of batch, remote batch, and interactive foreground operations, the system will be tremendously improved. It will adaptively and efficiently intermix these modes, even though all may involve file reference. It will incorporate "graceful degradation" in the event of failure of any central component. It will perform self-diagnosis, informing the operator of the difficulty, and be capable of reconfiguring itself to handle the total workload at reduced efficiency regardless of which component failed. It will generate its own performance and billing statistics. (Does this also mean that it will be capable of simulating the effect on its operations of adding or deleting a specific component—of "self-simulation"?) It will respond to simpler programs, inquiries, and directions by using implicit brute-force methods for processing and by performing housekeeping functions automatically without operator intervention or even knowledge.

In summary, such a system is not really very different from those of today. It is an evolutionary outgrowth of devices and techniques now in use or beginning to be in use. Most manufacturers will probably still call such systems members of their existing families. On the other hand, by sacrificing part of the cost-performance improvement implicit in the new components in order to gain higher efficiency and generality, it will have become far easier to use. As a result, the present problems impeding the development of MIS should be greatly reduced. Any user having the confidence to conceive of such a system should have no difficulty implementing it—and this, I submit, is all we need. ■





# The secrets of an 8 yr. old fast girl.

At "Show n' Tell" at school,  
I told about my Daddy's  
new computer.

I went to his office  
on Saturday to play and I  
saw it.

It's not really a computer,  
Daddy said.

He said it was a Scan-Data

machine that reads things.

All kinds of things. Letters  
and bills that the mailman  
brings. The tiny words  
in the telephone book. Big  
words, like the way I  
print on a piece of paper.

Daddy let me run the  
Scan-Data.

I took a whole lot  
of pages written with a  
typewriter. And I put them  
on a shiny tray.

Then, I pushed a button.  
And guess what? The pages  
disappeared into the machine.

Daddy said the machine  
was reading all the words.

And remembering every  
single word it read.

He said that what I did  
was faster than all the big  
keypunch girls he had  
before. And he said I didn't  
make even one mistake.

I like my Daddy.

He likes Scan-Data.

Scan-Data Corp., 800 E. Main St., Norristown, Pa. 19401 (215) 277-0500

**Scan-Data:**  
**Keyless**  
**Data Entry**

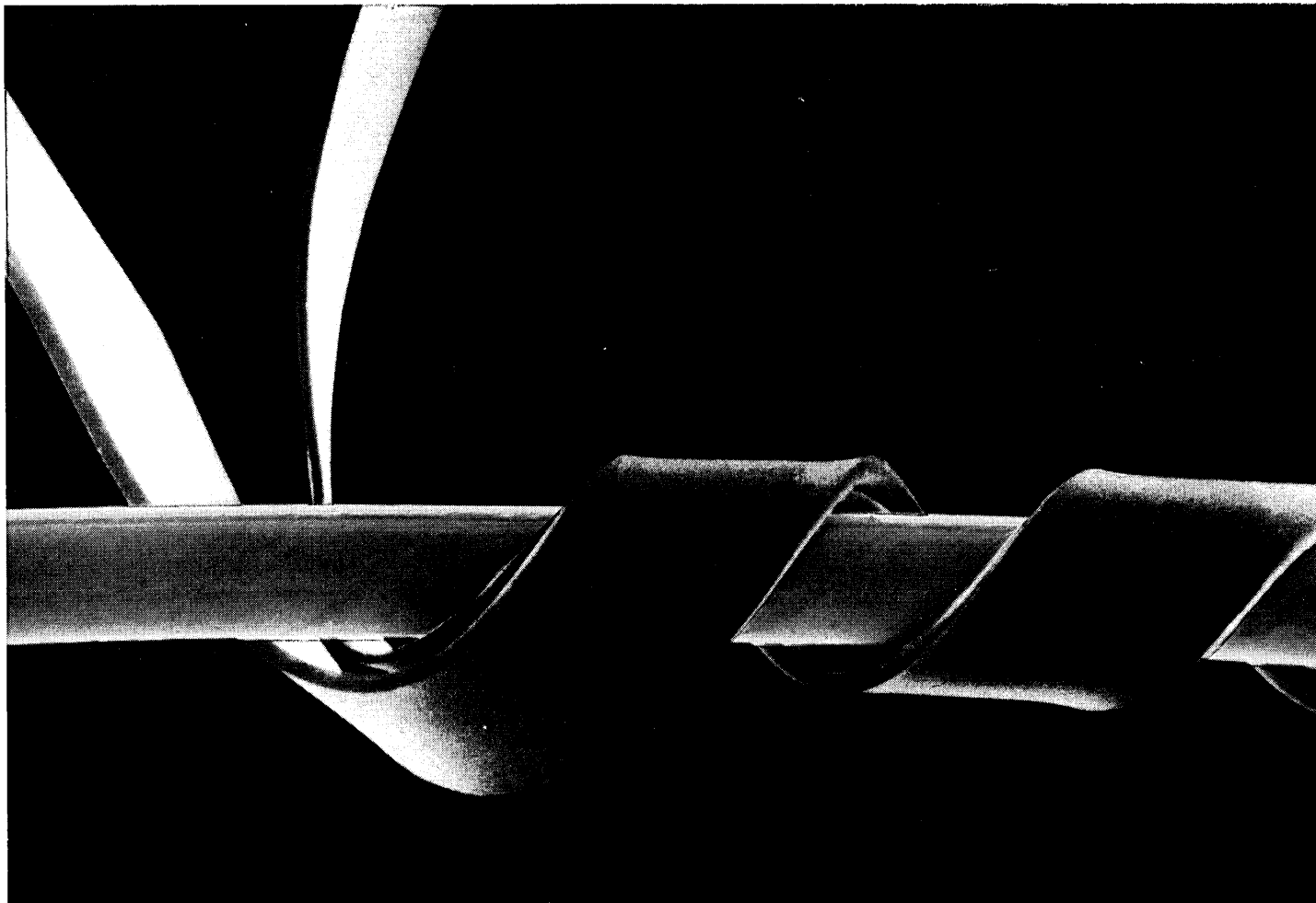

### Customizing a magnetic alloy

Bell Laboratories scientists have custom tailored a magnetic alloy for the "piggyback twistor," a memory device used in electronic switching systems.

In this device, metal tapes (enlarged 225 times above) are wound into a tight spiral—subjecting them to considerable mechanical stress. The magnetic properties of the alloys must be essentially independent of such stress. That is, they must have low magnetostriction. In addition, the outer tape must be magnetically "hard"—with high coercive force (resistance to change in direction of magnetization). And finally, it must be ductile enough to be formed into tape. No known alloy had this combination of properties. So, E. A.

Nesbitt, G. Y. Chin, and D. Jaffe of Bell Laboratories made one to order.

Tailoring the new alloy for the outer tape required a precise knowledge of the relationship between the magnetic behavior of materials and their structure. So, the Bell Laboratories scientists began with 90% cobalt and 10% iron, a composition they knew had the necessary ductility and low magnetostriction—two of the essential requirements. But, since the coercive force of the composition was inadequate, they were faced with another knotty problem.

To solve it, they went back again to a basic principle—a precipitate in an alloy impedes the motion of magnetic domain walls when a field is applied to reverse the magnetic

polarity. With that foundation, the scientists formulated a composition of 4% gold, 84% cobalt, and 12% iron. (The gold is the precipitate.)

When this new alloy was cold-drawn to produce a 97.5% reduction in cross section and then heat treated, its coercive force increased to the point required for piggyback twistors.

By simplifying the manufacture of piggyback twistors for use in the electronic switching systems now being built by Western Electric, the new magnetic alloy puts basic research in metallurgy at the service of telephone customers.

**From the Research and Development Unit of the Bell System—**



**Bell Labs**

# THE MINICOMPUTER— DOES IT FIGURE IN LARGE SCALE PROCESS CONTROL?

still another market

by Ed Abrahamson

Without regrets for the bygone maintenance horrors of my 1961 vacuum-tube-analog-computer project, I stood somewhat awed at the SJCC and pondered an example of concentrated smarts on three circuit boards. It was a minicomputer; 10K dollars for 8K core, stripped for the oem.

These precocious youngsters of the i. c. flat-pack era are multiplying at a rate worthy of a well-run hamster hatchery. Their small packages belie their amazing functional capability. Their builders (those that furnish them with process i/o) advertise process control capability. Does that capability, however, apply to large scale process control as we know it today?

## confronted by eggs: how many baskets?

Let us look at an example in Fig. 1 of a medium/large process control system. It is configured to the technology of currently installed on-stream digital computers and i/o gear.

Because of the critical nature of this continuous process (a five-unit oil refinery), this DDC application is distinguished by redundant i/o data busses, critical modules, and cpu's. The user, furthermore, furnished redundant control-room air conditioning and redundant mc-set power supplies. (Alas, there were times without redundant program-

mers.) Within the context of existing art, the system's designers did a creditable job of spreading their eggs around to the number of baskets, thus lessening the effect of

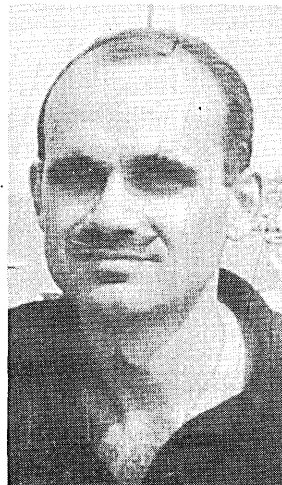

Mr. Abrahamson is a computer control consultant in Sharon, Mass. He has worked on several computer-control projects, the latest being a five-unit oil refinery DDC application. He has a BA and a BSEE from Columbia Univ.

Two views of a zig-zag test pattern and Hebrew text are shown. The overall view is preserved in the lower part of the scope. A magnified view of the picture is shown in the upper part. The part being magnified is in the rectangle inset. Note that the lines in the zig-zag pattern are clipped off in the magnified view.

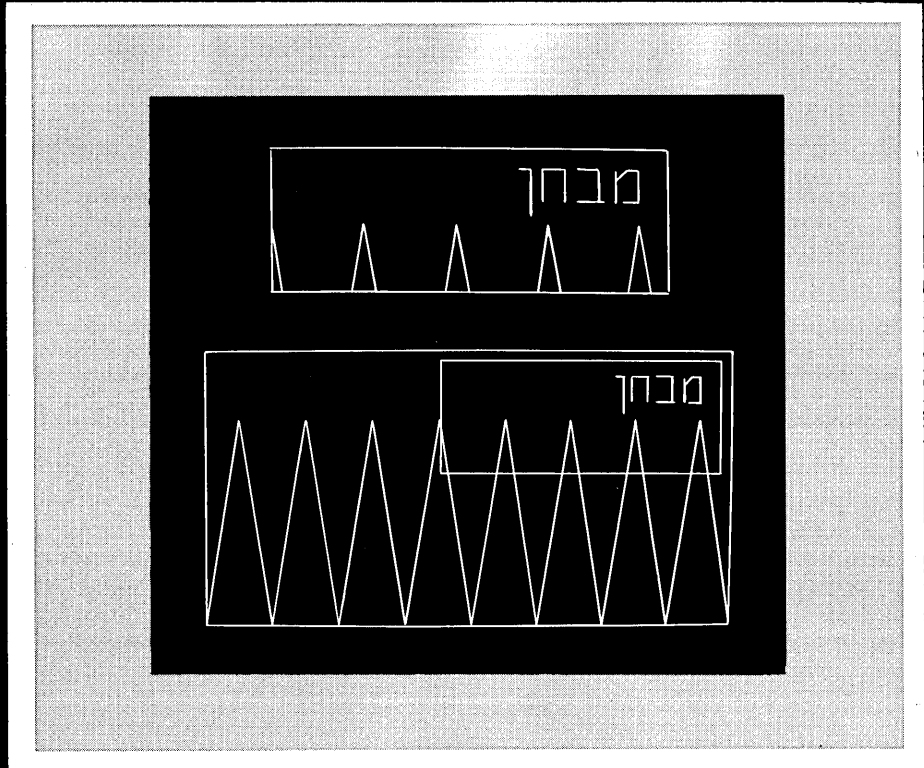

## THE LDS-1

### DOES AUTOMATIC MAGNIFICATION AND WINDOWING... ELIMINATES COMPLEX SOFTWARE

The Evans & Sutherland Line Drawing System-1 automatically magnifies any picture display. You can examine minute details or shrink the picture to show an overall view.

Changes in scale are instantaneous and continuous, allowing the viewer to easily relate fine detail to the entire picture. Expansion by a linear factor of 256 times is available. On some systems, the linear magnification factor can be as great as 4,096 times.

A 12-inch scope can window a drawing that covers an acre and, on some systems, it can go to nearly a square mile.

During expansion, parts of the display move off the scope. LDS-1 automatically eliminates these lines from the picture and automatically computes correct end-points for lines that are only partly

displayed. Thus, the scope is a true "window" and the frame is provided by hardware. Complex and expensive windowing software is eliminated!

Expansion and windowing are done digitally to insure complete accuracy over the full range of expansion. Because LDS-1 can return its digital picture output to memory, it can prepare any picture seen on its own scope for presentation on existing scopes, microfilm recorders or plotters without additional software.

With LDS-1, you can divide the scope face into separate areas and display a different picture in each area. Or you can display different views of the same picture in each area.

No wonder software for LDS-1 is so simple. *All of the hard parts are done by the hardware!*

For more information, write: Evans & Sutherland Computer Corporation, 3 Research Road, Salt Lake City, Utah 84112.

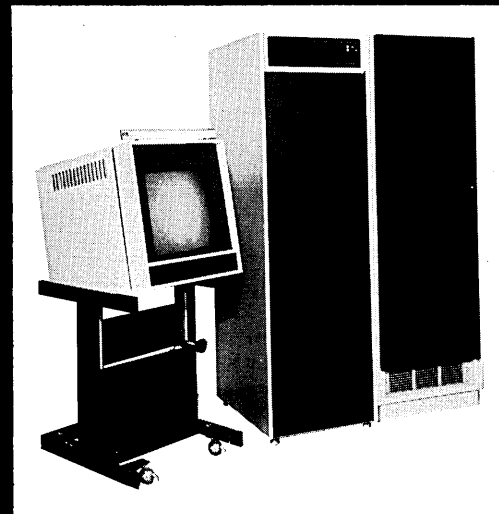

EVANS & SUTHERLAND COMPUTER CORPORATION



critical module failures to an acceptable level. It was a step in the right direction.

The result was a sophisticated system security network with self-checking hardware and software diagnostic schemes. The lower machine normally performs the DDC controller functions and keeps the upper or supervisory machine updated on a whole class of changes that it must know so that, if it must take over control due to a failure, the transfer will be smooth and bumpless to the process.

Fairly elaborate criteria were developed to detect malfunctions, evaluate their importance, and if necessary declare the kind of failure that caused automatic takeover.

Enter Tiny Smart 2000 (assumed proven and fairly reliable) with sidekick Boob Tube. Can they compete with Abundant Redundant and his two operator panels? Not alone certainly; but with guidance from above our fragile eggs might be spread amongst a few more baskets with reasonable functional compromise and, in the process, simplify our system security tasks. Consider Fig. 2 where we propose a conventional hierarchy configuration.

Each unit in the plant has its own controller, printer, and crt operator console. Where functional economies in manpower and equipment are desired, the crt and printers can be shared by two or three units. The operator would select the unit on the keyboard for crt use, while the controllers themselves can switch the printers on a first call, first served basis.

In a system of this size (about 200 valves) there are a certain number of the 900 to 1000 analog inputs that are worthy of logging, yield/material balancing, etc., and are not needed for access by the operator. These might be directly multiplexed by the supervisor computer without need for memory access to the all core unit computers. Or they might be mixed with those measurements that are required by both supervisor and unit computers. These measurements are acquired by the unit computers. This

would necessitate a communications module with multiplexing capabilities to the various unit machines. The communications multiplexer itself could be a stripped-down minicomputer even smaller than the unit computers.

**the major advantage**

The major advantage of this decentralized configuration is the complete independence of each unit from failures in other units. Failures in the supervisor and communications module are of course shrugged off by control machines in either configuration. Since the cost of the computers and centralized I/O subsystems such as analog-to-digital conversion has gone down considerably, it is the per-point process interface hardware and termination facilities, etc. that are more influential in large scale system hardware cost. This includes A/D per-point multiplexer boards, D/A valve driver boards, per-point contact sense and control output boards, RTD bridge interfaces, etc. It is these I/O point numbers that do not change from one system configuration to another for a given application. Engineering service charges are also more influenced by these numbers than other considerations.

**installation, startup, maintenance**

The autonomy of the various units spills over into the all-important subjects of installation, start-up, and maintenance costs. The first two affect both user and vendor. For the first time, because of the functional package density of the miniaturized electronics, it is possible to think of maintenance, after a period of run-in, to be taken over completely by the user in the unit computer and I/O area.

The fact that a complete A/D conversion function is nowadays found on one circuit board rather than spread into two full card rows is an example. The unit computer itself and the crt operator panel are of such a size and cost that electronic mechanics rather than real troubleshooters can replace an entire unit in minutes and send it back for higher-echelon or off-line repair. (This is the approach being taken by the armed forces with the "new" electronics.) If the valves hold to their last position after a failure,

Fig. 1 Abundant redundant configuration, 1965 drawing board.

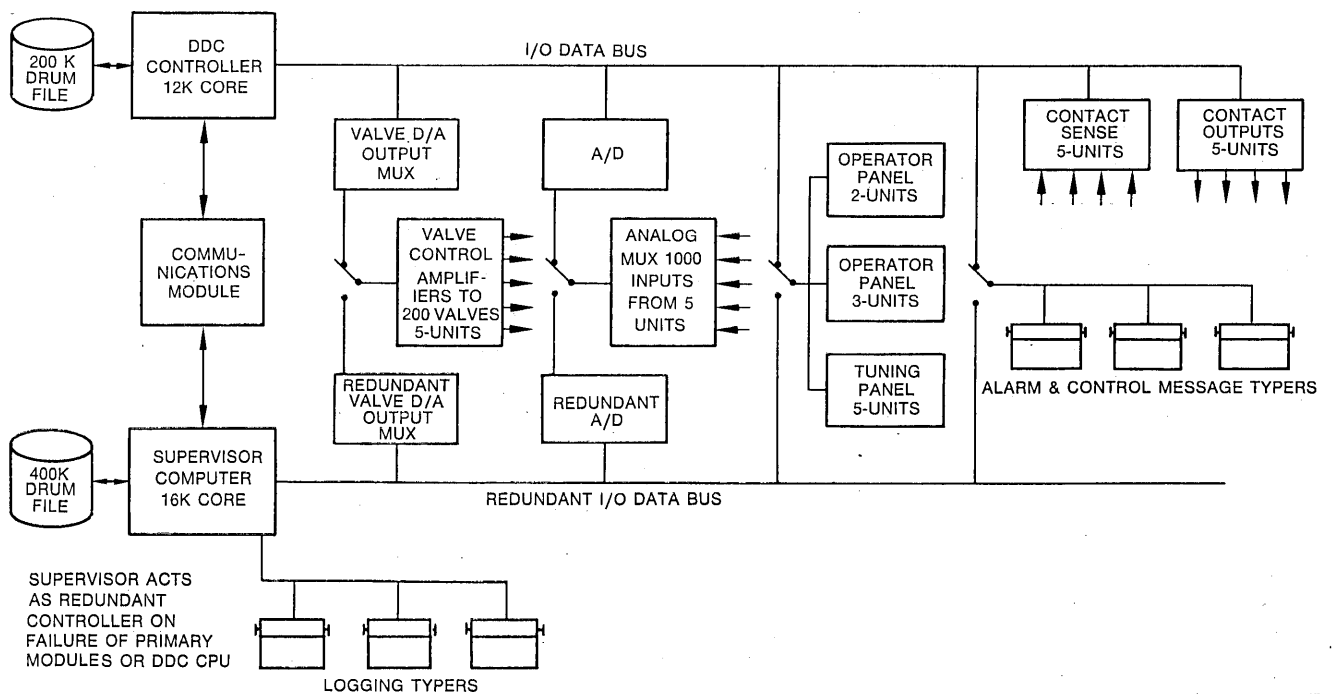



as they are designed to do, an operator can control a single unit in the manual mode of operation for 10 minutes or more in this continuous process. If necessary, analog back-up for DDC control can be implemented for critical loops. A centralized system cannot be handled in the manual mode for very long because of the sheer mass of loops involved. In the first configuration described, however, the supervisor computer kicks out lower priority programs such as logging routines and takes over control for the entire refinery on failure of the DDC controller. Repairs must be made in place, however, with certain risks of interaction due to various shared equipments.

Installation and start-up is a very costly affair in a large centralized system. Grounding problems, leakage paths, and general interactive hardware and software complications in my opinion are an exponential, not linear, function of the degree of centralization and of the process I/O quantities. The unit approach makes modular start-up and installation a distinct reality at a savings.

**data base management**

The actual preparation of the large data base required for our example is done by the supervisor computer in both configurations. Whether it is initially done off line by a fill-in-the-blanks technique or later modified by conversational mode on-line languages, the programs are resident in the supervisor computer and the data base for all units is saved in the supervisor's bulk storage.

It is then available for single-source data-base refueling (via the communications module) for unit start-up or restart after a failure. (For batch process applications the

sequencing control might be considered as part of the data base.) Process initialization routines for running on fresh data base are part of the unit computers' library. The temptation to complicate communications with routines for updating the supervisor computer of many changes made down at unit level should be resisted. A simpler solution might be for a data-base snapshot request to be made once a day by the supervisor computer of each unit controller. Operator set-point changes would be an exception to this rule and should be updated. (For batch process applications there are other complications related to the state of a particular batch in a unit at the time of a failure.) In order to keep communications simple, adaptive control routines in the supervisor computer can be designed to calculate effective secondary set-point changes rather than operate on per-loop tuning parameters. Optimizing control would also be done in the supervisor computer and result in set-point changes.

**program security**

Control program security is a worry that has resulted in various solutions. The minicomputers are available with ROM (read-only memory) options for a certain part of their core. Short of this, a "refueling" from the supervisor computer could include an entire 8K dose of programs and data base when required.

**decentralize and simplify**

The above examples illustrate one application with two solutions. There are other solutions available to the designer with the minicomputers and crt panels as building blocks. They were practically unthinkable a year-and-a-half ago because of cost and availability. I'm interested in the designs that decentralize and simplify. These are two goals that are not incompatible. ■

Fig. 2 Hypothetical mini-mod configuration, 1969 drawing board.

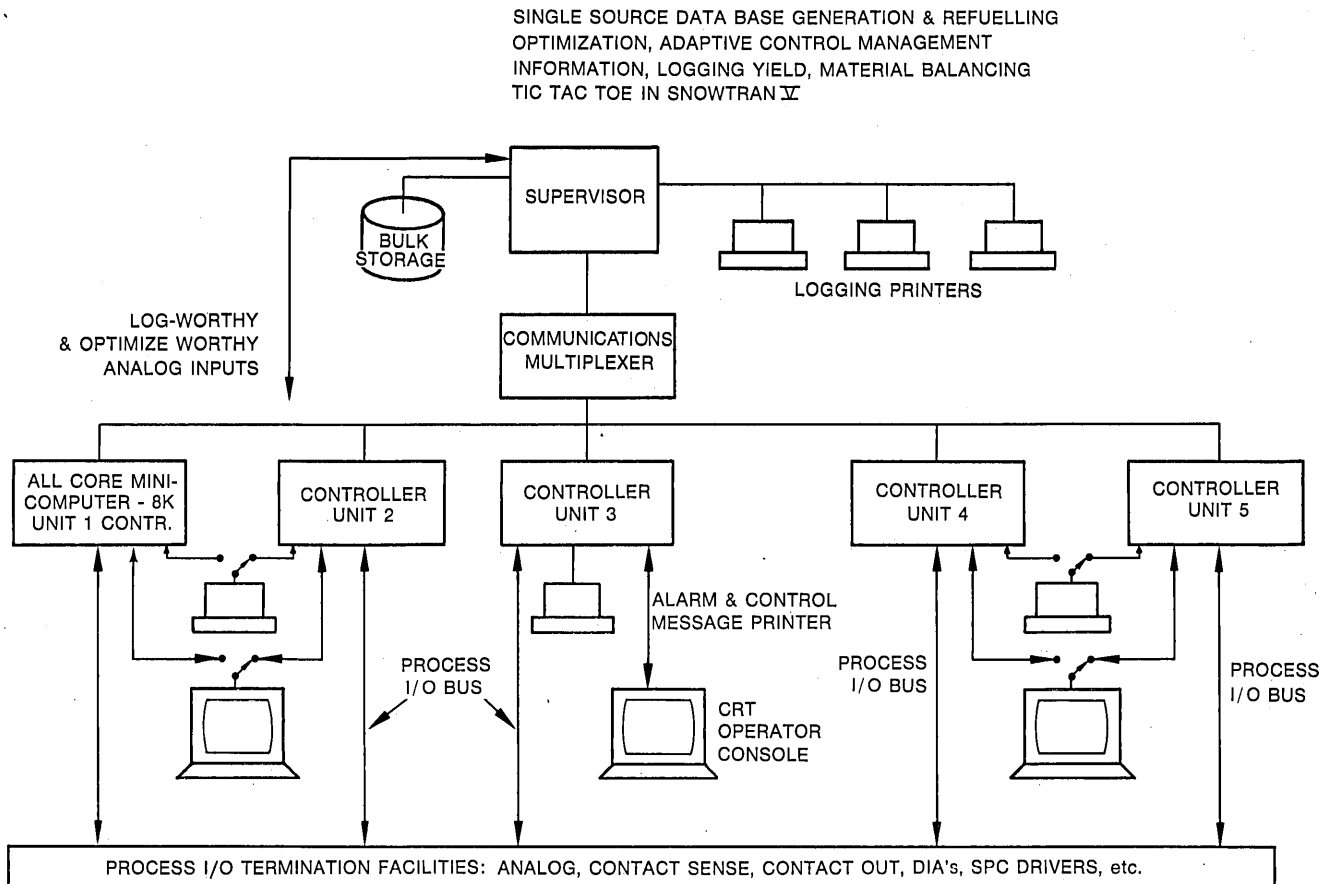

# 9600 or 7200 bps modems with continuously adaptive fully automatic equalization only \$9,950 each

The Rixon SEBIT-72 and SEBIT-96 data sets are ready for shipment. They're perfect for increasing core-to-core transmission rates, improving throughput in remote batch applications, multiplexing two medium-speed channels, or similar applications. They'll make great contributions to the efficiency of your lines, personnel, and equipment. And they're available with your choice of EIA or MIL-STD interfaces.

Our new Applications Bulletin on the SEBIT-72 and SEBIT-96 will give you the whole story, including test results. If you're already moving too fast to wait for a copy, call us collect. We'll move as fast as you can.

Experience counts. It means you can count on Rixon.  
*The Data Communications People*

Rixon Electronics, Inc./a subsidiary of United Utilities, Incorporated, 2120 Industrial Pkwy., Silver Spring, Md. 20904/(301) 622-2121





*This face  
could change your  
life.*

This is the Irascope. By Spiras. Designed to show you how beautiful CRT data characters can be. With a flicker-free, safety bonded, anti-glare viewing screen that you'll never get tired of looking at. Wonder what's behind that pretty faceplate?

A high-resolution monoscope, generating up to 80 closed curve 0.25" high characters per line in any font you specify. Complete editing, with tab and format protect. 1000 character storage in a 2000 character field.

Upper/lower case. Selective erase. Selective transmit. And maximum versatility as a systems component. The Irascope will interface with any modem, any computer (including our powerful Spiras-65). Use it as a teletype replacement for time-share terminals.

Or as "Scope Tape" with cassette or IBM-compatible tape options in standard mode.

That's just part of what you can do when you get your hands on the Irascope. Call us; we'll give you a better look.

You're going to love what you see.

Corporate offices:  
332 Second Ave., Waltham, Mass. 02154



 Spiras Systems, Inc.  
Affiliate of  
**USM Corporation**

An affiliate of USM Corporation. USM is a world-wide 400-million-dollar designer and manufacturer of systems, aimed at improving the productivity of manufacturing and service industries.

# **publishers**

**Thinking of going on-line  
to your**

# **computer?**



**Would your operation be  
more productive if you used  
a display terminal  
designed to...**

- edit text
- layout pages and ads
- fit headlines or cutlines
- enter advertising
- schedule production
- check credit
- estimate jobs
- answer customer inquiries
- enter accounting data
- provide management information

**You can use the Computer-Optics CO:70 Display Terminal  
to perform these jobs because it has these features:**

- 88 character set
- standard typewriter keyboard
- upper/lower case A-Z
- numerals 0-9
- 26 symbols for custom design
- 3000 character screen capacity
- built-in editing functions
- software and interfacing for IBM S/360, IBM 1130, PDP 8
- local and remote operation
- P31 phosphor
- human factored for ease of operation.

***and a price that's hard to beat.***

**For more information on how CO:70 can go to work with your computer,  
please contact Mr. E. J. Shaughnessy, Marketing Manager, Computer Optics  
Inc., Berkshire Industrial Park, Bethel, Conn. 06801 or phone (203) 744-6720.**

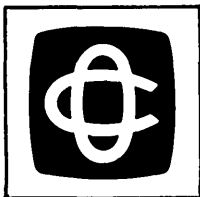

Specialists in display systems  
**Computer  
Optics**

# Datacraft's Master Plan:

**organize  
the world  
24 bits  
at a time!**

Datacraft is now delivering the fastest 24-bit general purpose Digital Computer available today. Our DC 6024 overshadows many 32-bit machines that limp along behind fancy gingerbread control panels. We take advantage of the simplicity of our 24-bit CPU design and our superspeed memory to run circles around several of our larger cousins, both price-wise and throughput-wise.

Datacraft's DC 6024 is the computer with 600 NSEC full cycle time. This is the processor with 120 generic types of hard-wired

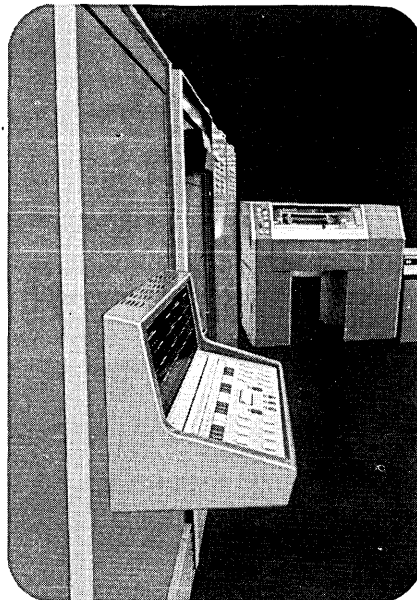

instructions and more than 500 operation codes. Ours is the CPU that can give you up to 72 levels of priority interrupt and the capa-

bility to handle up to 448 different I/O units. With a transfer rate of 40 bits per microsecond, you'll be kept plenty busy feeding our DC 6024.

Datacraft is in full production of DC 6024 Digital Computers, and your deliveries can begin 60 days from date of order. Price for the basic unit, without main frame options, is \$53,900.

*Today The World  
(24 bits at a time).*

*Tomorrow Someplace Else  
(24 bits at a time).*

## *Datacraft*

P. O. Box 23550  
Ft. Lauderdale, Fla. 33307

North East (201) 542-2860 • Midwest (314) 961-9927 • West (213) 377-5583 • South East (305) 831-5855

# A SIMPLE-MINDED DOCUMENTATION SYSTEM

by Robert C. Maegerlein, Sr.

It is a generally recognized fact that we in the systems department, who pride ourselves on our talent for designing and implementing sophisticated real-time systems, elegant time-sharing operations, and blue-sky management information systems seldom use these talents on our own internal environment.

We design the MIS because management needs timely, accurate, and precise information. We ourselves are content with out-of-date, inaccurate, and vague documentation. We hook up remote devices via telephone lines to a computer to facilitate information flow, yet we ourselves rely on word-of-mouth transmission of detailed program specifications. We justify the cost of elaborate third-generation computers, exotic remote-terminal devices, and high-speed direct access storage devices because the nature of a MIS requires it. Yet, for whatever documentation that we have, we rely on hand-scribbled notes and, sometimes, a typewriter.

The reasons for this paradox are multiple. But probably the real reason is that we are so used to thinking *big*, that *simple* solutions to our own internal data management and MIS problems do not occur to us. When we do think about our problems, the solutions which appear are MT/ST (IBM tape-storage typewriter), cathode-ray display, DASD, and other sophisticated approaches. But, since management does not see any cost-saving (it exists, however, since inaccurate documentation costs money) in letting the systems department have any of these goodies, we grumble and complain and live on with inaccurate, untimely, or non-existent documentation.

## the answer is isis

The solution to the paradox is the development of a simple-minded yet effective Internal Systems Information System (ISIS), using the tools that we already have, namely, magnetic tape, computer, keypunch, and printer. The purpose of this article is to expose the simple steps that we took in developing ISIS at the Dial Finance Co.

Simply, these are the characteristics of our ISIS:

1. Documentation is on magnetic tape.
2. Input to the system is handwritten.
3. This input is keypunched, and the cards are run against the ISIS master.

4. Only pages that change are normally printed.
5. These pages are then Xeroxed and distributed.
6. The printer output updates the master specification copy in our library.
7. Only the lines that change a specification are input.
8. By means of the well-known add, delete, and replace functions commonplace to the program library maintenance features of assembly systems, two simple programs create and maintain the system.

In implementing the system, I anticipated that the first problem would be getting the keypunch department to keypunch from free-form documents. The first sheets that I took them for punching were carefully hand-lettered on a normal coding form. The next batch was hand-written on a coding form, but with each script letter carefully allocated one-per-column. I gradually became deliberately more careless so that finally what was written on a line of the coding form did *not* fit into an 80-column card. And this led to the final stage, handwriting on ordinary paper. By this time the



Mr. Maegerlein is presently the lead systems analyst with the Dial Finance Co. of Des Moines, Iowa, where he is developing and implementing a real-time system for processing loans, payments, and transactions for 400 Dial branches. Previous to this he worked for American Motors, after having taught high school mathematics and chemistry for five years. He has a BS in mathematics and chemistry from the University of Detroit.



girls enthusiastically welcomed this kind of work as a pleasant change to their normal keypunching of branch reports and loan records.

Thus, the problem that I thought would exist, namely hostility to change from the keypunch department, either vanished or never existed.

The backbone of ISIS is two programs, an UPDATE and a CREATE. The rules which the data must follow are simple and allow great latitude in formatting the documentation. They run in a dedicated real-time environment and, thus, do not take additional computer time.

Three types of control card specify each run: CREATE, UPDATE, and LIST. The CREATE processes the first document against an input master. The LIST function will print out all or part of a document already CREAT-ed. And the UPDATE card specifies, together with ADD, DELETE, or REPLACE cards which follow, action to be taken against specific lines of a document.

The format of data cards is critical yet flexible. This is the format of data cards:

```
CC 1 BLANK
CC 2-72 DATA (2-72 is all that will neatly fit on our 8½x11
specification paper)

.01 xxxxxxxxxxxxxxxxxxxxxxxxxxxxxxxx ... x
   xxxxxxxxxxxxxxxxxxxxxxxxxxxxxxxx ... x
   .01 xxxxxxxxxxxxxxxxxxxxxxxxxxxxxxxx ... x
   .02 xxxxxxxxxxxxxxxxxxxxxxxxxxxxxxxx ... x
       .01 xxxxxxxxxxxxxxxxxxxxxxxxxxxxxxxx ... x
       .02 xxxxxxxxxxxxxxxxxxxxxxxxxxxxxxxx ... x
```

A decimal point in cc's 2, 6, 10, 14 or 18 is required when starting a new paragraph, and a line is skipped under program control when this character is sensed.

These are the instructions we give to the keypunch department for punching the data cards:

1. Start each line where indicated. Columns are marked at the top. From that point, just keypunch what is there, leaving 1 space:

Between words.

After a comma and after a period except when the next character is a single quote. For example, IT IS CALLED 'RESTART.'

Before and after an =.

Before a - as in the example ADD -2.

Before a left quote, not after; after a right quote, not before. For example: WE WILL 'RESTART' THE JOB.

2. If the writing on each line will not fit (you may use cc 72 but no punching in 73-80) hyphenate the word and do the rest in the next card, starting in the same cc where the writing started on the line that was too long. Continue in the same card with what is written on the next line, unless that line starts with a decimal point. If so, start a new card.

3. Use your own judgment. This is like typing, except that you have to watch your own margin.

4. A drum card, set to skip to cc 2, and to 6, 10, 14, and 18 when you hit "skip," and setting a "skip out" at 72 will make things easier. If you have not finished a word when the card skips out, decide where to hyphenate, duplicate the card to that word, hyphen, and release. Finish the card in the next card and throw away the bad.

**how isis helps**

Some advantages of such a system are:

1. The system runs as part of our real-time environment and, thus, uses free time of the cpu and i/o channel. The only additional cost is keypunch.

2. It uses the programmer's or analyst's hand-written specification as input. No elaborate typing is necessary.
3. Programmers and analysts are already used to updating programs in much the same way that they update documentation.
4. Turnaround time from submission of sheets to keypunching to distribution of the Xeroxed copy is short.
5. The accuracy gained from trained keypunch girls and key-verification is much higher than from secretaries.
6. No retyping of lines that do not change is required. Thus, there is no change to the rest of the page and new errors do not creep in, as is the case when a secretary retypes a page.
7. Documentation is very professional looking.

We plan two refinements to the system. First, once all the documentation is on tape, it will be a simple matter to write a program which will search for key words—in our industry, such key words are "payment," "due date," "note amount," and so on—and prepare a cross index of key words-to-specification by page and line number. Manual preparation of such a list is too large a task.

Second, it will be an easy thing to change input from card to one of our IBM 1980 typewriter terminals. Update lines can be stored on disc until all updates are in for a given specification. An END message would cause this discarded information to update the master file and print the changed pages. Programmers could even make their own changes.

isis sounds like a pretty impressive thing. Imagine what the reader would have thought, however, had the title of this article been "An Internal Systems Information System." But we built the system first—simple-mindedly—and that was the key to its success. Then we named it—something impressive like isis—to hide the simple-mindedness. But perhaps it's not simple-minded, just *simple* and therefore *elegant*. And maybe it deserves a neat name like isis. ■

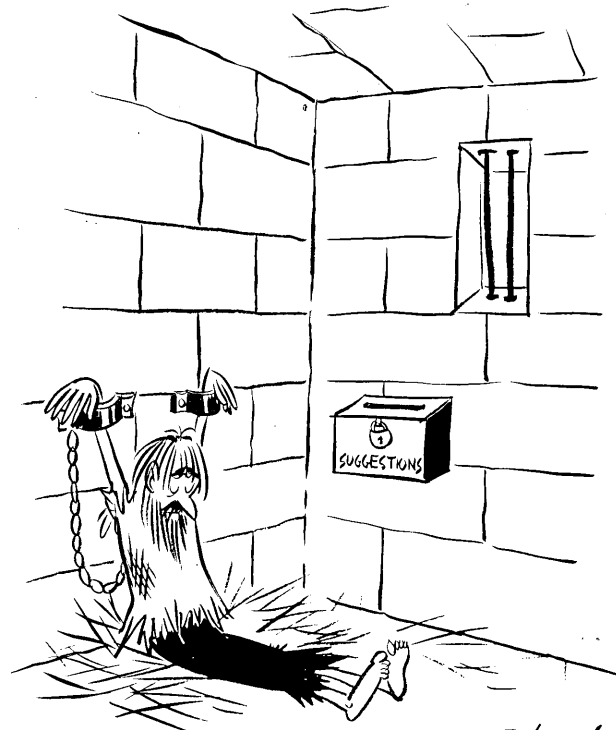

Richard ©  
c DATAMATION ©

# Planned paperhood (or) the care and feeding of your computer

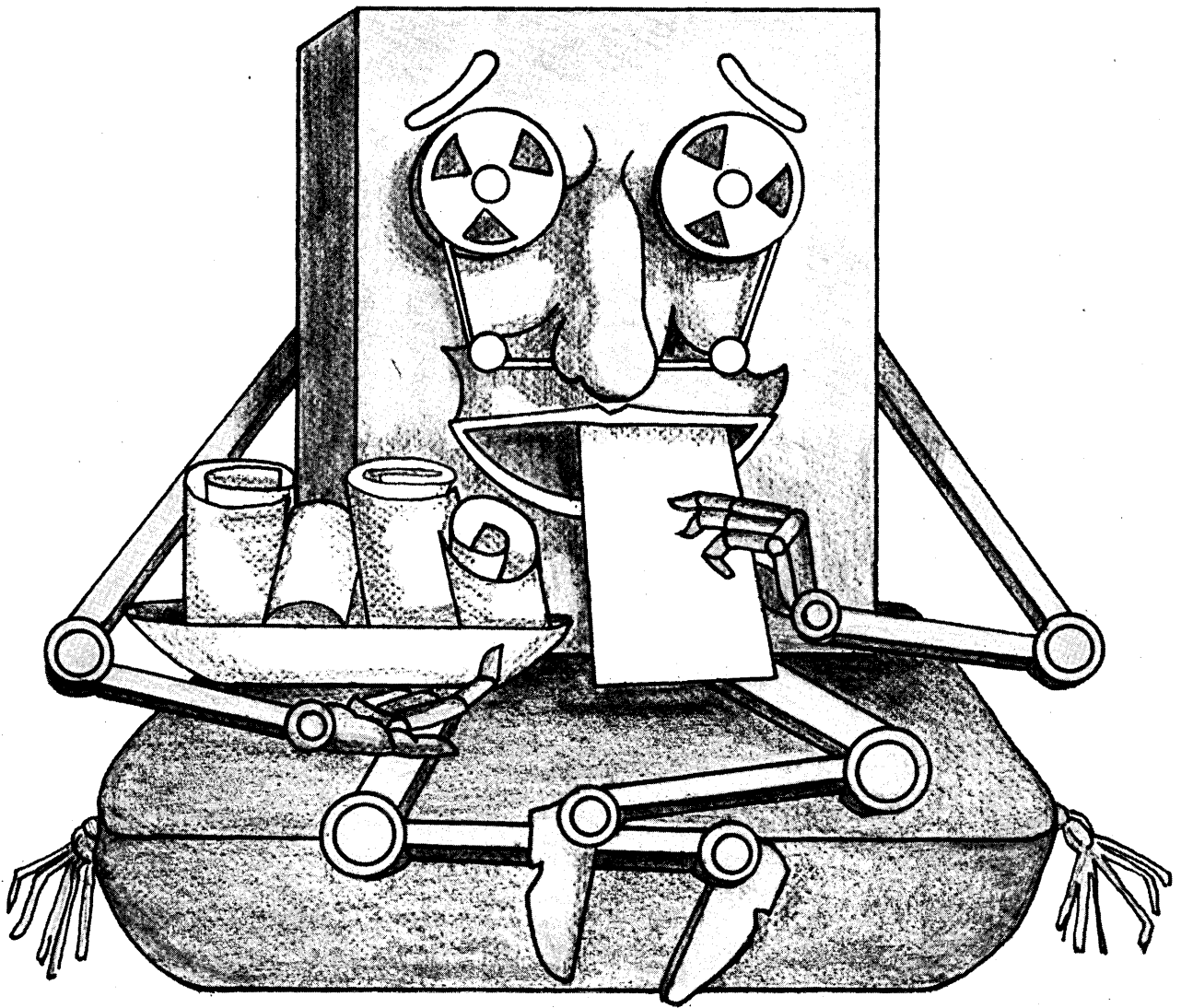

In many ways, computers are almost human. You treat them right and they'll treat you right.

When the people who feed your computer waste time searching, filing, storing, transferring or just plain moving around, you can expect late starts. And delayed output.

To turn on your computer faster, you need Planned Paperhood. It's a Remington Rand Customized System that's been tailored to increase your efficiency, streamline your operation . . . and yours alone.

Whatever the holdup: filing raw data, handling punched cards, protecting master tapes or inefficient work station procedures, our Planned

Paperhood specialists will find it. And then solve it right away.

No one offers a broader line of computer accessories: protective folders for master cards, Vis-U-Triever<sup>®</sup> units for alpha-numeric cross index, Lektriever<sup>®</sup> electro-mechanical filing system for tapes, cards or files, fire-resistant file cabinets, microfilm systems and more.

Let Remington Rand show you how better feeding can mean better feedback. For a free copy of our new "Planned Paperhood Workbook" and our Data Processing Accessories catalog, write Remington Rand Office Systems Division, P. O. Box 171, Marietta, Ohio 45750.

# The ABC's of Data Storage

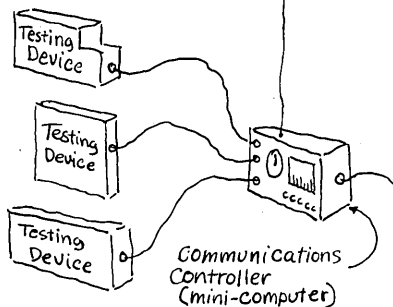
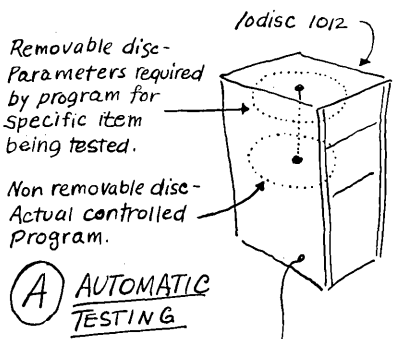

The IODISC 1012, with a removable disc in combination with a non-removable disc, has specific advantages in automatic testing applications. The removable IODISC cartridge provides storage for the test parameters and collects output data. The non-removable disc remains on-line for storage of the basic test control programs. The result: performance flexibility of two separate drives at a price "almost" as low as a single drive.

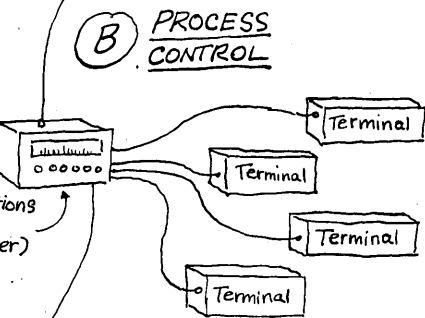
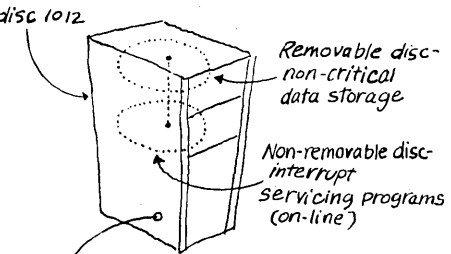
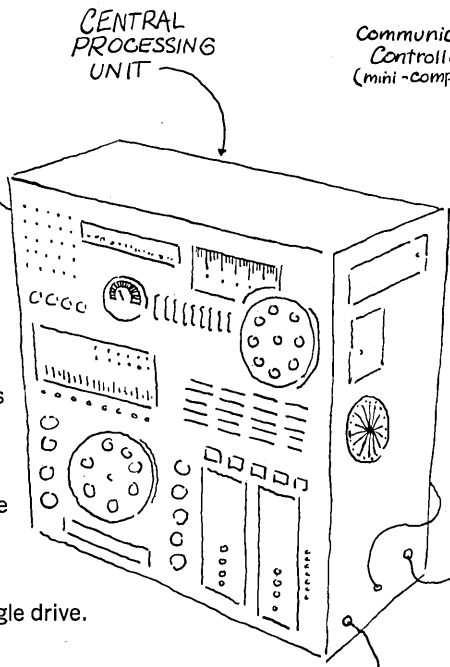

Many process control applications require that high-priority interrupt-servicing routines be on-line at all times. The non-removable disc of the IODISC 1012 provides for the storage of the operating system, the control program, critical "read only" data and interrupt-servicing routines. The IODISC cartridge provides off-line storage for lower priority programs and raw data. This combination of a removable and non-removable disc on a single drive gives the user increased system capacity and flexibility. And with substantial savings over the cost of two separate disc drives.

## C COMMERCIAL DATA PROCESSING

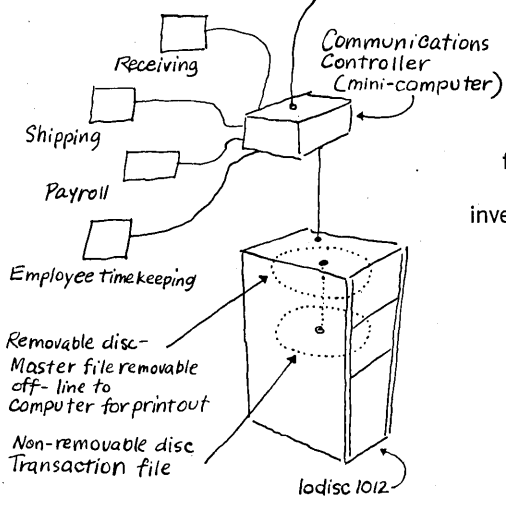

The IODISC 1012 gives increased system capacity and flexibility in order billing and accounting applications. The non-removable disc of the 1012 provides temporary storage for the by-product outputs of billing operations. Control and formatting programs are entered via the IODISC cartridge. At specified intervals the master file cartridges for inventory, accounts receivable and sales analysis are updated from the fixed disc. With a 2.7 million character capacity, the IODISC 1012 drive can handle the typical data processing operations for small business payrolls, inventory and invoicing. The IODISC 1012 is the "almost" drive — "almost" the performance of two separate disc drives and "almost" the price of just one drive.

**iomec inc**

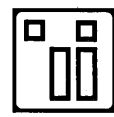

345 Mathew Street  
Santa Clara, California 95050  
(408) 246-2950

# Moore New Ideas for Data Processing

**Improve order service; get completed shipping labels as bonus**

When shipments require multiple containers, labeling those containers becomes a major bottleneck. A source of errors, too. Moore has a simple system that generates a 21-label batch as a by-product of preparing the shipping documents. System is so inexpensive, you can afford to throw away the unused labels. Ask about Idea #301.

**Keep parts lists current and error-free**

Where parts are both manufactured and bought from outside vendors, record keeping can be a nightmare. Especially with design changes and new models being introduced. Moore has a way to turn this task over to your computer so it is done quicker, more accurately, and at far less cost. It even lets you determine at a glance which parts come from outside vendors. Ask about Idea #302.

**Update outgoing bills by hand and still retain record of new data**

The sooner customers get billed, the sooner you get your cash. When purchases are made after bills are prepared, you usually have to wait for next billing cycle. This can tie up needed cash. Moore has a way to get these last-minute items added to statements after the computer run. The additional data is automatically included in your file copies. Ask about Idea #303.

**Cut detaching costs from \$5 per M to pennies**

Moore's Imprinter-Detacher can do in a few minutes what would take hours by hand. It detaches, removes margins, imprints, sorts. Lets you make better use of clerical help. Ask about it.

**If it's new, Moore knows about it. If you can use it, Moore will tell you**

Moore's 2600 representatives constantly hear about new ideas and weigh their usefulness to the people they call on. That's why it pays to keep in touch with your Moore man. He's a specialist in ideas that speed business transactions and keep the records straight. One Moore idea may be what you need.



**MOORE® BUSINESS FORMS, INC.**

Over 675 offices and plants, 2618 salesmen in North America



# Where the action is!

Compat's proprietary random access Magnetic Tape Memory Magazine makes our batch data terminals like none other.

*64,000 character storage; 0.5 sec. data retrieval time; high speed transmission with retransmission upon error detection; automatic printout; and format control.*

Add a wired logic system to our unique Tape Magazine and you have a batch terminal which outperforms terminals costing far more—COMPAT 88-13.

**OR—FOR UNMATCHED PERFORMANCE AT ANY PRICE—COMPAT 88-23** (only \$315/mo.) . . . Our Tape Memory Magazine plus our stored-program computer with special software.

*Complete editing capability: printout/overstrike/addition/deletion methods. Restricted field entry. 30 separate field designations, unlimited field titles. All English language commands. Any typist is an operator.*

For complete information on these outstanding terminals, write or call. Today.

**COMPAT**  **CORPORATION**

177 Cantlague Rock Road, Westbury, New York 11590  
(516) 822-1320 TWX 510-221-2821

# A MOST PROSAIC USE OF TIME-SHARING

by C. I. Keelan

In the extensive literature that I have read on time-sharing, I have never encountered mention of its use in the preparation of relatively short and simple management reports.

Each of Johns-Manville's plants prepares a series of reports that we call operating reports. Typically they show production data and the related standards, and indicate to management the efficiency of the plant's operations. In addition, similar reports are issued at division level, comparing several plants making the same product line. Most of these reports are issued monthly, and some contain year-to-date figures.

These reports have been prepared over the years by engineers and clerks, using desk calculators and typewriters.

In April of 1969 we leased a system from Data Network Corporation, a time-sharing center in New York City. The terminal was a Model 33 Teletypewriter with paper-tape reader/punch; at the other end of the line was a GE 420 computer. Using only the BASIC language, we wrote programs for six reports.

Typical of these reports is one showing the production efficiency of 22 pipe-making machines (the pipe is an asbestos-cement pipe used in water, sewerage, and irrigation systems and in industry—its trade name is TRANSITE). The 22 machines are identified by plant (seven blanketing the United States), and by the length of pipe they make (either 10 ft. or 13 ft.).

Monthly input shows for each machine:

Tons made  
Standard machine-hours for these tons  
Actual machine-hours for these tons  
Hours down (i.e., out of operation)

The program calculates:

Percentage of standard = standard hours/actual hours  
Production rate = tons made/actual hours  
Total hours = actual hours + down hours  
Percentage down = down hours/total hours  
Subtotals for 10-ft. and 13-ft. machines

The program contains a constant for the target production rate for each machine. A report for the current month is printed, followed by a year-to-date report. The year-to-date data is stored on disc during the month.

## cost

The cost of preparing this report on the time-sharing system is:

Hardware costs per monthly run

Storage @ 15¢ per 180 characters:	
Program — 3,504 characters	\$3.00
Year-to-date file — 1,182 characters	1.05
Connect charge @ \$9.00 per hour	.90
Cpu charge @ 4¢ per second	.39
I/o charge @ 3¢ per second	.32
	<hr/>
	\$5.66

Hardware cost per year	\$ 67.92
Annual cost of human effort	144.00
	<hr/>
TOTAL	\$211.92

The annual cost of preparing this report by the previous method was \$288.

The annual cost of preparing the six reports:

By the previous method	\$3,328.
By the time-sharing method <sup>1</sup>	2,400.
	<hr/>
SAVINGS	\$ 928.

<sup>1</sup> Included is a \$900 fixed cost for rental of the terminal.

Thus we achieve a saving with only six reports which, of course, do not begin to tax the capacity of the system. The investment in preparing the six programs was \$1,740; a saving of \$928 provides a very attractive rate of return on this investment. In addition, the reports now are issued several days earlier.

The significance of our experience lies in the fact that we were able to justify the cost of the time-sharing system with bread-and-butter savings (which have a solid appeal to approving authorities), thus making available to our production engineers a powerful tool for sophisticated engineering computations (as in statistical quality control).

## why not?

Is it possible that in our fascination with mathematics, we have overlooked the fact that a time-sharing terminal is a powerful general-purpose office machine?

Must the person at the terminal be an engineer, scientist, or mathematician? Why not a clerk—if the clerk's employer thereby saves money and gets reports out faster? ■

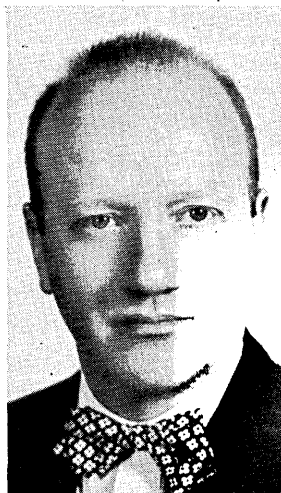

Mr. Keelan has been with the Johns-Manville Corp. since 1945 and is presently manager of Development Programming. He is a member of the All-AMA Planning Council and a frequent speaker at AMA seminars. He graduated from the University of Vermont.



# When you interview programmers, give our graduates a hard time. We did.

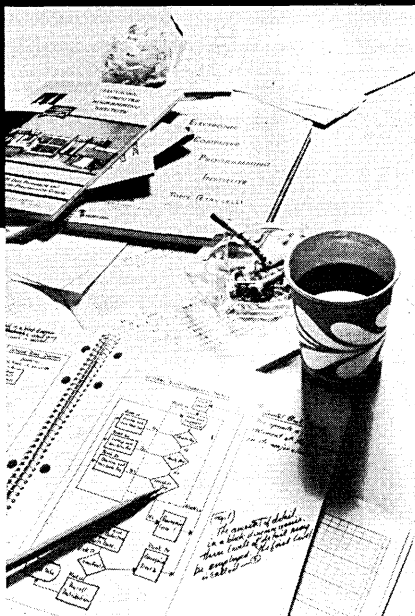

To begin with, we give them a hard time before they ever see the inside of our classrooms.

We make them take an hour-long written test. The test separates the people who have the aptitude from those who don't. Next, an interview separates the ones who can pass our course from those who can just pass our aptitude test.

And then the hard time really begins.

Our students have to grind their way through hundreds of hours of computer programming classes, sweat out hundreds of hours of homework, and pay over a thousand of their own hard-earned dollars for the privilege.

With that kind of investment at

stake, it's a safe bet that ECPI students spend their time looking at the blackboard, not out the window. But we give them many rugged exams during the course and a stiff three hour final exam

anyhow, just to make sure.

If you write us, we'll be glad to have a nearby ECPI training center send you a copy of that final exam.

You might find it interesting to try on some of the people you interview.

You could even try taking it yourself. You'll be surprised how much an ECPI student has to know to pass it and become an ECPI graduate.

But then, the way we look at it, the harder a time we give our graduates before you hire them, the easier a time they'll give you afterwards.

© 1969 Electronic Computer Programming Institute, Empire State Building, New York, N. Y.

 **ECPI ELECTRONIC COMPUTER PROGRAMMING INSTITUTE**

The  
toughest  
obstacle course  
in the business.

# How to be a rich and happy time share computer manager...

## *PICK UP a Technitrend Computer Port Selector*

Off the shelf NOW . . . Technitrend's new *high-speed switching AS-1000S Automatic Computer Port Selector*, that floats all connecting computer ports between in-calling terminals. What follows? — added profits . . . as the AS-1000S automatically keeps all your I/O ports fully loaded during peak demand — never an inactive port while customers are queuing! Ports need not be tied up by dedication to any incoming lines . . . but are available, when inactive, for use by local or distant customers.

The AS-1000S is easy to install, requires no adapters — just plug in line and port connectors . . . completely compatible with all time share computers. No changes in hardware or software . . . accommodates any size system up to 128 lines for 64 ports. Even has an optional, automatic digital answer back when all ports are busy.

*Write or phone for literature.*



**TECHNITREND, INC.**  
DATA COMMUNICATIONS SYSTEMS

7300 North Crescent Boulevard • Pennsauken, N.J. 08110 • (609) 665-4910

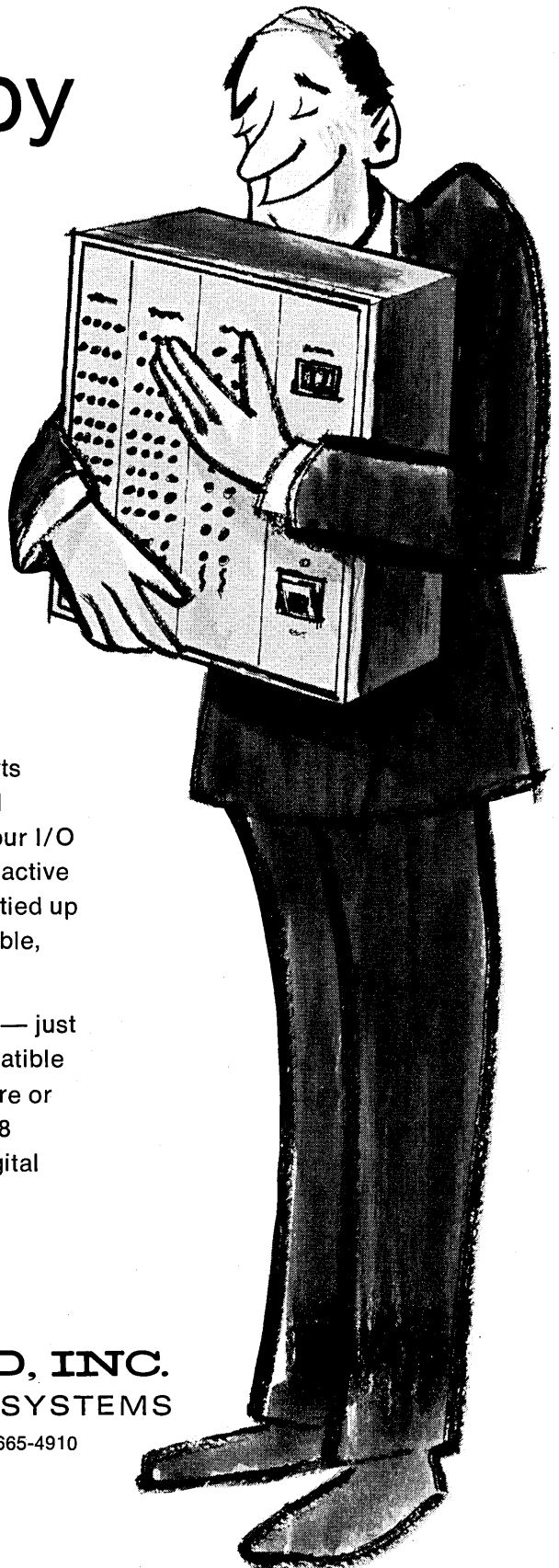

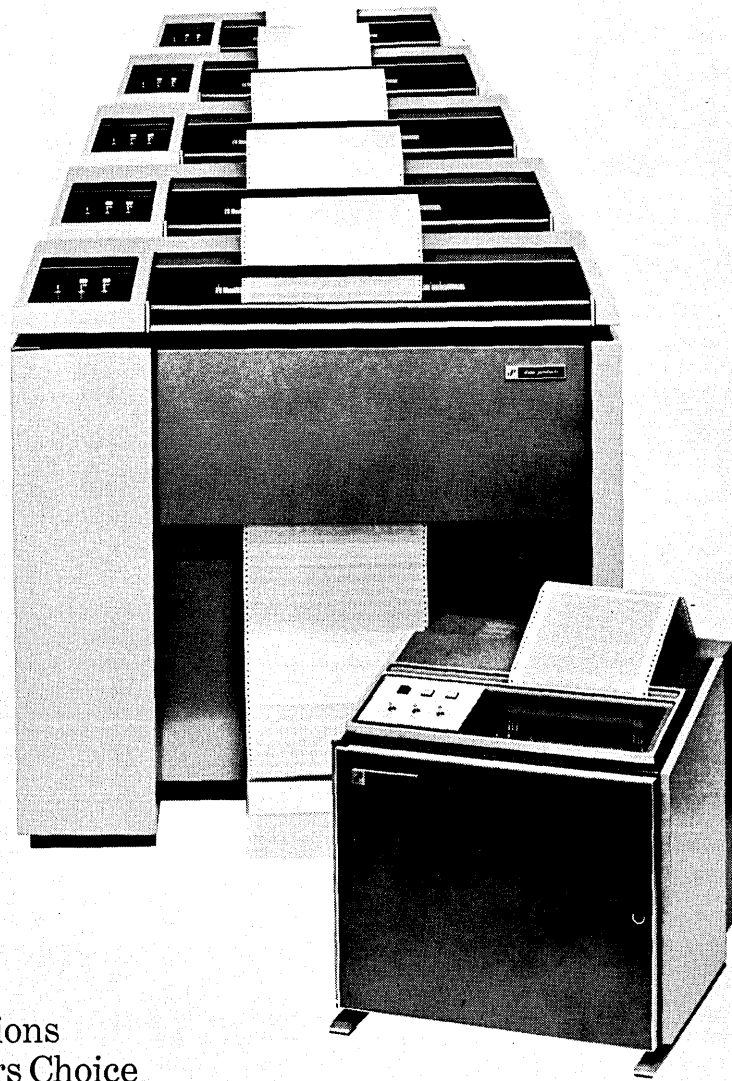

How a Choice of Options  
Makes a Line of Printers Choice

First offer the OEM a choice of line printing rates: 245 up through 1200, the highest speed on the market today. Then offer a choice of columns, 80 through 160. Add in interchangeability of spares. Include the unique Mark IV one-piece hammer for extra-crisp printing. You'll have a common-sense approach to a complete line of printers. Family planning you might call it. All that's needed now is the technology, the proprietary components and, of course, Data Products' experience. You've become first choice. (End-users also get a choice through our Systems Division which engineers fully-interfaced systems). Call Bob Englert (213) 981-9600.

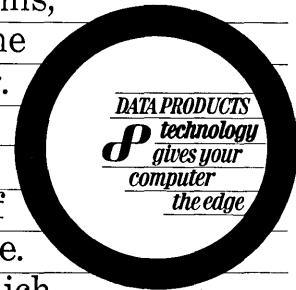

**DATA PRODUCTS**

*OEM marketing* 16055 Ventura Blvd., Suite 419, Encino, Calif. 91316

Los Angeles 213/981-9600 Minneapolis 612/927-8747 Dallas 214/239-9641 Acton, Mass. 617/263-3961 Bethesda, Md. 301/652-8120  
Melbourne, Fla. 305/723-0720 Chicago 312/325-6630 Amsterdam, The Netherlands 020/156-297 London, England 01-579-3116  
Cherry Hill, N.J. 609/667-7555

# AMA UNRAVELS UNBUNDLING

The American Management Association once again proved its ability to conduct first-class seminars in data processing management with a two-and-a-half-day session on unbundling. Held in New York in December, the conference was billed as "Unbundling Computer Support Services: Effects on Your Systems Costs Strategy." The speakers represented a cross section of uninhibited edp industry opinion.

The conference began with an address by co-chairman Roy N. Freed, who spoke on the "Challenge of Separate Pricing" and emphasized the importance of being able to deal with unbundled prices by predicting that all mainframe manufacturers will

light of present developments. Prominent among Forest's examples of pioneering unbundling efforts was the original CDC marketing approach of selling sophisticated hardware at a low price by providing little in the way of software. This required users who were either very sophisticated themselves or were unaware of how much effort software development would require. And that technique did not last long after CDC's inception in 1957.

Although most of the conference was devoted to predictions of what unbundling will bring, perhaps the most significant talk was delivered by Arthur C. Nessi, manager of the computer planning and control department at Ford Motor Co. Under the title "Developing a Corporate Cost

IBM systems engineers on hand—particularly those who have been working on continuing projects. Starting in mid-year, however, SE requirements will be put out for competitive bid. The firm has developed worksheets for its divisional dp managers on SE, field engineer, and program product requirements, and presumably the 1969 utilization will set a ceiling for 1970, i.e., the number of SE man-days in '69 should be greater than what will be contracted for in '70 because of the changed nature of pricing.

Each operational facility at Ford is allocating a token amount of budget dollars to both SE and FE services to avoid delay in obtaining them. If costs become appreciable, the company will review.



eventually be forced to separate prices, because the government will insist upon it. He said that user firms have been very careless in drafting contracts concerning purchase and use of edp equipment, and that unbundling gives greater impetus to improvement in this area.

Next came a "History of the Computer Pricing Strategy" by Robert B. Forest, editor of DATAMATION. He cited early examples of unbundling which went largely unnoticed in their time, but have new significance in the

Strategy in an Unbundled Environment," Nessi illustrated the advantages of a firm with a lot of muscle (\$15-20 million/year rentals to IBM), depth in dp management, and a centralized group to handle unbundling procedures. He noted that, despite Ford having signed the IBM agreement, no company can make firm commitments for services for anything but the near future. No one really knows exactly how much of anything he will need. Ford, at least for the first six months of this year, must keep some

## problems of program products

Program products are a big question mark at Ford. Much of the software Ford uses is pre-announcement programming, and is therefore free. The future depends on the cost of PP's and on how fast IBM moves in developing special packages to be competitive. The user should also be aware that a change in the operating system which could make compilers and application programs obsolete would present an intolerable situation under separate pricing. It is unlikely, of course, that IBM will do this.

Ford can afford in-house education and has developed a syllabus that has been in use for two years. The number of courses is now being doubled. Rather than centrally incurring educational costs, each man is being charged \$20/day.

But where Ford is really applying its muscle is in its payment procedures. The accounting department will not pay any bill unless it receives notice of receipt from the responsible dp manager, and the managers will not send it unless the machine or the program product is operating. In other words, if it doesn't work, it hasn't been received.

And if this isn't enough to put IBM in its place, Nessi predicts IBM will find *itself* in trouble from unbundling, in the area of field engineering billing:

# data set plotter

compatible  
with 2,000 or 2,400  
baud RS232B and  
Bell System  
serial data sets

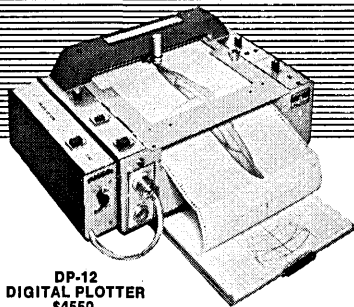

DP-12  
DIGITAL PLOTTER  
\$4550.

The DP-12's capability of operating with a 2,000 or 2,400 baud data set allows those users with communicative capability in their computer a simple low cost method of interfacing the computer and the digital incremental plotter.

#### TYPICAL APPLICATIONS

- Critical path drawings
- Logic diagrams
- Business form layouts
- Production of military manuals
- Isometric piping drawings
- Comparative financial analysis
- Architectural drawings
- Weather maps

Maximum incremental speed in steps per second	300
Incremental step size	.010" .005" .25mm .1mm
Maximum plot size Y Axis (pen) X Axis (paper)	11" 144'

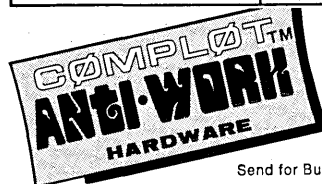

Send for Bulletin  
No. 170-DP-12

houston  
instrument

DIVISION OF BAUSCH & LOMB

4950 TERMINAL AVENUE,  
BELLAIRE, TEXAS 77401  
(713) 667-7403 CABLE HOINCO

houston  
instrument

European Office

Hardstrasse 235, 8005 Zurich, Switzerland  
(051) 44 19 70

## AMA UNRAVELS . . .

The Gray Fortress will be "hysterical" in trying to formulate billing procedures. Previously, he had commented that IBM is a notoriously bad book-keeper and the administrative and accounting problems created by unbundling will be huge for branch managers.

Continuing in the vein of immediate action, Dr. E. S. Savas outlined how "The City of New York Responds to the Unbundled Environment." The city has been using \$1-2 million in formerly "free" IBM services annually, but will not continue to do so, as this would represent a 5-10% increase in over-all edp costs. No proprietary software packages are used, and all hardware is purchased. Thus, faced with the additional cost of separately priced software and services, and no benefit from the new 3% price reduction, New York City is considering a suit against IBM.

### the irs speaks

A panel session on "Taxation of Software: Implications and Costs" was handled by attorney Robert P. Bigelow and Internal Revenue Service officials Nicholas Ange and Edwin A. Kelleher. Bigelow noted that under the IRS procedures for software costs released in October, the treatment of unbundled software as an intangible asset results in less of a tax break than if software is obtained under license or is included in the price of hardware. If obtained with hardware, it is "tangible" and as such is eligible for such tax advantages as investment credit and possibly advantageous depreciation techniques, neither of which is available for intangible assets.

The account given by the IRS men on the new regulations was somewhat confusing and there was sufficient hesitation on their part to show what many have suspected: the IRS, beyond the guidelines set, is not yet learned enough about software.

Several interesting points were brought out. For licensed program products, if the amount paid over the period of license equals or exceeds the purchase price, the IRS may rule that a sale has been made. And "huge installation fees" will probably have to be amortized. In Ange's opinion, the cost of preparing data for a data base will have to be amortized. Notably, if a user has previously been forced by local IRS agents to abandon an accounting technique which is now permitted, he may submit a claim for any resulting tax loss. Kelleher thought the IRS would be receptive to these claims.

Prior to the October announcement, some IRS offices had independently ruled that all software must be capitalized, rather than written off as R&D, for example.

Stanton Ericson, a dp manager for Sundstrand Corp., Rockford, Ill., said that many dp managers he had spoken to say that IBM SE's, during the bundled era, were sent to their installations for training, and were of little help: SE's who were no longer novices never returned. He then recounted that his IBM salesman asked if an SE trainee could spend a week in Ericson's data recording section in order to write a proposal on replacement of MDS equipment with IBM 050's. The salesman glibly acknowledged that it shouldn't take that long to prepare a proposal, but the trainee needed on-the-job experience. Ericson replied that Sundstrand Corp. too was unbundling and, since the training would be on peripherals, the fee to IBM would only be \$22/hour. This drew a good round of laughter from the attendees.

Ericson also suggested that most users have underestimated the capabilities of their own personnel—as well as their hardware and software. And in many cases where dp managers believe IBM SE's have been of little help, they may be unaware of assistance given their personnel who did not subsequently credit the SE's.

The most fascinating talk at the conference was delivered by cochairman Jerome B. Wiener, who is presently president of both Mandate Systems, Inc., a software house, and brand-new OnLine Computer Corp., a potential hardware-maker. Wiener said that for the past two years hardware has been cheaper than software, and LSI is going to make it still cheaper. Computers as small as wrist watches will be developed, prices will plummet, and small, presently inconsequential firms will advance new technologies which will revolutionize hardware. And if you don't believe him, he says his past predictions on time-sharing came true, he has over 20 years' experience divided about equally between hardware and software, and Mrs. Wiener has two LSI patents which enable MOS to operate at bi-polar speeds. And if any young male employees are looking for a gainful match, he even has an unmarried daughter.

Continuing in the hardware arena, Paul T. Clisura, vp of Comress, Inc., spoke on "The New Environment and Its Effects on Hardware Selection." He noted that in recent years the government seemed to think it would save money if IBM unbundled, and competitors believed unbundling would somehow lessen IBM's advantage or at least augment their own. But now

price reductions can only be thought of as a long range possibility—today's insignificant reduction may become significant tomorrow—and we should watch for economies in the fourth generation. To avoid becoming victims of oppressive pricing, user firms should get multiple sources of supply now, and more common users with common problems should form associations. Clisura noted that in the area of SE unbundling Compress had received 10 requests in the previous week for bids to provide SE's. He also said that unbundling makes IBM the number one software house, and IBM will now provide stability for the software industry as it has on the hardware side. This may cause the demise of smaller software firms. But the future is bright for users, with cheaper hardware and better software on the horizon.

Speaking of the "Effects of Unbundling on the Software Industry," vp Robert Kassel of Computer Sciences Corp. predicted that unbundling will result in software industry definitions becoming blurred, with common expressions like "software house" and "facilities management" disappearing. Also, "horrifying cost increases" of maybe 15-25% per annum will be levied on users, causing a slowdown in the increase and upgrading of installations, although there will be no decline in dollars spent. The user should eventually benefit from unbundling, however; after all, "prices would have gone up anyway."

Joan Van Horn, president of vp Systems Corp., spoke on "The Unbundled Environment and the Data Processing Service Center." She noted that service bureaus generally use the manufacturer's software as a "substantial base" for their activities. A problem likely to be faced by service bureaus, as well as other users, is that of back-up for software packages; with software priced per cpu, how can back-up be provided on a second machine without paying twice for a program which is only required for use on one machine at a time? Further, the additional cost of software in general is likely to cause "only the large time-sharing installation with a substantial customer base" to be able to provide the same sort of services that are now available through bundled software.

A plug for the leasing industry came—not unexpectedly—from Paul W. Williams, Jr., president of Boothe Computer Corp. He shrugged off prophets of doom for leasing, saying that unbundling will actually help leasing, by eliminating the "second user" stigma. "Now *everybody* is a second user!"

Now what computer industry organization will come forward to challenge this latest AMA invasion?

—F. BARRY NELSON

# RFL Builds Data Sets to meet every need

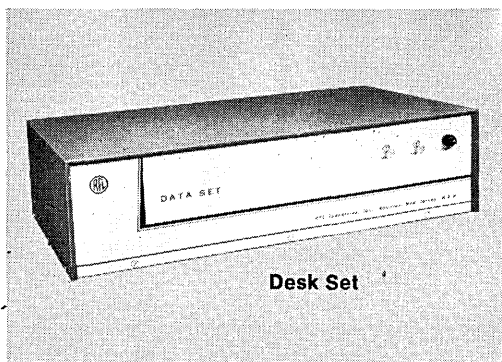

Desk Set

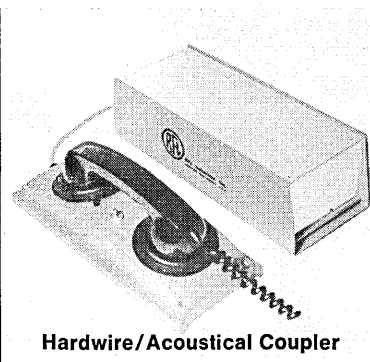

Hardwire/Acoustical Coupler

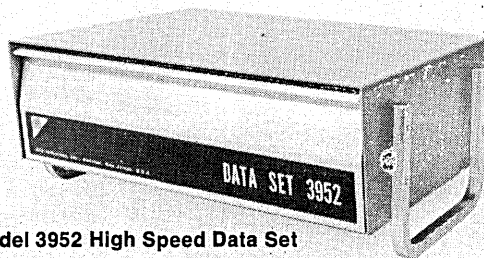

Model 3952 High Speed Data Set

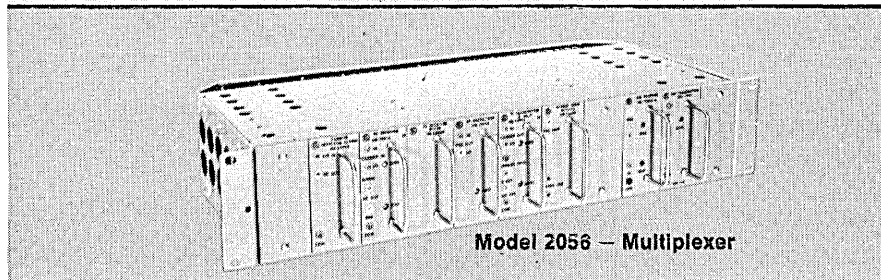

Model 2056 — Multiplexer

No matter what your data communication needs, look to RFL\* for the ultimate in dependable high-speed data communication equipment. RFL Data Sets handle computer, telegraph and telemeter data in combination or on an individual basis. The Model 2056 series provides the latest in transistorized multiplexing equipment — permitting the use of up to 23 channels over a single circuit, and RFL's "Plug-in" interchangeability feature gives you a choice of data speeds up to 2400 bits per second.

Rack mounting or desk type models are available . . . of course all are Bell compatible.

RFL offers an outright purchase or rental plan . . . so if you have requirements for data communications equipment, be sure to check RFL . . . we make a set to fit your needs. We've been building quality data sets for over 12 years . . . with prompt delivery.

Write or phone today for full details.



**RFL Industries, Inc.**

Communications Div. • Boonton, N.J. 07005

TEL. 201-334-3100/TWX: 710-987-8352/CABLE RADAIRCO, N.J.

CIRCLE 168 ON READER CARD



# The Potter Tape Drive. It's a lot more than less expensive.

The savings of up to 30% on purchase or rental are only part of the story. Potter Tape Drives are completely interchangeable on IBM 360, 1400 and 7000 Systems. There's no need for re-programming. Reel-to-reel threading and automatic loading save your operators' time. Potter's famous single capstan, vacuum column design, with read/write head that retracts during rewind, gives you substantially longer tape life and improved data reliability.

There are thousands of these Potter drives in use on IBM systems throughout the country—proving on a daily basis their reliability and economy. You, too, can get a lot more for a lot less—now! These outstanding units are available. We'd like to tell you more—call today. Potter Instrument Company, Inc., East Bethpage Road, Plainview, N. Y. 11803—Tel. 516-694-9000

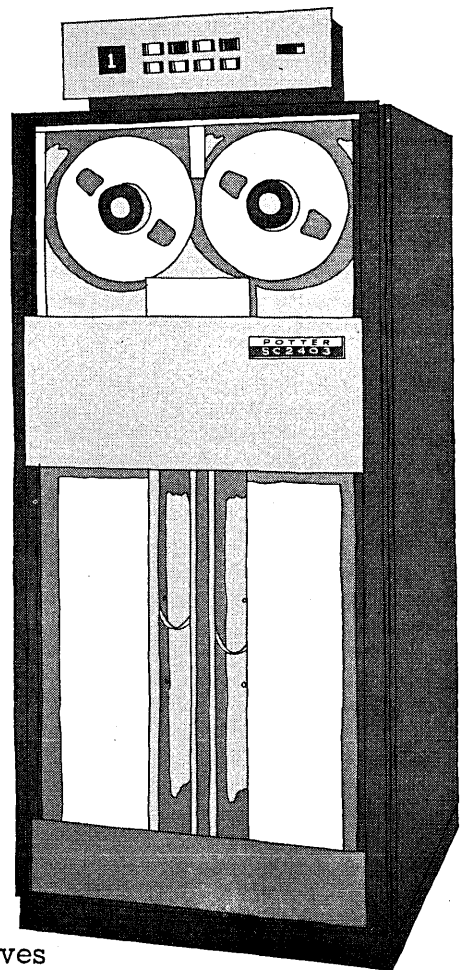

 **POTTER**  
INSTRUMENT CO., INC.

# A PLOT IS WORTH 1000 NUMBERS

## MOVE UP TO GRAPHICS!

Typagraph your data instead of printing hard to comprehend tables.

Typagraphing gives you hard copy plots *and* text on the same page. No separate Teletype!

Get fine resolution, fast plotting speed, quiet operation and free software. No changes are needed in your present computing programs. Send for our sample plots in your field.

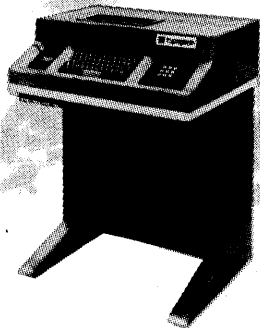

 **typagraph** <sup>tm</sup>

typagraph corporation • 7525 convoy court  
san diego, california 92111 • (714) 279-5899

CIRCLE 133 ON READER CARD

# RAPID SYN

"VANGARD SYSTEM"  
STEPPER & DRIVER  
COMBINATION

**\$9800**

IMMEDIATE DELIVERY  
ONE TO A CUSTOMER

## STEPPER MODEL 23H-502A

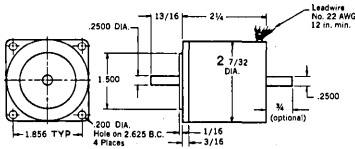

Step Angle 1.8° step  
Resistance/Phase 20 Ohms  
Stall Torque 60 oz in  
Running Torque 37 oz in  
Bi-directional Response 500 PPS  
Rated input 28 VDC

## DRIVER MODEL M43010

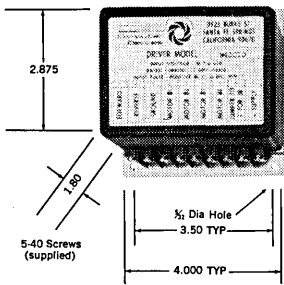

Input Voltage 28 VDC ± 6 VDC  
Input pulse 4 volts positive  
Current capacity 6 amps  
Bi-directional switching capacity 10,000 PPS

## STEPPER DRIVER

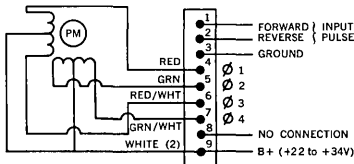

Vanguard system is offered to introduce the system designer to outstanding quality & performance of Rapid-Syn steppers. Computer Devices of Calif. mfr. a complete line of steppers in sizes 8, 11, 15, 18, 20, 23, & 32 and step angles of 1.8°, 45° & 90°. For complete catalog, write to Marketing Mgr.;

Computer Devices Corp. of California  
11925 Burke Street, Santa Fe Springs,  
Calif. 90670 • (213) 698-2595 - 723-6593

# COMPUTER MANAGEMENT 69

personnel, privacy, predictions

"Americans don't go for a walk on the moon, they take extravehicular activity," said England's Lord Halsbury, dinner speaker at Computer Management 69 and chairman of the British Computer Society.

Leaping lightly from the perils of the technical-jargon barrier to the security bugaboo, Lord Halsbury quoted Grace Hopper's observation that security systems are proliferating all over the U.S., and not one of them is immune to a bright young man with the time to try to beat it.

The House of Lords was already concerned about how far people's lives were going to be ruled by computers and numbers. In an early-December discussion there, one noble lord asked who would have access to a tape with, for instance, everybody's health history on it. The reassuring answer came from a minor official, who stoutly maintained that security would be assured because "those without authority will not be given access to privileged information."

Pointing up a respect for the individual's privacy that is perhaps uniquely British, Lord Halsbury harked back to the early 40's when rationing began in the U.K. The bill that set up the rationing numbers specifically stated that they were never to be used for any other purpose.

"If computers are being thrust down our necks, I don't think that will make a better society, even if it gives us better health profile data," he continued. "We have to be on our toes in thinking out computer interfaces with society. The computer as a social machine can be very cruel. If you're up for a job and have a 30-year-old conviction for felony drunk driving (or perhaps a generation hence it may be possession of marijuana) would this be forgotten, as by God, or remembered, as by an impersonal machine?"

Computer Management 69, sponsored by the administrative data processing group of IFIP, played to over 130 no-nonsense dp managers from England and the continent during early December in Manchester, England.

Although there were no U.S. delegates, the focus on American management techniques and technology was clear. The 25 speakers included professors Malcolm Gotterer (Penn

State), Malcolm Jones (MIT), Marvin Wofsey (George Washington University), and Ashford Stalnaker (Georgia Tech). In addition, Paul Dixon spoke for Massey-Ferguson/Canada, R. H. Kay represented IBM/San Jose, and Dick Brandon keynoted the gathering.

Professor Gotterer opened the proceedings by considering profitability—an undercurrent for the entire three-day meeting. He felt that the key to computer profitability is to make sure the computer manager has the tools and training and power to establish policy as well as carry it out. He set an-



other conference theme by calling for more management education along these lines, saying: "Rarely does the computer executive understand his role vis-a-vis the organization. Too often he's unaware of his relationships unless they're technical relationships."

Professor Jones, who is assistant director of Project MAC, talked about the management of large-scale computer systems, while Professor Wofsey considered the management of large-scale programming projects. From separate vantage points, they converged on the importance of thorough software specifications to the success or failure of a development project. Though there are as many flavors of specs as there are individuals to create them, and the professors thus diverged in their lists of what the best-dressed specifications are wearing this year, both underscored the need for a "blueprint" that grows and changes as a project develops.

Professor Stalnaker added still another profitability sidelight: he referenced a study by Bairdain, who infil-

trated several groups of programmers and randomly sampled their activities for six months. He found them actively working (in this he counted all activity in which they were awake and at their desks) a full 14% of the time.

Professor Jones sharply recommended that in-house computer departments should charge for all computer resources used, not just the one-third that is hardware in most installations, mentioning the natural resolution of priority squabbles that comes with "economic" sorting. He also predicted swelling tides of software packages, facilities management, and hardware maintenance that will make computer management a new game.

#### on-line projects

In Professor Wofsey's view, new software systems with real-time on-line capabilities permit output from one program to be input to another without human intervention. To implement projects on this scale, he suggests a project manager approach, with the leader of each four or five-man team having total P&L responsibility for his portion of the program, including maintenance, scheduling, costs and handling interfaces with other groups.

Because of the "Peter Principle" (organizations are managed by incompetents who stay there until they retire, get transferred, or die), Wofsey thinks leaders should be set up as "acting" project managers, so that going back need not be such an admission of failure. He also proposed a custom of long standing at SDC—that some kind of high-status "senior scientist" type of title be established for graceful retreat for nonleaders after they try.

A user's viewpoint on running large systems came from Philips' A. M. Steenhuis, who mentioned that spending the additional money to hire highly qualified operators was paying off at his company's 360/50 center in throughput that can be up to four or five times as high as the average with less capable operators.

#### panel predictions

Taking up the cudgels for British computers in a final-day panel that tied the past to the future, ICL's Peter Hall pointed out that Manchester was the site of such pioneer hardware developments as the first use of paging or index registers. Hall also noted that the smallest computer in the IBM or ICL range today is more powerful than the world's biggest computer only 12 years ago. The original Atlas was built with 8K of storage—more than anyone could conceive of using in those days.

Professor Gotterer picked up the "good-old-days" theme to mention that

**T**rouble with this terminal is that it's almost a millisecond away from the computer.



**But, if you've got a millisecond to spare, look what it's plugged into ➡**



The

# CYBER

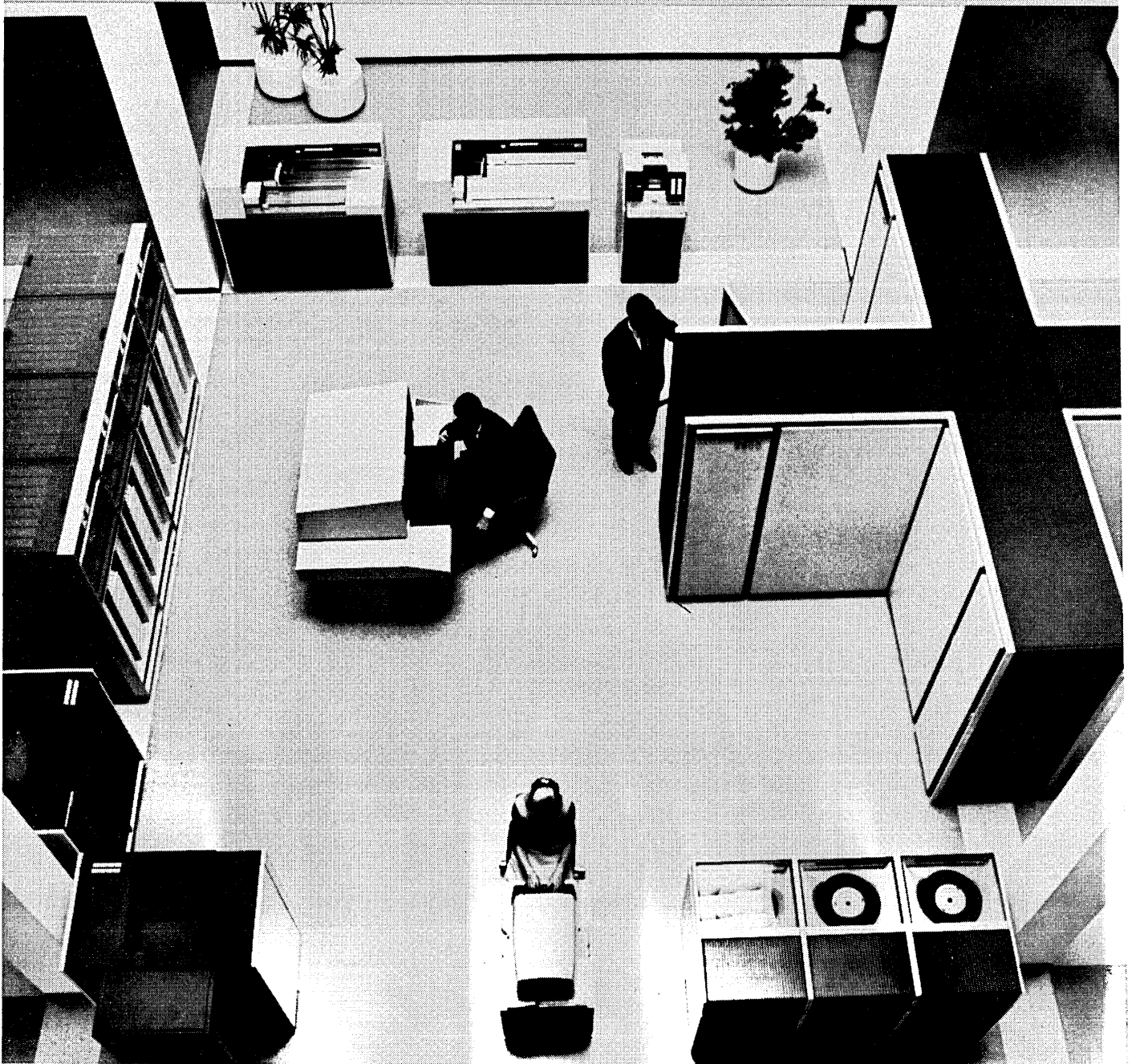

TM

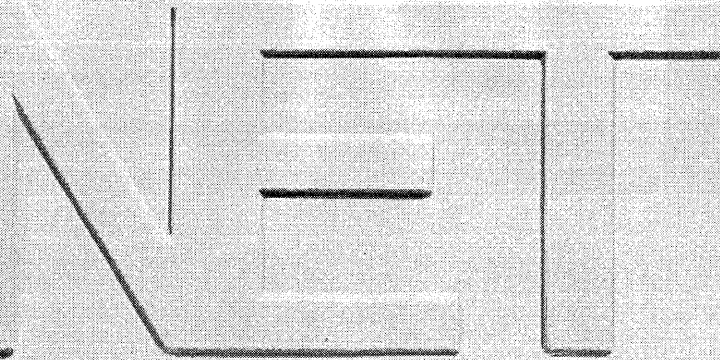

# system

**W**hen you send data from a CDC® terminal to a CDC Data Center downtown (or in the next town), it takes about 1/10,000ths of a second longer than if the mainframe of the computer were right in the same room with you. Now, supposing you could live with a milli-second time loss each day . . . why should you want to?

To start with, take a look at the computing power your terminal would be plugged into with Control Data's CYBERNET System. This is a network of computer centers located in 29 cities across the United States and worldwide. With CDC 6600 and 3300 computer systems, these centers provide a perfect combination of computing power and high capacity data processing capability for maximum efficiency.

To tap this power, you can select exactly the terminal and the peripherals you need. CDC's MARC™ Series of remote terminals range from the MARC-I, with its teletypewriter, to the MARC-V, with its own CDC 1700 computer combining remote with stand-alone data processing capability. Input/output capacities range from 10 to 6000 bytes-per-second.

Some of the things you *won't* have with CYBERNET usage include a large capital expenditure, large lease obligation, long-term commitment, limited backup capabilities, requirements for large space with air conditioning and raised flooring, and maintenance worries.

And, there's no minimum charge for computer time with the CYBERNET System. You pay just for the resources you use for the time you use them. That means the economy and efficiency of big machine processing even for smaller jobs. And big problems that would take hours or days on medium-sized computers are solved in seconds or minutes with the 6600 super-computer.

Software developed by CDC for the CYBERNET System now makes its remote terminals even more effective and efficient.

**SHADE** is a system that allows you to store all your files—financial, personnel, inventory—right at the Data Center. You can have the files on-line or stored and ready to go on-line at your call. Files are guarded by a special software system that gives you the only key. With your terminal you can update, revise, search,

printout your files simply and easily. All you have to transmit for any problem is new input, and any control information which may be required. There's also a recall system in case you make an error in changing your files.

**SHADOW** is a system that allows you to select any 3300 or 6600 computer in the CYBERNET System, or a combination of both, to solve your problem for optimum efficiency, economy and backup.

These are some of the advantages of the CYBERNET System. The more you think about them, the less you'll miss that big mainframe in your computer room.

To get complete information, call your nearest CDC Data Center, or contact us directly. We're only a milli-second away by telephone.



MARC V

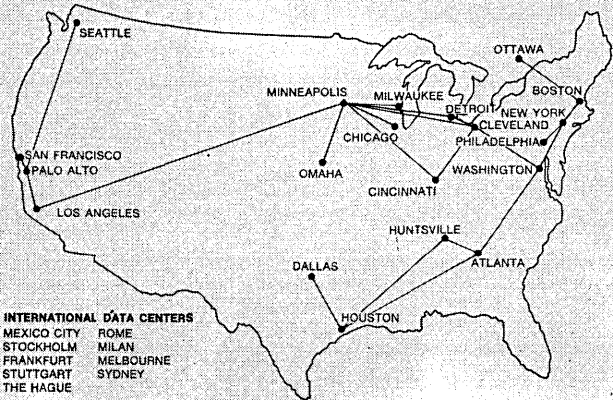

**INTERNATIONAL DATA CENTERS**  
 MEXICO CITY STOCKHOLM FRANKFURT STUTTGART THE HAGUE  
 ROME MILAN MELBOURNE SYDNEY

**CONTROL DATA**  
 CORPORATION

For further information, call or write:

**In the United States:**  
 Data Services Division  
 Dept. 221  
 Control Data Corporation  
 4550 West 77th Street  
 Minneapolis, Minnesota 55435  
 Phone: 612/920-8600, Ext. 5091

**In Europe:**  
 CDC Data Services, Dept. 221  
 Control Data GmbH  
 6 Frankfurt am Main 16  
 Niddastrasse 40  
 West Germany  
 Phone: 71-231



MARC II



**COMPUTER MANAGEMENT . . .**

software was free then, and people exchanged it freely. Then came the software package, which put constraints on configurations and how problems were solved. "Now," he said, "IBM's System/3 concept includes a program generator — you input local conditions and out pops your program. Thus you have a choice between handmade, readymade, or customized programs."

All these software developments, Gotterer believes, have forced the programmer farther and farther from the machine. New languages (mostly preprocessors like the new ones for COBOL) will simply widen the gulf between the programmer and the man who designs the computer.

Brian French, manager of administrative services for a major commercial user, injected a note of present concern into the pasts and futures flitting by. "Today I'm using more staff, effort and money to optimize my operations. Wouldn't it be better, perhaps, if we took all the optimizers and put them onto making cheaper and smaller computers. It might be better to have 30 smaller machines doing 30 jobs than one dirty great monster handling them all."

"The problem lies with overambitious users," retorted Gotterer. "Too many of you have read too much of what too many of us have written." Moderator Alan Butcher had the last say: "There's not much prestige right now in having a bunch of minis."

"We're expected to buy machines and software which haven't even proved themselves," French continued. "This is like building the first Concorde, filling it up with passengers, then sending it out to see whether it can fly or not."

**networks of networks**

Professor Jones' predictions concerned the service bureaus, particularly time-sharing bureaus. Forecasting more and more highly structured data banks, he said: "The independents who will be making money are those that develop their own proprietary data bases, maintain them, and guarantee them."

In the business realm, Jones sees a wealth of choices, between centralization on one big computer, or decentralized decision-making by remote use of a system. "I definitely see networks of machines coming, dissimilar machines, and even dissimilar languages, communicating with each other as they're beginning to do in the ARPA network even now."

"But who will manage these networks of networks, or systems of systems?", asks Hans Gassmann from OECD (Organization for Economic Cooperation and Development) in Paris.

Gassmann is concerned with the changes computers will bring to individual lives and to society. He points out that information could range from simple data processing (a single reservation transaction, for example) to information about information (a rudimentary MIS or data management system), finally to information about information (the kind of aggregation needed to create policy and do long-range planning).

"The direction is very clear," says Gassmann, "toward integration of existing systems — some with data banks—first between business and business, then between business and government, then perhaps between local, regional and central governments, until there's a system of systems at the national level. This would pose new sociological and economic questions, and perhaps bring about the re-evaluation of knowledge as power, as it becomes a base for both tactical and strategic decision-making."

Gassmann suggests that one approach to the awesome spectre of the information monopoly would be the separation of the information function from the executive function. Another may be to publicize what information is available. (In Scandinavia you can already look up your neighbor's tax status. You can in Los Angeles, too, for that matter, if he owns property.)

Just as Wofsey suggests a new post in industry—the data security officer—Gassmann thinks there might come to be a new class of "information lawyer," working under a code of ethics to run terminals and screen information requests.

"The computer will have impact in the realm of social innovation, too," says Gassmann. "Computers and cybernetics have done a great deal to bring the notion of feedback into general use. Now we will need feedforward—the knowledge of future problems, so we can take preventive actions, like the Helsinki talks, rather than getting conditioned to crisis as an everyday occurrence. Simulation may be the key to make the feedforward function widely acceptable to the public."  
—NANCY S. FOY

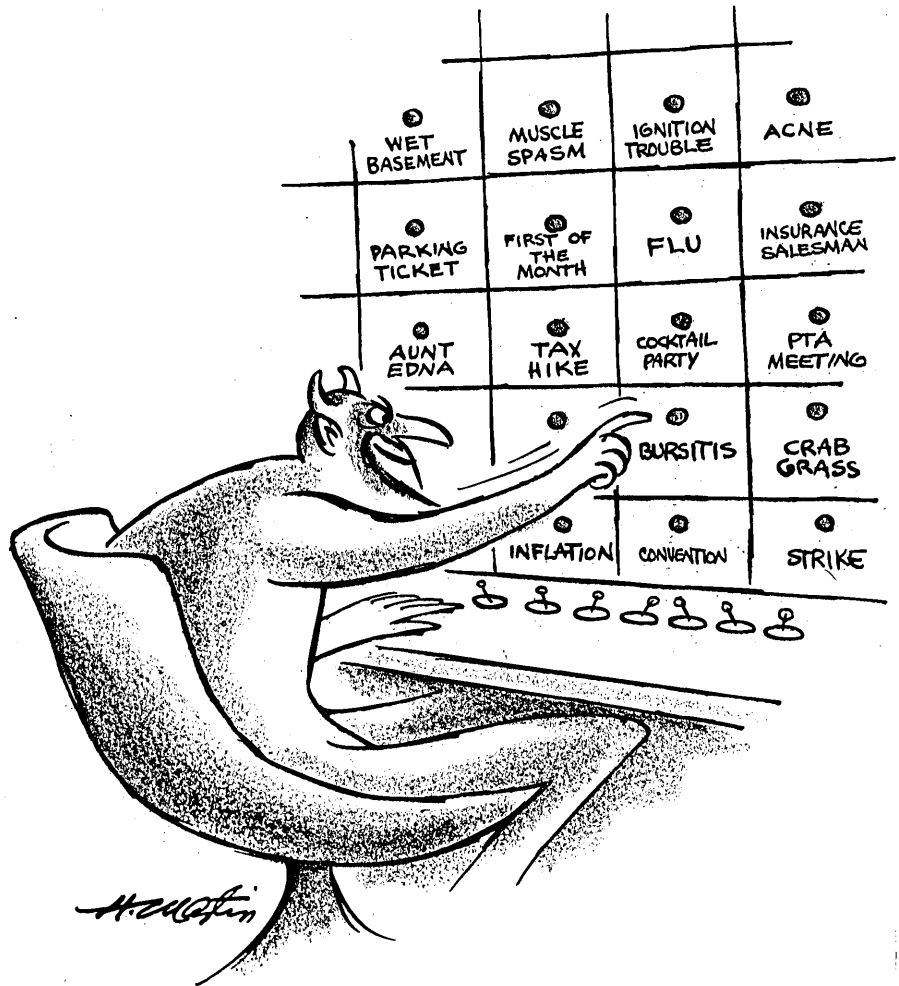

© DATAMATION ®

**DATAMATION**

# We have the right combination. The 6155 Dual-Processor.

Another combination of unique features from *The System Builders!* The 6155 Dual-Processor Computer System . . . offers complete big system concepts and capabilities for the medium-scale computer market. In spite of today's mounting costs, we offer this highly sophisticated dual system for the same price that often accompanies a single computer from our competitors.

The 16-bit 6155 provides fast concurrent processing, with the dual processor configuration yielding a high order of reliability for a relatively small investment. Users may perform batch oper-

ations of various kinds simultaneously with real-time functions. The shared disc/shared core capability of this system enables either processor to handle the critical application when necessary.

A considerable number of special features have been developed to enhance system dependability: power fail detection, parity checks on all input/output, dual power entry capability, and a watchdog timer which monitors all system operation. Allowing continuous processing of critical jobs are the Common XIO interface, enables either pro-

cessor to control any peripheral, and the Disc Exchange gives disc memory access to both processors. System recovery from a malfunction is automatic and instantaneous.

Sales or lease plan, employee-oriented equipment, complete training programs, and "total" customer service. Contact your nearest EMR Computer Sales Office or our National Sales Manager at 8001 Bloomington Freeway, Mpls., Minn. 55420, (612) 888-9581.

**EMR** COMPUTER  
*the system builders*

CIRCLE 144 ON READER CARD

EMR Division of Weston Instruments, Inc., A Schlumberger Company



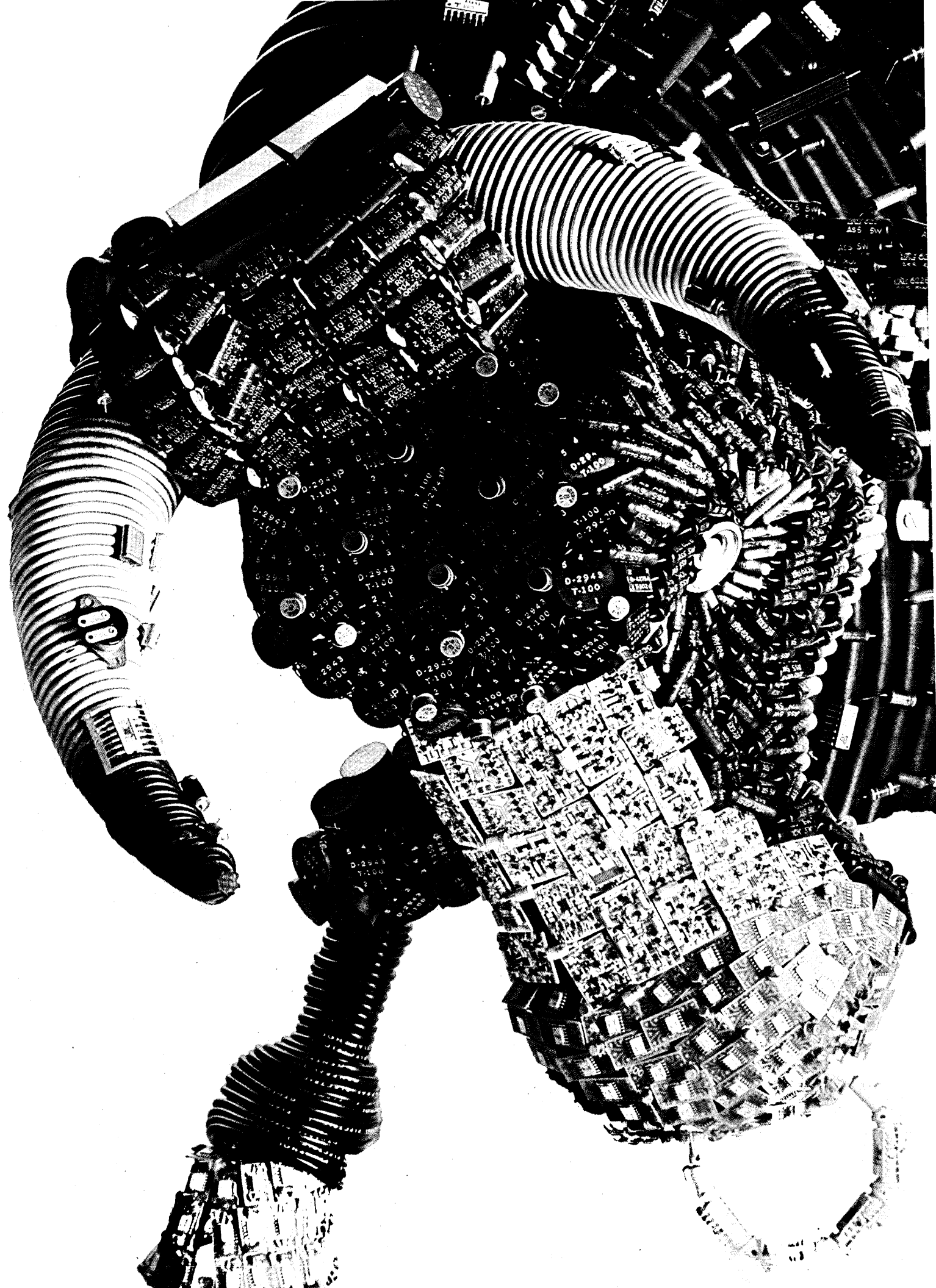

# Watch our medium-to-large computers attack your data processing costs.

## Take our new Model 3200

It performs like a 360/50, but it's priced to compete with the 360/40. It's been designed to handle the problems of operating system overhead and simultaneous disk transfers that are so important in a communications-oriented management information system.

It's fast, with an effective memory cycle time of 500 nanoseconds per character. And it can perform 16 input/output operations concurrently, with a maximum transfer rate of 1.5 million characters per second. So the 3200 can efficiently handle large direct access equipment providing extensive mass memory capability.

## And then there's the 4200

For even more capability, approaching that of a large-scale system, but at a substantial saving, consider Honeywell's Model 4200.

Our 4200 offers true simultaneous memory accessing by both the central processor and input/output devices. This, together with overlapping accesses and interleaving addresses across memory modules, means exceptional main memory utilization and increased throughput.

And its electrically alterable read-only memory prepares the system for firmware of the future.

It even boasts a maintenance processor which permits off-line diagnosis and repair of peripheral equipment, while the rest of the system continues to perform productive work.

## Advanced Operating Systems

Either our OS/200 or Mod 4 operating system can control the 3200 or 4200. OS/200 can execute up to eight operations at once, while Mod 4 can handle up to 20.

Both provide concurrent real-time and multiple batch-job processing. Mod 4 can also handle remote job entry and allocate the use of computer and peripheral resources. And OS/200 provides a powerful new capability for managing a central data base.

The 3200 and 4200 are powerful computers with a choice of advanced operating systems to match. Now add to that our bundled stance, and it's obvious why our competition is seeing red.

The Other Computer Company:  
**Honeywell**



From the original painting by Neil Boyle

## POSEIDON

Business data systems are still being designed and programmed to produce oceans of data, most of it useless to top management executives. We design and implement systems to produce information that management can *use* to improve operations.

We can do this because, in addition to the computer sciences, our professional staff represents more than 40 areas of knowledge: business, economics, the physical, life and

behavioral sciences, and most branches of engineering. We probably already have knowledge in your field; but we believe that only by knowing about *your* operation and *your* people can we design a business data system for you.

A brochure, *Computer Systems Design and Implementation*, describes our capability. For a complimentary copy write to Dr. Rue W. Harris, General Manager, Management Data Systems Division.



## PLANNING RESEARCH CORPORATION

Home office: 1100 Glendon Avenue, Los Angeles, California 90024

*An Equal Opportunity Employer. Candidates are invited to write to the Administrator for Professional Staffing.*

# INTERNATIONAL BUSINESS FORMS FORUM

a conference report

“Data Entry—the Dilemma of the 70’s” was the theme of the International Business Forms Industries’ second International Forum in Hollywood, Fla. The conference didn’t reduce the dilemma, although the Florida sun and sand may have provided a hiatus from it for some of the conferees. It did, however, give some indication of the extent of the dilemma: the attitudes and interests on standards and the multiplicity of data entry devices and techniques.

Rep. Jack Brooks (Dem., Texas) opened the forum with a call for a machine-independent data base language, specifically a standard access language that would permit the data to be self-defining and separate it from applications programs.

He went on to emphasize the need for study of the data entry situation, specifically optical character recognition. Rep. Brooks would like someone to find the applications best suited for ocr. This would resolve some of the problems of optical scanning, he believes, such as whether ocr fonts need be human readable. To this end he has recommended that the Bureau of the Budget undertake a study of the government’s use of ocr.

The options for data entry hardware were described by James H. Bauch, vice president, systems, Data Action Corp. Somewhat ruefully he noted that the keypunch was still the big input medium. Long use and low price have built a tremendous inertia about keypunching that won’t give way rapidly to key-to-tape and disc or ocr, he said. He also cited the “psychological degradation” experienced by some users when contemplating a shift to something outside the IBM spectrum as a drag to change in data entry media.

Change, he said, is also hampered by purchasing attitudes, i.e., the key-punch is a clerical tool so a supervisor can authorize purchase and installation, but key-to-tape and the like are edp devices and require a more involved acquisition ritual.

One of the minor dilemmas within the large one is whether terminals should have typewriter or keypunch keyboards. Robert Verb, director of graphic services, Management Con-



cepts, Inc., favors the typewriter. One strong reason is that there are more typists and typewriters than keypunchers and keypunches. He carried this argument to its logical end—source data preparation for optical scanning.

## costs and errors

Keypunching, he said, costs 94 cents per 1,000 words with a 2% to 4% error rate. Key-to-tape runs 77 cents per 1,000 words and the error rate is 1% to 3%. Copy preparation for a page reader costs 53 cents per 1,000 words and error rate declines to .003% to 1%.

Source data preparation costs 11 cents with .001% to .003% error. At present the data preparation economy is more than offset by the cost of the scanning equipment.

The picture is slowly changing. Jerry A. Ellis, system analyst, Mohawk Data Systems, a key-to-tape advocate, noted that data entry costs are rapidly increasing. Currently the annual bill is \$1.5 billion. Labor, mainly keypunching, costs \$1 billion, while \$300 million is for equipment rental and \$200 million goes for supplies.

The talks on standards covered the work being done on credit cards, ocr and the merits of ocr fonts A and B.

Card standardization at this point is concerned with placement of embossed numerics, bar codes, magnetic strips, circles and punched holes. C. T. Deere, vice president, marketing, Data Card Corp., illustrated this variety of options, pointing out that there were no conflicts in placement.

A talk on ocr standards was given by Dr. Joseph O. Harrison, chief of the office of information processing standards, National Bureau of Standards. He drew a parallel between the progress of edp use and standardization and the growth of the intercontinental railroad network. Standardization for the latter came about when the short-haul lines combined into a national rail system. Data processing would experience a similar situation now that people wanted to transfer data from one system to another.

Harrison detailed the standards that had been developed and accepted to date and said that programs to develop standards for evaluation of computer performance and application programs were soon to get under way. The advocate for standards, however,





# D-DAY EVERY DAY!

## D-DAY COMES OFTEN IN MODERN TRANSPORTATION

Only after months and months of intensive planning were the 4,000 transports, 800 warships and thousands of small craft assembled to transport the thousands of troops of the U.S. 1st Army and British 2nd Army on D-Day during World War II. In addition, 11,000 aircraft flew overhead to provide a protective umbrella for the Allied assault on Normandy.

Today, the complex transportation problems of major U.S. port cities

resemble D-Day every day. Cargo and people have to be transported by all modes of transportation including water, rail, highway and air, both inter-city and intra-city.

Government agencies have used C-E-I-R's operations research capability to develop port logistics simulators in order to measure and improve port effectiveness. One simulator was designed for evaluating port cargo throughputs, port service rates, port delays, port facilities and resource utilization. Although primarily designed for shipping problems, it is also capable of simulating aircraft and land movements, independently or in association with ships or water craft.

A broader based system called SITAP, Simulator for Transportation Analysis and Planning has recently been developed by C-E-I-R to provide a more effective analytical tool for both government and industry planners for solving critical transportation problems that have resulted from our country's unparalleled growth.

### PROBLEM SOLVING IS OUR BUSINESS

If you would like to know how your cargo or passenger transportation planning and scheduling or other problem solving can benefit from our Operations Research, write or phone us today:

CEIR Professional Services  
Division, 5272 River Road,  
Washington, D.C. 20016  
Phone: (301) 652-2268

To explore professional employment opportunities write C-E-I-R's Professional Staffing Department.

## BUSINESS FORMS FORUM . . .

does see areas where they are not needed. Despite the viewpoint of Jacob Rabinow, he questions the need of an ocr font standard. The government, he said, will probably not adopt the A font for ocr. He feels the increasing sophistication of ocr machines will make existing typewriter fonts acceptable.

Rabinow, vice president, Rabinow Laboratory, division of Control Data Corp., took exception to Harrison's questioning of font standards and a number of other things, among them the B font, championed by ECMA (European Computer Manufacturers Association) and its secretary general, Dara Hekimi. Two Rabinow points were: it's better to have a standard and change it than to have none at all; standardization and specialization are the routes to inexpensive and efficient ocr. Of the two scanning techniques widely used in this country—logic-directed recognition of specific characters or feature analysis—he prefers the former for most applications. CDC is using it to produce a \$5,000, 14-character set, 15-character-per-second reader for the U.S. Banknote Co. for reading stock certificates.

Rabinow said business should set its sights on single-line ocr devices with an under \$10,000 price and page readers for under \$30,000.

ECMA's Hekimi confined his remarks to the relative merits of the A and B fonts, primarily the latter.

The last day of the forum presented another rehash of communications and edp. Bernard Strassberg, chief of the common carrier bureau of the Federal Communications Commission, was the leading spokesman on the subject.

He indicated a liberal FCC policy toward new common carriers, noting that the communication demand is insatiable and communication systems might have to change to accommodate it. Strassberg said the three-year-old FCC computer and communication inquiry had done much to familiarize the commission with the field and had guided it in making the foreign attachment decision.

The next decisions for the commission, he indicated, are the questions of the extent to which the network signaling function can be incorporated into equipment by manufacturers (this is a sensitive area since the carriers use the signal for billing); unfair competition from the carriers in data processing services; and regulation or no regulation for message switching and data service combinations. —JOHN WESSLER

C-E-I-R  
Professional  
Services Division

**CONTROL DATA**  
CORPORATION

CIRCLE 114 ON READER CARD

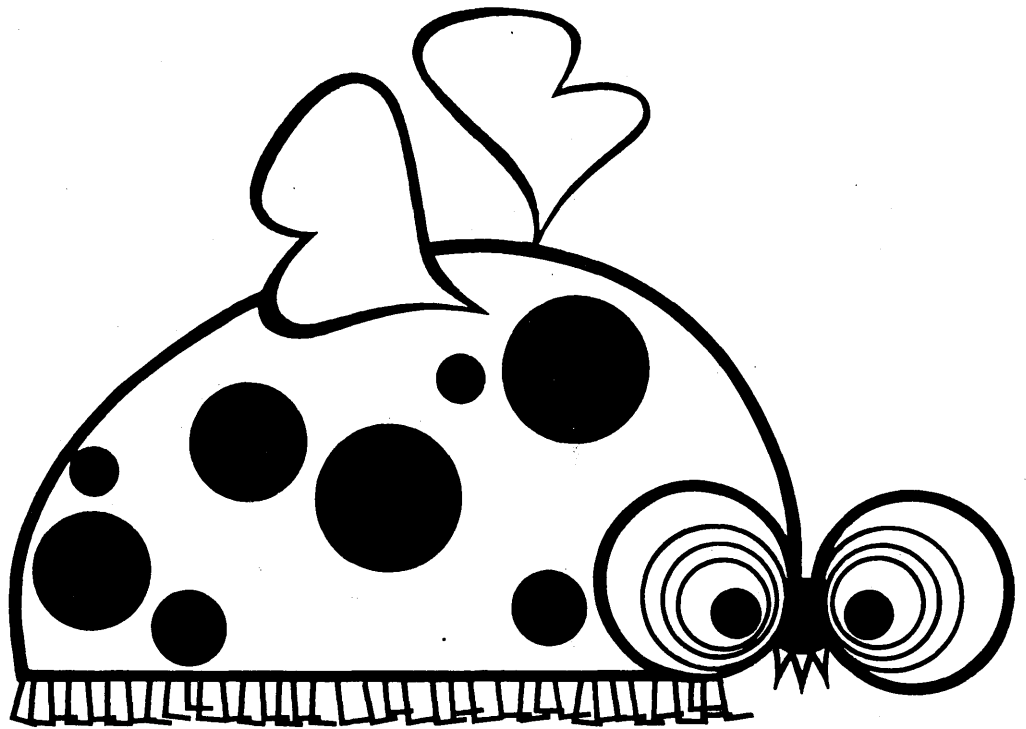
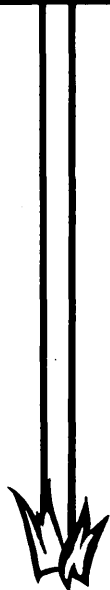

This is a specimen of the great speckled computer bug. It is normally found under the covers of many computers. We feel there's **NO WAY** for computer bugs to go but *out!* Computers should *give* service, not *require* it. Our computer is not yet on the market, but it soon will be — and without bugs. Since we plan to market it in OEM quantities in the \$1,000 price range, it's in everyone's best interest — ours as well as yours — to be sure that all the bugs are eliminated.

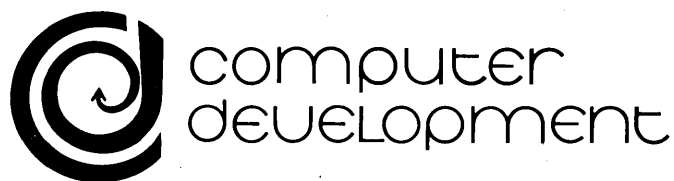

3001 South Daimler Street / Santa Ana, California 92705 / (714) 557-9720



# news scene

*an interpretive review  
of recent important  
developments in  
information processing*

## **USERS BALK AT SIGNING IBM'S DOTTED LINE TO ENTER NEW ERA**

Some soothsayers predict 1970 will be The Year of the Bloodbath. The reference is to Separate Pricing and The User. It's in its operational infancy at IBM right now, so no tally is in. No one's really sure exactly how much it will cost — 6-10% increase in total edp costs, 10-20% of hardware costs, are various estimates. It will vary from case to case, from small-scale to large-scale user, from the well-run installation to the installation that isn't managed at all.

But users do seem to have one common problem: the pieces of paper IBM is asking them to put their names to before they can receive services or programs. Pre-Jan. 1, there were estimates that only 25% of IBM's customers had signed the Systems Engineering Agreement and even fewer had signed for Program Products. The latter is in part due to the few for-fee program announcements to date, but it's safe to say no one is really happy with the detailed stipulations of either, even if they've signed. "Extremely one-sided, favoring the author," is the consensus. "Most of the concern I have heard expressed stems from an apparent effort by IBM to be protected from every imaginable type of law suit or to respond to those already in litigation," said Richard Davis, American Express, at a GUIDE meeting in Denver in November.

IBM has already changed the SE agreement once, and at writing some revisions were reportedly in the works for the Program Product license. For now, there is strong resistance to both the contracts. One large aerospace firm refused to sign the SE agreement, threatening that an SE better come when needed. Many have refused to sign because the combination of the contract and the "exorbitant" fee is "too much" and will develop in-house talent or go elsewhere. Others await changes in both contracts and some information on how IBM is operating in practice — whether it will be flexible in its charges or will nickel and

dime the user for everything.

Others have signed their agreements for good reason, such as, on-going projects which cannot be interrupted, and the need for a direct pipeline to IBM. But the industry must sadly read that one small user signed because "that IBM gal we have is the only one who knows where the paper is hidden."

Independent actions certainly have impact on IBM, but the most constructive effort is by the GUIDE user group, whose task force was supposed to have submitted resolutions on the policies and contracts to IBM by mid-January. (It was not public at writing.) There is no evidence, however, that SHARE will use its powerhouse of talent and influence to negotiate as a group.

Richard Davis, leader of the GUIDE task force, noted that the GUIDE attitude in this effort is not to pressure IBM with threats — no one was asked not to sign the agreement — but to arrive at some compromises that will leave both the user and IBM protected. The problem is, he noted, that the users and their organizations have never been faced with legal and business questions like this, and even if some of the stipulations in the contracts have been common practice, the user has never been legally bound to them by a document. Admittedly, the GUIDE action has not been rapid enough, but it hopes to be effective.

The following list of major objections was gleaned from discussions with Davis (his own opinions), Eagleston at First National City Bank, and several other industry and university IBM users who prefer not to be named.

### **systems engineering contract**

The revised contract, issued late October, solved some problems by providing a confidentiality clause. But the IBM-stated intent to "instruct" its personnel to keep the secrets is not enough; "IBM should take responsibil-

ity as a company, at least for the tenure of the SE at IBM."

The rights in data clause, revised to give the user exclusive ownership to all original materials produced by or with IBM, still "falls short." IBM still claims right to "ideas, concepts, know-how, or techniques relating to dp" if its personnel were involved in their development, and to produce any materials, regardless of their similarity to the customer's original materials. To some this is totally unacceptable. "What an IBMer even thinks while he's working for us, still belongs only to us."

Various advice: plan projects carefully and don't hire IBM for work on confidential dp ideas; "try to" obtain a special contract from IBM for such work stipulating protection for the user, paid royalties for any IBM product that results from the user's "ideas," etc. or other benefits from a joint development.

Limitation of liability. IBM agrees to be liable only for the amount of the contract. It has never been willing to accept consequential damages, a reason it has not fared well in the process control area. Some users won't sign, say they will request some SE services anyway, and will sue for damages if the situation occurs. American Express counsel is developing "some suggested modifications."

IBM will provide only a verbal or signed SE estimate for a project, and will not be held liable for its accuracy. Some want either a fixed-price or time & materials contract. Davis suggests an alternative: a signed service estimate for all projects and a requirement that an "amended estimate must be executed before the original can be exceeded." The current contract doesn't require an SE manager to advise the user of a potential override before the fact.

IBM retains the right to select which SE goes to a user. Eagleston noted that at First National, because of on-going telecommunications projects, their

contract stipulates the SE by name, and will for later projects stipulate qualifications only.

IBM's clause about changing SE rates with some notice is unacceptable to most users, as is the fact that the agreement is a blanket agreement for life, if desired. Preferable would be project contracts that terminate at the project's end and stipulate that the SE rate will stay the same for the life of the contract.

Terminating SE services with three-months' notice is unsettling, but an IBM letter to branch managers with the revised SE agreement lists only nonpayment of bills as cause for termination.

IBM doesn't guarantee immediate replacement of an SE when he is ill or quits, which is understandable, but should the user foot the bill for the replacement's "learning process" on the project?

### now listen

Advice: never let an SE have major responsibility on a task and arrange for in-house backup for him; review the replacement's "learning process" with the SE manager and if slow and costly, ask for time rebates; request payments begin for the SE "one month after shipment," as with program products.

Some suggest that additional SE duties not spelled out in the general agreement be stipulated. Others don't, assuming it is policy. Using the SE as an instructor at the hourly rate is one such duty.

[Note: We asked IBM if a leasing company, providing education courses to its users to help them defray those costs, could sign an agreement and get an SE as an instructor. At writing, it was unclear whether a leasing company that was not an actual user, only an owner, could obtain any SE services.]

### program product agreement

Before making this list, we should note that IBM has issued some no-fee licenses to users where IBM had made a commitment for a particular program prior to June 23 and had used that facility as a beta-test site (preliminary testing). It is unclear whether IBM will continue the beta-test practice with users.

The most objectionable clauses to program product licenses are the IBM-reserved right to terminate a program license with six-months' notice and the limitation of liability. IBM is expected to change the termination clause to no cancellation, except where there is patent or copyright infringement alleged. The "damage of a termination could be irreparable, say,

to a service bureau or a large aerospace firm with a contract to meet."

IBM limits its liability for a program about as it does with SE damages: "the charges paid by the customer for the particular licensed program or optional material involved or 12 months' charges for that licensed program or operational material whichever is less." This includes patent or copyright damages, except that IBM will pay court costs. No consequential damages can be levied either, says IBM. Some users won't live with this either. IBM is not expected to back down on consequential damages, but users are hoping it will assume full responsibility for patent and copyright infringement — not uncommon in license agreements in other industries, says lawyers.

IBM won no friends by charging a monthly program fee per cpu, even though this is not an uncommon practice. It will have costly effects on everyone, especially the multiprocessing operation, service bureaus using other SB's for backup, and universities and small users with very tight budgets.

### research hunt

The universities will be hurt in research and educational efforts by this arrangement, since it will not be able to justify the license for a valuable but seldom used product. One spokesman suggest that IBM come up with an alternative, such as a per-use fee. Other suggestions are an installation fee, quantity discounts (not likely unless the government can finally win that battle with IBM), provisions for short-term use of nonlicensed cpu's for overload situations, and provision for a multiple-cpu license (regardless of cost) to eliminate the paperwork and scheduling problems the one-cpu method causes.

Acceptance testing is not provided, although payment begins a month after shipment. What happens if the mail fails? Ford Motor Co. for one doesn't plan to pay for anything unless it's working.

No warranty. IBM says a product with service classification A or B will "conform to its published Program Product Specifications when shipped to the customer," but on the other hand it also says, it does not "represent or warrant" that design objectives (stated at announcement) or estimated availability dates will be met. Users are wondering how they can legitimately make a purchase, since the design objectives may differ drastically from the specifications when it's shipped. A minimal warranty at the least will be demanded.

The program service classifications run hand in hand in confusion with the Field Engineering software maintenance. Few users we talked to either understood what they would be billed for or were willing to try to articulate it. We asked IBM for a presentation given to users on how it would work, and were told that such presentations were tailored to the user and could take all day if discussed in full. In short then, for now, it is safe to say there will be questions on problem definition, on the determination of what is code altered by the user and what is pure code — and where a failure may lie, on the difference between an accurate manual and a badly written accurate manual, and on the difference of opinion between the in-house programmer and the Field Engineer re: whose fault was it?

The best advice for users is a monthly review of all billing with the FE and SE manager and extremely well-kept user records on his IBM personnel and tasks performed.

In short summary, IBM does have

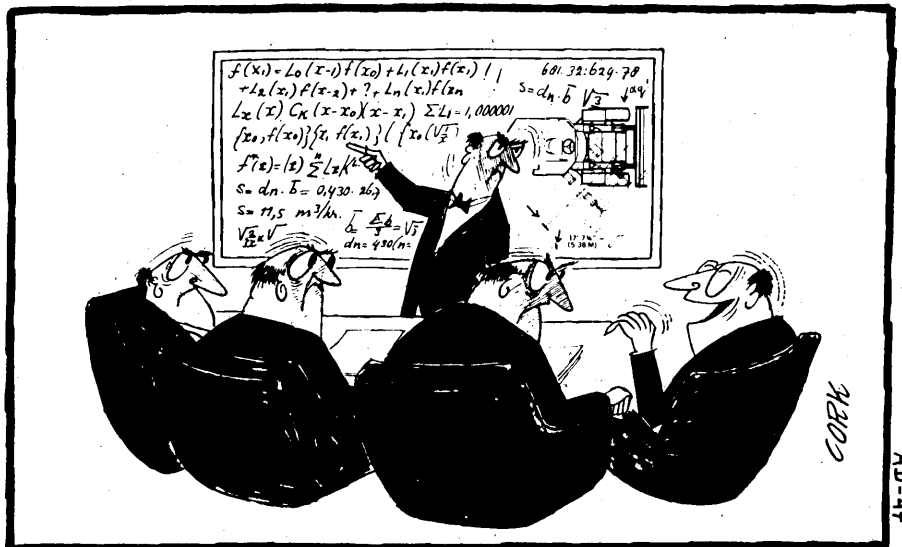

Immediate delivery!



## Over 800 in the field and more every day

In addition to its outstanding performance, the Datapoint 3300 is available *now*. We're proud of this expanding list of suppliers who are helping us place Datapoint 3300s in your hands *immediately*.

Ask your terminal supplier about immediate delivery of the Datapoint 3300 CRT terminal.

Canadian Engineering Surveys, Ltd., Edmonton, Alberta, Canada  
Consolidated Computer Services, Ltd., Toronto 1, Ontario, Canada  
Data Automation Co., Dallas, Texas  
Multiple Access General Computer Corp., Ltd., Don Mills 403,  
Ontario, Canada  
Sexton Data Products, Inc., Minneapolis, Minn.  
Tel-Tex, Inc., Pasadena, Texas  
Time-Sharing Terminals, Inc., Rockville, Md.  
Tymshare, Inc., Palo Alto, Calif.

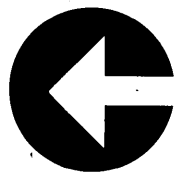

**Computer  
Terminal  
Corporation**

A TEXAS CORPORATION

CIRCLE 141 ON READER CARD

HOME OFFICE: 9725 Datapoint Drive, San Antonio, Texas 78229, (512) 696-4520

REGIONAL OFFICES: WESTERN — 3807 Wilshire Blvd., Los Angeles, Calif. 90005, (213) 380-2497 • MIDWESTERN — 7851 Metro Parkway, Minneapolis Minn. 55420, (612) 727-1344  
FEDERAL — 1815 N. Fort Myer Dr., Arlington, Va. 22204, (703) 524-6455 • EASTERN — One Bank St., Stamford, Conn. 06901, (203) 325-2244

many customers who have signed or will soon sign its agreements. It will provide some emergency service to nonsigners. It reportedly made two-thirds of a six-month \$30-million SE goal before Jan. 1. It is not making SE managers responsible for any quotas

## PRIVACY: THE BASIC QUESTIONS TO BE FACED ARE POLITICAL, NOT TECHNICAL

Prof. Alan F. Westin concisely described key issues involved in the public debate over individual privacy when he spoke last month at The Brookings Institution. He performed another valuable public service by suggesting some largely overlooked ways of protecting privacy. But, after asking whether government really needs more information — possibly the most important single question that can be raised in any discussion of privacy — he fudged.

Westin, professor of public law and government at Columbia, was the featured speaker at a seminar, one of a series on Computers, Communications, and the Public Interest being presented by the Washington, D.C., think tank with financial support from the Alfred P. Sloan Foundation and the American Federation of Information Processing Societies. Others appearing with Prof. Westin were David L. Bazelon, chief judge of the U. S. Court of Appeals for the Washington, D.C., circuit; Charles Schultze, former director of the Budget Bureau, and Ralph Nader, the well-known consumer crusader.

Westin's thesis was that the conflict between the state's need to know and individual freedom has been with us a long time. The computer, along with other socio-technological changes, has aggravated and intensified this conflict, but hasn't changed its character, which is essentially political rather than technical. The distinction is important, he suggested, because most recent effort to protect privacy has been directed at technical, rather than political, considerations. As he put it:

### matters of social policy

"Primarily, the focus of system administrators has been on devising hardware and software measures (to protect privacy) . . . These are expenditures of time and money in the right

until July, giving them time to work out some bugs and procedures. Indications are that IBM will bend its policies somewhat in practice; in some cases, we hear, the salesman will be permitted to pay for SE time for a user out of his commission points to protect a sale. But that doesn't make signing a hard, fast contract any easier for some users, and judging from the size of the ones who are screaming, IBM is paying attention to the cries for a change.

—ANGELINE PANTAGES

cause, and they deserve to be encouraged . . . But . . . the basic questions that need to be faced here are *political* not technical. They are matters of social policy to be worked out by balancing the values in civil liberties against those of efficiency and secrecy in government operations."

Westin began discussing possible approaches to the political side of the problem with the statement that "I do not see any value in trying to outlaw computerized information systems as noxious per se, though there may be some particular data systems that are too large, too intrusive, or too vulnerable to misuse at present for us to permit their initiation at this point in our technological and social development."

He then went on to suggest the drafting of model statutes and the development of ethical guidelines which would permit data to be disseminated without violating due process — e.g. the individual's right to defend himself against punitive action taken by the data recipient; the individual's right to protection against self-incrimination; and his right of appeal to a higher authority when an administrative agency controlling a data bank takes an action concerning the individual's file which he opposes.

### data bank auditing

"I think that a public review committee . . . should be created for annual audit of (each computerized data) system's general operations in terms of civil liberties," Westin added. "It could be made up of representatives from various legal, professional, and occupational groups, and should include some persons experienced in the particular field of policy of the data system.

"A final possibility . . . is an independent registry and rule-making commission on computerized data systems, a proposal that has been spon-

sored recently in the Canadian and English parliaments . . . Whenever a government agency decides to computerize its operations, it would have to register this intent with (the) commission, (which) would conduct hearings to examine the system design plan, the needs for confidentiality and disclosure in that field, and the proposed rules and procedures for insuring individual rights to privacy and due process. This would be like a licensing hearing, open to the public and to participation by interested groups." The commission would also "have power to conduct regular inspections and audits of systems under its jurisdiction," and would have to approve any substantial change in function or information processing capability.

### the time for decisions

Westin underlined these recommendations with a warning that "the computerized data systems already created are still in shakedown phases and have not yet passed beyond our effective power to install civil liberties safeguards, if we mean to," but "the first half of the '70's may well be the most important period in the next 15 years, because it is in this time period that computerized systems will begin to take more definitive shape, to integrate information in potentially very dangerous fashion, and to need clear public policy guidance for the creation of basic standards."

Ralph Nader, in his comments on the Westin paper, suggested that more time and effort should go into defining "privacy" — especially in deciding whether any data is inherently non-sensitive. Ex-BOB Director Schultze, who was in office during the great debate over the National Data Bank a few years ago, made it clear that he thought some kinds of data *are* non-sensitive — specifically data about group social and economic characteristics, the stuff of which census tabulations are made. Judge Bazelon emphasized that protection of already-stored data will mean little if adequate controls aren't exercised against incomplete, inaccurate, biased data gathering methods.

Possibly the most significant part of Prof. Westin's paper was his statement that: "What computer data systems offer government is a virtually irresistible temptation, in the absence of restraints, to unite Rational Government, Social Science, and Social Reform in a 'total information attack' on the pressing problems of our society. It is an article of faith by Rational Government that what we are missing in the policymaking process is better information." He then added, "Let me pass over . . . the question of whether





## All other mini-computers move over. CENTAUR is here.

Foto-Mem CENTAUR is the highest powered, lowest cost mini-computer.

It is easier to program, easier to interface and maintain. It is the fastest small computer in the industry. Programmers can debug test programs on the same machine without affecting the main line operation.

Eight programmable hardware registers include a 17-bit accumulator and a 16-bit index register. All simultaneously displayed on the front panel. CENTAUR is the only mini-computer with hardware multiply and divide as a standard feature. Deliveries from stock within 30 days.

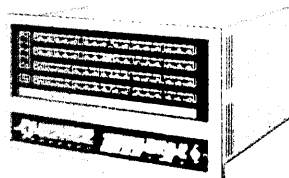

### Before you specify or buy, compare.\*

Computer with ASR-33	Price	Memory Size	Cycle Time	Add Time	Multiply Time
CENTAUR	\$8400	4K	.98	3.0	7.2(2) 87(3)
PDP 8L	\$8500	4K	1.5	3.20	360(1)
NOVA	\$9650	4K	2.6	5.90	334(1)
HP 2114	\$11,950	4K	2.0	4.00	187(1)
H 316	\$11,400	4K	1.6	3.20	256(1)

(1) Software (2) 8 bit x 8 bit = 16 bit (hardware)

(3) 16 bit x 16 bit = 32 bit (software)

**fom** 6 Strathmore Road  
Natick, Massachusetts 01760  
FOTO-MEM, INC. (617) 655-4600

\* Specifications are based upon latest data available.

... it is the shortage of information or the failures of political skills that most inhibit good decision making here. I find the answers to these inquiries far from clear."

### quantity vs quality

In the printed text of Westin's address, there is a footnote reference at this point to his forthcoming book, *Information Technology in a Democracy*, which Harvard University Press will publish this year. Presumably, the adequacy of American political skills to cope with current national problems will be discussed at greater length there. But it's too bad there wasn't more discussion of the point at the Brookings seminar — particularly of whether politicians are sufficiently

aware of the *technical* limitations of quantitative data as a problem-solving tool. Numerous critics have said that social planners rely too frequently on quantitative measures to resolve qualitative problems, that government policymakers put too much faith in sampling and design statistical surveys to support their own, or the Establishment's, pre-conceived biases.

The seminar represented a rare opportunity for a large group of diverse specialists in the audience and on the platform — composed of lawyers, social scientists, information processing technicians, bureaucrats, students, and businessmen — to exchange views on a point that underpins the whole question of how much data the government really can use, the kinds of statistics that should be collected, and the degree to which personal privacy should logically be protected.

—PHIL HIRSCH

## TRADAR: WHAT LOOKED LIKE A BIG WINNER BECAME A NOBLE EXPERIMENT

Only a few months ago, the General Electric Co./J.C. Penney Co. "marriage" was running smoothly (June '69, p.135). GE showed film clips of the J.C. Penney Glendale store in its advertising as a part of its success story. Representatives from the retail chain, in turn, claimed that the on-line real time cash register replacement system was experiencing less than 1/10 of 1% down time, and predicted that communications costs for a 50 store network would run less than \$2/terminal/day. The clerks liked the machines. Outsiders pointed to the partnership that developed the system as a good example of what can happen when a user enters the design phase of a computer-based system to help produce a hardware and software configuration that really meets his needs.

Then, just before Christmas came divorce court. Penney's yanked the terminals out of its three Los Angeles area stores and went back to cash registers and manual inventorying. The clerks went back to manually figuring tax and multiple item additions. GE went back to Phoenix.

The reason given by Penney's for the sudden disenchantment was that "bugs" had developed in the system in November and that the risk in keeping the machinery going during the Christmas shopping rush was just too great. What had begun as the first big-time real world attempt to bring computing power into the stores turned out to be a "noble experiment," and was talked about unoffi-

cially in terms of "we learned a lot."

The only comment to be heard was from the retail side: "We have concluded the test phase and we are evaluating the results of those tests." GE was in the uncomfortable position of having to take its lumps quietly. According to a contract agreement, announcements concerning the system required joint approval, and JCP had clamped the lid on.

### off to a nice start

The Tradar (Transaction Data Recorder) system was put into operation late in 1967 at a single Penney's store in Glendale, Calif. The trial was later expanded to include two more Los Angeles stores. Based on two GE 435 computers, one of which was used primarily as a back-up, Tradar was expected to eventually handle 50 stores and 1500 terminals located from Ventura to San Diego.

The resulting complex seemed to work well by any standards. For instance, in the first eight months of 1969, Penney's claimed there were 17 switchovers to the back-up computer (the switch takes 32 seconds) and three other delays of less than 10 minutes each.

What went wrong? Bugs? All right, bugs can be found in any system, even years after it has been installed. But Tradar had already been used for two Christmases.

The competition may have gotten to Penney's. Friden had built another terminal and undoubtedly presented a

sales pitch. American Regitel, where some of the designers of the original terminal now reside, had introduced a terminal and computer system. And there were others, including NCR and Olivetti. Sears, Roebuck & Co. has signed with the Sweda Division of Litton's Business Equipment Group for a test run. Some of the competition offered installations based on mini computers rather than something as expensive as a pair of GE 435's at \$10K or more per month. But Penney's did not replace Tradar, only removed it.

What then? After all, Penney's had a lot of money and some seven years of R&D time tied up in making Tradar go. Now it will again be faced with conversion time and expenses if the company decides to go to another brand. Penney's is not an innovative, experimenting company. Its image instead might be called "stodgy." For the ultraconservative firm to pioneer at all was most surprising. For it to pull out now is startling.

### time to trade-in tradar

The most plausible sounding explanation is that Tradar died of old age. GE started working on it at least four years ago. And four years is a long time to be a pioneer. The terminals, modems, and software were designed from scratch and may all look like antiques now. New systems don't look much like Tradar. For instance, Tradar had an on-line ticket marking peripheral, and ticket marking requires lots of time. Tradar was communications dependent; New systems are not.

To compound the problem, one estimate held that Tradar would require 1000 terminals to be hooked up before it was cost effective. Penney's was faced with a decision, either to choose to make Tradar cost effective by building it up to 1000 or more terminals — and therefore to impose it on all Penney stores for purposes of standardization — or to drop it completely. That it made its choice abruptly is probably the result of the fact that a retail store lives or dies on Christmas sales. The "bugs" on which the whole thing are blamed may have just been the catalyst.

It is difficult to imagine Tradar being successful anywhere now, on a dedicated or time-shared basis, and since GE did not develop a follow-on project, it may again find itself in the position of having done the trail-blazing to see someone else make the profit. Tradar, and Penneys and GE deserve a great deal of credit for pioneering. They jarred a complacent industry. Now Penney's has jarred Tradar, and the second-generation system won't get a second chance.

—R. MCLAUGHLIN



# news briefs

## CONGRESSMAN BROOKS OBJECTS TO SDC REORGANIZATION

Congressman Jack Brooks has asked the Justice Department to determine whether the federal government is being short changed by the conversion of System Development Corp. from an Air Force financed think tank into a publicly owned, for-profit corporation.

Brooks, in a letter to Attorney General John Mitchell, said "the Air Force apparently has concluded that the Government has no claim of ownership, equitable or otherwise, against SDC despite the fact that, in practical terms, the government 'underwrote' the formation and development of this business entity." It appeared to Brooks that "the Federal Government might logically claim equitable ownership of the corporation and thereby be entitled to either an accounting for the total amount of the corporation's net assets, or, at the Government's option, arrange for the sale of securities reflecting the government's interest in the organization."

The letter adds that SDC has agreed to pay the government \$4 million, which supposedly represents half of the firm's current net worth. But SDC has explicitly stipulated, and the Air Force has agreed, that this payment is a gift, not required by any law. "Meanwhile," says Brooks' letter, "the Air Force plans to enter into a further accord with SDC reassigning some \$18 million in contracts to the new, publicly held corporation."

Mitchell has acknowledged receipt of the Congressman's complaint, but it probably will be some time before Justice decides what further action is necessary.

Accompanying Brooks' letter was a recent General Accounting Office evaluation of the SDC conversion plan. "In the absence of a precedent, or any guidelines setting forth steps that the Air Force should have taken in anticipation of this event," said GAO, "we do not believe . . . there is a loss of the government's rights in SDC's assets, since these assets are not legally subject to retroactive recapture." But GAO added that "we believe . . . such a realignment does present several real issues . . . which (government) agencies sponsoring nonprofit organizations should consider for future application . . ."

The issues were posed in the form of questions:

"Should any payments by the government to the corporation over and above contract costs revert back to the government upon dissolution?"

"Should all or part of the proceeds of a sale of stock in excess of the net worth be returned to the government in return for past participation in the creation of an enterprise?"

"If it is felt that the net assets should not revert to the government, should they at least be considered as the equivalent of net income . . . (and be) subject to . . . income tax laws . . .?"

Besides Brooks, the Association of Independent Software Companies is known to be unhappy about SDC's metamorphosis into a for-profit company, and has complained to the California attorney general. His office is said to be evaluating the complaint, but whether, and when, he will take action is unknown.

On the West Coast, SDC officials told DATAMATION that they "welcome" Congressman Brooks' interest because they want to operate in full public view and resolve all suspicions.

SDC insists, however, that the federal government has no legal right to any payment because SDC's original agreement with the Air Force didn't provide for the company's assets — in the event it was dissolved (as is now happening, technically) — to revert to Uncle Sam.

## GE RESHUFFLES IN THE NEW GAME

"Streamlining" and "bolstering" the marketing and advanced systems planning operations are the latest moves in General Electric's reborn effort to climb up in the list of major computer manufacturers. It wasn't the first such change in GE's computer history by a long shot, but it was the first made under Hilliard Paige, vice president and group executive for the Information Systems Group since mid-69. And it also indicates some results of a three-month planning session of top GE technical and management personnel at Hollywood, Fla., last fall.

Paige coupled the organizational announcement with the disclosure that 1969 was the best year ever for GE computers.

All details on the changes are not in yet, but the major moves are as follows. The domestic marketing for all GE computer lines is being consolidated into the new deputy division, Information Systems Programs, in Phoenix, Ariz. This operation, part of Information Systems Equipment Div., was previously called Information Systems, Sales & Service (ISS&S) and continues to be headed by Dr. Thomas Vanderslice. What this means is that the Small Computer Marketing Operation (for the 100 line), formerly reporting to ISS&S but operating separately in Bridgeport, Conn., will be moved and absorbed into ISP. The 10-year-old Information Management Operation, under ISS&S and located in Schenectady, will be closed. It was a consulting and software group serving GE and outside customers.

GE spokesmen called rumors of a 30% personnel cutback "ridiculous," noting that its sales force is being increased and had doubled in 1969 alone. "Streamlining" inevitably means some cutback and management changes, but plans were not firm at writing and the only comment was that any cutbacks would not be major.

The professional personnel of the SCOMO and IMO operations will be shifted either to ISP or to the new Advanced Systems Division (ASD).

One could speculate that the marketing consolidation should help in the current sale of networks with small satellite computers, in plans for what may be a new small-to-large-scale "family," and in the provision of more consulting and programming services to GE users under its bundled environment.

ASD replaces the Advanced Development Resources Planning Division and will remain in Bridgeport, Conn., under Richard Bloch, who took over ADRP over a year ago. And of course, developing GE's new product line, which presumably will be more extensive than past GE offerings, is the ASD charter. Design plans for this line were said to have been firmed up at the Hollywood session.

What kind of year was 1969 for GE? Equipment revenues for the Information Systems Group were up 15%, the order rate was up 20%, and the shipments and backlog of equipment were "substantially higher" than for '68. (As is common for manufacturers, no figures were given.)

Orders for the GE-600 line were greater in 1969 than for the total of the previous four years since its announcement. The 200 series, announced nine years ago, continues to "remain out in lease in healthy numbers and is profitable." The 400 line had its best year and "it is now clear that this line will be profitable over its

life cycle," said GE.

The Information Services Division (time-sharing), whose reorganization was covered here in January, p. 163, was up 30% in revenue over '68, and had doubled the number of contracts from about 2,000 to 4,000. Paige noted that acceptance of the Mark II service on the big 635 systems was exceptionally rapid, permitting consolidation of the 17 centers into larger regional centers.

And last but certainly not the least of GE's bright spots, after years of overseas losses, GE Information Systems Italia was profitable for the first time in 1969 and Bull-GE in France "soon will be," which reportedly means this year.

### ALL IS SERENE WITH TWO IBM USER GROUPS

If the experience and views of two IBM user groups headquartered in metropolitan Chicago are typical of such organizations, their future is hopeful and their relations with the manufacturer serene. Both CAUSE (College and University System Exchange) and ECHO (Electronic Computing Hospital Oriented) are growing; both say they have had no problems with IBM that have not been solved after amicable discussions.

Each group was built upon informal meetings of users who sought to exchange programs. That is still a primary function of ECHO, which enables its members to meet at semiannual meetings, to work at technical problems, to exchange ideas and programs. With CAUSE, the university IBM users, that activity seems to have taken second place to programs at its conferences that stress managerial administration rather than the guts of operational program information. It is the impression of CAUSE's Carl W. Vogel, secretary and treasurer ("a misnomer, no dues, no treasury"), who directs systems and programming for Northwestern University, that today fewer programs are exchanged among the 160 members than had been the case when the group was first founded seven years ago. He attributes this decline partly to the changed emphasis in conference programming. "The early members already have made their exchanges, the newer ones seem to be less interested," he says. He agrees that unbundling may restore program exchanges.

Hospital IBM users in ECHO, on the other hand, exchange programs with undiminished frequency, according to William H. Isaacs, executive secretary. He sees even more program exchanging because of IBM's unbundling. His group, which now numbers some 700 members from more than

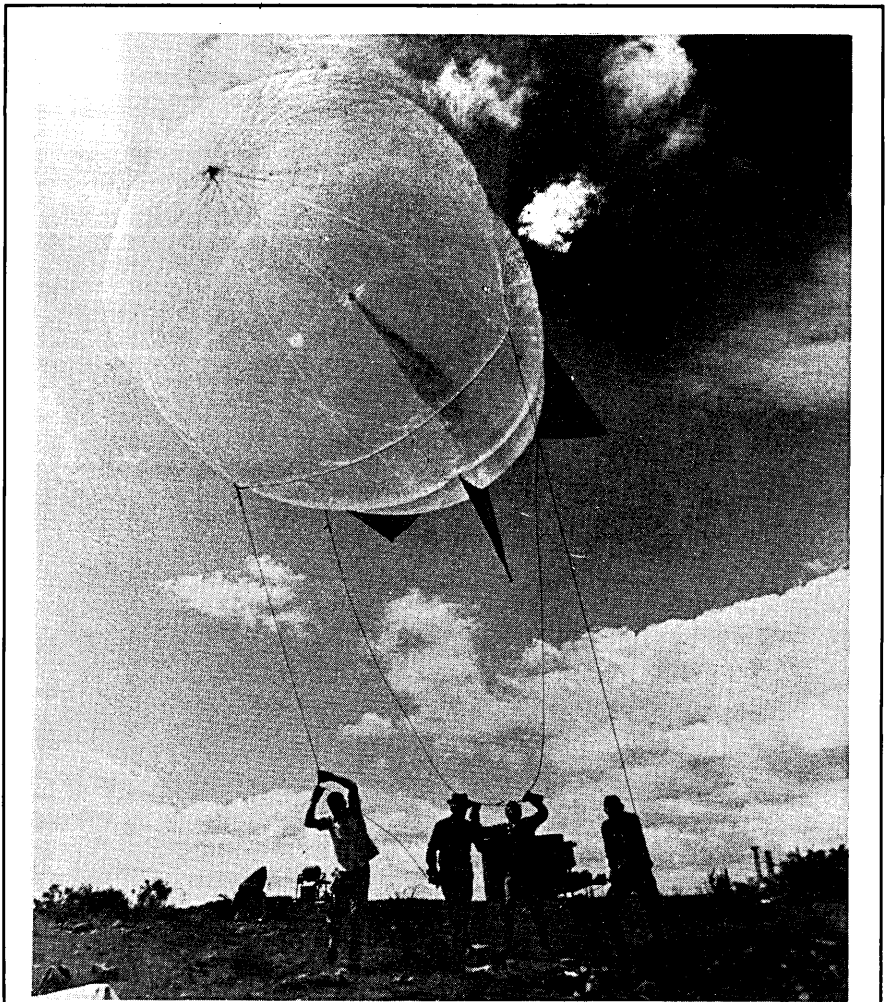

### ONE COULD WRITE A BOOK ABOUT NOVEL EXPERIMENT

On the top of a 10,600 foot peak in the Magdalena Mountains of New Mexico, there is a laboratory that would fit into a science fiction novel more convincingly than it fits into its remote surroundings. In and about it, scientists perform unusual experiments with electricity. The setting is always in a thunderstorm, and the thunderstorms are repeated, day after day, with a regularity matched in only a few parts of the inhabited world.

As a matter of fact, the regularity of the storms is the main reason that Langmuir Laboratory is there, for its technicians are attempting to explain storms, their origins, and their mechanisms. To do this they have come from all parts of the free world, including Canada, England, Japan, Israel, India, Denmark, and Switzerland.

Some of the experiments come directly from the imagination. For instance, one group has stretched a thick, 7,000-foot long steel cable between two mountain peaks. Lightning attracted to the cable will be analyzed, but in addition, a 100,000 volt electrical generator is

attached to the cable, which is used to induce electrical changes in the clouds by forcing man-made electrical charges into them.

One specialist fires instrumented rockets. Another uses balloons. One more flies through thunderclouds gathering air samples and examining them for radon, a radioactive gas emitted naturally by the earth. Still another experiment involves setting up sensing units in a nearby plains area, measuring fields and forces along 10 miles of a perfectly straight north-south line.

Information from all of the experiments is gathered and put in sync. Among the data gathered are figures on pressures, horizontal and vertical wind components, electric fields and discharges, air conductivity, lightning strikes, current flows, and air movements. The figures are used to mathematically recreate the storm within the lab's IBM 360/44. Using that model, the scientists hope to explain how tornadoes get their energy concentrated, why heat energy is changed into electrical energy, and, eventually, how to control the process.

# If your office isn't exactly surrounded by good keyboard operators, we can train as many as you need.

We specialize in increasing the productivity and accuracy of computer input equipment operators—experienced employees as well as new operators.

For example, when the Book-of-the-Month Club moved its offices to Camp Hill, Pa., they discovered there weren't enough key punch operators available. So they called us in. And we trained the operators they needed from scratch. In just three weeks.

We increase the productivity and accuracy of existing operators, too. We do it by reducing operator errors by 50% to 80%. And by increasing speed from 15% to 40% with corresponding expense savings.

*Computerworld* concluded, in an independent study, that the average increase in operator productivity is 22%.

So it's no wonder that top Fortune companies like AT&T and Mobil Oil use our services. So do 4 of the top 5 banks listed by Fortune. And 8 of the 10 leading insurance companies.

We train for whatever type of keyboard-operated equipment you have. Key punch, magnetic tape, typewriting, CRT, calculating, etc.

#### How we do it.

KTI has the specialized talent, techniques, and materials. Also, our training is "operator oriented" instead of "machine oriented."

#### Where we do it.

KTI is unique. We do not operate schools or conduct classes in the usual sense. We work only with employers.

KTI trains on-the-job or off-the-job. Our professional instructor will work with your operators on your own equipment and primarily on your own documents.

#### What it costs.

The amount varies. But savings in the first year usually exceed five times the investment. So the service pays for itself in 9-13 weeks.

#### Free consultation or appraisal.

For a free consultation about KTI, or a brief appraisal of your present operators, write or call us. Then, you can have as many great keyboard operators as you need. No matter where you're located.

**Keyboard Training Incorporated** 

**We make your operators as good as your equipment.**

292 Madison Ave., New York, N.Y. 10017. (212) 889-2430.  
Nationwide: Boston (617) 742-3522. Chicago (312) 298-4170.  
Cleveland (216) 762-4431. Detroit (313) 352-1133.  
Hartford (203) 249-9309. Los Angeles (213) 386-5650.  
Philadelphia (215) WA 2-8651. San Francisco (415) 552-3980.  
Washington, D.C. (202) 638-3890. Toronto (416) 225-2535.



FLASH...ON SITE DOS OPERATOR TRAINING PROGRAM NOW AVAILABLE.

## news briefs guide . . .

Brooks Objects to SDC . . . . .	164
GE Reshuffles . . . . .	164
CAUSE and ECHO . . . . .	165
Stormy Weather . . . . .	165
Grosch on 3 . . . . .	167
Wimmix Investigations . . . . .	167
Perils of SCC . . . . .	170
Data Bank Auction . . . . .	170
GAO Studies DOD . . . . .	170

Bad Check Bouncers . . . . .	171
Computer-Aided Art . . . . .	171
AF Seeks Software . . . . .	172
White House Telecom . . . . .	172
OTC Stock Service . . . . .	175
Heart Monitors . . . . .	175
EDP Salary Survey . . . . .	177
Perot's Pilgrimage . . . . .	177
Australia and Burroughs . . . . .	179
Distribution with EDP . . . . .	179
UCC Spends and Gets . . . . .	182

New Leasco Company . . . . .	182
Canadian Data Drain . . . . .	182
Brittanica and Microfiche . . . . .	182
European Service Centers . . . . .	184
Same Mistakes in U.K. . . . .	184
CRT's for Airlines . . . . .	184
New Companies . . . . .	187
Mergers, Acquisitions . . . . .	187
News Paragraphs . . . . .	188
News Shortlines . . . . .	189
Call for Papers . . . . .	189

300 hospitals, has been attracting nearly 300 members to its two-and-a-half day conferences, each of which has been larger than its predecessor.

At present both groups restrict their membership and meetings to IBM users, though in each there may be a possibility, still faint, of eventual change. Isaacs refers to a minority group that wants ECHO opened to all, especially now that unbundling has taken place, and admits such a possibility but doesn't see it in the immediate future. Carl Vogel also agrees that some day CAUSE may open its membership to all university people, though he points out that higher education overwhelmingly is stocked with IBM equipment anyway. The group's leaders are holding a mid-February meeting in Chicago to discuss a possible redefinition of goals, but for the time being it seems clear that no radical change will take place.

Relations with IBM are cordial. In ECHO's early days, recalls Isaacs, conferences featured a two-hour gripe session with IBM executives but those have been since discontinued for lack of substantive complaints. Isaacs also observes that his group's officers are in continuing touch with IBM's top medical marketing people, a fact that advances communication and eliminates misunderstandings before they get out of hand.

Neither organization expresses concern over what has been reportedly a fear of some user groups — the possibility of suit for restraint of trade or the publication of material that might be considered defamatory. Neither one can see where it might possibly be vulnerable to such litigation and indeed both say the possibility has never occurred to them. Told that one user group has warned supplier-speakers to stick to technical information and avoid the mention of prices, ECHO's Isaacs replies that price information is exactly what his members seek at conferences. He points out also that the group's newsletter states that any information it contains may be used by anybody, though the newsletter is mailed only to members.

### GROSCH BUCKS THE SYSTEM/3

Dr. H. R. J. Grosch, the federal government's chief dp standardizer, has asked the General Services Administration, the chief federal buying agency, to boycott IBM System/3.

In a recent letter to GSA Assistant Commissioner George W. Dodson, Grosch recommended that the federal government "not procure System/3 equipment, except under compelling circumstances of particular applications. If department and agency heads claim such compelling circumstances, they are . . . required to coordinate their reasons with us (the National Bureau of Standards)."

Grosch is unhappy because System/3 doesn't conform to ASCII code standards, and because "its clear incompatibility with existing hardware and software, both IBM and competitive, hinders government efforts at interchangeability of equipment and programs."

Why the letter was written is something of a mystery, since regulations for coping with such incompatibilities are already in effect.

One knowledgeable source suggests that the letter was really addressed to IBM, not GSA.

"Grosch was telling Watson that IBM will have to accept ASCII in particular, and federal standards in general, if he wants to do business with Uncle Sam. Both Grosch and Watson know that a version of System/3, capable of accommodating 8-bit transmission code, and hence potentially ASCII-compatible, is being produced in Japan."

### MIXED REACTIONS TO WIMMIX PROCUREMENT

Final specs for the Wimmix (World Wide Military Command and Control System) update were on the verge of being released to bidders as we went to press, but two Congressionally inspired investigations of the big procurement could delay ultimate award of a contract.

One investigation is being conducted by Sen. John McClellan's Government Operations Committee, the same group that kicked up a fuss over Phase II in 1967 and helped "persuade" the Air Force to hire Burroughs after tentatively selecting IBM.

The other Wimmix inquiry, ordered by the House Appropriations Committee, is being conducted by the General Accounting Office.

The appropriations committee will have a chance, very soon, to slow implementation of Wimmix, when the group begins considering DOD's FY '71 budget request. Delay at this juncture isn't likely, though, because relatively little money is going to be needed for Wimmix in FY'71, and virtually all of it is for personnel, equipment rental, and other activities financed with un-earmarked funds.

Precise figures aren't available on how much Wimmix will need in the coming fiscal year, but the magnitude is indicated by one knowledgeable source who estimates that "about seven" systems are to be installed by the end of FY'71 (June 30th, 1971). Over the succeeding two fiscal years, 27 more installations are planned. Presumably, DOD's big confrontation with the House Appropriations Committee concerning Wimmix will come next year, when money for a larger number of subsystems will be needed. Wimmix planners probably can evade such a confrontation by asking for only a little more money in FY'72 than in FY'71. They face another hazard, though, that may be less tractable.

The nature of that hazard is suggested by one GAO official's comment that "we are looking at Wimmix substantially in the same manner we looked at Cosmos." The latter is an Army logistics system. As a result of GAO's Cosmos study, Army planners halted further implementation of the system and began an agonizing reappraisal that is still underway. The basic question is whether the functions performed by Cosmos should be taken over by Cocons, a larger, multifunctional dp system that has been

(Continued on page 170)





# Unbearable input?

It takes a lot of berries to feed a big input-bound central processor.

That's why Inforex developed Intelligent Key Entry™.

Inforex feeds hungry CPU's. It does electronically what other forms of data entry do mechanically.

**The Inforex system** gathers data from eight keyboards into one disc memory unit. Data may be sight or key verified. Built-in logic performs check digits, left-zeros and balance totalling. Jobs are pooled onto 7 or 9-track compatible tape. Optionally, it will operate on-line directly to your central processor.

#### **Keypunch/verifier functions.**

Starting with the familiar 64-character keyboard, each Inforex keystation performs all keypunch and verifier functions: Automatic check-digit computation. Automatic left zeros. No digit by digit keying is necessary. Electronic skipping and duplicating rather than mechanical. Auxiliary duplication or two additional levels of program control. Automatic + or - signing of fields.

#### **Simultaneous entry and verification.**

All eight keystations input to one disc memory unit. Each keystation is assigned an area as it enters. Any keystation can access any assigned area at any time.

Since each keystation has both sight and key verification capability, one keystation can verify work entered on another and if desired, verification can be done simultaneously with data entry.

#### **Keyboard to tape functions.**

Inforex automatically pools input from up to eight keystations onto 7 or 9-track compatible tape. One easily entered statement transfers a series of batches. Only one keystation is required to initiate the transfer, and all keystations are functional during transfer. There are no cartridges to handle or identify, no special equipment needed for pooling.

#### **Recallable programs.**

Each program has 4 levels of control. Once the program is keyed, it can be stored for future use and recalled by any operator merely by keying its appropriate program name. There's no program card or tape mounting and no repetitive program control keying.

**Self-balancing.** Zero balancing is an integral part of the Inforex system. Each operator may accumulate a control total during data entry. Edit controls allow rapid correction. Adjustments to the balance total occur

automatically during verification.

**128-character records.** With Inforex Intelligent Key Entry, the record length is variable up to 128 characters.

**Full record display.** For added accuracy, each keystation displays an entire 128-character record with moving cursor and position counter. The system has a forms capability that allows data entry and verification in a "fill-in-the-blank" fashion. Operator messages for direct interaction with the system along with search and paging of a file are standard.

**Attractive office decor.** Inforex design innovation doesn't stop with the components. Each Inforex keystation is built into an attractive contemporary walnut and black steel desk designed for operator ease and comfort. And remember, the system is electronic, not mechanical, allowing a quiet, comfortable atmosphere to work in.

**Inforex monthly rental cost is \$50 per keystation. \$560 for control unit (up to 8 keystations). \$960 for a complete 8 keystation system, including maintenance.**

Inforex, Inc., 21 North Avenue, Burlington, Mass. 01803 or, Inforex AG, Dornacherstrasse 210, Basel, Switzerland.

## “Inforex it”

## news briefs . . .

developed concurrently.

GAO criticized the Cosmos design for lacking adequate compatibility with other Army logistics systems. The Comptroller General's report also criticized "delays in selecting equipment . . . inadequacy of the initially approved equipment configuration (to provide for future needs) . . . and a lack of available qualified personnel to fill highly technical positions." Critics have leveled basically similar charges at Wimmix.

Partly as a result of the Cosmos report, the Army established a Computer Systems Command at Fort Belvoir to promote greater compatibility. Also, the Assistant Secretary of Defense for Installations and Logistics set up a special group to do more-or-less the same thing for all the military services. Today, roughly a year later, both efforts are still getting organized.

At a hearing late last year before a House GovOps subcommittee headed by Cong. Chet Holifield, GAO officials talked at length about Cosmos and the CSC. Afterward, Holifield commented that "Your presentation does not reveal a great deal of progress" (by Army or DOD logistics officials in promoting compatibility). Congressman Frank Horton of New York was also "disappointed."

Considering these portents, it would hardly be surprising if GAO's upcoming report criticizes Wimmix and recommends basic changes in organization, design, and/or implementation. If that actually does happen, the House Appropriations Committee—given the present mood of Congress—almost certainly will order at least some of the changes made before approving more money for the project.

### SCC HANGS IN THERE BUT NOT UP THERE, YET

Another development in the perils of Scientific Control Corp., Dallas computer manufacturer (Dec. '69, p. 207, Jan. '70, p. 89), took place last month when SCC filed a plan of arrangement under Chapter 11 of the Federal Bankruptcy Act that would enable it to issue 2,010,000 shares of its common stock to Great Southwest Corp., Fort Worth land developer 80% owned by Penn Central Co., for \$2,010,000 . . . a dollar a share.

SCC currently has 1.4 million shares outstanding. When the firm filed under Chapter 11, the stock (which had sold in 1968 for as high as \$68 a share) plummeted to \$1.75 bid, but with the plan of arrangement announcement, it

climbed back to \$6.50 a share. With a \$44 million (reported) backlog and a good product, it would seem that SCC is a good investment for someone and that desperation measures are out of order. But realities intrude.

Foremost among them, perhaps, is that SCC halted production in December because of its inability to meet an estimated \$200K payroll in back wages, and immediate money is a necessity for its continued operation. Another reality is the statistic, as reported by Ernest E. Specks, SCC secretary, of \$13.4 million in assets and debts of \$11 million, a rather shaky base on which to go forward confidently.

An interesting, even amusing, side issue of the matter is the suit filed against Merrill Lynch, Pierce, Fenner and Smith, the brokerage firm, by Dallas' Bank of the Commonwealth and James Simon, a Dallas businessman, for \$25 million in damages because, it is alleged, the brokerage firm "induced" them to buy SCC stock through certain "improper, irresponsible, misleading, deceptive, fraudulent, and negligent statements, representations and acts by officers and agents" of the firm. One would suppose that a large, reputable bank would maintain sufficient expertise of its own to be able to evaluate such stock purchases in the market.

At presstime, SCC's plan of arrangement with Penn Central looked to be a necessary move to comply with the U.S. bankruptcy referee's deadline for an acceptable reorganization of the firm to satisfy creditors. Whatever the outcome, SCC serves as an example of what can happen when there's too much growth too soon. And even in the throes of its demise, if that becomes the case, SCC provided a final investment thrill—speculators made a bundle in a week if they bought at \$1.75 and sold at \$6.50.

### CAN JUST ANYONE BUY A CREDIT DATA BANK?

A Boston credit bureau's plan to auction its information on over three million people brought Congressman Cornelius E. Gallagher (D-N.J.) to the fore with cries of "modern day slave auction" and "Who will the highest bidder be? A criminal? A blackmailer? Some perverted monster?"

Massachusetts State Representative Michael Daley introduced a bill to require the State Attorney General's approval for sales of this type, and the Attorney General's office and the Boston Mayor's Consumer Protection group had a quiet talk with the credit agency and it called off the auction.

However the bureau, the now defunct Merchants Reporting Service,

sold the more than three million credit files to another private credit bureau, the Dowd Reporting Service.

Gallagher, chairman of the House Right to Privacy inquiry, adversary of public data banks and advocate of personal privacy, has introduced federal bills to control credit bureau activities and the sale of name lists for direct mail use. He plans legislation similar to that for the name lists to govern sale of credit files. There is now no law regulating the sale of such information.

Mr. Daley, who represents the Brighton and Alston districts of Boston, was surprised to find no state law to prevent the auction of the credit files. He has proposed that anyone contemplating the sale of such information file a detailed plan of the sale complete with name and business of the buyer and his planned use of the information with the Consumer Protection division of the Attorney General's office. The Attorney General would have to give his approval before the sale could take place.

Rep. Daley said that involvement with the credit file auction had revealed to him other abuses of personal data. A friend with a collection agency had found erroneous information in his file at Merchants Reporting Service, he said, and edp'ers and lawyers concerned with the computer had informed him of how computerization would magnify the callous attitude keepers of personal data have for their responsibilities and the information they sell. He said he would be investigating this further with the hopes of finding means to cope with the situation.

### GAO URGES MORE DOD IN-HOUSE DP SUPPORT

Some DOD dp support now performed by commercial contractors may be shifted to in-house forces as a result of a recent report published by the General Accounting Office.

The report contends that the Pentagon can save money by loosening personnel ceilings so that more technical support is provided in-house. Some shift in this direction probably would have occurred even if the report hadn't been issued because recent changes in the law permit DOD installation managers to hire more civilians: GAO's broadside is clearly intended to produce an even greater shift.

The report recommends that the Secretary of Defense "place increased emphasis" on a review he is currently making of Pentagon commercial and industrial activities which is aimed at determining which of them can be performed in-house at less cost.

Possibly as a result of the GAO study,

DOD is also considering whether to exempt selected laboratories from civilian personnel ceilings. "We believe the results of such a test may provide a model for further extension of exemptions from ceiling controls," GAO said, adding that "We have requested OSD to keep us informed of actions taken in this regard." That is a familiar means by which the Comptroller General "persuades" federal program administrators to implement his recommendations.

How many dp-related technical support jobs will be affected by the shift is unclear. But they probably represent a large percentage of the total involved. This is indicated by the fact one of four examples GAO used to illustrate the problems created by inflexible personnel ceilings involves a data computation facility at Holloman Air Force Base, New Mexico. Two other examples involved the Navy's Underwater Weapons Research and Engineering Station, Newport, R. I., and the White Sands Missile Range. In each case, rigid personnel ceilings made it necessary to let contracts for apparently-similar work.

The Holloman data computation facility was authorized in 1963; initially it was to be staffed with a mix of military, civil service, and contractor personnel. The latter were to be phased out as soon as possible, but this couldn't even be planned until recently because the personnel ceiling prevented in-house replacements from being hired. A 1967 study showed that doing the work completely in-house could cut costs \$500K/year.

The GAO report doesn't explicitly say how much technical support work now being contracted out could be done more economically in-house. But it suggests the magnitudes involved by referring to Pentagon studies of support contracts valued at \$35 million; these studies showed that if about 40% of the work was shifted to in-house forces, it would save an estimated \$2.9 million. "In other instances, not necessarily reviewed by the military departments for economy purposes," GAO added, "contracts were awarded because of personnel ceilings although responsible officials considered these contracts operationally undesirable."

#### TWO CHECK CASHING SYSTEMS COMPETE IN CHICAGO

Two firms in Chicago and one in Los Angeles are doing their dp best to reduce the losses from bad checks accepted by banks, retailers, and supermarkets. In Chicago, Comp-U-Check System provides a monthly printout bulletin, up-dated as required, of lost

and stolen checks as well as the names and license numbers of those who have passed them. The company, offering the same service in Detroit where its IBM 360/30 is situated, competes in the windy city with Insta-Check, which sells a telephone inquiry service. The competition between the two is intense, since there are some who feel that even a large metropolitan area can support but one such company.

Both entered the Chicago market in mid-1969. From banks, credit bureau records, customers, and other sources they acquire bad-check information. They put it on tape, enabling the re-

The printout enables the clerks to verify all checks, if necessary, at the same cost (\$40 monthly for the first bulletin, scaled down according to quantities ordered by large stores). The printout may also be made available, Paskewich says, to a clerk anywhere in the store, even if he isn't near a telephone.

Supporting the telephone inquiry method, Thomas McWilliams, corporate secretary of Insta-Check, nods his head in partial agreement that the cost of savings might be great. "But the printout is not an answer," he says. "Clerks simply won't use them. They won't even examine lists of stolen

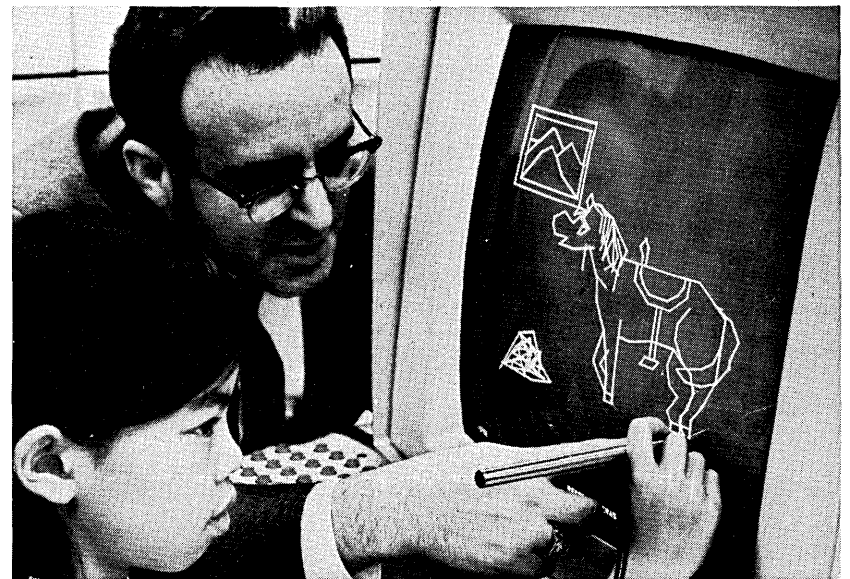

DeAnn Wu, a nine-year-old of artistic bent, studies techniques of computer-aided art and design with her teacher, George Heller of IBM DP Education Research, Poughkeepsie, N.Y. Her work "Horse" (above) was exhibited at the 1969 FJCC, along with other crt sketches by the group of "Young Computer Artists" taught by Heller, at the Second Annual ACM Computer Art and Music Festival at the ACM conference last summer.

Heller's program was experimental

and extracurricular, but he is encouraged by the demonstrated advantages of early orientation of talented youngsters to the possibilities of the computer in such fields as architecture and design. Art remains to be seen.

Miss Wu is shown working with an IBM 2250 display unit, which is connected to a 360/40. The young computer artists ranged in age from three to 82, but the three-year-old didn't produce anything "meaningful," says Heller — he couldn't reach the pedal.

tailer or banker to clear a check writer by referring to a printout or making a telephone call.

Myron Paskewich, executive vp of Comp-U-Check, explains that its printout bulletin is more practicable and less expensive than an on-line service, which it had offered until the beginning of this year. At 25 cents an inquiry, he says, a retailer of necessity is obliged to limit his calls only to larger checks, since a large operation may cash a hundred thousand checks a year. "If any large retailer called on every check he cashed, it would cost him more than he saved." Yet it is in the smaller checks where a good deal of the bad check passing takes place.

bank credit cards." He refers to a large Chicago department store that last year lost \$70,000 in bad checks. "If we can cut their losses to \$35,000," he says, "and if doing so costs them \$35,000, they're still ahead, because we can give a service simply not available when a clerk seeks out a manager who automatically puts his initials to the back of a check. That's wasted time, it delays the customer, it creates bad feelings." McWilliams also stresses that an objective of the verification service is to promote check acceptance, to encourage the use of the bank check as an easy medium of exchange. And he feels that goal is advanced when retailers are able to cash

## news briefs . . .

checks more confidently, even if initially the costs might equal the savings.

Comp-U-Check is listed as a service of the Credit Bureau of Cook County. Robert L. McCandless, Chicago's sales manager, refers to the connection as a marketing arrangement. The credit bureau offers Comp-U-Check's services, but the company must sell itself to each of its members. Before it switched to the printout, Chicago customers would call the IBM 360/30 in Detroit via Wats lines. Insta-Check is using a GE 420 operated by Technology for Information Management, a time-sharing company across the hall from its offices.

Asked how check verification differs from the work of a credit bureau, McWilliams explains that experience shows that persons who deliberately pass bad checks may have good credit ratings. Contrariwise, "the guy who is slow-pay and maybe even delinquent is not necessarily the person who writes a bad check."

The future looks good to both firms. Comp-U-Check, which went public in 1968, established a data processing division last year, and hopes to generate business for it. Chicago sales manager McCandless estimates that the company serves about 2,000 customers, though the picture is murky because of the switch-over from conversation to readout. McWilliams gives a top-of-the-head figure of 175 customers, the largest of which are several Sears Roebuck stores. At the end of 1970, he predicts, his operators, getting information at their Teletypes, will be responding to 150,000 calls a month.

Both Chicago companies are having problems with their Los Angeles counterpart, Telecredit Inc., which in 1961 was the first to market computerized check verification. Telecredit is suing each of them for infringement of patents and piracy of trade secrets. Comp-U-Check's Paskewich says that his company has instituted a countersuit for restraint of trade. In addition, each of Comp-U-Check's officers has lobbied a \$2 million suit against Telecredit for slander. Sounds like an exciting business.

### AIR FORCE SOFTWARE UP FOR COMPETITIVE BIDS

The first competitive procurement of software for government-wide use is expected to begin shortly when the Air Force issues an RFP covering an off-the-shelf system simulator.

An immediate goal of the buy is to

cut costs. Currently, Uncle Sam is paying Comress, Inc. a base price of \$3,150/month to use COMET, which is similar to the SCERT system that Comress markets commercially. The total annual cost is reportedly in excess of \$351K.

Comress is expected to be one of the two major contenders for the upcoming contract. Computer Learning and Systems Corp., which recently introduced a simulator called CASE, probably will be the other. CLSC has been marketing its system aggressively since June, 1969, and claims that at the end of last year it had signed up "more than 25 users," including some SCERT customers.

Simulators offered in response to the RFP will be tested on a 360/40-size computer, according to a spokesman for the Air Force Electronic Systems Command at Hanscom Field, Mass., the agency that will evaluate bids. Bidders will get 60 days from the release of the RFP to prepare their offerings, and the evaluation process will take about two months after the bids are received at Hanscom. The benchmark will test each simulator's capabilities to model a full range of computer sizes, and include dedicated as well as on-line t/s systems.

The General Services Administration, which inspired the simulator procurement, is known to be thinking about acquisition of compilers and utility packages on the same centralized basis — as one way of countering the price increases generated by the unbundling announcements of IBM and other system manufacturers.

Farther down the pike, according to a GSA source, the agency hopes to acquire an in-house capability for developing standardized programs — executive as well as application routines — that can be used generally throughout the federal government. Money is available to set up such an operation from the adp revolving fund authorized by the Brooks Bill, if someone can show that the cash benefits of providing software centrally are sufficiently great. The upcoming simulator buy could help set the stage for an in-house software development experiment, say advocates of the idea.

GSA is already developing some software for other federal agencies. While this activity is currently limited to application programs needed by users of GSA's regional service centers, the technicians who do the work represent a base for an expanded effort.

The National Bureau of Standards also has hopes of developing an in-house software development capability capable of serving the rest of the federal government. "We wouldn't stand in their way," says a GSA official. "They could do the development

work and we would then handle distribution." NBS probably will become responsible for testing and validating whatever standardized software GSA buys from outsiders if a centralized software procurement program is established. The Bureau could then expand this foothold, later, to include in-house program development.

Some flak from commercial software developers is inevitable, say our sources, but they believe that BOB Circular A-76 will deflect the objections. This regulation, basically, says the government can do work in-house, even though it's available from private industry, if the commercial price is substantially higher.

### COMM STAFF IN EXEC BRANCH PROPOSED BY NIXON AIDE

Establishment of an Office of Telecommunications Policy in the White House, with wide powers affecting the dp industry, has been recommended by Presidential Adviser Peter Flanigan. The proposal is still preliminary, but a knowledgeable source believes it will go to Mr. Nixon shortly for final action.

The new organization would study such matters as foreign attachments to the public telephone system, the number and character of competing data communication carriers that should be allowed, desirable uses of a domestic satellite system, additional applications of cable TV, the need for regulating common carrier dp activities, and the limits that should be placed on unregulated communication activities of dp firms; it would then develop policy proposals and send them to the President for his final decision.

Besides trying to rationalize public telecommunication services, the proposed Office of Telecommunications Policy would review procurement of "all telecommunication systems and services" by the federal government, and exercise similar oversight over the planning, testing, and operation of these facilities. The new agency would also develop "appropriate policies and standards for such systems," and "make recommendations to the Bureau of the Budget and responsible departmental officials concerning the scope and funding of competing, overlapping, or inefficient programs." Presumably, these procurement review and standards-formulation powers would include on-line dp services obtained by the federal government from commercial sources.

The Office of Telecommunications Policy would have an initial staff of 30 professionals, including up to 15 in supergrade positions. They would obtain technical support from a Tele-

# Dual Image... A New Data Entry Media

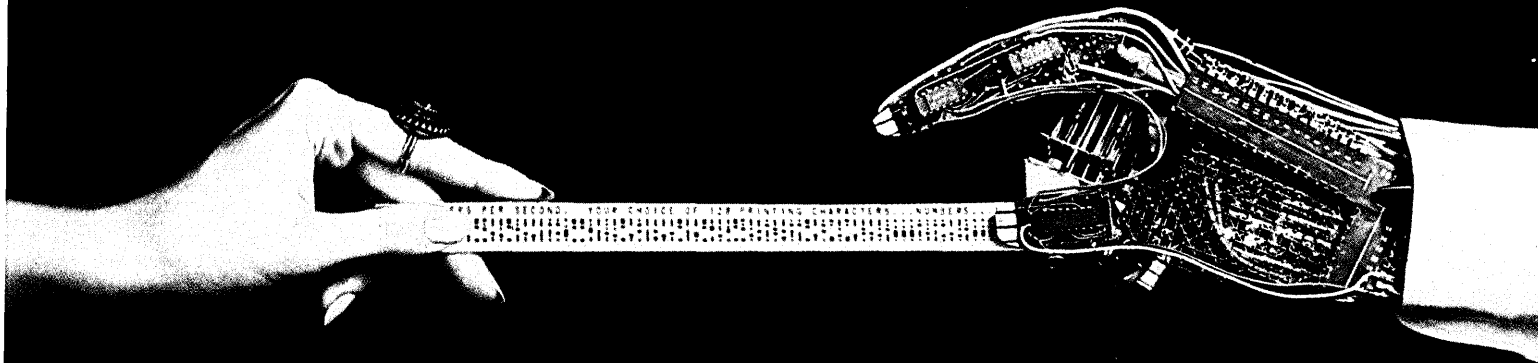

## Your People and Your Computer Can Read It Equally Well

### They're Compatible at Last!

Your people and that computer, joined hand in hand. Dual Image, a new concept in remote data terminals, provides a fast, flexible yet low-cost way to bridge the gap between man and machine. The secret of Dual Image is a unique printed tape, which combines both "display" and "storage" in a single durable media. People can read it as easily as the morning newspaper. Computers digest it as simply as data from magnetic or punched tape, CRT's, cards, or typing terminals.

### Ten Times Faster Than a Teletype

Operators will find Dual Image perfect for data capture. Each character keyed is immediately visible, just like a type-written line. Data is then transmitted over standard voice grade lines at 120 characters/sec. Your computer gets the most

data per dollar. Since the computer and the keyboard can activate the same printer, both the inquiry and response can be printed next to each other on the same tape...providing a permanent hard copy record too!

### Correcting Non-Valid Data— Dual Image Really Shines

Source document errors are quickly discovered using the computer's editorial ability. Data unacceptable to the computer is "returned to sender" with white space replacing questionable data. Correction means simply filling in the blanks, and re-transmitting. No more time wasted in finding that the computer would not accept your input...no more hooking of the right correction to the wrong record. Suspense files are gone...memory needs are eased!

### Applications Unlimited

Dual Image is excitingly new! For order entry, sales reporting, branch office accounting. In fact, applications are limited only by the imagination. Write for the whole story. It's in our full color brochure. Or, if your need is urgent, phone us at (206) 774-4156.



**Interface Mechanisms Incorporated**  
5503 232nd Street South West  
Mountlake Terrace, Washington 98043

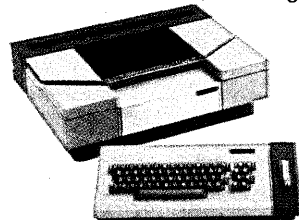



# If you haven't

signed a  
systems engineering agreement...

# read this!

From now on you'll have to *pay* for systems engineering support. And since you've got to pay for it, you'll want the best. Therefore, you should evaluate the capabilities and advantages to be gained from Computerbase Systems Representative Services.

First, Computerbase provides a complete range of services: programming, systems design, installation support and consulting. Of primary importance is the application knowledge of the Computerbase Systems Representatives. When

the Systems Engineer was learning about new hardware devices and how to implement them, the Computerbase Systems Representative was learning about customer applications and was developing his individual programming expertise.

Second, Computerbase will not hesitate to accept total programming responsibility. We will contract on a time and materials, fixed cost, or cost-plus-fixed-fee basis. This contracting flexibility provides maximum utility in managing the cost of SR Services.

Third, our complete range of capabilities reflects itself in costs. If less experienced assistance is required, Computerbase can provide it at rates as low as \$13 per hour. On the other hand, if requirements demand, we can provide Systems Representatives with several years of applicable experience.

Computerbase is a total service company. For all computer oriented services, we invite you to investigate Computerbase. For complete information, write Mr. F. P. Fisher, President.

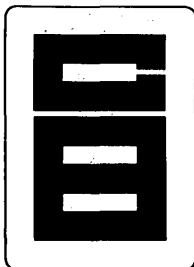

**COMPUTERBASE CORPORATION**

3810 Wilshire Blvd., Los Angeles, California • (213) 380-3511

## news briefs...

communications Research and Analysis Center which would be established in the Commerce Department. Outside consultants, commercial contractors, and a telecommunications advisory committee composed of "experts from outside government," would also assist OTP.

This organization is designed to give the federal government much greater control over the nationwide use of telecommunications, present and future. As the White House recommendation puts it: "In spite of the rapidly growing importance of telecommunications to the nation and for the government's own missions, there is no effective policy-making capability for telecommunications in the executive branch. The Administration is therefore largely unable to exert leadership or take initiatives in spite of vulnerability to criticism for FCC policies. Government-wide coordination of its own telecommunications activities has not been adequate."

Almost certainly, the new federal presence would have far-reaching effects on dp hardware and software offerings, communication rates paid by dp users, time-sharing services and charges, and industry R&D effort.

It is likely, for example, that if OTP is established, much greater use will be made of models and prototypes by the federal government before it acquires new telecommunication systems, including those utilizing computers. Probably, much of this will be done in-house, and federal technicians will exercise tight control over any contracts awarded. The specs and operating procedures developed by modeling and prototyping undoubtedly will be imposed more widely and more strictly than is the case today.

It is also probable that federal financial support for on-line dp activities — now provided through such agencies as ARPA, NAS, HUD, OOE, and PHS — would be channeled into fewer areas as a result of studies performed by the proposed agency; possibly, the whole support program would be redirected.

Another likely effect of establishing an Office of Telecommunications Policy is that changes in communications tariffs — now almost exclusively originated by the carriers — would start coming from the White House. Likewise, the same source would probably be an important source of new laws concerning telecommunication activities.

Dp industry lobbyists would almost certainly find themselves knocking on different doors, and the doors would be attached to offices located higher

on the federal organization chart. Possibly, this might reduce the interminable delays that now occur between the time policies are formulated and the time they are finally acted on. It is also possible that the government, by acquiring more in-house technical expertise, would lean less heavily on the industry for advice, which might reduce the industry's ability to affect policy.

FCC would retain its "judicial powers" under the proposed plan, says one of the officials who is helping to set up the new office. "But the FCC's present power to evaluate technical problems like the foreign attachment hassle would be transferred to the new agency."

The role of the Center for Computer Sciences and Technology, a major source of federal dp policy today, might also be reduced, but how much of a shrinkage would occur hasn't been decided yet. "The whole plan is still very plastic," says our source. "One of the key questions is how much technical support would be given to OTP by existing agencies whose mission includes telecommunications."

### BUNKER RAMO TO OFFER NEW OTC STOCK SERVICE

In December 1968 Bunker Ramo Corp. signed a contract with the National Security Traders Association to build and operate a computer-based quotation system to serve the Over-The-Counter stock market. At that time the system was expected to initially handle quotes on 1500 stocks and have users at 170 locations.

Today Bunker Ramo has the first of two Univac 1108's, the base for NASDAQ (National Association of Securities Dealers Automated Quotations), up and running. Initially the service will carry listings for 3,000 issues and be tied into 800 locations across the country. All who signed contracts before January 15 are guaranteed start-up connection. The first users will go on-stream late this year.

NASDAQ represents a \$20 million investment for Bunker Ramo. The computers and associated storage and peripherals are housed in a new Trumbull, Conn., center. The remainder of the system hardware is eight communications concentrators, reworked Honeywell 516's, four in New York City to serve the Northeast, and one each at Los Angeles, Chicago, Atlanta and Dallas, and scores of Bunker Ramo Series 2200 crt's at user sites.

The service to OTC brokers will be offered in three levels. Level one: bid and ask prices (a median price calculated by the computer from the input of the numerous market makers)

put out over the existing quotation services — Bunker Ramo's Telequote III, Scantlin Electronics Quotron service, and Ultronics' Stockmaster and Videomaster, for registered representatives. There are some 20,000 Telequote units installed and between 15,000 and 20,000 Scantlin and Ultronics units in use. The price for NASDAQ service is expected to be about \$20 per office and \$10 per terminal above existing costs.

Level two is for the retail trader — the backroomer who deals with the market makers for the registered reps. The trader will use a B-R Series 2200 crt and be able to get all the market makers (sometimes 25 or more) buy or sell quotes on specific issues. From the displayed list, which is updated five seconds after any change in a quote, he can select whom he wants to deal with. He will complete the deal by telephone or however he does now. A single terminal will rent at \$350 a month, less in quantity.

At level three the market maker will be able to interrogate the system for buy and sell quotes on stocks he is interested in and will also be able to change his own quotations.

Bunker Ramo will be sole service for level two and level three service. Users of the service will have to meet NASD criteria and be approved by the securities dealer's association.

In addition to on-line quotes for daily trading NASDAQ will generate the OTC indices, updated every five minutes, to all users and an end of day listing for the news media.

Currently the OTC market is being served by STAQ (Security Traders Automatic Quotes), an interim system operated by Bunker Ramo. It includes some 1200 stock listings and 100 or so users and will be discontinued when NASDAQ gets on the air.

### TOBACCO COUNTRY HOSPITALS MONITORING HEART ATTACKS

Remote computer terminals are playing nurse to heart patients at Duke Hospital in Durham, N.C., and will soon be put on the job at eight cooperating Marlboro country hospitals. The terminals are used in monitoring heart patients before and after surgery, and in compiling characteristic patient profiles and averages. Using them, the doctors hope to someday have gathered enough data so that they will be able to predict heart attacks.

Now, when a patient suffers a heart attack and is scheduled for open heart surgery, he is taken to the catheter lab where a number of measurements are taken, including an EKG and blood pressure readings. The measurements are sent to Duke's central computer

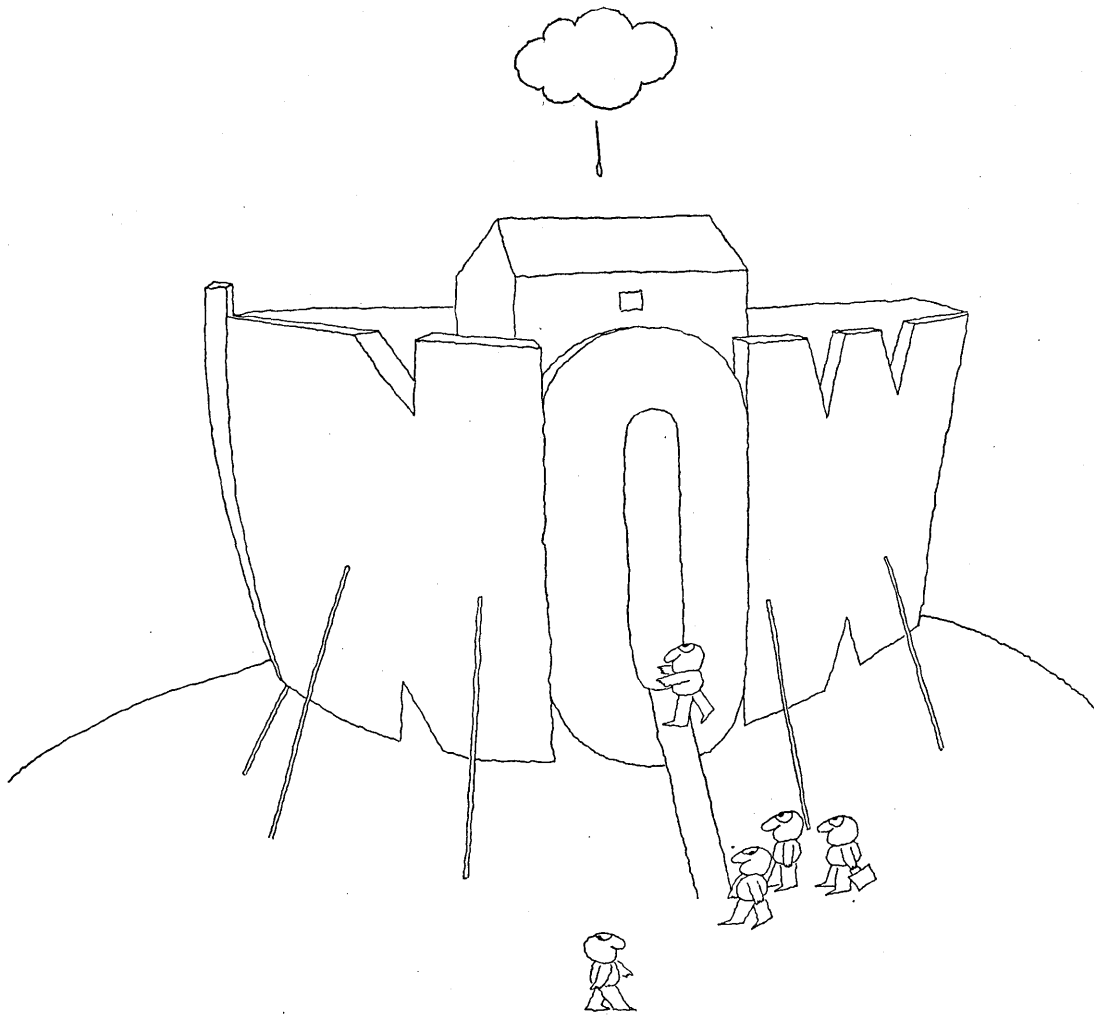

## Now. Before it's never.

The sea of data needed to run a modern business is at high tide.

The information on which decisions must be based is threatening to engulf the deciders.

In order to shape your course, you have to find out what you need to know, when you need to know it. Which is now.

Univac can help you navigate in the now with on-line, real-time information systems expressly designed to channel a chaotic flood of data.

The UNIVAC® 9000 series systems

offer an unmatched level of data processing power in the low and medium price field.

They are widely used as either central site systems or terminal systems. As terminals they may be upgraded, without reprogramming, in low-cost steps to grow with your processing needs. The UNIVAC 9000 series systems are compatible not only with UNIVAC systems but with most other systems too, and they can operate on a wide variety of line speeds simultaneously

with several central processors.

We can help bring you real-time management for the first time. An end to tidal onslaughts of unorganized data. A beginning to constant command through constant information.

The time to get on board is now. The way is by calling us. We know these waters well.

**UNIVAC** SPERRY RAND  
FIRST IN REAL-TIME INFORMATION SYSTEMS

## news briefs . . .

site through a Computer Communications crt terminal (a CC-30). Four of these terminals link to a CC-72 multiplexer, to a CC-7014 channel interface, and finally to the center's 32K Sigma 5. In addition to these compo-

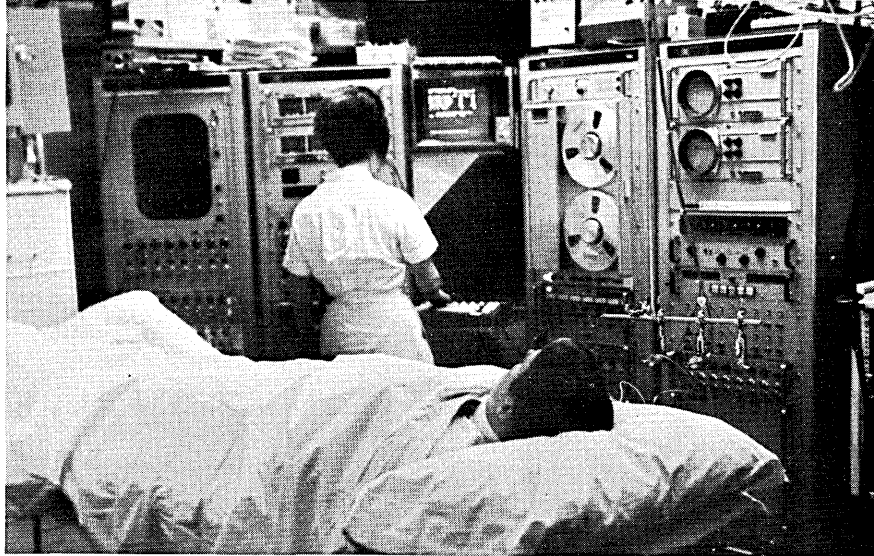

After open heart surgery the patient will have a better chance if one of his nurses is a computer terminal.

nents, the hardware configuration includes 15 megabytes of RAD storage, a printer, card reader, tape units, two analog to digital converters, 16 digital to analog converters, analog multiplexers, etc.

After surgery the patient is taken to the recovery room where he is connected to various measuring and monitoring devices. The data from these is entered through another CC-30 to the Sigma 5, which uses the new

readings, along with the baseline readings, and returns results of its computations in 30-40 seconds.

In the past, these tests and the associated computations could take a good deal of time. Theoretically, a patient could expire before corrective action could be taken. Now, the doctor is free to take continuous series of tests. Graphs and plots can be called for. Prognosis becomes more positive,

and medication can be prescribed more accurately.

The patient is kept in this environment for five or six days. Then he is transferred to his room, where he is again monitored, although not as closely, until he is beyond danger. Finally, the history of his case, his data profile and recovery become part of a permanent data base. The next incoming patient is compared against that base, and the cycle repeats.

### SALARY SURVEY DISCLOSES LARGE EDP DISPARITY

The Merchants and Manufacturers Association in Los Angeles recently completed its Electronic Data Processing Salary Survey for the southern California area, compiling reports from 171 firms with a total employment of 422,569, including 7,100 employees in data processing job classifications. The survey indicated that the average of salaries for programmers and systems analysts increased 3.73% from 1968 to 1969, and the average for computer operators rose 3.33%.

All job categories showed a wide range of salaries, but perhaps the most striking was that of manager, data processing, which went from a high

monthly rate of \$2,665 to a low of \$680. Next lowest was \$860, and one wonders who that \$680 man is and where he labors and does he know he is alone. The median salary for this category was \$1,460 monthly, and included both business and scientific application positions.

The programmer trainee level ranged from \$390 monthly to \$1,020, with a median of \$700. It was noted that people in this category rarely remain at this level longer than 18 months and most move up to the intermediate programmer strata much sooner. The intermediate range was from \$580 to \$1,235, with a median of \$850.

The salary for a senior programmer (who may be an old man of 30) encom-

passed a low of \$675 and a high of \$1,665, with a median of \$1,025. A senior programmer, according to the survey, "is not supervisory or a permanent project leader," which may come as a surprise to some senior programmers. However, when he moves up to supervisor, programming, the least he can expect is \$900 monthly, with a rarefied \$1,920 as the most, and a median of \$1,235.

This compares favorably with the rates for supervisor, systems analyst, regarded by some as an esoteric, administrative job. The high here was \$1,885, with a low of \$985, and a median of \$1,255. It hardly seems a step upward from the supervisory programming level, except perhaps in prestige. A senior systems analyst ranged from \$815 to \$1,740, with a median of \$1,160.

The median monthly salary for a computer operator trainee was \$540, \$610 for an intermediate, and \$700 for a senior. A supervisor of computer operations ranged in salary from \$530 (Where is he? Does he know?) to \$1,450, with a median of \$895.

A junior keypunch operator worked for as low as \$320 a month and a high of \$615, with an average of \$470. A senior keypunch operator's figures were \$375, \$680 and \$505. A keypunch supervisor made \$1,125 tops with a low of \$520 (What does he do with a \$615 junior under him?) and an average of \$704.

Median salaries for other computer support jobs were \$550 for a tab machine operator, \$785 for a machine accounting/tabulating section supervisor, \$495 for a data recorder operator, \$725 for a data processing scheduler, \$505 for a data control clerk, and \$500 for a magnetic tape librarian.

Among the 171 participating companies were Coca-Cola of L.A., Burroughs Corp., CBS, Inc., Getty Oil Co., Lockheed Electronics Co., The Prudential Insurance Co., and Western Airlines. Three of the participating firms preferred not to be listed. Maybe there is where the totem pole's lowest worked.

### PEROT'S PILGRIMAGE ENDS AT THE BEGINNING

"The Odyssey of Ross Perot," "Mr. Perot and His Quixotic Mission" — thus was the mission of H. Ross Perot to bring Christmas packages to American prisoners of war in North Vietnam characterized in segments of the U.S. press during the holidays. Perot, president of Dallas-based Electronic Data Systems, might even have been chagrined to learn that *Time* magazine identified EDS as an "incredibly

# SPEED LIMIT 960

And that's fast for a 16 bit machine  
...for less than \$10,000  
and Much Less in OEM Quantities

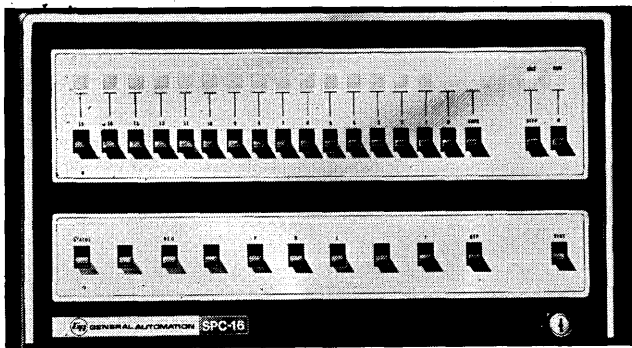

SPC-16 is a powerful new 16-bit machine... 960 nanoseconds fast ... expandable 4K memory.

It's organized to provide for efficient handling of bits, bytes and words in read/write and macroprogramming in ROM... and ready-to-use GA productized software reduces programming time, effort and cost to a minimum.

SPC-16 gives you big computing power, accuracy, reliability and programming simplicity... and flexibility in interfacing with peripherals through the GA family of mini-controllers... and the SPC-16 is supported by expert consultation, systems engineering, programming and customer training services.

You'll be surprised just how fast you can add the SPC-16 to your product or system... so find out today.

Ask about other low-cost computers in the GA family. The SPC-12 for less than \$5000. System 18/30 for under \$20,000.



**GENERAL AUTOMATION, INC.**  
**Automation Products Division**  
706 West Katella, Orange, Calif. 92667  
(714) 633-1091, TWX 910-593-1601

CALIFORNIA  
Los Altos, (415) 941-5966  
TEXAS  
Dallas, (214) 358-0271  
Houston, (713) 774-8716  
ILLINOIS  
Des Plaines, (312) 298-4650  
(California G.A. Corp.)  
OHIO  
Cleveland, (216) 351-2275

GEORGIA  
Atlanta, (404) 261-6203  
PENNSYLVANIA  
King of Prussia, (215) 265-6525  
MARYLAND  
Silver Spring, (301) 593-6010  
CONNECTICUT  
Stamford, (203) 325-3883

MASSACHUSETTS  
Waltham, (617) 899-6170  
INTERNATIONAL  
G. A. I.  
24 Blvd. de l'Empereur  
Bruxelles, Belgium  
G. A. Ltd.  
Wren House, Portsmouth Rd.  
Esher, Surrey, Esher 65764

## news briefs . . .

successful computer manufacturing company.”

Perot (April '69, p. 89) had loaded up a couple of chartered Boeing 707's with food, medicine and Christmas gifts, along with assorted staff and newsmen, with the intention of flying to Hanoi and delivering the goods to our POW's. However, only one plane ever took off and Perot's citizen-diplomacy was rebuffed all along the way, first by North Vietnam, which advised him to go through the proper channels (in this case, Moscow), and then by Moscow, which responded with a brisk *nyet*. And so the grand gesture, which cost a reported \$600K, came to an end. At last report, Perot was trying to distribute his largesse through the American Red Cross.

Speculation on the reasons for Perot's ploy was, naturally, rife. Some viewed it as a personal publicity gambit for possible political motives (in a television interview, Perot denied that he has any political aspirations). Others saw it as a simple humanitarian gesture carried out on a large, American-business type scale. And still others considered it an emotional reaction on Perot's part to the seemingly endless peace negotiations while men languish nearly forgotten in an unpopular war.

Another Perot reaction was recorded in an interview on the television program "Issues and Answers" when he offered to buy the release of U.S. prisoners of war held by North Vietnam. He said he would go as high as \$100 million if necessary.

Whatever his motives, Ross Perot's name is now known to a great many millions of people who had never heard of him before.

### BURROUGHS SALE LINKED TO BARTON'S AUSSIE VISIT

Do overseas visits by consultants to equipment manufacturers pay off in the form of orders? A recent order placed with Burroughs by an Australian institution indicates they do, at least in one case.

In Australia, advanced education budgets are based on a three-year allocation of money by the federal government. Therefore, there is a period of intense marketing of computers (and other capital equipment) just before and after new allocations are made, which most recently were announced in the last quarter of 1969 for the 1970-72 period. And thus it may have been a strategically-timed visit to Australia that Robert Barton made last July; at that time, Burroughs an-

nounced that B-5500s and B-6500s would be actively marketed here.

Barton, professor of electrical engineering at the University of Utah, is also a consultant in machine architecture and systems design to Burroughs, in which capacity he is credited with fathering the B-5500. His visit last year was something of a sentimental one in that he served from 1963 to 1965 a stint in Canberra as manager in that city for Control Data. This was the period when most of the CDC computers in the Bureau of Census and Statistics were installed. Last December, an order for a B-5500 was announced by the Canberra College of Advanced Education, some credit for which might be ascribed to that sentimental journey by Barton.

This is an important order for Burroughs. Until quite recently, the federal capital of Australia has been the preserve of CDC and Honeywell, with the exception of an IBM installation at the Australian National University. An important part of the announcement of the order is the sentence: "At the invitation of the Commonwealth Public Service Board, the college has also agreed to collaborate with the board in running courses for programmers-in-training within the Commonwealth Public Service." What do positions in such an installation pay? Four posts were advertised on the day the announcement was made. Translated into U.S. dollars, directors' salaries range from \$8,561 to \$9,670; systems programmers, \$7,944-\$8,930; applications programmer / analyst, \$7,201-\$7,696; and programmers, \$5,720-\$6,956. These salaries are slightly above the average for Australia.

### EDP FIRMS WOO DISTRIBUTION INDUSTRY

Edp marketers seem a bit more interested in the distribution industry these days, though the opposite is still not true. Several firms have come up with packages designed to move and keep track of the goods.

Universal Systems, bought on New Year's Eve by Singer & Mackie, has a package called COSMA (Computerized Service for Motor Freight Activities). It's installed at Jacobs Transfer & Storage, and rates, formats and prints bills of lading, road manifests and billings, and gives Jacobs a daily recap report. An on-site tty communicates with USI's dual Sigma 5's (one redundant) at Rockville, Md.

USI chief marketer Mike Hantman says "... although Jacobs rates only about 100 bills of lading a day, we now have clear indications that the system is going to work well." Hantman says they also have four or five letters of

intent from truckers, and even interest from the shippers themselves.

Philco-Ford and Chase Manhattan both have comparable rate retrieval systems, but, reportedly, neither rates bills automatically.

USI charges about 40c per bill, vs. a reported '68 national average of 91c per bill, and as high as \$1.87 per bill, via the old rate clerk.

To give some idea of the profit potential involved in '69, there were about 29,000,000 bills of lading prepared in the Middle Atlantic Conference alone. In truckese, a "conference" is a geographic area, and the Middle Atlantic Conference involves only about 100 carriers out of about 1,100 in the country.

Another stimulus to computerize preparation of lading bills is the head-reeling complexity of ICC rating regulations. The latter were formulated in the mid-thirties, and not significantly amended since.

Computer Logistics Corp., Chicago, is another smallish shop that's going after the warehousing market. Bright, young marketing vp Pete Dorus says their "Logistics Data System" is shortly going into two public warehouses in Chicago, two in L.A., and one in San Francisco. (What's stored in a "public" warehouse is not owned by the warehouse: it's simply stored for local distribution.)

CLC (10% owned by Com Share) puts ttys on site, and ties them into Com Share's XDS 940s in L.A. They're charging about "10c per bill of lading, and 5c per product line item," says Dorus. Their system prepares warehouse receipts, shipping order bills of lading, maintains inventory records (on-line), prepares periodic activity reports, OS&D reports (over, short and damaged), invoices for warehouse charges, monthly accounts receivable statements, and weekly management reports (basic cost accounting types).

Dorus and associates envision a nationally integrated system tying together manufacturer, carrier, warehouse, even retailer, on a common data base. Dorus says there are about 2,600 public warehouses in the country today, and they're all really doing about the same thing. "They store nearly all basic foods, chemicals, materials, etc., consumed in the country. They're all small (about \$3 million per year), and the logistical redundancies and delays can run into big money."

Ryda Com, Miami, Fla., a sub of Ryder Truck Rental, developed a system (Distri-net) to handle Ryder's distribution problems, and is now preparing to stalk bigger game. They've contracted Micro Systems to make minicomputers as on-site buffers that will be polled daily, but they're reportedly



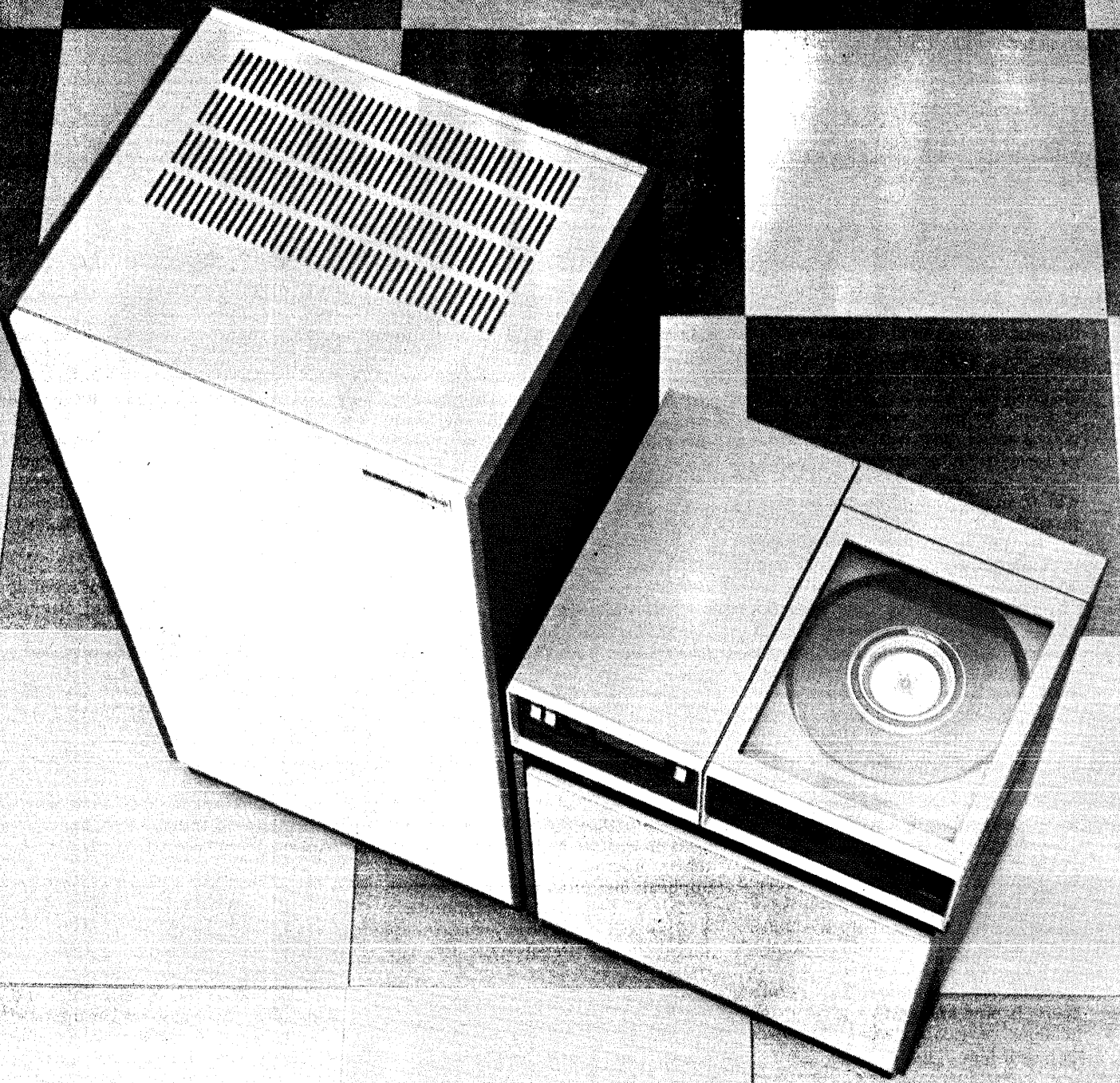

# Memorex introduces the 3660. It replaces your 2314.

Our new 3660 disc storage system, complete with controller, gives you faster access time, higher system throughput, and greater reliability than the 2314. At 10 to 20% lower cost.

The new control unit interfaces directly with your System/360. No changes in hardware, no modifications in software. A single unit controls up to nine drives.

The drive is simple.

Reliable.

Proven.

We've demonstrated the dependability of our design in millions of hours of operation on over a thousand delivered drives.

MEMOREX

## news briefs . . .

about a month away from testing at presstime.

L&H Computer Corp. has had excellent results at Couzens Warehouse in Chicago. In '67, Couzens was rating 150 bills a day. They're now rating about 500 a day, "... and there's capacity to rate three times as many, with no staff changes," says Paul Lemme, vp, and the L in L&H. Couzens is expanding, and reportedly soon may be able to offer a price break to cartage firms because of more efficient use of trucks. (And herein may well lie the rub!)

Incisive, soft-spoken Lemme, possibly one of the most knowledgeable men in edp/warehousing today, says "We provide a service, not a package. We have 200 programs here, and they're constantly being revised and updated by about 14 programmers. Warehousing is a remarkably dynamic field, constantly changing. And the static-package approach is simply not appropriate."

L&H pitched at a national gathering of warehousemen, and interest was high. But, according to Lemme, "... it's very rough to get them to sign. They'll talk all day, but they won't sign."

Conversion is one factor that apparently stays the hand of the signer. There's generally a mountain of manual data recording work the customer must do first. What may turn the trick is the increasing pressure from shippers themselves.

Shippers want "closer inventories." And there's enough money involved that interest is waxing. A familiar mustard manufacturer, for example, delighted with the service of one computerized warehouse operation in the Midwest, said to warehousemen in another city: "If you'll computerize your operations like so-and-so, we'll give you our business."

After mulling the matter a bit, the warehousemen did nothing . . . in unison. The mustard maker eventually had to give the business to one of them anyway.

But it's a beginning. Maybe enough mustard makers and enough Couzens can ease the pain of checkout at the local supermarket one of these days.

### GOVERNMENT SPENDING BIG MONEY AT UCC STORES

University Computing Corp. is filing for \$60 million worth of 25-year convertible subordinated debentures, which the company says will go to purchase equipment, reduce bank debt, and provide working capital. The equipment purchase money may

have already been spent, at Univac. UCC, through its brand new Govt. Systems Div., has set up a \$36.5 million buy from the computer manufacturer. The hardware to change hands will include a handful of Univac 1108's and a smidgin of communications gear.

But the 1108's et al. will not be delivered to UCC, but to the government instead. UCC has already contracted to lease the equipment to the government for use in the AUTODIN communications network and in the Air Force's weather network for an aggregate rental, under published GSA terms, of about \$17 million yearly. (Let's see, in three years UCC would realize a \$14.5 million profit plus own the machines, right? Doesn't sound like they will be hurting for working capital after that.)

### LEASCO FORMS NEW SUBSIDIARY

Leasco Data Processing Equipment Corp. has formed a new subsidiary, Leasco Systems Corp. The new entity will take over the services of Leasco Systems & Research Corp., except for administration of time-sharing and information products services.

A Leasco spokesman said that eventually all Systems & Research activities would be transferred to Systems Corp. He characterized Systems & Research as Leasco's "federal systems group" and said the new corporation would facilitate the shift of service emphasis from the federal government to general industry. He also said a new corporate structure is sometimes needed to provide the inducements — stock options and the like — for recruiting new talent. The company also anticipates public trading of Leasco Systems Corp. at some future date.

Among the services Systems Corp. will initially offer are systems design, facilities management, leasing, education and training, and remote batch processing. The new group will be headquartered in Chicago. Robert E. King, a 12-year IBM veteran and vice president, computer services, for Leasco for the past five months, was named president.

King is another step in the IBMization of Leasco. He's the third ex-IBMer to step into an executive post following Carl Vorder Bruegge, vice president and group executive for Leasco Computer Services, to whom he reports, and Frank McCracken, Leasco president.

The Leasco spokesman also answered questions raised about the company's marketing a line of peripheral equipment. It still plans to do so but won't until it has what it consid-

ers sufficient marketing clout.

Business at Leasco for the past fiscal year appears to have been quite good. Its annual report notes a 60% increase in earnings to a record \$43.9 million. Computer consulting and leasing services provided \$10,152,000 of this and insurance operations \$16,548,000. The other \$17,228,000 came from gains on investments. Revenues for computer consulting, leasing and services were \$100,992,000, and total revenues were \$452 million.

### CANADA CONCERNED ABOUT POSSIBLE DATA DRAIN TO U.S.

Canada's federal government is worried that, through its use of U.S. computer banks, essential and strategic information may fall into the wrong hands. The feeling among federal officials is that Canada may find itself powerless to stop important economic, social and even strategic information from leaving its borders.

An intense study is currently being made by experts in the federal Department of Communications. As of now officials aren't even aware what data has in fact been sent out for storage in U.S. computer banks.

Communications minister Eric Kierans touched on the issue in a recent Montreal speech. He said: "We are faced by the fact that we have already developed computerized data banks without the faintest notions, let alone legislation, about what types of data banks would best serve the public good, what types of information should go into these banks, what safeguards for personal privacy should be imposed."

For example, should data on Canadian geological surveys be considered strategic if and when it becomes computerized? The same question applies to exploration activities in Canada's Arctic. Federal officials believe that the sovereignty problem at the moment is peculiar to Canada. They point out that the U.S. is the world leader in computer technology and outwardly doesn't appear to be bothered by the potential problem of data drain, because most of the data storage and retrieval computers are, and will likely remain in, U.S. hands.

### READ THE SMALL PRINT

A very small and secretive Los Angeles firm, Image Enterprises, has apparently walked away with the pot after a six-month bidding battle involving some of the ultramicroform industry's top companies, NCR, Eastman Kodak, and Itek. The pot contained a multimillion dollar contract — called



## Uni-Spray™ coating: it turns precision discs into precision disc packs.

Uni-Spray is the only process that doesn't rely on spin-produced centrifugal force to disperse magnetic coating over disc surfaces. We spent six years developing it. And it's exclusive with Memorex.

By spraying the coating on, we get extremely even dispersion of magnetic particles within the coating.

There are none of the clumps, voids, and tunnels that cause soft errors in spin-coated discs.

Uni-Spray also results in a tough, scratch-resistant coating that won't produce the kind of shed that can cause a catastrophic head crash.

To make doubly sure we eliminate errors, we "worst-case" test each pack on our marginalized 360/40 computer.

And finally, each precision Memorex disc pack has a Five-Year Warranty — the longest in the industry.

Ask your man from Memorex about Uni-Spray, or write for our free Uni-Spray brochure: Memorex, Santa Clara, California 95050.

## news briefs . . .

the biggest microfiche contract ever — with Encyclopaedia Britannica. The book firm will distribute copies of source materials to libraries on microfiche, packing up to 1000 page images on a 3x5 inch card at reductions to 90x.

Neither Images nor Britannica is saying much, but industry sources peg the value of the contract at around \$5 million. This figure will probably depend on the number of libraries that EB can sell its idea to. For starters, the libraries will be offered a \$15,500 package that will include 20,000 books (on American history up to 1914) on fiche, plus various catalogs and research aids, and fiche viewers.

This much is known about Images Enterprises. Its president is Pat Hines, it has been around for about two and a half years, and was initially formed as a software firm. Although the company itself has managed to keep its existence a near-secret, intentionally or otherwise, many well-known figures sit on its board. Board members include UCLA Chancellor Chas. E. Young, Richard Kramlich, a senior partner in Rock & Assoc, James Ritter, pres. of Transamerica Computer Corp. and once IBM's top financial man, and board chairman William Lendman, ex-chief exec of Blair & Co.

Given the influence and prestige of the book company, and the potential impact of the library program (there are over 5,000 college libraries alone in the U.S., plus city libraries, private libraries, etc.) the contract may signal the beginning of a move toward standardization in the ultramicroform industry. For instance, although the state of the art technology can go well beyond the reductions that will be used on EB's fiche, the 90X figure is thought to be one that most UMF hardware suppliers can handle.

### BARON FORMS NEW FIRM FOR EUROPEAN SERVICE CENTERS

Century Computing Corp. is a new company that has its headquarters in a file drawer in Dallas, but is undertaking an ambitious program of establishing computer service centers in Europe, the Middle East and possibly even behind the Iron Curtain. The brainchild of Arnold Baron, a Dallas oil man now resident in Athens, the company operates a service center with Honeywell equipment in a Frankfurt suburb, has another center with Siemens equipment in Milan, and has plans to open centers in four other German cities.

Backbone of the business currently is hardware/software services tailored to the processing needs of banks. Baron is talking with Yugoslavian officials about prospects for opening a center in that country and reports a strong private industry current in that presumably Communist country. From his base in Athens, Baron also plans to extend operations into the Middle East where there would be a tie-up with his oil background and the rapidly growing computer needs of the Sheiks. The Dallas office exists primarily as a holding company for the foreign operations. Now privately held, Century has been financed largely with European capital which, Baron claims, is less costly than American money and readily available.

### ENGLAND MAKES MISTAKES IN PARALLEL WITH U.S.

Ira S. Gottfried, half of the L.A. based management consultant firm, Norris and Gottfried, recently returned from England with a few observations on the current state of the industry there and the general conclusion that the U.K., instead of profiting by U.S. mistakes, is paralleling them.

He cited England's lack of long-range planning (that's certainly a parallel) and the associated application-by-application conversion. This, said Gottfried, in spite of the fact that the U.K. was fortunate in not having had enough second-generation equipment to necessitate large-scale conversion. Generally, their use of hardware is efficient because of this.

Perhaps the U.K.'s largest parallel difficulty, Gottfried said, is the lack of top management involvement in computer operations. This has led to "tremendous frustration" on the part of systems people, "who have to design in a vacuum." This, and the fact that computer specialists, even though they occupy the second highest job level in the Kingdom but make only about half the U.S. salary for comparable positions, will cause a greater brain drain in the near future than ever before, Gottfried predicted.

He also noted that British firms keep computer people too low in the organizational pecking order, a practice that the U.S. has only recently begun to abandon. He said that if top management can't or won't learn about automation and what to do with it, it is inevitable that computer people will become top management.

On the plus side, Gottfried stated that the British are much more conscious of the total cost of systems (they know where the money goes), and their installations are simpler, although they're making no more progress at being able to measure produc-

tivity than the U.S. The government is now subsidizing training of computer personnel by funding corporations directly for this purpose, thus providing, it would seem, more brains to be drained.

The industry environment in England differs considerably from that in the U.S., Gottfried said. They are "extremely conscious of proprietary rights," there is no raiding of competing firms for personnel, and there is little fraternization among members of the computing community, with a resultant minimal exchange of information. These last conditions are beginning to improve, Gottfried noted.

He said that two years ago he considered the British five to seven years behind the U.S., but that now he thinks they've narrowed the gap to three to five years and it's steadily diminishing. He noted the imminent switchover of British currency to the decimal system and the considerable amount of reprogramming that will be necessary.

"They want to change in other ways, too," Gottfried said. "They'd like to switch to driving on the right-hand side of the street, but they have all those thousands of buses with doors on the left-hand side."

### CRT'S TO EASE AIRLINE BOARDING CRUSH

As the airlines nervously await the arrival of jumbo jets that may turn airports into chaotic scenes resembling subway stations, Eastern Airlines is attempting to alleviate the crush at boarding time by the use of a Raytheon-developed crt-computer system at Kennedy Airport. Agents manning Digital Information Display Systems DIDS-400 crt/keyboard terminals will be able to issue boarding passes in a swift operation: An arriving passenger will check his bags, then report to one of five check-in counters; there he submits his ticket and receives a boarding pass on which is printed-out his flight number, class of service, date, gate, seat number, and destination. As each passenger arrives, an agent interrogates the system through the keyboard; the crt then displays the seat layout of any desired flight and indicates seats previously reserved. The customer selects his seat from those remaining and the terminal prints the boarding card and updates seat availability.

The new system eliminates the old two-stop procedure of checking in at the terminal counter after carrying luggage through the lobby and checking in again at the boarding gate. Now, with the one-step procedure, passengers are free to roam or wait





## ROTOMARK® data input in 1/4 second

The optical scanner of Rotomark EDP Systems collects as many as 18 digits in 1/4 second. The scanner reads circular markings from Rotomark labels, which are created on a Rotomark printer. The scanner is centered on the label, the optical scan is automatically triggered, and a light on the scanner indicates completion. Accuracy is 100%. No formal employee training is required for operation, and actual data collection is about 25 times faster than manually keying-in.

One application of Rotomark EDP Systems is order entry. The label markings represent stock number, price, or other data of your choice. As reorder stock is needed, labels attached to shelf moldings below each item are scanned. Data passes through the Rotomark controller and is instantly recorded on magnetic tape. After all orders are

recorded, the taped information is transmitted by telephone line to a computer at a central warehouse.

For industry and retail operations, Rotomark EDP Systems offer accuracy, convenience, speed. Hardware available now. *Learn more by mailing the coupon below today!*

Monarch Marking Systems, Dayton, Ohio 45401  
REQUEST FOR FURTHER INFORMATION

Please send brochure on Rotomark Systems  
 Please have a representative call

NAME \_\_\_\_\_  
TITLE \_\_\_\_\_  
COMPANY \_\_\_\_\_  
STREET \_\_\_\_\_  
CITY \_\_\_\_\_ STATE \_\_\_\_\_ ZIP \_\_\_\_\_



**MONARCH  
MARKING SYSTEMS**

DAYTON, OHIO 45401 • PHONE 513-866-7401

A Subsidiary of Pitney-Bowes





# in tape systems...

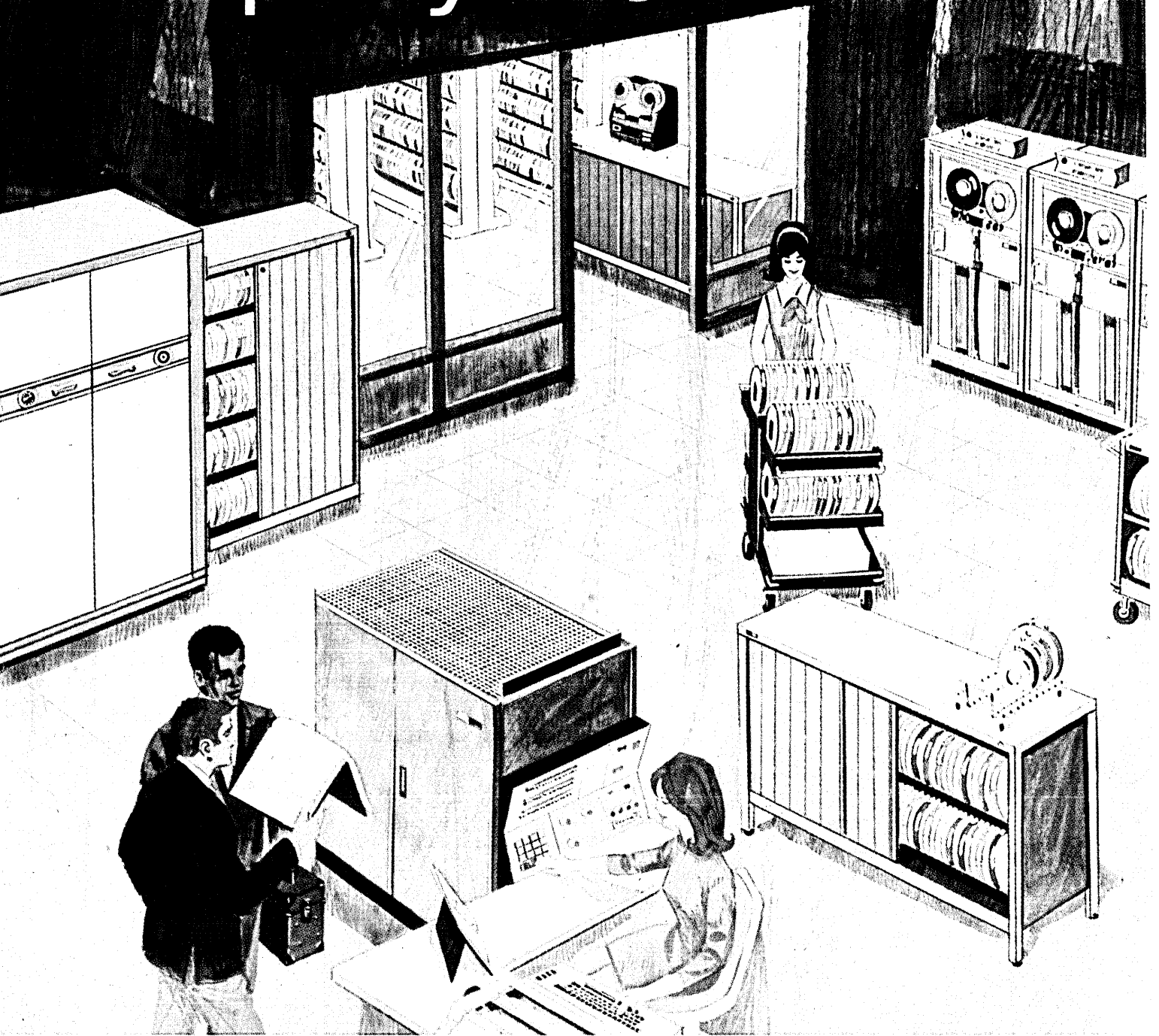

## Wright Line Accessories Complete the Picture

In any data processing installation the computer is only part of the picture. Wright Line completes the picture by adding the essential storage and handling accessories that speed throughput and protect vital EDP media.

For complete information on Wright Line accessories for tape systems, circle the reader's service number or contact any of Wright Line's more than 80 offices throughout the U. S. and Canada.

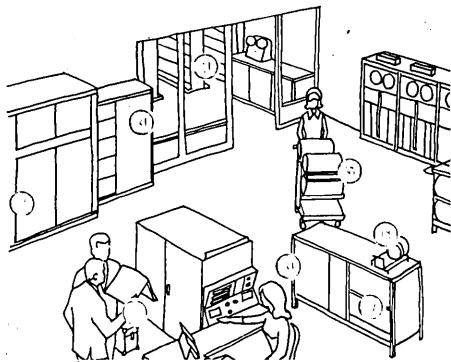

1. Data-Bank Safe for the protection of Magnetic Media
2. Tape-Seal Belts in 8 colors
3. Tape Cabinets
4. Library Storage units
5. Tape Trucks
6. Racks
7. Binders and Carrying Cases



160 GOLD STAR BOULEVARD, WORCESTER, MASSACHUSETTS, 01606  
A DIVISION OF BARRY WRIGHT CORPORATION

CIRCLE 107 ON READER CARD

## news briefs . . .

anywhere in the terminal. And the key is to spread out the crowd of waiting passengers. Thus, even if the waiting areas cannot be expanded in time for the arrival of the giant jets, perhaps the additional passengers can be accommodated by spreading them out in the terminal, allowing them to occupy whatever space is available.

The system has been in operation since December, and is being leased from Raytheon on a one-year basis, with an option to purchase should Eastern feel the system is satisfactory. A 16K Raytheon 703 computer is dedicated to the system, which also includes two additional terminals at the main ticket counter and one at the entrance to each of the two main boarding concourses. The exact cost of the system was not revealed, but is reported as being about \$5-10K per terminal.

### new companies . . .

Everyone seems to want to get into computer services, act or not. Undeterred by threatened passage of the Congressional bill that would curtail banks from offering data processing to outside clients, First Union, Inc., a holding company for a bank and trust in St. Louis, has gone ahead and established **First-Union Automation Services, Inc.**, offering I/O processing services, including COM. It will utilize the bank's three IBM/360 systems to help "subsidiaries . . . and other computer users." So far there aren't any subsidiaries except the service company itself . . . Southern Pacific railroad has formed a subsidiary, **Tops On-Line Service, Inc.**, to originate and operate real-time data collection and information systems, particularly for transportation and distribution firms, where it can apply its particular type of expertise (December, p. 246). It will be based in San Francisco . . . A nationwide vehicle leasing and automotive service company, Paragon National Corp., has formed **Paragon Computer Services, Inc.**, to service its parent company and outside customers, and will compile an information bank for instant lease pricing to the customer through a time-sharing system . . . A dp firm that plans to provide a national unified computer accounting system for U.S. credit unions has incorporated in Madison, Wis., as **Cunadata Corp.** . . . It is sponsored by CUNA International (formerly Credit Union National Association), state credit union leagues and other credit union organizations . . . Information systems and related management aids

will be furnished by **National Management Service, Inc.**, L.A., as a subsidiary of National General Corp., serving that conglomerate's companies, as well as other companies in the leisure time and financial fields . . .

**United Business Communications, Inc.**, will supply data communications systems to users of parent United Utilities, Inc.'s telephone system, for lease or purchase, from hq in Kansas City. UUI in December purchased part of GDI, Inc., Florida peripherals manufacturer, and already has an interest in Rixon Electronics, Inc. . . . **Computer Software Corp.** has been formed in Minneapolis by three former employees in exodus from EMR-Computer, a Schlumberger facility. The new company will specialize in seismic dp, like the company that got left . . . Likewise, three other key executives from Computing & Software, Inc., have resigned to form **Proprietary Computer Services** over the hill in San Fernando Valley. President is Bill Barancik, former vp at c & s. Besides processing original software programs, the firm will do systems analysis and facility management . . .

**Information Systems Development, Inc.**, recently formed Kansas City company, will develop and evaluate management systems, particularly in urban planning and transportation . . . Philadelphia-based **Datafile Systems Corp.** will furnish on-line information to the wholesale distribution industry. It was formed by Mechanical Technology, Inc., and partially financed by a GE subsidiary. It will be piloted by Francis A. Rowe, former gm for Univac's info services division . . . **Honeywell, Inc.**, has reorganized its dp activities into three new divisions: Data Products at its San Diego plant; Data Systems, serving the federal government and specialized commercial areas, and Tampa, which will go on making digital communications equipment . . . **Decision Data Corp.**, at Warminster, Pa., outside Philly, will design, manufacture and market a line of peripherals, subsystems and auxiliary equipment. It is being run by ex-Univac management personnel . . . **Tally Data Services**, Kent, Washington, will give customers a choice of their own computer programs and personnel or having everything handled separately, but in either case all work will be done in one building, where office and parking space will be available to companies who want to preserve their own staffs. Tally calls it a "drive-in" service . . . Change-of-name-for-the-month:

Computer Equipment Corp. has become **Electic Computer Corp.** "to better reflect the business of the company." It is a Dallas-based peripherals supplier with facilities in Houston, Phila-

delphia and New Orleans . . . Then there is **Pegasus Data Sciences**, formed to operate and market computer study aids at centers to open in the San Francisco Bay area and central California . . . Another name-change in Miami: Computer Controls Corp. to **Control Industries Corp.** . . . **Computers Unlimited, Inc.**, is the optimistic name of a company that has opened a computer center in Rochester, N.Y. . . . The push in medical systems continues, as **Physiodata, Inc.**, Montclair, N.J., has created a **Datmedic Systems Div.** to program and process data on patients that can enable doctors and hospitals to diagnose their illnesses . . . **Computerized Health Systems & Services, Inc.** has been organized in Norman, Okla., to provide services and supplies to nursing homes . . . **Medical Information Technology, Inc.**, will offer programs for automated patient interviewing, clinical lab reporting and hospital census operations. The programs are designed not to upset the customer's biomedical routines . . . **Computer Software Analysts, Inc.**, in L.A. is in the business of analyzing software for quality and performance, on a consulting or periodic checkup basis . . . No sooner was **Computer Development Corp.** organized in Dallas than it moved to Santa Ana, Calif., "to take advantage of the availability of top-flight computer-oriented personnel at both the executive and technical level." **Information Transfer Corp.**, Santa Monica, Calif., will produce and market information products and systems, beginning with resources investment and management, and continuing education and training.

### mergers, acquisitions . . .

Looking for new worlds to conquer, **Allied Management & Systems Corp.**, Chicago computerized consultant firm, has gone southside into one of that city's most celebrated industries and bought the **South Chicago Packing Co.**, beef and edible oils supplier. Data will be processed along with the beef at the packing house's "profit center," which has developed a special software program for the meat packers, called STOMP . . . In Dallas, **Computer & Systems Resource Management, Inc.**, has agreed to merge into **Crown Reserve Mines, Inc.**, a Salt Lake City mining exploration company that has proposed in return to change its name to **Computer Systems Management, Inc.** Mining exploration will continue, but the accent will be on facilities management . . . **Boothe Computer Investment Corp.** has disclosed equity investments in 11, count 'em, companies: **Peripheral Technology, Inc.**, Sunnyvale; **Computer**

## news briefs...

Power Systems, Inc., Sunnyvale; Dynamic/LeasaMetric, Inc., Burlingame; Vector General, Inc., Canoga Park; Micrex Corp., Santa Clara; Typagraph Corp., San Diego; Computer Financial, L.A.; Western Operations, San Francisco; Peripheral Equipment Corp., Chatsworth; Information Magnetics, Santa Barbara, and Courier Terminal Systems, Inc., Phoenix (the only non-California firm) ... Comress, Inc., Rockville, Md., has an 80% interest in Complex Systems, Inc., N.Y.C. teleprocessing computer system developer ... KDI Corp., another acquisitions-minded organization, has one more, RF Interonics, Inc., Bayshore, Long Island, electronic components manufacturer for computers ... EDP Technology, Inc., the Washington, D.C. systems development firm, has used some of its stock to buy Computer Systems & Software, Inc., a similarly oriented Orlando, Fla., company that is marketing a minicomputer system with supporting software for small businesses ... A nationwide computer utility is the goal in a merger between Optimum Systems, Inc., Palo Alto, and U.S. Time-Sharing, Inc., Reston, Va. They offer remote and multi-access computing services, also design and install information systems ... Dial-Data, Inc., Newton, Mass., is merging into Tymshare, Inc., Palo Alto t-s firm. D-D, also in t-s, has offices in Boston, N.Y.C., and Washington, D.C. ... Berdj C. Kalustyan, formerly an executive with Ultronic Systems, and founder/president of another diversified company, has bought controlling interest in Digital Data Systems Corp. and reorganized its management and financing. The Pennsauken, N.J., firm produces the Creditmaster retail card verifier system for instant-checking fraud and bad debts in retail stores ... Automatic Data Processing, Inc., Clifton, N.J., is acquiring two companies, Chicago-based Electronic Data Service, Inc., and MSM Computer Service, a financial portfolio analysis-by-computer firm in N.Y.C. ... Resource Financial Corp. in Los Angeles has agreed to merge with Aries Midwest Corp., of Chicago and Minneapolis, to offer a full range of computerized real estate financial services to both the real estate industry and the public. The combined company will operate under the L.A. name ... Growth Industry Computing, Inc., L.A.-based computerized market research firm, has acquired Comps, Inc., marketing data publisher in the same area, and proprietor of a large real estate transaction data base

... Also in L.A., computerized servicing of mortgages will be added to the capabilities of Computing and Software, Inc. with acquisition of Mortgage Associates, Inc., a Milwaukee firm ... In Bala-Cynwyd (Bah-la Kin-Wid), Pa., Computer Sharing, Inc., has agreed in principle to merge with Data Network Corp., N.Y.C., to pool their time-sharing facilities and services. CSI is a subsidiary of Scientific Resources Corp. ... In the ever-active biomedical field, Medical Computer Systems, Inc., Dallas, has agreed to acquire American Medical Computer Center, Inc., a Chicago subsidiary of American Biomedical Corp., claiming this will make it the nation's largest hospital computer system. American Biomedical will continue to own and develop its MANAGE system for hospital and clinic application ... Hospital Corporation of America has agreed to acquire Real Time Computer Systems, Inc., both in Nashville, Tenn. HCA has 23 facilities, with 10 more under construction and an additional 10 in the development stage ... And American Medicorp, Inc., (it's in Bala Cynwyd, too) has agreed to acquire Beehive Electrotech, Inc., Salt Lake City manufacturer of electronic equipment used with computers, particularly patient monitoring devices with memory and processing capabilities ... More dispositions than acquisitions: Datatab, Inc., has sold its computer letter subsidiary — it operated at a loss last year — to American Computer Resources, Inc., in L.A. ... Also in L.A., Sterling Computer Systems, Inc., has sold Computer Systems Services, Inc. back to its previous owners only four months after buying it. CSSI contributed less than 1 cent per share to Sterling earnings ... United Data Centers, Inc., has sold Computech, Inc. to International Systems Associates, Ltd., all in New York, in accordance with UDCI's "policy of concentrating its marketing efforts in secondary and tertiary cities in the United States".

● The great sprawl of last fall's Joint Computer Conference in Las Vegas was probably the record — in future, exhibitors will be held to 1,000 booths (the usual 10' X 10'), according to an announcement from AFIPS President Dr. Richard I. Tanaka. Requests for more than 1200 booths already have been made for the Spring Joint, but AFIPS has recognized that "it must maintain the high quality of the exhibit program and ... assure that the exhibition does not escalate to a prohibitive size." Booths will be allotted on the same basis as before, taking into account main line exhibitors, moving displays, number of times

previously exhibited, etc. AFIPS also is upping its registration ante from \$30 to \$40, but sweetening the raise by making \$10 of it applicable toward membership in any one of the AFIPS societies.

● The training of IBM's customer engineers at some 200 branches will be simplified by a computerized enrollment and scheduling system called CAE (Computer Assisted Enrollment), developed by that company's Field Engineering Division. Course sequences will be individually scheduled by computer for each customer engineer. More than 600 education courses are involved. Training requests will go by remote terminals to a central computer in Poughkeepsie, N. Y. Training records can also be examined, and schedules rigged 12 months ahead.

● Master Charge merchants in Ohio, about 30,000 of them, can get a transaction authorized in less than 25 seconds by calling a toll-free number that is linked directly to the BancSystems computer center in Cleveland. (BancSystems is an association of Ohio banks organized to support the Master Charge credit card system.) Incoming calls are intercepted by a special telephone operator who asks for the card number and purchase amount, which is typed directly into the computer, an IBM 360/67 linked to an audio response system. At the same time, the sale is recorded against the proper account. If there is some question, the computer switches the call to a control center for the bank that issued the card. The operator asks for a display of that customer's entire credit listing with Master Charge and then approves or rejects the credit request. If the card has been stolen, the operator may ask the storekeeper to confiscate it and detain the suspect, probably depending on how big he is. Future plans call for the merchants to be able to dial directly into the computer. Regional and national expansion of the system is expected.

● Europe's largest real-time computer system, Scandanavian Airlines System's SASCO II reservations and management information system, has been inaugurated in Copenhagen. It is centered around three 131K-word Univac 494 computers — one for real-time applications, the second for back-up and test purposes, and the third primarily for batch processing. Peripheral equipment includes six FASTRAND II mass storage units, 16 FH-432 and three FH-1782 drums,

and 28 mag tape units. SAS also has seven Univac 418-II computers that are used to control traffic between some 500 remote terminals installed in sales offices and as a message switching system linking Denmark, Norway, and Sweden. SASCO II can handle an average of 150,000 automatic data transactions per day. In addition to handling passenger seat reservations, the system takes care of traffic programs, crew control, aircraft maintenance, material supplies, meal services, and the company's entire accounting and revenue controls. Remote load control is also done on-line. An automatic cargo handling system scheduled for next year will include on-line input of air way bills, storage and location data, production of tallies and interrogation facilities.

- Honeywell Inc. has recruited Dr. Ugo O. Gagliardi, a computer scientist who has served in government and educational facilities (the Air Force, Harvard) and been in research since 1954, to head its new Information Sciences Center at Cambridge, Mass. The center will conduct basic research in advanced computer systems, and will explore new ideas in mainframes, peripherals, operating systems and languages. Dr. Gagliardi comes from Interactive Sciences Corp. in Braintree, Mass., where he was vice president and technical director.

- The story on Dr. James E. Storer is that he resigned as director of Sylvania's Applied Research Laboratory to avoid presiding over its dissolution. Sylvania's decision to discontinue the laboratory as a separate entity and distribute its parts among various affected divisions probably will take six months to implement, but Dr. Storer submitted his resignation as soon as he heard of Sylvania's intentions, and announced he will henceforth be a private consultant, his only connection with the laboratory possibly being some consultant work to complete unfinished projects. Sylvania maintained that closer relations between research and the division involved would make for better coordination and results, and said it was following Government recommendations.

- Honeywell's Communications and Data Products Div. has spawned three new divisions: The Data Systems Div., to be based in Minneapolis, will market and install all Honeywell computer products to the U.S. government and will design and develop specialized commercial systems. The

Data Products Div., based in San Diego, designs and produces Keytape units and disc packs and markets printer ribbons and magnetic tape. The Tampa Div., which is a producer of digital electronics equipment, plans to expand into commercial markets. The new divisions will join four others in the Computer and Communications Group.

### shortlines . . .

Come spring, headquarters staff from IBM's new General Systems Division will move from White Plains to Atlanta, chosen for "its advantages as a business, cultural and educational center." General Systems is one of the six divisions of IBM's Data Processing Group, and was created to concentrate on low-cost equipment. Its labs and manufacturing plants are in Rochester, Minn. and Boca Raton, Fla. . . . National Cash Register has elected to keep Dayton as hq for its network of nationwide service centers (currently in seven major urban areas), but is putting up a new building to house the staff. Construction plans include a computer center with eight NCR systems. The facility should be ready in time for spring occupancy. . . . Spring will also see a dp center installed in Singapore by Digicon, Inc., Houston-based geophysical firm, which is concentrating its exploratory operations on Southeast Asia — oil drilling activity there doubled in 1969. The center, expected to be operable by April, will use an XDS 9300 computer, with a 15-man staff of geophysicists, programmers and computer operators. . . . Rental and service prices on Mohawk Data Sciences equipment have been raised about 3% effective May 1, on about 30 models. Income from rental and service amounts to some 30% of Mohawk's total revenue. Increases range from a basic \$3.50 to \$42.50 per month. . . . A miniature, low-cost computer, using LSI/MOS techniques, has been developed by Bunker-Ramo Corp. and delivered to the Air Force Avionics Lab. It weighs less than eight pounds, is 270 cubic inches. The Air Force plans to use it in air-to-surface missiles and other tight-squeeze applications. . . . Carterfone has a new, completely transistorized mobile telephone unit that may be tied directly to the public telephone network or to radio common carriers that tie in to the network. Users who plan to have a unit for more than just a few months can get it for substantial savings, and its workmanship and parts are guaranteed for a year. It operates on all VHF telephone channels, and can be used with marine radio telephone frequencies. And if the driver is away from the automo-

bile when a call comes, it will honk the horn to get him back. . . . The worldwide Automatic Voice Network, AUTOVON, is progressing: switching centers have opened at Martlesham Heath, England; Donnersberg and Shoenfeld, Germany; Humosa, Spain; and in the Pacific at Dau (Philippine Islands) and Guam. There are still 45 centers to go; they are being installed by Automatic Electric Co., a subsidiary of General Telephone, for the Department of Defense, to give voice and data communications to the armed services, wherever.

### call for papers . . .

**Western Electronic Show and Convention (WESCON)**, Los Angeles, August 25-28. Sponsored by WEMA and IEEE Region 6. Letters are solicited proposing agenda for sessions, including topic, scope it would cover, and speakers for each of four papers within the session. Subjects include components and circuitry, automation of electronic assembly, computers, edp and software, communications. Letters should be sent by March 15 to Ernest W. Pappenfus, Technical Program Chairman, WESCON, 3600 Wilshire Blvd., Los Angeles 90005.

**Fifth Annual Symposium, Application of Computers to the Problems of Urban Society**, New York City, August 31. Sponsored by the New York metropolitan chapters of the ACM; to be held adjacent to the ACM National Conference and Exposition, September 1-3. Computer applications and experiments in urban information systems and planning, operations research, architecture, pollution, housing, transportation, welfare problems and education will be the subjects under discussion. Also, directional trends in these areas will be explored and reviewed. Entire papers, in five copies, must be submitted by April 15 to Paul R. DeCicco, ACM Urban Symposium Chairman, Polytechnic Institute of Brooklyn, 333 Jay St., New York, N. Y. 11201. All accepted papers will be published in the symposium proceedings.

**Systems Science and Cybernetic Conference**, Pittsburgh October 14-16. Sponsored by IEEE Systems Science and Cybernetics Group. The theme, "Systems for the Seventies" will be expanded on by sessions devoted to artificial intelligence, cybernetics, biomedical, learning and teaching, information, and urban and public systems. Abstracts of about 1,000 words should be submitted to Prof. A. Lavi, Carnegie-Mellon University, Pittsburgh 15213, by April 15. Final manuscripts will be due August 15. ■

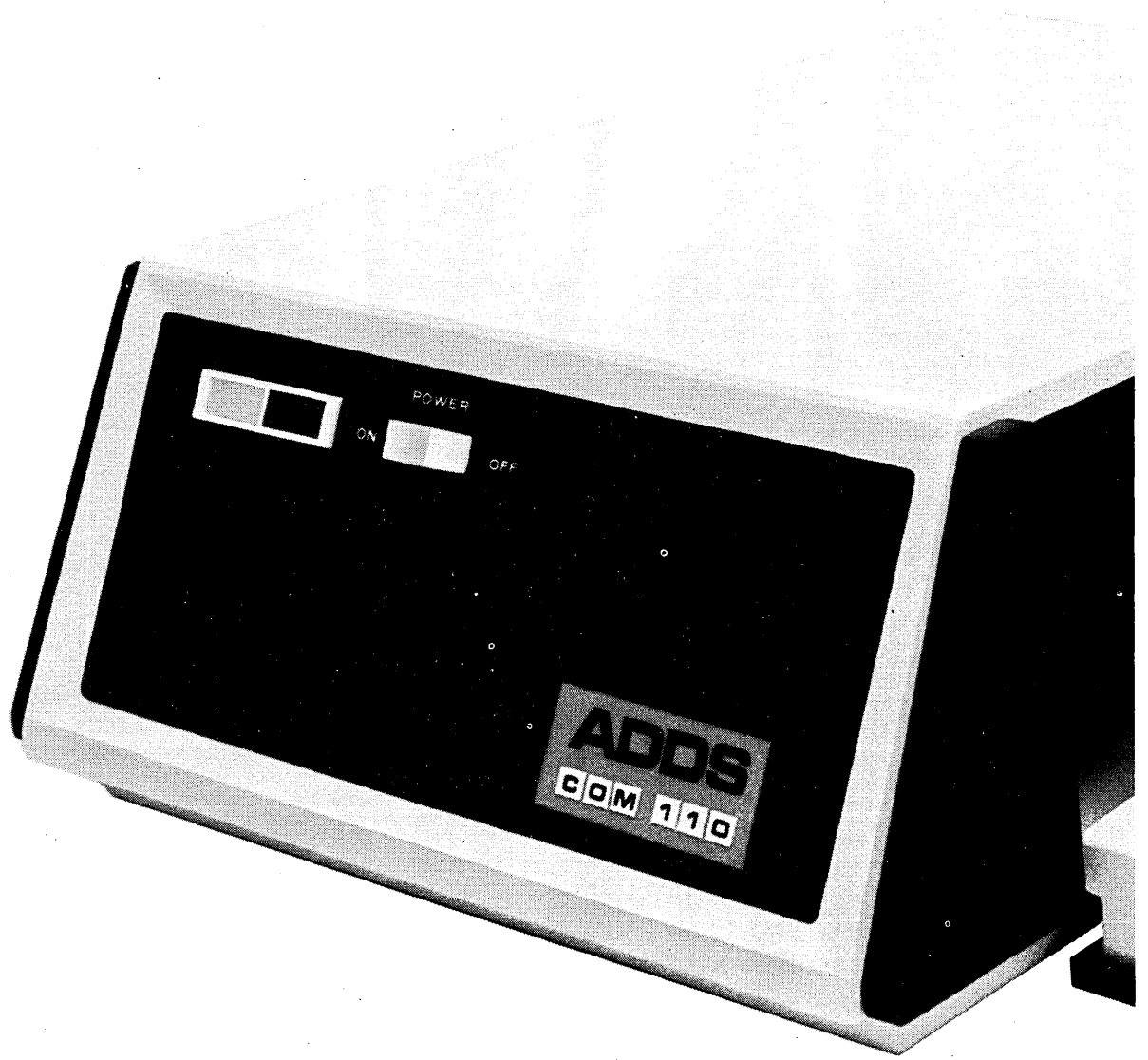

# Data survival kit



This new acoustic coupler delivers data alive and well over lines noisier and 10 times weaker than other couplers can tolerate.

We've found a way to virtually eliminate a problem that has been plaguing acoustic couplers for years—second harmonic distortion.

This means you no longer have to worry about the transmit signal generating interference with the receive signal. We've all but cancelled that problem by adding a signal component that offsets distortion, bringing harmony to data transmission.

As a result, we can transmit at higher power than other couplers. And we can receive much weaker signals than other couplers.

One or two other things. Normally, a computer has no way to verify the accuracy of its transmission to a remote teletype. With our remote echo option, the coupler will send received data back to the computer for verification. This option operates under direct computer control. If there is an error, the computer will let you know. Also, with our parallel input/output option, the interface between our acoustic coupler and your equipment may be parallel, rather than our standard TTY or EIA serial data interfaces.

In short, there is no longer any reason for your data not to survive. Perish the thought.

Another innovation from the company that specializes in data communications systems.

**ADDS**  
Applied Digital Data Systems, Inc.

Patents pending

Mr. Richard Kaufman, Dept. 23  
Applied Digital Data Systems, Inc.  
89 Marcus Boulevard  
Hauppauge, New York 11787

Please send more information.

Name \_\_\_\_\_

Title \_\_\_\_\_

Company \_\_\_\_\_

Address \_\_\_\_\_

City \_\_\_\_\_ State \_\_\_\_\_ Zip \_\_\_\_\_





# system spotlight

information for  
this series is invited  
applications submitted must  
be installed and operational

## HIGH ACCURACY TELESCOPE

U.S. Naval Observatory, Washington, D.C.

Ancient mariners sighted on the stars to calculate a ship's north-south position or latitude. The determination of east-west position, or longitude, was much more difficult for them and was not accurately done before the invention of good timepieces. (The timepieces were required since the stars which are over any position on Earth, except the poles, change from hour to hour.) Our Earth time, in turn, is directly related to the position of known stars in the sky, and so both precise navigation and precise time-keeping rely on being able to measure, to a very high degree of accuracy, when a familiar star passes over a fixed point on the Earth.

A transit circle, like the Navy's six-inch telescope in Washington, D.C., is made for observing stars passing over a known north-south line, or meridian. These telescopes, also called meridian circles, have only one axis of rotation—they can sight only along the meridian that passes directly over them. Their angle of rotation along this axis is measured from the celestial equator and can be very accurately determined. In the case of the Navy's transit circle, this measurement is known to within 0.2 seconds of arc.

### computer and peripherals

IBM 1800 with 8K (16-bit) words of core storage; 4 usec cycle time  
One 1810 dual disc drive  
One 1442 card reader/punch  
One Inductosyn angular position determining system  
plus two typewriter keyboards, a 10-digit keyboard, clocks, analog/digital converters, stepping motors, a thermometer, barometer, and humidity indicator, etc.

### application

The observer brings the telescope into position to watch a certain star, then enters the star number on the 10-digit keyboard. The 1800 pulls from

disc a 16-bit number to set the angular position detection system to within about one minute of the true setting of the telescope. This position measuring system, called an Inductosyn and designed by the Farrand Optical Co., has a 16-bit input buffer, several switch closures, timing sequence logic, and a 25-bit output buffer. Once its counting cycle is initiated by the 1800, an error signal representing the difference between the 16-bit approximate position of the telescope and the actual position as measured by the Inductosyn is brought to zero. The 1800 then reads the full 25-bit buffer of the Inductosyn, which contains the position of the telescope to an accuracy of 0.038 seconds of arc.

As the star moves across the field of the telescope, the observer measures its position with a pair of micrometers and signals the 1800 to record the measurements. Along with these figures the value of the sidereal (star) time, which is stored in an internal counter and updated by an external interrupt each second, is recorded to

an accuracy of one millisecond. The Inductosyn, thermometer, and other external devices are sampled to give the conditions of the observation, and the data is stored on the disc along with identifying and editing codes. The disc file is edited and the data is punched out onto cards, usually the following morning, for processing on an IBM 360/40.

### hardware

The 1800 recognizes three levels of external interrupt—from the telescope, the observer, and the clock. The interrupts from the telescope are mostly used to indicate error conditions. For example, the telescope axis must remain in position to within 0.005 inches during an observation. If this amount is exceeded, an interrupt causes an error message to print out.

The observer can communicate with the computer through a set of buttons that he holds in his hand. Using these he can cause particular registers to be read, and three different tones are used by the computer to indicate to

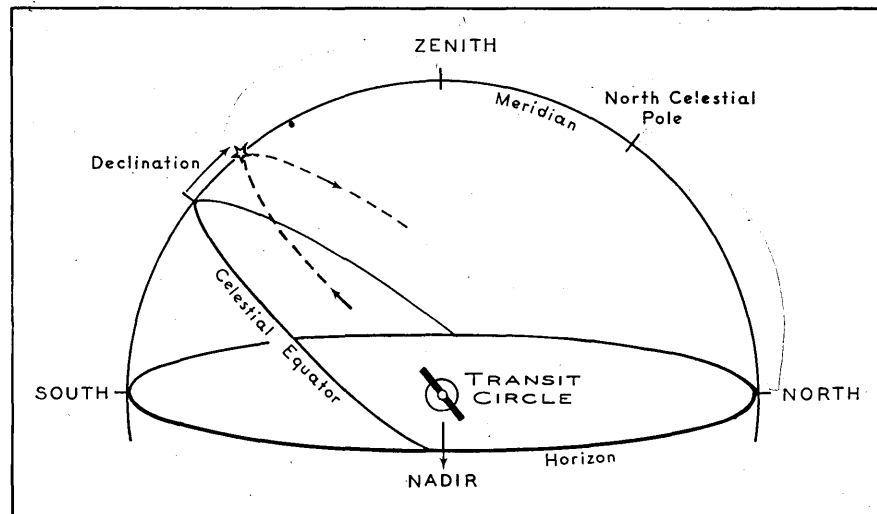

The coordinates on the sky corresponding to latitude and longitude on the Earth are called declination and right ascension. The meridian is the north-south line passing directly overhead. Sidereal time is the right ascension of an object crossing the meridian, and the crossing is called a transit.

the observer that the data has been successfully recorded.

Four 16-bit output registers provide data and switch closure commands to the telescope and Inductosyn. For example, the motor on the right ascension micrometer, the device which is used to locate the star from right to left in the field of vision, must be driven at a rate varying with the cosine of the declination (north to south position) of the star. This is done by means of a stepping motor controlled by the 1800.

The end result of an observation of a single star is an absolute position of that star with a probable error of around 0.2 seconds of arc. On a clear winter night 250 to 300 stars can be observed at a rate of about one every two minutes. The present study calls for from four to 20 observations to be made of about 10,000 stars. These observations are then to be combined to form a star catalog to be used in the determination of time, in navigation, and as the basic reference for all other astronomical work.

Sixteen 16-bit input registers accept data and switch closures from various sources. These include the two micrometers that are used to measure the right ascension and declination. The output of a micrometer is an analog signal, however, which must first be converted and buffered. Slow speed devices, including the electronic thermometer, barometer, and humidity indicator, are connected to encoders and read in Grey code.

Thus for each observation, the following are recorded: the star number, six readings of the right ascension with the associated readings of the sidereal clock, four readings of the declination with the associated right ascension readings, four readings of the Inductosyn, the mean of the four Inductosyn readings, the temperature, pressure, and dew point.

#### software

A single program called *scon* han-

dles the entire operation, including the disc editing and punching to cards. Written in 1800 assembly language, the program would take up 1100 words, but three sections (routines for initializing the system, handling most of the typewriter I/O, editing and punching) are written as overlays.

All of the messages printed fall into four categories. *REQUEST* messages are called by the observer to allow him to enter information, such as his personal code letter. *INSTRUCTION* messages tell him to perform some operation. *ERROR* messages inform him of malfunctions of the equipment, such as a loss of signal on the input lines, or of incorrect observing procedures such as entering the wrong star number, or of computer difficulties such as disc overflow. Finally, *STATUS* messages inform the observer of actions being taken by

the system, such as dumping the data onto cards. The *ERROR* and *INSTRUCTION* messages also turn on a warning signal, which must be turned off from the typewriter.

A specialized operating system (*SIROS*) was written for the 1800 so that important interrupts, such as clock updates, can be serviced even when the machine is being used in the off-line mode processing utility programs.

This semi-automated installation has been in operation over six months and has demonstrated several significant advantages over its manual predecessor, such as real time malfunction detection and error correction. One of its biggest contributions has been to prove the feasibility and desirability of completely automated transit circles, the first of which is now under development. ■

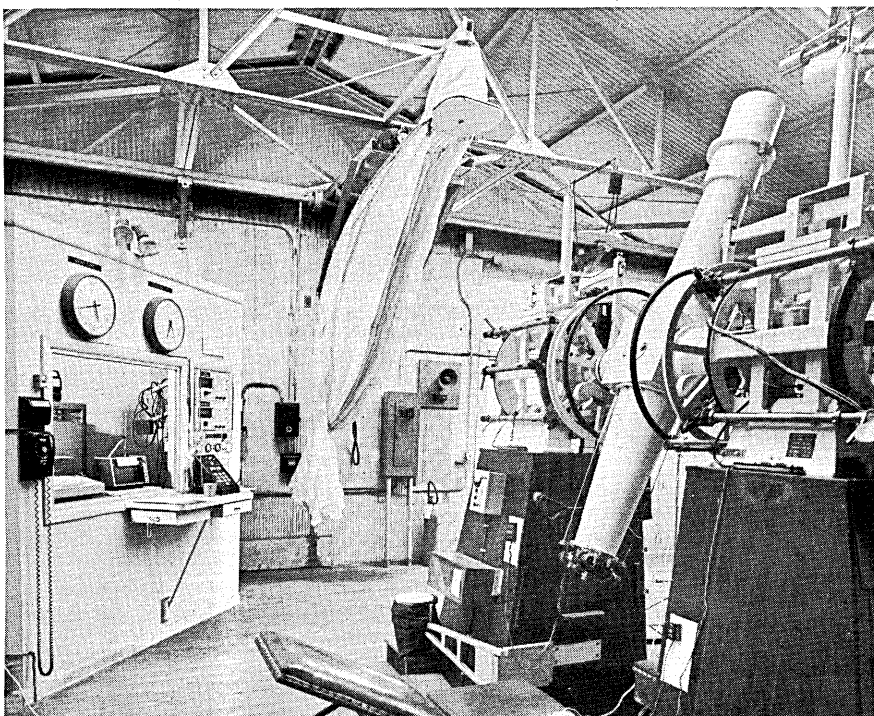

OFFICIAL U.S. NAVY PHOTOGRAPH

The six-inch transit circle at the U.S. Naval Observatory.

# Stop Computer Errors!

Data Processing errors are often caused by line voltage fluctuations. No more wasting costly computer time hunting for data and program errors or nonexistent equipment problems. The DRC Voltage Transient Monitor continuously monitors power lines for these costly fluctuations . . . sounding a warning when one occurs, and permanently recording the amplitude, duration and time of occurrence.

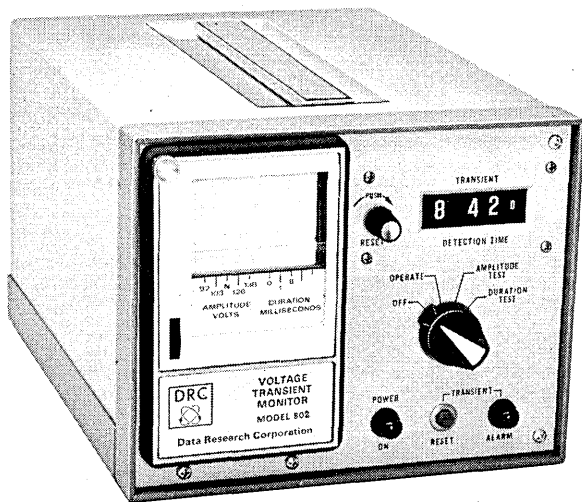

**Complete system sells for \$870**  
**Leases for \$23.40 / month**

DATA RESEARCH CORP. 2601 EAST OAKLAND PARK BLVD.  
 FORT LAUDERDALE, FLORIDA 33306 • PHONE (305) 563-4206



**DATA RESEARCH CORPORATION**  
 2601 EAST OAKLAND PARK BLVD.  
 FORT LAUDERDALE, FLORIDA 33306  
 PHONE (305) 563-4206

Please send me more information about Model 802 VTM

I am interested in a demonstration. **D**

NAME \_\_\_\_\_ TITLE \_\_\_\_\_

COMPANY \_\_\_\_\_ PHONE \_\_\_\_\_

ADDRESS \_\_\_\_\_

CITY \_\_\_\_\_ STATE \_\_\_\_\_ ZIP \_\_\_\_\_

CIRCLE 119 ON READER CARD



*Courier*  
**the Leader in Terminals  
 and Terminal Systems Design**

There is more to our Executerm Terminals than styling. Each is human-engineered for functional ease in operation, for reliability and for maximum use. Modular construction and circuitry reduce service time to an absolute minimum.

Each is designed for use in a complete remote terminal system of any size or as a single terminal station. Whether you have one office or a hundred and regardless of their geographic locations, Courier will design a complete system to meet the needs of your organization.

For further details on the operation, applications and installation plans, write or phone our Marketing Department.



*Courier*  
**Terminal Systems, Inc.**

2202 E. University Dr./Phoenix, Arizona 85034/Phone: (602) 258-7271

NATIONWIDE INSTALLATION AND SERVICE BY RCA SERVICE CO.

CIRCLE 145 ON READER CARD

# Home-Study Introduction to **FORTRAN** for Engineers Scientists Technical Management

## Why the need to understand FORTRAN?

Certainly not to become a programmer—this would be a dilution of your skill. This American Technological Institute course is designed to facilitate interface between you and the technicians who produce results for you from computers — the men who translate your ideas and needs into FORTRAN. The course is invaluable for an understanding of the FORTRAN language. You will convey your ideas to programmers more accurately; evaluate proposals of systems analysts better; and communicate with these people easily. The man with those abilities is more valuable to any organization.

## Easy and time-saving

A personalized home-study schedule is arranged to suit your convenience—you proceed at your own rate of progress. Upon completion of the twelve-lesson course, you will be thoroughly familiar with the uses and capabilities of FORTRAN.

## Send for Free Brochure

It contains full details, including costs. There is no obligation and no representative will call.

American Technological Institute  
Division of F. D. Thompson Publications, Inc.  
35 Mason Street, Greenwich, Conn. 06830

Please send me your free FORTRAN brochure by return mail.

Name .....

Address .....

City ..... State ..... Zip .....

## American Technological Institute — a task force of experts

ATI is an accredited member of the National Home Study Council. It was organized by the publishers of "Data-mation," foremost magazine in the computer field. It is directed by a P.E.-author and a Doctor of Education-administrator, and guided by a board of college deans, engineers and EDP scientists.

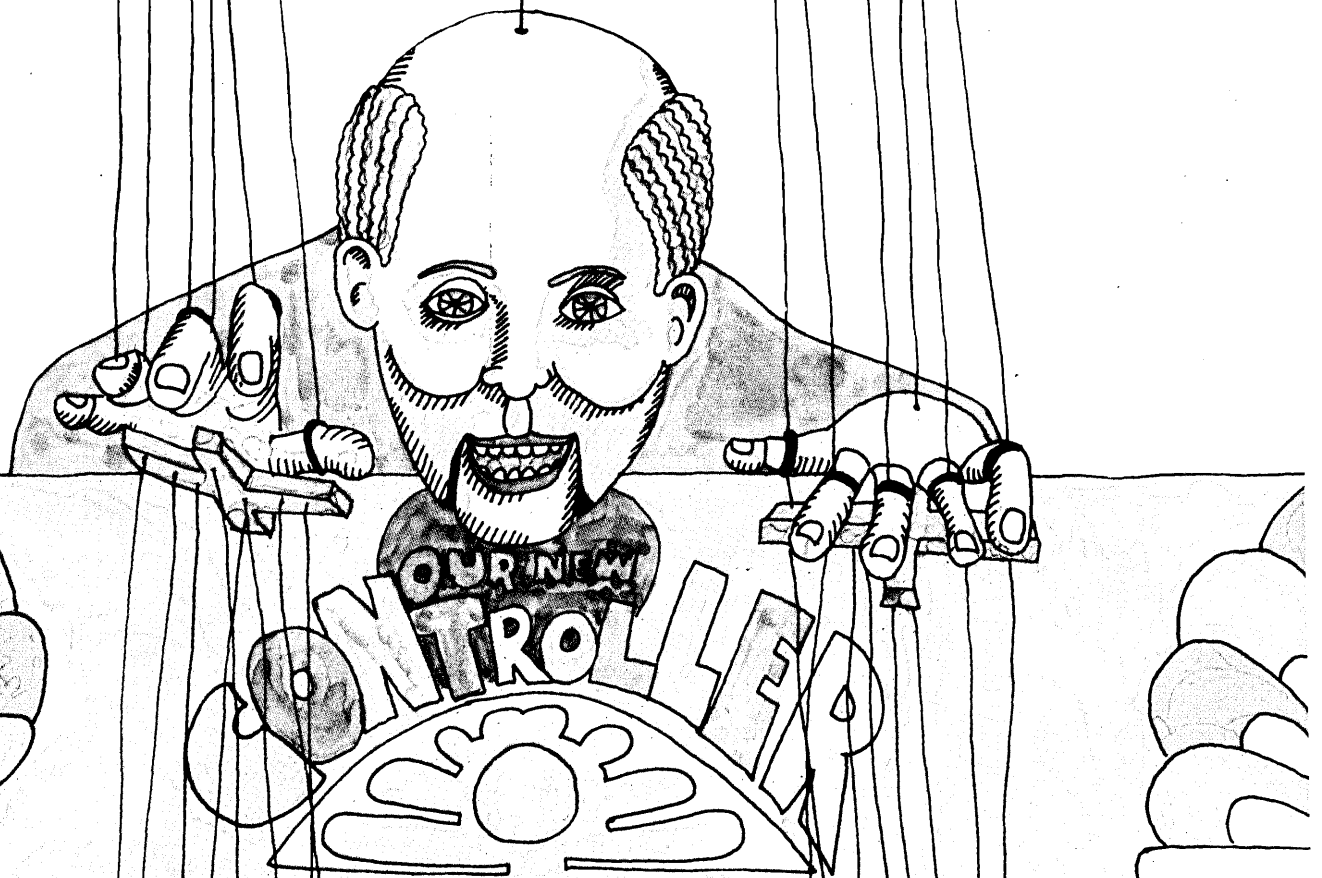

We make the best drum and disk memories on the market. So we developed a controller that would be compatible with all of them, and interface with a large number of computers. It was a natural step.

For example the DEC PDP 8 computer. Our system, consisting of the model 7100 Controller and a drum memory has an average access time of 8.7 milleseconds. The system is modular in design and is capable of being expanded into any configuration from the very basic single drum memory system to a very complex multi-processor, multi-drum system. When multi-memories are used, there are savings over competitive systems.

One more way we expand your memory.

CIRCLE 124 ON READER CARD

EXPAND YOUR MEMORY

**Vermont Research**  
CORPORATION

Precision Park, North Springfield,  
Vermont 05150  
Telephone 802/886-2256  
TWX 710-363-6533

DRUM AND DISK MEMORIES - CONTROLLERS



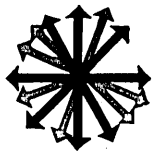

# new products

## time-sharing system

For sale: a dedicated time-sharing computer system with about the speed of an XDS Sigma 7 at less than half the price. Although speed is admittedly only a part of the story in evaluating computer offerings, the specifications for the TENET 200 read very nicely. For instance, the memory cycle time is listed as 800 nsec, and interleaving yields an effective time of half that number. Core access time is given as 325 nsec. The processor has been timed typically at 3.4 usec in a multiply and at a maximum of 7.8 usec in a divide.

The 200 is not a minicomputer that picks up its speed by using a smaller word. It is a 32-bit (plus parity) word machine and can be ordered with up to 128K of core. It can be shipped

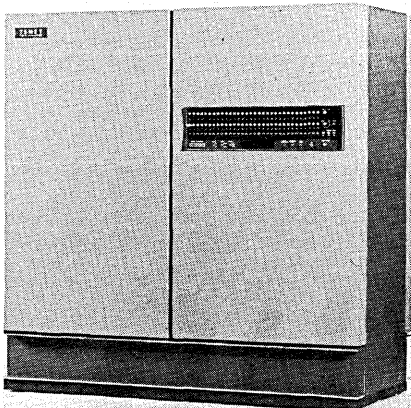

with multiple processors, too, and uses an instruction set of over 200 basic commands.

The system's architecture is actually most like a General Electric 600 series computer on a smaller scale. That is, the system is core oriented rather than processor oriented, and core interfaces with cpu's and i/o processors through a device something like GE's System Controllers. The designer's vocabulary sounds much the same too, given to terms like "master" and "slave modes."

Core is accessed through the Memory Access and Interrupt Processor (MAIP), which connects both to direct memory access channels and to i/o processors and cpu's. The MAIP provides 20 bi-directional channels with individual access priorities, 20 levels of nested interrupts (expandable each level to 16), and can operate four channels to memory at once at up to 1.25 million words/second. The i/o Processors can attach up to 16

terminals each, but are specialized peripheral controllers rather than general purpose devices.

The cpu is built with eight registers—seven of which can be used for indexing—and eight control registers, optional mapping, plus handles for performing user-defined instructions.

The big limitation of the system—if it is a limitation—is that it is dedicated to time-sharing and will not handle batch processing. In fact, the 132-column 400 lpm printer option is not being pushed. The 200 comes with two IBM 2314 compatible discs, a 36KC 9-channel tape drive, and one console typewriter for about \$325,000.

Software available is minimal: a single-pass meta-assembler, a symbolic debugger, a math library, a linking loader, floating point routines (for those that do not order the hardware), and something called a "fundamental" debugger. BASIC is due in June, FORTRAN IV in Nov., and COBOL in mid-1971. Deliveries begin in July.

Builders of the system feel that up to 96 commercial users could be on-line comfortably at one time. At least 32 scientific users, and perhaps 48, could share the single processor version. TENET, INC., Sunnyvale, Calif. For information:

CIRCLE 296 ON READER CARD

## small card reader

For those that think of card readers in terms of an IBM 1403, the SR-600 is a pleasant surprise. Although the unit



admittedly does not have the 1403's card punching capabilities or even its multiple output hoppers, it is small enough to sit on a desk yet reads 80-column cards at 600 per minute (51-column cards at 750 cpm). The 600 reads photoelectrically, serially, and can be ordered with interfaces to fit a user's needs whether for on-line use with a small to medium scale computer or for remote batch terminal use. It

comes packaged in a 16x24x25-inch box and weighs 125 pounds. Prices, with interfaces, will be in the \$7500 to \$8000 range. DATA PRODUCTS CORP., Woodland Hills, Calif. For information:

CIRCLE 301 ON READER CARD

## transaction terminal

That part of the data processing industry which is involved with point of sale systems is becoming more interesting. There is a fantastically large potential market for POS systems and the more general point of transaction systems. On the other hand, the immediate future seems uncertain for them and one of the most successful appearing (to date) of the lot, the TRADAR system, was recently taken out of service by its customer and co-developer, the J.C. Penney chain.

The president of this firm helped to develop the TRADAR terminal, feels

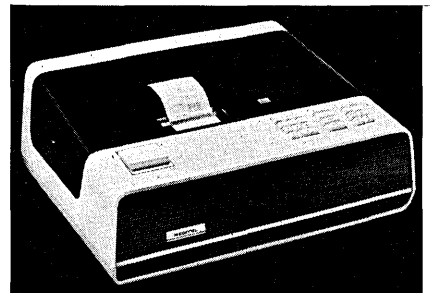

he knows how to improve on it, and is introducing his own version. Called simply the Regitel Point of Transaction System, this version is composed of neat-appearing terminals that operate as cash register replacements, a communications controller (probably the Data General NOVA, but which could be a Digital Equip. Corp. PDP-8 or a Hewlett-Packard 2114A or equivalent), and a communications multiplexor.

The terminal provides a printer, keyboard, operator display, power supply, and cash drawer, plus an optional ticket and card reader if desired. This hooks to the multiplexor over 300 baud lines. The multiplexor is expandable, in increments of 40, to be able to handle 120 of these lines. The multiplexor is connected to the controller, which can either be connected to a larger central site computer or to disc files.

The operator of a terminal is led, step by step, through the procedure for entering layaway, sales, or c.o.d. purchases by lights on the unit. Information from the transaction goes directly to the controller through the multiplexor and is edited and formatted for use by the host computer. Software is provided to format and order data to meet the requirements of existing ac-



# DATA

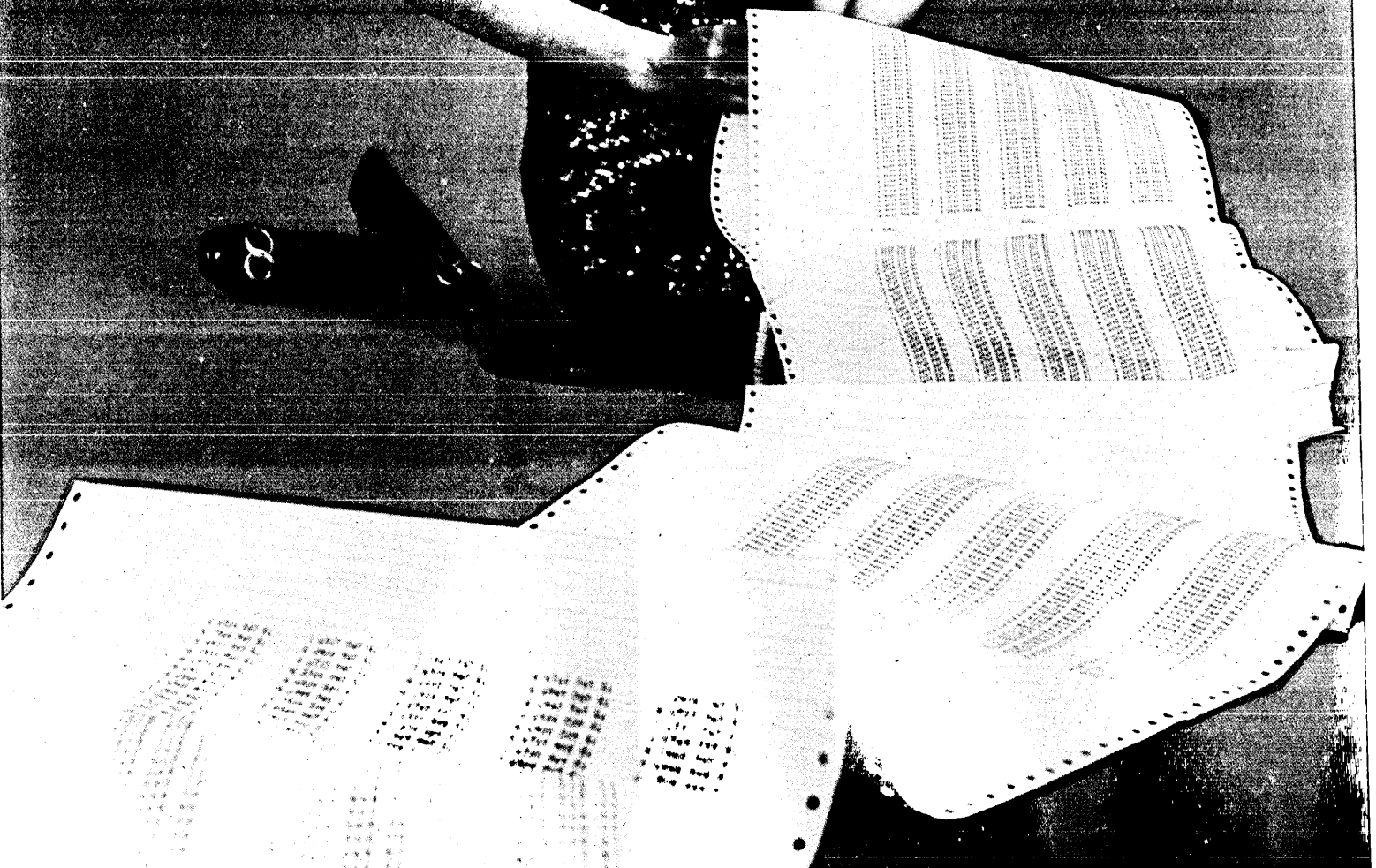

# ON A PLATTER

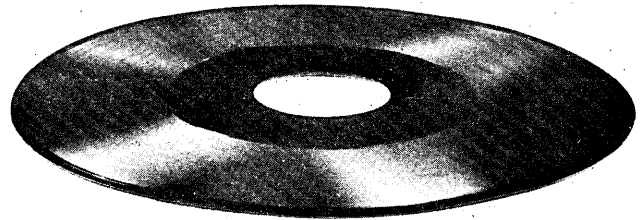

## ***New "juke-box" digital data input/output puts your data on records-for pennies a copy.***

You can now get your digital data on records! Sturdy. Compact. Tamper-proof. And for only pennies a copy.

Pressed into a vinyl base like an ordinary "hit" record, data on a platter is part of a new concept in data distribution, storage and retrieval—the first of a new generation of low-cost digital data products from EG&G.

As a random access mass-storage peripheral to CRT terminals and small computers, the DATAPLAYER\* Terminal gives you on-line random access to alphanumeric or digitized graphic data stored on DATAPLATTER\* Digital Records in any machine readable language. Capabilities include standard data bases, subroutines, instructions and complete computer programs.

\*Trademarks of EG&G, Inc.

A 7-inch DATAPLATTER record can store up to 5 million bits per side, accessible in seconds. On-line random access to a hundred or more records in a "juke-box" type changer could provide billions of data bits for CRT display, computer memory transfer, or hard-copy printout in 15 to 30 seconds. Data transfer rate is nominally 16 Kilobits per second (2,000 bytes).

*Look into this new, low-cost subsystem for your data processing. A free sample of the DATAPLATTER record mailed to you in an informative "booklet album", is yours for the asking. Write EG&G, Inc., Systems Development Division, Crosby Drive, Bedford, Mass. 01730.*



**DATAPLAYER Terminal** is a compact, solid-state, stand-alone peripheral. Individual plug-in boards contain stylus assembly and turntable, power supply, input and output interfaces, and control electronics.

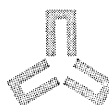

**EG&G**  
SYSTEMS DEVELOPMENT DIVISION



We're a head of our times!

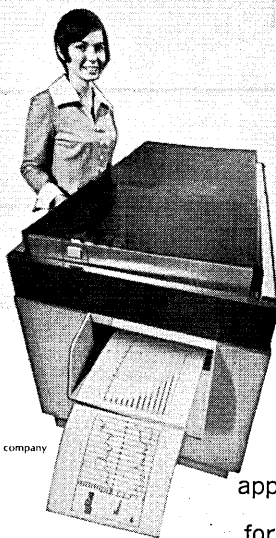

Even slight improvements in equipment are always appreciated . . . *but expected* if there is any justification for calling the equipment new.

However, when equipment is part of a new generation, then you expect truly significant advances. And, that's what you get with our new Data Plotter.

The basic electronic writing head in this second-generation plotter is a 10 by 10 matrix of wires spaced on .010 inch centers. With this unique writing head, you can plot up to 100 points per motor step, instead of the one point per motor step with a conventional plotter.

Use of vector commands, rather than individual point commands, permits the plotter to operate on an interrupt basis, which not only reduces your computer time . . . but simplifies programming time and complexity. Complete software and interfacing have been developed to directly replace your present plotting system.

Don't let the generation gap get to you. Get with the 70's by calling (617) 272-4445.

**GRAPHIC  
DATA,  
INC.**

169 Bedford Street, Burlington, MA 01803

CIRCLE 150 ON READER CARD

## new products ...

counting, inventory, and credit control operations.

Among the side benefits provided by the system are automatic credit verification, inventory control and merchandise routing (if the item is not available at the location of the sale, it is located and committed to the sale). As well as keeping better records, speeding transactions, and preparing computer input, the system eliminates paper work and performs some of the dp tasks. One of its biggest advantages will probably be its price. The vendor claims to be able to install a system in a small store for as low as \$50,000. Terminals with printers cost \$4250 (\$120/month), tag and ticket readers go for \$350-\$650 (\$15/month), and the controller with its multiplexor \$14,000 (\$450/month); all prices plus installation. AMERICAN REGITEL CORP., San Carlos, Calif. For information:

CIRCLE 299 ON READER CARD

### data distributor

There have been two ways to set up a computer configuration to handle extensive communications requirements. The brute force method was to use a large number of dedicated phone lines with a data set at each end. This way of solving the problem leads to inflexibility and very high phone bills. The preferred choice has been to incorporate a communications multiplexor or concentrator, which could either be inexpensive or flexible, but not both.

This vendor claims to have developed a third choice, a communications interface that is both flexible and relatively inexpensive. Called Multitran, the product is like a hard-wired multiplexor in cost, yet completely flexible in terms of the line speed mix that it will work with, as is a computer-based concentrator. The terminal end Multitran connects directly to any number of devices — computer output microfilmers, or crt displays or Teletypes, or other computers—without the intercession of individual data sets. It interfaces these to a phone line through a single data set to a microwave facility, or to any other transmission medium accommodating line speeds into the two million bps range. On the computer end, another Multitran can connect the incoming line directly to the computer's communications module (like the IBM 2701). And to both it looks like a data set.

As an example, suppose it is required to transmit data to and from 25 I/O devices at the following rates: one

(Continued on p. 202)

## PRODUCT OF THE MONTH

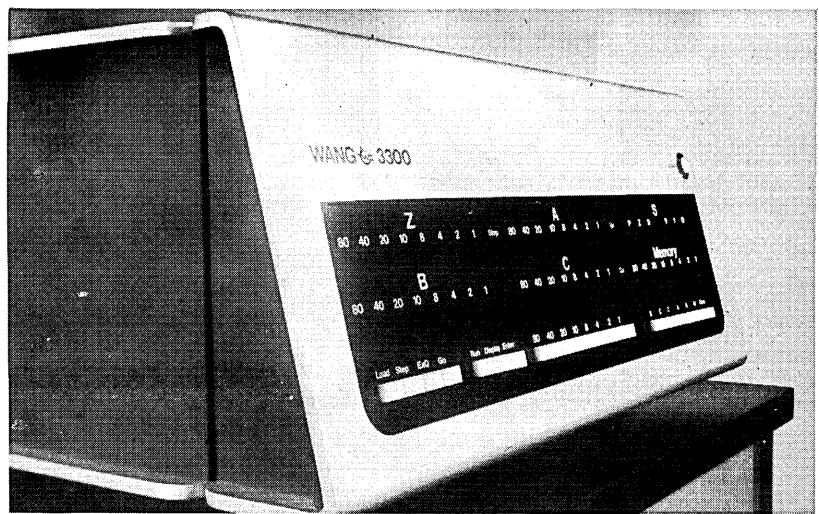

### mini time-sharing

Now one of the big calculator manufacturers has crossed over the thin line and built a mini time-sharing system based on a real live computer, the Model 3300. A byte machine, the 3300 uses an 8-bit word size which can be expanded by double precision software, a core memory with a 1.6 usec cycle time which can be ordered in sizes from 4K bytes to 65K, built-in binary and decimal arithmetic, a 72-instruction set with 21 memory reference commands, a push-down/pop-up address scheme, and a direct memory access channel.

Input stations are IBM Selectric I/O writers or ASR 33 Teletypes, and the cpu and its time-sharing executive can handle up to 16 of them. (Response times are expected to be in the two to five second range for up to eight simultaneous users running "average" t-s programs.) A standard part of each terminal is a dual magnetic tape cassette drive rated at 300 cps. Acoustic couplers are offered as options, and two discs, one 65K low cost unit and one .5 megabyte high speed unit, will soon make an appearance in the product line.

The 3300 is set up with an 8-bit accumulator, an 8-bit accumulator extension, an 8-bit addressable status register, and the claimed ability to use every byte of core as an index register. The designers also claim that double memory reference and arithmetic instructions give the 3300 instruction logic equivalent to "many" 16-bit computers. Five modes of addressing are used, including: in page, absolute (page 0 or page 1), immediate, and indirect.

CIRCLE 295 ON READER CARD

The system's speeds are given as 6.4 usec for a 16-bit binary or BCD add (4.8 usec for 8-bit words), better than 300kc for the transfer rate of the dma.

The 3300 is intended for commercial dp use. Its primary language is BASIC. Extensions to the compiler have been incorporated to provide for an "Immediate Execution" mode (giving one user complete control, this is also called "Calculator" mode), multiple instructions per line, COMMON data areas, 8-digit floating-point accuracy (with exponents from  $10^{-63}$  to  $10^{63}$ ), diagnostics, a program trace, and unlimited nesting.

Other software furnished includes an assembler, a source tape editor, a debug package, loader and rocs, and diagnostic routines. There is a charge for BASIC and other applications systems like it, and for applications programs such as the BASIC statistical package.

Like anything else, the cost of a time-sharing system should be figured by how much work is done per dollar. Because of its relatively low cost, the 3300 should show up fairly well in such calculations. A two terminal Selectric/cassette system runs \$17,550. If the buyer chooses the Teletype-based configuration without cassettes, the price falls to \$15,250. Additional Selectrics run \$2100, tty's are \$1750, and the cassette drives (which will be Newell's in the first systems) will go for \$1400. Couplers go for \$795 each, and there is a \$1500 charge for the BASIC compiler and system set-up (plus a maintenance cost for the compiler). WANG LABORATORIES, INC., Tewksbury, Mass. For information:



## new products...

batch terminal at 19,200 bps, eight crt's at 2400 bps, and 16 teleprinters at 110-150 bps. The Multitrans required to support these devices on a 40,800 bps phone line would run something like \$8900 for each end. Should that configuration change the next day, to one with more crt's and less tty's and without the batch terminal, for instance, the Multitrans might not even have to be upgraded. If the same phone line would suffice, then the same Multitrans would, too. The units would be switched onto the new input lines and the system put on the air. The cost saving is there in either case, the supplier says, since the combined costs of the multiplexors and 40.8 data sets is much less than 50% of the costs of the data sets and channel bank units which are replaced.

Smaller users will find the prices in their ballparks, too. Three channel units, for instance, built to send and receive at a total rate of 4800 bps, 9600 bps, or 14,400 bps, would run approximately \$3500 each. COMPUTER TRANSMISSION CORP., Los Angeles, Calif. For information:

CIRCLE 298 ON READER CARD

### key-to-tape

With the introduction of the 4300 Magnetic Data Recording System, Friden becomes the latest firm to enter the key-to-tape data entry market. The system consists of the 4301 magnetic data recorder which is the basic unit, the 4302 magnetic data keyboard, and the 4303/4304 magnetic data central pooler.

The 4301 is a stand-alone unit that performs the functions of a keypunch and verifier, but with added capabilities: It can be cable-connected to a central pooler or can act as one itself when equipped with a pooling adaptor. It produces computer-compatible

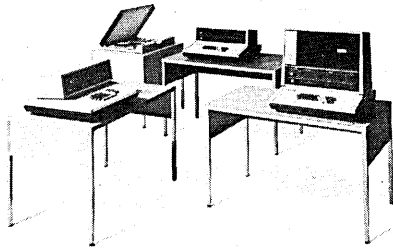

magnetic tape in 200, 556, or 800 bpi in 7- or 9-track formats. Data is entered through a conventional keypunch keyboard and displayed in English (or a foreign language). As a record is being keyed, each character

is placed in a buffer so that it may be erased to correct an error prior to recording on tape. Record lengths from 20 to 2000 characters can be used. Two stored programs provide the Enter, Verify, and Search capabilities. When used as a pooler, the 4301 can accept up to eight 4301's or 4302's in any combination. It may be purchased for \$7,000 in the 7-track unit or \$8,000 for 9-track. Lease prices start at \$130 a month. Data transmission capability is available optionally.

The 4302 magnetic data keyboard eliminates the recorder used in the 4301 but retains all other operating features. The stored record is transmitted in burst mode to a central recorder, either a specially equipped 4301 or a 4303 or 4304 central pooler. The keyboards may be loaded with common master programs from the pooler for maximum efficiency in preparing a composite input tape, or each can have individual programs entered from the keyboard. Purchase price of the 4302 is \$4,500. Leases start at \$85/month.

The 4303 magnetic data central pooler accepts up to sixteen 4301's or 4302's in any combination. The unit can accommodate 10½" (2400') tape reels, either 9-track 800 bpi or 7-track 200, 556 or 800 bpi. Features include



automatic load point, end-of-tape sensing, rewind to load point, tape cleaner, and optional data transmission capability. The 7-track unit is priced at \$10,500; the 9-track at \$13,500. Lease rates start at \$205 per month. The 4304 is the same as the 4303 except that it can handle up to 64 remote terminals and is more expensive—\$12,500 for a 7-track unit and \$17,500 for the 9-track model. Lease rates start at \$230 per month. FRIDEN DIV., THE SINGER CO., San Leandro, Calif. For information:

CIRCLE 300 ON READER CARD

### digital document storage

Although computer techniques have been implemented in many, many jobs where manual procedures could be done better and faster with a machine, in those applications where pieces of paper are really needed analysts have been stymied in their attempts to automate paperwork. The reason for this has been that the translations required between the pieces of paper we work with and the digital bit streams that computers work with make conversions almost impossible. The means previously open to users—keypunching, optical character recognition, microfilm retrieval systems, video storage

techniques—have been inflexible or slow or expensive.

Enter the Trans-A-File, a digital document filing, storage, and retrieval system. Many features set it apart from earlier products. First, it can read film or printed pages or magnetic tape or aperture cards or punched paper tape or some other kind of input media, either from a local peripheral or from a remote unit using phone lines. Second, that input is recorded onto extremely high density magnetic tape (at over 400,000 bpi) with an automatically assigned address. Third, the "image," which then exists in digital format, can be sought out, rearranged, sorted, translated into hard copy or viewed on a crt screen, or communicated to another remote site.

One reel of the one-inch wide tape used can store up to 34,320 8½x11 inch pages. Each page is carried as 400,000 bits and has two additional 1000-bit address tracks associated with it. At the high packing density used, each page requires about .84 inches of tape. Since the information is kept digitally, there is no image degradation in making copies, even with sorting or updating, and everything is computer compatible.

Trans-A-File was designed by a

private entrepreneur, Lee Siwecki, using available technology. (The forward/backward searching, high density drives, for instance, have been in use by the military for years.) The filing units—which read the printed documents—were designed specially. Some of the rest of the system is closer to stock specifications, including the drives and the controlling minicomputer. A system starts at about \$100,000 but the price may be largely dependent on the number of tape units desired (up to 18 may be configured), and on the types of terminals chosen. Deliveries will take about six months, and the first system is due to be delivered in June. TRANSAMERICA SYSTEMS CORP., San Francisco, Calif. For information:

CIRCLE 297 ON READER CARD

### s/iii next

IBM's System/3 may have some competition this Spring with the arrival of the Hetra s/III (and the smaller s/I and s/II too); the new series of computers will even use the 96-column card, as well as the conventional 80-column card. They're the first products of Hetra, a 40-man firm established over a year ago under the name Computer Network Systems Corp. Original

## CATCH OUR WAVE AND HANG THREE

Watch your input shoot the curl without consuming costly CPU time. The "ho-dads" from Input Beach make it happen.

Our Magnetic Tape Pooler hangs input gremmies like expensive converters, tape cartridge readers, and input software.

Combine our pooler with the Data Action Magnetic Data Inscrubber, and you've caught our wave. That means accurate, controlled offline data preparation.

Be a data entry Kahuna. Write, or call 612/927-5416 and holler "surf's up!"

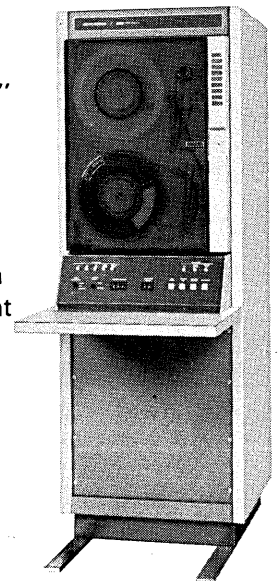

**DATA ACTION**  
**THE INPUT COMPANY**





## new products ...

goal of the company was to manufacture processors for use as communication front ends, store-and-forward systems, concentrators, and programmable remote batch terminals. But the System/3 arrived. And while many observers see the S/3 stand-alone computer as becoming a programmable terminal as soon as IBM can provide communications capabilities, Hetra suddenly saw an opportunity to follow in the wake of IBM's pioneering efforts and market their own equipment as stand-alone systems.

So the Series 200 Processor will now be utilized by three Data Processing Systems for both business and communications use. The 200's circuitry is more than half MSI, with TTL used throughout. Memory cycle is 1 usec. Variable word lengths are used, with the first language available the firm's own assembly language, Programmers Working Language, featuring self-defining instruction material and word length. PWL is said to resemble Autocoder. For S/3 compatibility, RPG II will also be provided, with FORTRAN and COBOL slated for the distant future. The company sees FORTRAN as an avenue toward turning their S Series into a potential 1130 replacement.

The smallest of the three, the s/i, has 4K 8-bit bytes of main memory, expandable to 16K in 4K increments. The larger s/ii and s/iii incorporate 4K 16-bit ROM's as well, but the instructions found on the ROM's are in main memory on the s/i. The s/ii includes the ROM and a 50-nsec scratchpad memory incorporating some LSI memory chips; this does not permit full overlap of peripherals, however. The s/ii will be available with 4-16K memory like the s/i, or with 16K memory expandable to 65K in 16K increments, like the s/iii. Both s/ii and s/iii will be available with a 1.2 million-byte 40-msec disc. The firm is buying all peripherals from other manufacturers. (Notably, IBM System/3 card-handling equipment will be used for the 96-column card.)

The S Series will use controllers to handle peripherals without going through the CPU. Each controller utilizes up to eight ROM-equipped peripherals processors, for a total of up to 64 peripherals per CPU. The peripherals processors will talk to the CPU. s/i prices begin at under \$10K and go to over \$25K. The ranges are \$20-75K for the s/ii, and \$40-200K for the s/iii. HETRA, Melbourne, Fla. For information:

CIRCLE 303 ON READER CARD

## small disc system

While others were off making IBM 2311 and 2314 compatible disc pack drives, this vendor built instead disc pack and disc testers. Since the technology used in building the testers was the same that would be used in building a drive, the firm might have been expected to go into drive production. It did, but on an entirely different level.

The Disk Memo is a small head per track disc memory designed to serve

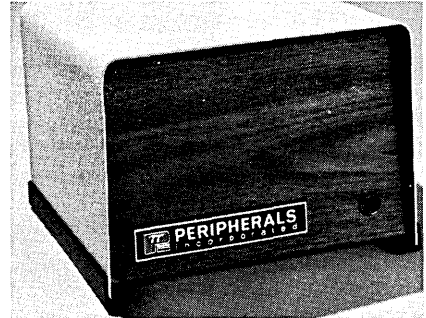

small and medium size computers. It offers an average access time of less than 8.5 msec, a transfer rate of 1.9 million bps, packing of 32K bits per track, and either eight or 16 tracks (256K on 512K bits). The unit is small (10½X10½X7 inches) and weighs only 10 pounds. The price per pound is not bad either. An eight track version sells for under \$2000 (in quantities

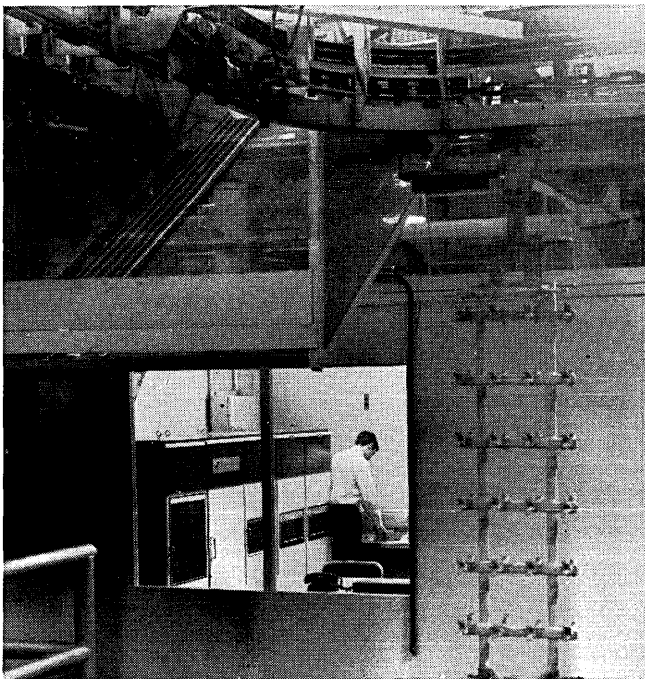

Ann Arbor control in parts plant.

# We make computers make things happen

Maybe you want to control equipment, or control a process, or inspect and test. Or perhaps you want to acquire and evaluate data. We make computers make things happen. Make things happen to reduce your operating costs.

Tell us about your ideas. We'll work with you to determine the feasibility of using a computer for control. In addition to hardware, we can supply all the software required. One source for the whole package.

Want more input? Send for our 8-page brochure.

**ANN ARBOR COMPUTER**



*a subsidiary of the*  
**JERVIS B. WEBB COMPANY**

415 W. HURON STREET / ANN ARBOR, MICHIGAN

of one); the 16-track version sells for under \$2400. The smaller unit is identical to the 16-track version and can be field upgraded. Computer manufacturers will probably provide their own interfaces, but one for the Digital Equip. Corp. PDP8/i can be made available. Initial deliveries begin this month. PERIPHERALS, INC., Phoenix, Ariz. For information:

CIRCLE 306 ON READER CARD

### fast optical memory

Optics seem to be playing a very big part in today's computer products. The om-1000 Read Only Memory is a good example. The 1000 works something like a 35mm slide projector, but its "slide" is actually a mask which contains a bit pattern. This kind of hard program is inexpensive and easy to produce compared to other forms of fixed programs, and infinitely more flexible.

The optics make the 1000 fast—its cycle time is given as 100 nsec and its access time as 70 nsec—but not necessarily cheap. Compared to an average core memory of equivalent size, the optical system may be three to four times as expensive. But it's 10 times as fast. Some kind of index should probably be developed for measuring very fast hardware like this, one that would take into account the bits per nanosecond per dollar. With that kind of a calculation, the "less than \$4000" price quoted for a 100,000 bit memory in OEM quantities would probably look very good to a user who really needed speed. (The system is also available in sizes down to 4K bits and up to 256K bits.) OPTICAL MEMORY SYSTEMS, Santa Ana, Calif. For information:

CIRCLE 302 ON READER CARD

### 3k-character crt

Would you believe a crt/keyboard terminal that displays full upper and lower case ASCII alphanumeric on a 3000-character field? That's the claim for the co:70, featuring "human-read-



able" true serif characters displayed in thirty 100-character lines. Text-editing capabilities permit insertion, deletion, or reorganization of any information in the file—from a single character to

February 1970

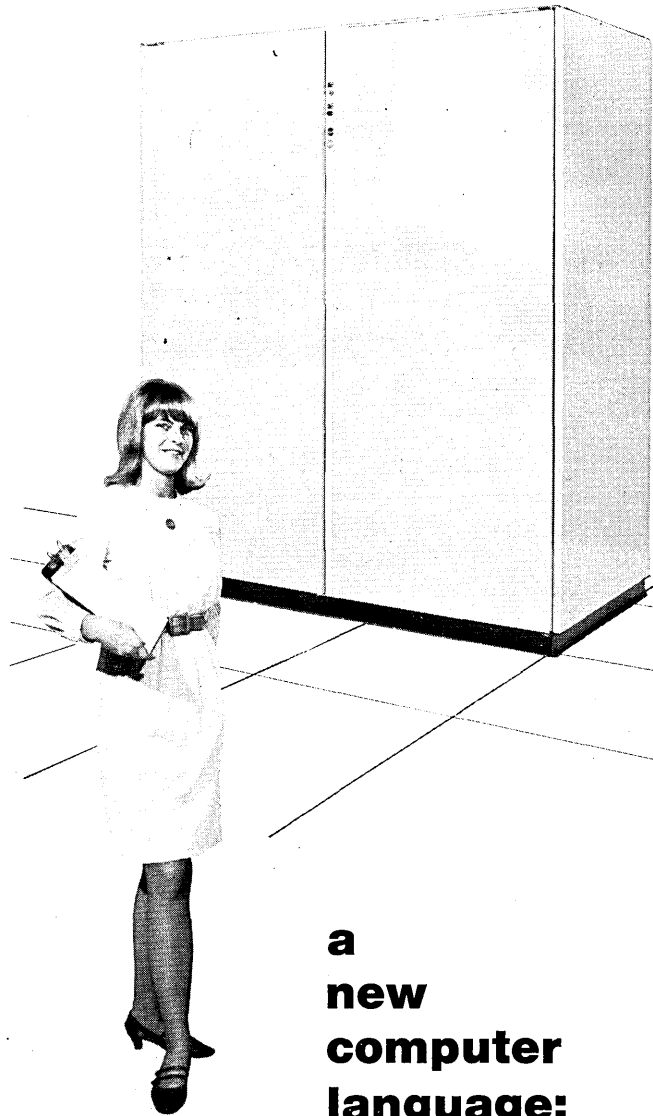

a  
new  
computer  
language:

## EDP + PEOPLE = EDPAC\*

EDPAC systems are designed specifically for data processing centers. EDPAC maintains the exact temperature, humidity and air cleanliness control required so that downtime is virtually eliminated.

Yes, EDPAC is a new language . . . invented to answer your EDP environment problems.

Want more information? Write: A.C. Manufacturing Co., Old Cuthbert at Deer Road, Cherry Hill, N. J. 08034.

# EDPAC

\*Electronic Data Processing Air Conditioning

CIRCLE 172 ON READER CARD

# Good luck with your bare bones computer.

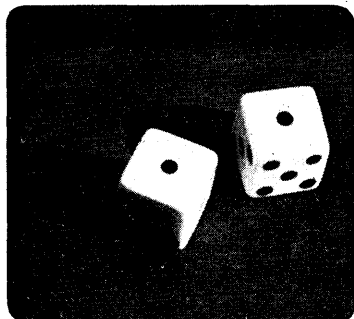

It's not hard to find someone who'll sell you a bare bones computer. The hard part comes when you look for a company to solve your data problems **once and right**. Daconics can and will. Daconics manufactures complete data and computer systems and peripheral subsystems. Including:

- The input peripheral
- The small computer
- The I/O writer
- The I/O formatters
- The mag tape unit
- The drum or disc memory
- The CRT display
- The strip or line printer
- The modem controller
- The I/O controllers
- The system engineering
- The software executive
- The diagnostic routines
- Interconnect and power cabling
- Factory integration
- Factory system test
- Customer training
- Design documentation
- Operations and service manuals
- Warranty

Write for our new brochure.

## DACONICS

505 W. Olive Avenue,  
Sunnyvale, CA 94086  
Phone (408) 732-2634

CIRCLE 109 ON READER CARD

## new products...

large blocks of data, and automatic editing and re-positioning of text during addition or deletion of characters, words, or sentences. Stand-alone functioning is permitted via built-in memory which allows operation without a control unit. Units may be operated in "clusters" through use of an optional remote data adapter which drives the co:70 raster unit; the "satellite" crt's then share the 3000-character capacity, however.

Options permit the user to call out special symbols and varied combinations of the full fields. Other options include mag tape cassette or paper tape input or output; punched card input; push button data generation; hard copy generation under operator or computer control; over 2400-baud telecommunications capability; line drawing graphics capability; multi-colored display; x-y positional addressing; and EIA standard video mix for closed circuit tv. Nationwide maintenance will be provided by Honeywell. Price range is \$59-268/mo. Delivery requires 6 months ARO. COMPUTER OPTICS INC., Bethel, Conn. For information:

CIRCLE 307 ON READER CARD

### acoustic coupler

This acoustic coupler will transmit/receive in full or half duplex modes, switch selectable, at rates up to 300 baud. Interface cables are available for Teletype 20ma and all rs-232b equip-

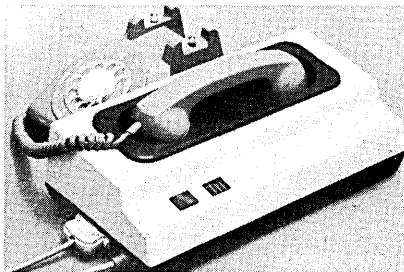

ment. The coupler is priced at \$395, with quantity discounts available. INFO-MAX, Palo Alto, Calif. For information:

CIRCLE 310 ON READER CARD

### crt terminal

The Univac DCT 1000 crt terminal is available either as a single station or with multi-station capability. It consists of an asynchronous I/O printer with 132 print positions operating at 30 cps, a control unit, and a keyboard. Up to three I/O devices can be added in any combination of card readers, paper tape readers and punches, and card punches. The 1000 is fully compatible with the Uniscope 100 crt

# LEARN APL

## Intensive 2-day courses now offered in APL time sharing

APL, developed at IBM, has been called the most important concept in computing since FORTRAN. It's 5 to 12 times more powerful than FORTRAN, much faster to program... yet is easier to learn and use than BASIC!

Here's **your** chance to learn to use APL in a two-day "total immersion" course presented by the national leader in APL time sharing. You can take this course in Washington, Philadelphia, New York, Boston, Los Angeles, Chicago or Toronto.

You are on-line to our APL PLUS system from an individual terminal throughout the two-day course. With specially prepared video tapes, a new APL textbook, closed circuit TV and personalized instruction by experienced APL users and lecturers, you will quickly become adept in using APL for problem solving.

The cost? Just \$250 per student.

For details and schedules, contact: Registrar

## Scientific Time Sharing Corporation

2101 S Street, N.W., Washington, D.C. 20008 202-462-4620  
The National Leader in APL Time Sharing

CIRCLE 111 ON READER CARD

terminal and multiplexor and may be used on a mix and match basis on the same multiplexor and/or communications line. Specifications include 300, 1200, and 1800 bps asynchronous transmission, or 2000-4800 bps synchronous in half duplex mode. Error checking is provided by block and character parity and retransmission. Two 160-character buffers are employed. First deliveries are scheduled for July. Rental is \$140/mo., purchase \$5.3K. UNIVAC, Philadelphia, Pa. For information:

CIRCLE 312 ON READER CARD

**printer**

The Execuprint I desk top printer is designed for use with the company's Executerm I crt terminal. The unit prints 80 characters/line at 11 cps and

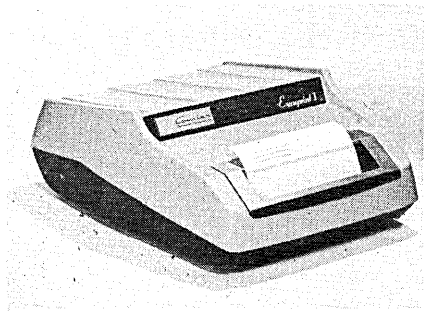

houses its own paper supply in roll form. Unit price is \$2100. The \$78/month lease price includes maintenance. COURIER TERMINAL SYSTEMS, Phoenix, Ariz:

CIRCLE 313 ON READER CARD

**disc memory**

There was a hole in the product lines of the disc memory manufacturers that this vendor found and filled with the Model 8504 disc storage system. Small, slow discs were made for minicomputers and large, fast ones for medium and large scale computers, but no one, this builder claims, built a large, slow disc to give the minicomputers the storage capacity that the larger computers enjoyed at data rates they could handle. Enter the 8504, a 6.4 million bit storage system with a 1.46 million bps transfer rate. The system uses 128 tracks with a fixed head per track, stores 50,000 bits per track, and accesses data in an average time of 16.6 msec. The vendor claims that his configuration is just right for 16-bit processors among others, and unit prices it at under \$9000. (That makes the price of the disc system about the same as the price of some small computers, but might save the user from going to a larger computer just to have more on-line random access storage.) MAGNAFILE, INC., Phoenix, Ariz. For information:

CIRCLE 309 ON READER CARD

**360 interface**

The 360 CHANNEL INTERFACE, intended to help minicomputer and independent peripheral suppliers penetrate the S/360 market, is a self-contained unit that provides an IC level interface to IBM 360 selector and multiplexor channels. Connectors on the unit accommodate two pairs of 360 I/O cables to permit chaining. Unit price is \$1925. The company plans to introduce comparable units for interfacing with Univac 1108 and 9000 computers, and GE 400/600 systems. DATAMETRICS CORP., Van Nuys, Calif. For information:

CIRCLE 311 ON READER CARD

**voice response system**

This voice response unit and audio multiplexing system was built to give IBM 1130 users voice access to their data banks for applications such as credit checking, stock quotations, and inventory control. Called the cr-114, the unit connects to the computer's SAC or SAC II channel and works in conjunction with normal phone equipment as long as the caller has access to a touch-tone phone or a touch-tone pad connected to a standard rotary dial phone.

The 1130 can be given a vocabulary ranging from 31 through 189 words or

phrases. These are recorded on an appropriately sized drum, and can be accessed from multiple phone lines through the multiplexor using software constructed in FORTRAN. Routines are included to perform all the required hand-shaking functions necessary when dealing with telephones.

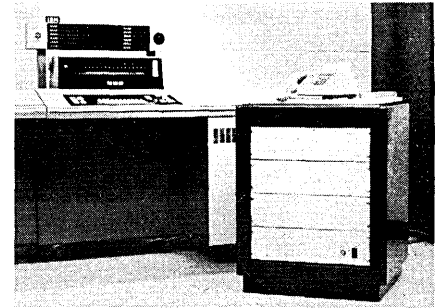

A single trunk line system with a 31-word vocabulary, the simplest version, sells for \$8200 including software or may be acquired through a third-party lease for as little as \$190/month. An eight trunk system with 64 words would cost something around \$50,000. DATATROL, INC., Hudson, Mass. For information:

CIRCLE 305 ON READER CARD

**3600 bps modem**

Modem 3300/36 is a data set capable of transmitting at 3600 bps over dial-

# THE OUTSTRIPPER

**More message in less line time. Because this readout terminal sprints as it prints... it literally outstrips the field... and does it far longer with a minimum of 100 million maintenance-free operations! Size and weight are surprisingly small, but the 64 characters (ASCII code) are large. Result: virtually instantaneous readout of 120' high x .070" wide characters, spaced nine per inch. Send coupon today.**

**NEW DATALINE  
DESK TOP  
STRIP PRINTER  
REDUCES  
LINE TIME.**

**DATALINE**  
INC.

The Best In Priced Easy Data Terminals  
151 SOUTH DORR LANE ROAD  
QUAKERTOWN, PA. 17086  
TELEPHONE 215/862-8788

**DATALINE**  Sounds great!  
Tell me more.

NAME \_\_\_\_\_

TITLE \_\_\_\_\_

COMPANY \_\_\_\_\_

STREET \_\_\_\_\_

CITY \_\_\_\_\_

STATE \_\_\_\_\_ ZIP \_\_\_\_\_

DM

CIRCLE 115 ON READER CARD

## new products...

up phone lines or unconditioned leased lines. Reverse channel is 150 bps. It is the first of a new series designated Modem 3300, and the firm hopes it will be highly competitive with proposed 3600 bps Bell equipment. Rental is \$125/mo., purchase \$3995. INTERNATIONAL COMMUNICATIONS CORP., Miami, Fla. For information:

CIRCLE 316 ON READER CARD

### adding machine terminal

For applications that can settle for numeric input, such as inventory control or order processing, the CP440 Addo-Tel system provides remote keyboard to keypunch data entry. The system comprises an adding machine which interfaces to a data set on the sending end, and an interface that links a data set to a keypunch on the receiving end.

The Addo-X adding machine is capable of working with up to three separate data fields and from five to 12

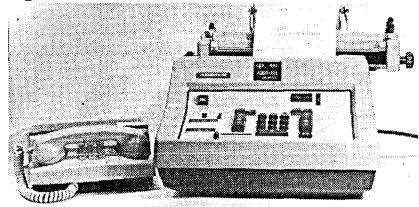

digits. As an on-line input station the adder and interface will sell for around \$1900. The receiving end interface adds about \$1100 to the price. Data sets and the keypunch are not included. COMPUTER PRODUCTS, INC., Seattle, Wash. For information:

CIRCLE 317 ON READER CARD

### disc drive

Friden has developed and will service a disc drive functionally identical to the IBM 2311 model, with 7,250,000-byte capacity, 73 msec average access time and 156kc transfer rate. The disc drives will be leased through Talcott Computer Leasing as the Talcott 9311 for \$400 a month on a one-year lease (\$375 for two years, \$335 for three), including maintenance. The 9311 will plug into a 2814 control unit and may be intermixed with similar disc drives plugged into the same control unit. Any IBM 2311-compatible disc pack may be used. The 9311 features an electronic servomechanism for head positioning, rather than the hydraulic system more generally used, and this is said to result in lower maintenance and manufacturing costs. FRIDEN DIV., THE SINGER CO., San Leandro, Calif. For information:

CIRCLE 314 ON READER CARD

### semiconductor memory

To cut itself in for a share of what is expected to be a \$100 million per year semiconductor market by 1975, Motorola has combined mos and bipolar logic in an 8K bit memory module designed to be fitted into main computer storage. The 1.6 inch cubed memory module stuffs all of the decoder and driver logic needed to operate independently into its small space, but is expected not to be used as a stand-alone. Its speed and price put it in the range of mainframe memory, and computer manufacturers are expected to greedily order it by the thousands.

Memories constructed from the component won't be cheap—even in OEM quantities the module is expected to cost 10 cents per bit—but they will be fast. Access times exhibited by the units are 120 nsec; full cycle times are 150 nsec. Deliveries begin in the second half of this year. MOTOROLA SEMICONDUCTOR PRODUCTS, INC., Phoenix, Ariz. For information:

CIRCLE 315 ON READER CARD

### teleprinter replacement

The tcc 1601 character printer, designed as a plug-for-plug replacement for Model 33 or 35 teleprinter, is configured for ksr operation. The printer provides a parallel i/o interface and is optionally offered in EIA RS-232B standard serial interface. The 64-character ASCII subset is printed at 10 or 15 cps. Unit prices range from \$1450 to \$1650, depending on quantity. Future models will incorporate paper tape handling for asr, as well as full 96-character ASCII type set. TRACOR COMPUTING CORP., Austin, Texas. For information:

CIRCLE 318 ON READER CARD

### data acquisition

The components in an analog data acquisition and control system are no secret. A system requires a multi-



plexor, an analog to digital converter, and a cpu with its peripherals. The sp5000 system has one difference that is claimed to be a "first time ever" addition and a big selling point—its

analog/digital converter is self-clocking, and this reportedly adds a great deal to the system's flexibility.

The first example of the sp5000 was built for a bio-medical application, but the system is not biased toward that field. The first unit had eight channels with individual sample and hold rates, a 50kc alphagraphic crt monitor, a 300 cps paper tape reader, 25kc 9-track tape drive, a paper tape punch, Selectric-based i/o writer, and a built-in MAC 16 minicomputer. From that size, the system can be configured, through choices of cpu and peripherals and channels, up to a 256 channel unit, or even further. The bio-medical version is based at about \$50,000, but a general purpose eight channel configuration without the crt could be built to sell in the \$35,000 range. In any configuration, the cpu is relieved of some incrementing and decrementing task by MSI counters built into the multiplexor data channel gear—another selling point. CIVIL SYSTEMS, INC., Anaheim, Calif. For information:

CIRCLE 319 ON READER CARD

### i/o printer

The maximum input speed for the cp902 Input/Output Printer is listed as 15.5 cps, and printing can be up to 16.7 cps. These speeds may be a little faster than some other typewriter-based terminals, but the big advantage of the device is probably the fact that the type bar print mechanism can hammer out up to 15 copies—a feat which should not be attempted with a wheel, slug, or golf ball printing element, this vendor claims.

The 902 is available in several versions, including input-only or output-only, coded (ASCII, BCD, and Teletype-setting codes are standard) or uncoded. The unit's 45 keys allow for 90 characters, and a one character mechanical keyboard buffer is built-in. The unit price for a coded input and output model is given as \$1240, and extra cost options—for pin feeding, 12-pitch type, longer carriage etc.—can bring this up a little. COMPUTER PRODUCTS, INC., Seattle, Wash. For information:

CIRCLE 304 ON READER CARD

### low cost tape handlers

Built for use with the GE-115 computer, the mrs110 mag tape subsystem allows for attaching up to four slow speed tape drives to a single controller at relatively low cost. The drives use single capstans and can handle 200 bpi or 556 bpi 7-track tape at speeds to 18.75 ips, corresponding to a 10.4kc maximum transfer rate. The units read forward or backward in continuous or start/stop mode. Writing, too, can be continuous or start/stop. The mrs110

# From Tel-Tech

# two new

# multiplexers

Full contention... total traffic monitoring  
... proven reliability

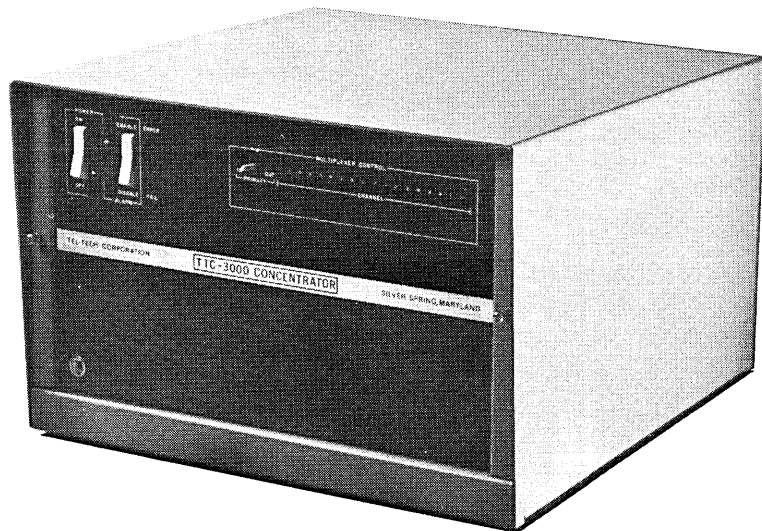

Over a year ago, Tel-Tech introduced the TTC-1000 Concentrator. Several hundred are on-line today. It has proven utterly reliable and is practically maintenance free. Ask a user.

Now Tel-Tech proudly introduces two new models... the TTC-2000 and TTC-3000. Both embody the proven technology of the TTC-1000. With this range of units you can select the multiplexer with the precise features you require.

**TTC-2000 Concentrator**... The ideal unit for point-to-point communications networks. Gives you basic simplicity and flexibility for changing requirements. Individual channel indicators show system traffic and verify the availability of channels. Multiplexes 2 to 38 channels.

**TTC-3000 Concentrator**... Provides full contention. Ideal for a network where the load shifts from city to city at different times of day. It allows multiple cities to contend for up to 38 channels on a

single phone circuit giving you more efficient use of your computer.

With both models, you can intermix data speeds... connect to any terminal... have built-in modems... and choose from a host of industry-first options. And you'll like the price too. Delivery is quick and engineering support is alert and responsive.

Call or write for information.



**TEL-TECH  
CORPORATION**

TELECOMMUNICATIONS  
TECHNOLOGY

9170 Brookville Road  
Silver Spring, Maryland 20910  
Phone: (301) 589-6035

Also ask about Tel-Tech's line of Bell compatible modems... TT-103, TT-202, TT-201.



## new products ...

is compatible with IBM 729, IBM 7330 and GE-400 tape handlers. A subsystem consisting of a controller and one drive sells for \$20,880 and rents for \$500/month. Each additional tape handler goes for \$8,450 or \$215/month. Deliveries take six months. GENERAL ELECTRIC CO., Phoenix, Ariz. For information:

CIRCLE 308 ON READER CARD

### hospital mini t-s

The Com-Comp I is a time-sharing system for use by hospitals, the first product of a year-old 35-man firm which intends to offer a line of special-purpose, communications-oriented systems. It utilizes a Micro 812 minicomputer cpu with 12K memory, expandable to 32K, handling up to 60 terminals. Software packages, written in assembly language, perform functions of a clinical pathology laboratory, including development of work lists, control of automatic analyzers, and patient billing; additional applications are in the works. The system operates in an interactive mode, yielding immediate responses to user inquiries. Standard Teletypes may be used, although an optional modified tty is available that is equipped with seven special-func-

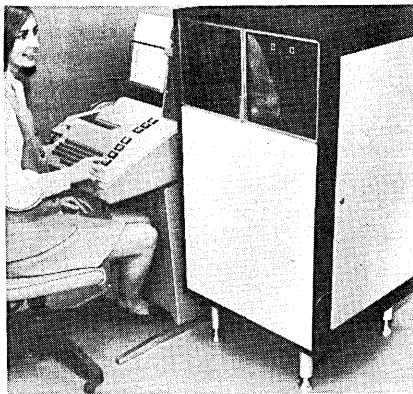

tion keys set to the right of the keyboard, permitting printout of special categories of information. Initial marketing of the Com-Comp I will be undertaken within a 200-mile radius, and the firm will provide its own maintenance. Prices start under \$100K, with delivery requiring about six weeks ARO. COM-COMP, INC., Hauppauge, N.Y. For information:

CIRCLE 321 ON READER CARD

### disc drives

Apparently because of an increased willingness on the part of the government and other sophisticated computer buyers to buy peripherals from someone other than a mainframe supplier, there has been seen an increased willingness on the part of the non-mainframe suppliers to build "com-

patible" peripherals. The best example of this is in disc drive manufacturing, and here is another case in point.

The Model 711 disc pack drive and the Model 733 are compatible replacements for the IBM 2311 and IBM 2314 disc pack drives. Built to be almost exact duplicates of their IBM counterparts, the 711 (for 10-surface packs) and the 733 (for 20-surface packs) have two main advantages over the originals, lower prices and additional operator controls. The 711 sells for under \$18,000 and the 733 for under \$25,000. Each has a built-in maintenance panel for determining drive and line problems and a control for manually returning the heads to track zero. Deliveries, which begin in April for the six-pack drive and in July for the larger unit, take 60 days. PERIPHERALS GENERAL, INC., Cherry Hill, N.J. For information:

CIRCLE 322 ON READER CARD

### process controller

Baby brother to the GE-PAC 4020 process control computer, now four years old, is the GE-PAC 4010, which is aimed at applications smaller than those which can be economically handled by the bigger machine. Although built from much the same circuitry—but perhaps less of it—the 4010 offers two new subsystems, a 600 points/second scanner and a dual-bulk memory

## Now from Datapro 70. Get five new reports on key-to-tape data recorders absolutely free.

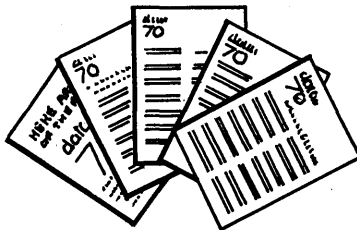

It's true. And there are no strings.

We want you to see for yourself just how much Datapro 70 can help you make the buying decisions you face.

Datapro 70 is the first and only complete hardware/software reference service that's made specifically for EDP management. It evaluates computers, peripheral equipment, software packages, and the companies that produce and market them. And the evaluations are clear, concise, and totally objective. (The guys who write them

are among the brainiest EDP analysts in the country.)

So write or phone us today. We'll send you our complete reports on the new data recorders from Data Action, IBM, Mohawk, Sangamo, and Viatron. Plus a few other surprises. And we'll include our illustrated brochure that'll tell you all about Datapro 70.

Send for your free reports today. We're betting you'll want the rest of Datapro 70 tomorrow.

**datapro  
research**

A DIVISION OF COMPUTER CONVERSIONS, INC.

Benjamin Fox Pavillon, Jenkintown, Pa. 19046 (215) TU 6-0100

CIRCLE 123 ON READER CARD

controller that can handle two discs or drums.

A 24-bit machine, the 4010 performs an add in one cycle, or 1.6 usec. The 16K word core memory, also of 1.6 usec cycle time, can be augmented by drums (8.7 msec access time, 40kc transfer rate, and 524K capacity; and by discs (90msec access time, 42kc transfer rate, and one or two million word capacity).

Software existing for use on the

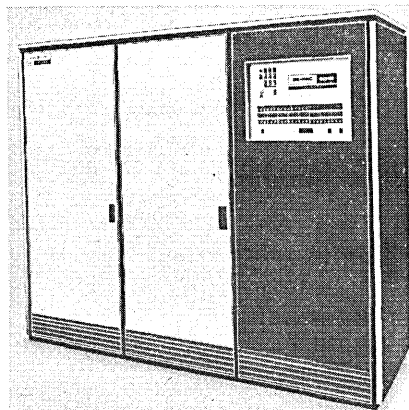

4020 fits, including BICEPS for supervisory control, GE-DDC for direct digital control, and FREETIME IV for background processing among others. The monitor, RTMOS, allows for real time multiprogramming operation and supports "fill in the blanks" and conversa-

tional coding. With the 16K core and the analog scanner, the 4010 sells for about \$78,000 (compared to a figure of \$110,000 for a comparable 4020). GENERAL ELECTRIC CO., Phoenix, Ariz. For information:

CIRCLE 323 ON READER CARD

#### message switching

A joint marketing venture of a computer manufacturer and a software house has resulted in the formation of the ics 500, a hardware/software message switching system built around xds Sigma 5 computers. For a fixed price the user gets a customized, dedicated computer complex and a very full complement of support services—he can even choose not to run the thing himself.

The ics 500 hardware consists of a single or dual Sigma 5 processor plus a specially developed i/o processor called the CROP. Each cpu has a 128K (32-bit) core with a cycle time of 850 nsec and an aggregate data transfer rate of 2.4 megabytes/sec using 192 channels. Each CROP terminates a maximum of 128 communication lines, which can be a mix of simplex; duplex, synchronous or asynchronous facilities. The lines accept data in any five- to eight-level codes.

The software consists of proprietary Informatics, Inc., programs tailored to

fit specific needs; and an executive, line handler, data management, and communications modules are included among others.

Support begins at the planning and specification level and continues through installation and personnel training, extending as far as facilities management. The minimum buy-in price is approximately \$3/4 million (\$500K for hardware and \$250K for software and services). Two systems are installed—one at the Federal Reserve Bank and one at Dun & Bradstreet. XEROX DATA SYSTEMS, El Segundo, Calif. For information:

CIRCLE 324 ON READER CARD

#### plotting system

Second product of a firm which spent last year promoting a time-sharing plotter controller is a plotting system including the TSP-12 Plotter Controller, plus a specially-designed x-y recorder built by Honeywell, and a 10-x15-inch plotter. The system, known as TSP-212, connects directly to tty's, IBM 2741's, etc. A single-cable connector accomplishes interface through data set or coupler. Operator-oriented controls are positioned on the front panel, and plot sizes are continuously adjustable through an "absolute plot dimension" pushbutton facility. Subroutines in BASIC and FORTRAN are supplied;

# Computer Companion

## #781

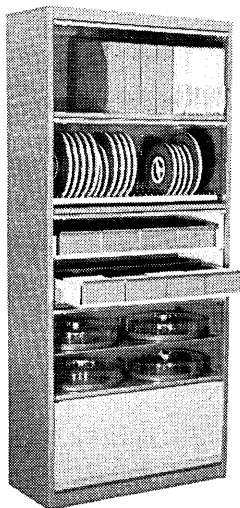

New versatility from Tab. The Large Document Spacefinder.

Each cabinet provides enough clear space to store virtually all your computer related media. And the panel doors lift and retract to allow easy access to ma-

terials. There are two, three, and five compartment models in your choice of the latest computer colors.

Tab has a companion for everything you need in your computer room.

Write us.

## TAB

PRODUCTS CO.

2690 Hanover Street  
Palo Alto, California 94304

CIRCLE 52 ON READER CARD

## new products...

these routines are usable with many computers not having full code-set output capabilities. The software has

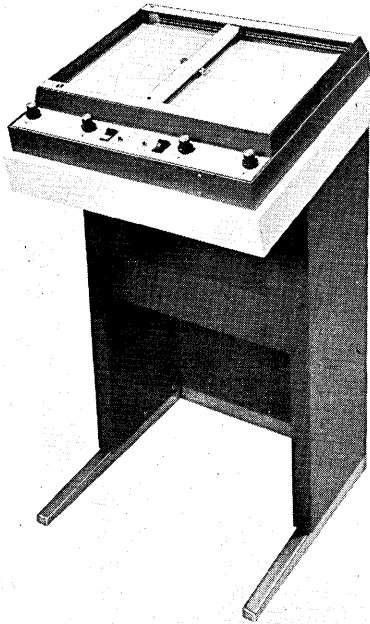

scaling and dimension factors, and alphanumeric and symbol routines are available for many systems. x-y plot dimension are .1% continuously ad-

justable up to maximum plot size; resolution is .12% of full scale; accuracy is .2% of full scale; plotting speed is 150-225 points per minute depending upon system used. Price is \$3300 including pedestal. TIME SHARE PERIPHERALS CORP., Wilton, Conn. For information:

CIRCLE 326 ON READER CARD

### mag tape units

The vt 6000 and 8000 series of tape transports employs servo-controlled single-capstan tape and reel drives to move the tape at up to 32 ips using either 10½" or smaller reels. The 6000 reads and writes 200, 556, or 800 bytes with IBM-compatible seven-track tapes; the 8000 offers 800 bpi, nine-track format and a 25.6kc transfer rate. Both units are supplied with read/write electronics, power supply, and operator's local controls and indicators. Five configurations may be ordered: complete read/write system (read-after-write capability optional), write only system, read only system, tape transport assembly with read heads and power supply, or tape transport and read heads only. The nine-track read/write system sells for about \$3500 in OEM quantities. VANGUARD DATA SYSTEMS, Irvine, Calif. For information:

CIRCLE 325 ON READER CARD

### video monitor

A video computer terminal should ideally be more than a Teletype replacement. Commercial users often want to see charts of earnings or sales volume, and scientific users often would like to see a trajectory or a signal amplitude curve. Teleprinters are not good at graphics and crt's that

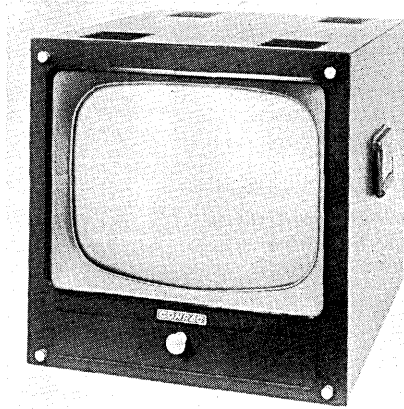

are good are often expensive. The RQA series of crt monitors is designed with text, graphics, and cost in mind. The 14-, 17-, and 21-inch screens are built for displaying graphics and text, but more important, they are built to automatically determine from a computer transmission which is being sent—text or pictures—and compensate by adjust-

# If you don't have one... let's hope you never need it

Valuable taped data can be erased or partially destroyed by unexpected exposure to magnetic fields... generated by electrical equipment, electronic gear, air transport instrumentation, electrical storms, etc. Such loss is costly and inconvenient. The data may even be irreplaceable.

### Avoid these hazards

#### Use NETIC Tape Preservers

for storing and transporting your valuable tape data. They provide ideal insurance against such potential hazards. Available in numerous sizes and shapes to fit your needs.

Delivery from stock. Request catalog No. TP-1

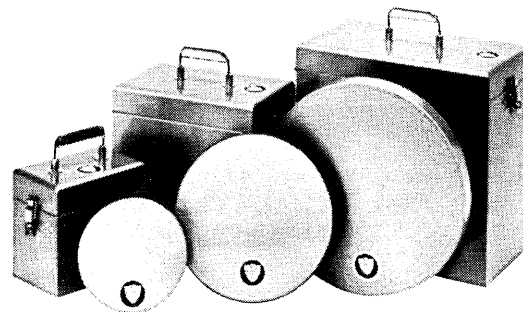

## MAGNETIC SHIELD DIVISION

Perfection Mica Company

740 THOMAS DRIVE • BENSENVILLE, ILLINOIS 60106

Phone 312, 766-7800 • TWX 910 256-4815

# Buddy, can you spare a byte?

That's a dirty tape for you. It'll put the bite on your computer every time. Dirty tape causes data drop-outs. And drop-outs cost you money. Bum deal.

RCA Computer Tape helps computers lead more productive lives.

It's a special formulation that starts cleaner. Every inch of every reel is tested and certified in the cleanest of white room conditions. (We believe statistical testing is begging the question.) And it stays cleaner, longer.

So? Fewer drop-outs, more efficient computing.

Show your computer what the good, clean life is all about. Write RCA Magnetic Products, 201 East 50th Street, New York, New York 10022.

The first step is clean tape. Ours.

**RCA** Computer  
Tape



## new products ...

ing the resolution, screen refresh rate, and input sensing rate. Refresh rates vary from 15 to 60 times per second, and the resolution can go from 500 lines per frame to 4,930.

The RQA's are not terminals. They are the crt's for the terminals, and come sans character generators, etc., but will undoubtedly find homes in many manufacturers' lines. Unit prices, depending on crt tube size, are \$1390, \$1410, and \$1510. CONRAC CORP., Covina, Calif. For information:

CIRCLE 327 ON READER CARD

### tty subsystem

The 100/200 is a subsystem to improve and expand the data communications capabilities of the good old Teletype. It consists of a set of circuit cards in an expandable rack with power supply which add additional functions, such as universal interface and parity control, transmit character detector, events counter, auto receive parity check, character regenerator, receive character detector, and automatic reader control. The subsystem can be configured to meet users' needs at a price range of \$75 to \$1000. Aver-

age functions run to \$150, but for \$75 you would get EIA compatibility—and if that's all you want, they'll sell it to you. The firm hopes to attract end-user customers; people handling large masses of data for business time-sharing or batch processing. And, of course, those desiring to update older tty's. KSW CONTROLS, INC., Fairfield, Conn. For information:

CIRCLE 328 ON READER CARD

### digitizer

The Datagraph Digitizer is a graphic input tablet that interfaces with a computer or terminal. The standard

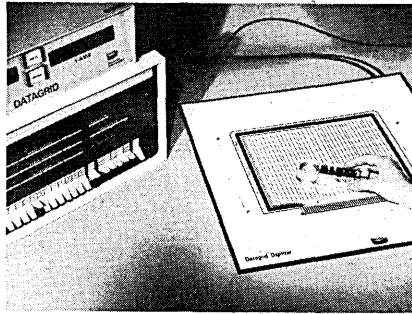

17-inch-square unit can accommodate an 11- x 17-inch drafting sheet. Resolution of the two-dimensional coordinate measuring device is to .01 inch and accuracy is to plus or minus .01 inch. Tracing is done with a free-moving

cursor which has no mechanical linkages. Standard tablet with interface is \$4,970. Datagraph is a smaller version of the firm's 60-inch-square Datagrid at \$33K. BENDIX CORP., Southfield, Mich. For information:

CIRCLE 330 ON READER CARD

### acoustic couplers

Peripherals capable of phone-line communication may be linked to the computer with DATACUPLE, an acoustic coupler that transmits in either full or half duplex modes at rates up to 300 baud. The Model 300 operates in originate mode only and is priced at \$500. Model 300A, at \$600, operates in both originate and answer modes. Loop test, Direct Data Access, and up/inverted code options are available. VANGUARD DATA SYSTEMS, Irvine, Calif. For information:

CIRCLE 332 ON READER CARD

### mag tape subsystems

A series of IBM-compatible magnetic tape systems, including transport, electronics, interface-controller, software drivers and diagnostic, and cables, is being offered for use with small- to medium-size computers. Price range for complete subsystems is \$11,500 to \$18,590.

Data transfer rates to 60kc may

# Close the communications gap in three easy volumes.

Unless you've hired a good systems designer, putting together a data communications network can be like working a jigsaw puzzle. Except that you've got a pretty big gap to fill, and there's no guarantee that the pieces will fit. One wrong decision here could cost you plenty.

Sure, you can obtain manufacturers data and spec sheets on everything from teleprinters to multi-line controllers. But will you be able to justify expenditures, meet all objectives, and still stay within your budget limitations?

AUERBACH Data Communications Reports, a widely recognized authoritative source in this field, can help you not only choose the right components for your system but operate them at top efficiency. Its publishers have no axe to grind because their product is information, not hardware. Objective, factual, current information in its easiest-to-use form.

Key sections prepared by AUERBACH's data communications experts and updated bi-monthly in this three-volume looseleaf service include:

- Communications Systems Design
- Terminal Equipment Reports
- Facsimile Equipment Reports
- Processing Equipment Reports
- Common-Carrier Facilities
- Comparison Charts on over 400 pieces of equipment

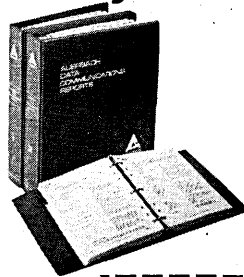

If having the facts to be well-informed in data communications technology is worth anything to you, it's worth the low subscription price.

Start closing the communications gap now by returning this coupon for full details.

**AUERBACH Info, Inc.**  
121 North Broad St.  
Philadelphia, Pa. 19107 (215-491-8400)

  
**AUERBACH**®

Please rush further information on AUERBACH Data Communications Reports.

Please send brochure on all nine AUERBACH information services.

Name \_\_\_\_\_ Title \_\_\_\_\_

Company \_\_\_\_\_ Phone \_\_\_\_\_

Street \_\_\_\_\_

City \_\_\_\_\_ State \_\_\_\_\_ Zip \_\_\_\_\_

DC-102

CIRCLE 179 ON READER CARD

# Oxide disk packs are obsolete.

## DISCOM did it. With nickel-cobalt.

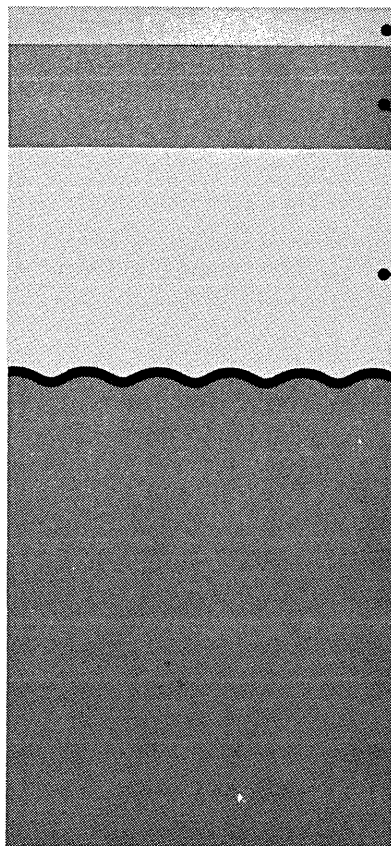

Even the color is different. The whole concept is different. From the surface to the substrate.

- A tough protective overcoat — practically wear-proof. When wear eventually occurs, only this nonmagnetic coating is affected, not the recording surface. No magnetic particles to bunch up, cling to vital metal parts and cause wear, disk abrasion and errors.

- A precision electroplated nickel-cobalt magnetic film. Our exclusive Polar Plating process, done under Class-10,000 clean room conditions.

- An undercoat of electroless nickel (nonmagnetic).

- A controlled texture on the aluminum substrate's surface, so heads will fly with the desired aerodynamics.

What's it all mean? A disk pack fundamentally better than the conventional ferric oxide one. Better in trouble-free operation and long life. More efficient use of your major investment in computer hardware, software and people. Peace of mind for you and savings for your company.

DISCOM nickel-cobalt disk packs are priced comparably with most of the ferric oxide ones. Middle-of-the-road prices for top-of-the-line quality.

Available in error-free and other quality classifications to suit your application requirements and your budget.

Completely compatible, mechanically and electromagnetically, with IBM and compatible drives for the six-high (1316) and 11-high (2316) disk packs, of course.

If your DISCOM representative hasn't been to see you yet, write or phone collect for more information on how this fundamental advance in disk packs can benefit you.

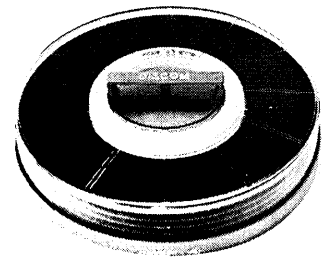

### DISCOM INCORPORATED

2646 N Greenfield Rd | Mesa, Arizona 85201 | Phone (602) 964-2981

*A Subsidiary of Talley Industries, Inc.*



## new products ...

be achieved with 7- and 9-track formats with 200, 556, and 800 bpi densities and speeds to 75 ips. Features include lateral parity, program selectable even or odd parity on 7-track systems, read-after-write heads, and LRC and CRC check characters. Models 2914 and 2914S controllers service up to four transports and execute 19 operations, including read-file, without stopping between records. Other models in the series are the 2906 and 2925. DACONICS, Sunnyvale, Calif. For information:

CIRCLE 329 ON READER CARD

### merchandise tag reader

The first product of this new company is a device that reads retail tickets marked with a new font, called Binar, that is as easy to read, it is claimed, as MICR characters. The numerals can be printed in any size and used on any information source. The Binar Reader is placed on the sales desk in a store department. When a sale is made, the merchandise tag is placed in the slot of the reader, and the information on the ticket is transferred to a tape cassette that is part of the reader. The tape

used can hold as many as 150K characters. At the end of the day, or week, the tape is put through a converter for transfer onto computer-compatible tape or directly into computer memory. The system is said to provide 100% recovery of sales information, since no keying in of information is involved. A simple change of the font band on a Monarch printing machine is needed for Binars to be produced on the merchandise tags. The readers lease for \$25 a month, the converter for \$125. One converter will serve many readers. Full-scale production of the readers is expected by April 1. BINARY SYSTEMS, INC., Orinda, Calif. For information:

CIRCLE 331 ON READER CARD

### portable encoder

First product of a 20-man firm founded last year is the Model 75 magnetic tape encoder, utilizing an alphanumeric or numeric keyboard, a 4-inch crt displaying five lines of 20 characters each, a mag tape cassette, and either AC or optional battery power for portability. A pooler converts the cassettes to standard mag tape. The encoder has a cursor position indicator that steps the operator through, and also permits back-stepping if an error is observed; correction is accomplished by re-keying, and the

characters displayed are written on the tape in burst mode. The unit weighs 8.5 lbs. plus an extra pound for the battery, which will provide power for nine hours. The encoder is said to be noiseless. Prices start at \$2195 for the numeric model. Deliveries begin on April Fool's Day. DATA INPUT DEVICES, Cleveland, Ohio. For information:

CIRCLE 333 ON READER CARD

### pdp fft

A Fabri-Tek 1070 Signal Averager, some copyrighted software, and a PDP-8/L result in a new Fast Fourier Transform system which can transform a maximum of 4096 data points into 2048 real and imaginary frequency points, from which magnitude and phase functions can be calculated. The data are first collected with the 1070 signal averager and can have a maximum frequency of 500 KHz when data are sampled at a rate of 1 MHz. Once the data are collected, the fast Fourier transformation is an off-line process and takes approximately 3.5 minutes for 4K of data, 45 sec for 1K of data. The user may also modify the software, which is modular, to suit special needs. Prices start at \$23.6K. FABRI-TEK INSTRUMENTS, INC., Madison, Wis. For information:

CIRCLE 334 ON READER CARD

# We'll convert you...

You'll have a better EDP operation for it.

**The Austin S/360 LIOCS Simulation System lets you convert from 1400 disk to S/360 operations . . . easily, economically, efficiently.**

- Lets you start writing in the latest programming languages.
- Lets you use all the facilities of DOS and the advanced IOCS techniques . . . key search, sequential work files, etc.
- Lets you convert programs one at a time, at your leisure, and will not have to be rewritten when the file is converted.

The Austin S/360 LIOCS Simulation System is a complete software system — ready to use. For more details, contact



CIRCLE 110 ON READER CARD

BUY  
SELL  
LEASE

# IBM 1401's 360's U.R.

PHONE, WIRE OR WRITE YOUR REQUIREMENTS

**DATA ENTERPRISES INC.**

2710 AVENUE E. EAST  
ARLINGTON, TEXAS 76010  
817/265-1346

CIRCLE 193 ON READER CARD

# Now, a Disk Memory Drive, less than \$3,000.\*

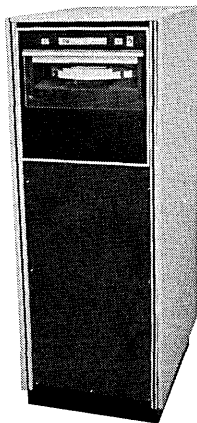

A good Disk Memory Drive doesn't have to be expensive.

We're producing and delivering single-disk, removable-media, disk drives to major computer manufacturers at prices that are an industry breakthrough.

These disk drives, which utilize the IBM 2315 disk cartridge or equivalent, are built to meet the needs of the mini-, small-, and medium-size computer manufacturer. Conservative design and rigorous testing

ensure ultra-reliable and consistent performance.

So if you spend more than \$3,000 for a single-disk memory drive, you'll spend too much... a Disk Memory Drive doesn't have to be expensive to be good.

For further information and complete specifications, contact Jim Flynn at Computer Memory Devices, Inc., 5170 West Bethany Home Road, Glendale, Arizona 85301. Phone (602) 939-9444.

\*In OEM quantities.

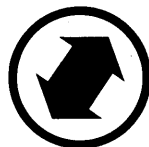

## Computer Memory Devices, Inc.

5170 West Bethany Home Road, Glendale, Arizona 85301

# 15 nano-second memory...

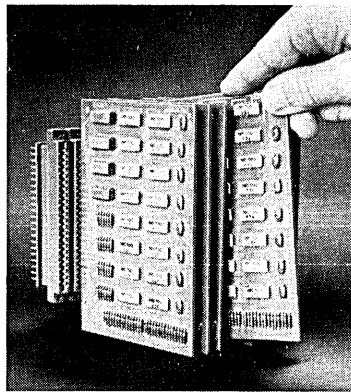

## there's a lot behind it

For one year we have been quietly mobilizing the industry's most capable semiconductor memory team. Personnel from all disciplines to design, assemble, test and volume produce the fastest, most reliable memory systems.

Here are the results:

1. Our memories are the world's fastest —15 nsec. access and 10 nsec. cycle times.

2. Our designs are pre-evaluated and optimized by computer simulation.

3. Our chips are individually packaged in proven, low-cost, ceramic Dual-In-Line packages and mounted on standard P/C cards.

4. Our cards are fully functional and incorporate our own logic support circuits to enhance system performance and minimize overhead circuit requirements.

5. Our quality is verified every step of the way by computerized testing that performs up to 5000 tests/sec. on the chip, the packaged devices, and the modular assemblies.

6. We are now in production.

We design our memories to be modularly expandable and we supply them in ECL and TTL compatible configurations. Our products reflect total capability...The kind of capability that puts a lot behind us, including the competition.

Our first series of modular cards is now available. To order:

	Price: (1 to 9)	ECL Compatible	TTL Compatible*
32 x 8	\$768.00	AMS 0328E	AMS 0328T
32 x 9	\$845.00	AMS 0329E	AMS 0329T

\*Delivery on TTL—one month.



ADVANCED MEMORY SYSTEMS, INC., 1276 HAMMERWOOD AVENUE, SUNNYVALE, CALIFORNIA 94086, TEL. (408) 734-4330

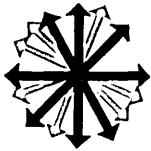

# new software

## **bal debugging**

A new command language, BAL-FIX, is said to enable a programmer to perform interactive debugging of BAL programs on any System/360 under DOS with minimum 32K core. The programmer can interrupt the execution of his program at predetermined locations and selectively display the contents of registers, control words, and core locations. On the basis of this analysis, he can continue execution to the next program interrupt point and modify the contents of any register control word or core location or program additional interruptions. Each BAL-FIX command has a range of error messages associated with it; the appropriate message is printed out on the console typewriter whenever a syntax error is made in a command, or when an unrecognizable command is entered.

BAL-FIX is said to be completely compatible with the DOS supervisor. The package comes as a card deck. Only one additional card is required at the beginning of the deck for a problem program. This card includes parameters which allow the pre-setting of up to ten program interrupts at any desired locations in the program, eliminating the need to insert program checks in the deck. However, any check will also activate BAL-FIX. Price is \$1500. PDA SYSTEMS, INC., New York, N.Y. For information:

CIRCLE 269 ON READER CARD

## **360 t-s extended**

IBM has extended System/360 time-sharing capabilities with two new t-s program packages. The first, called Interactive Terminal Facility, provides t-s for the first time for the 360/25, and also operates on larger models including the 195. Up to 31 terminals can operate concurrently under ITF, using either BASIC or an interactive subset of PL/I. ITF, which runs under either DOS or OS, provides t-s concurrent with batch processing. It can run on a 360/25 with 49K bytes of main storage, supporting 12 terminals. For concurrent t-s and batch processing under DOS, however, a Mod 30 or larger with at least 65K is required; under OS, 131K is needed. The ITF packages use the 2741 communications terminal.

The second package, called Time-Sharing Option, is for System/360 Mods 50, 65, 75, 85, and 195; it also

provides t-s concurrent with batch processing, and additionally accommodates seven different languages. TSO operates under OS/360 MVT and handles any language supported by this operating system, as well as ITF BASIC and interactive PL/I.

Ten new program products will be available for use with TSO: Two terminal-oriented languages—FORTRAN IV (G1) and ANSI COBOL Version 3 (formerly USAS1); three problem-solving languages—ITF PL/I and ITF BASIC, and Code-and-Go FORTRAN (a modified FORTRAN that accepts both free-form as well as fixed-form statements and has simplified I/O statements for terminal use); FORTRAN IV Library (Model 1), an extended version of the OS/360 FORTRAN IV library that provides programmers with a set of subroutines for I/O functions; "Prompter" programs for the Assembler (F), FORTRAN, and COBOL processors, designed to simplify the use of language processors at the terminal; and TSO Data Utilities—four functions for data manipulation (COPY, FORMAT, LIST, and MERGE).

TSO runs on 360/50's and up with minimum 512K main storage for concurrent t-s and batch processing. For either t-s or batch processing, 384K storage is adequate. TSO can use either the 2741 terminal or the printer-keyboard of the 1050 data communication system.

As an enhancement to OS/360, TSO is available at no charge. All other program products will be available under license at monthly rates: ITF with one language (BASIC or interactive PL/I), \$120, with second language an additional \$60; FORTRAN G1, \$65, FORTRAN Library, \$65; Code-and-Go FORTRAN, \$275; ANSI COBOL, \$40; TSO Utilities, \$145; and Prompter, \$30. ITF is scheduled for delivery in the second quarter of this year; TOS and its associated programs are scheduled to be available in the first quarter of 1971. IBM DP DIV., White Plains, N.Y. For information:

CIRCLE 270 ON READER CARD

## **data management**

DS/1, whose \$350/month basic monthly lease price is said to make it the least expensive interactive data management system available, operates on an IBM 360/30 or up with at least 32K core, under DOS, using either 2311 or

2314 disc storage. It operates with existing machine-readable data and extends current uses of the data and equipment. DS/1 accepts typed commands and responds in standard English phrases, so the user need not know computer programming to retrieve data. File security protection is incorporated in the system.

The system permits the user to update information in his data base from the terminal and to check for errors in inputs to the data base. The user can count how many entries in the file meet criteria he specifies at the terminal, print the entire contents of the qualifying entries, or print selected information in any order he desires. SYSTEM DEVELOPMENT CORP., Santa Monica, Calif. For information:

CIRCLE 271 ON READER CARD

## **meta report generator**

The process of generating files or editing files or generating reports or searching out and printing specific data items is so easy using AKSESS that the example problems begin on page three of the instruction manual. The inquiry and file manipulation language is English, and if the user's vocabulary is bigger than the program's, then the program uses whatever parts of the inquiry it understands and will still probably deliver good output in a few seconds.

There are two parts to the program, one for generating an on-line file maintenance and information retrieval system from a user-defined file structure, and an off-line file maintenance generator which allows the use of existing files for creating and maintaining the on-line information.

Once the data element associations and file structures have been described, experience (on a Burroughs 5500) has shown that the program will respond to inquiries, with answers, in about a second. Because of its speed and ability, and the fact that it is written in COBOL, a buyer might expect to dedicate a good deal of core space to AKSESS, but the program uses only about 4K words.

Written for the Burroughs 5500, the \$25K parameter-driven program can be readily converted, but the vendor may find a relatively untapped market for Burroughs-oriented software since few agencies that we know are writing for that equipment. RESPONSE TECHNOLOGY, INC., Seattle, Wash. For information:

CIRCLE 272 ON READER CARD

## **pert plotting**

Release Two of EZPERT is 30% faster and twice as precise as the previous version. The program works with whatever PERT TIME system an installation is using and automates the pro-

## new software...

duction of PERT networks by digital plotter. Written in a hardware independent FORTRAN subset, EZPERT requires 90K core and is operational on IBM, CDC, Univac and Burroughs computers and on Computer Industries, CalComp, Stromberg DatagraphiX, and Information International drum and microfilm plotters. Both event and activity oriented networks may be plotted. By high-speed drum plotter, the new EZPERT is said to be 40 times faster and cost one-ninth as much as manual drafting, and by microfilm plotter, 4000 times faster at one-twentieth the cost. Basic EZPERT price is \$24,550 for a perpetual license. The two dozen plus optional features can bring the cost to around \$50K. SYSTONETICS INC., Anaheim, Calif. For information:

CIRCLE 273 ON READER CARD

### statistics

ALLSTAT, or All Purpose Statistical Package, contains its own input routines for building a file on disc and a monitor system that controls the sequence of mathematical data transformations and statistical analysis operations. The library also includes one- and two-way analysis of variance, Chi-square testing, least square approximation, multiple regression, factor analysis, correlation matrix techniques, and scattergram techniques. In addition, provision is made for adding user-supplied techniques to the ALLSTAT library. No programming knowledge is assumed on the part of the user; an array of prompting and error messages are included. ALLSTAT runs on Systems/360 with minimum 32K core. It's written in FORTRAN and BAL. Price is about \$8.5K. PDA SYSTEMS, INC., New York, N.Y. For information:

CIRCLE 277 ON READER CARD

### os/360 mvt accounting

The objective of Accountpak is to solve the problem of how to charge for individual jobs that are run simultaneously under os/360 MVT. Billed as a "system usage measurement package," Accountpak measures a job's individual use of system components such as cpu, channels, and discs. The system controls the sequence with which tasks are dispatched to the cpu, resulting in fewer system blockages caused by cpu-bound jobs, for a claimed increase in productivity of up to 20%. Accountpak itself adds an elapsed time increase of about 1.5% to processing time on individual jobs, however. It is implemented as an extension to os/360 and may be used in parallel

with existing job accounting routines. No job control statement changes are required in the job stream. Should the need arise, the program may be disconnected from os at the console, to ensure maintenance integrity of os.

The system is activated by the operator, who initializes it at the beginning of an accounting period with a start command, and thereafter it is automatic. Additional programs are available at no extra charge to print out bills. Accountpak is written in assembly language and requires a minimum 20K core. It operates either with or without the HASP I/O scheduler. Lease includes installation, documentation, and main-

tenance. One-year lease, \$12K. Thirty-day free trial requires \$1K refundable deposit. SYSTEMS DIMENSIONS LTD., Ottawa, Ont. For information: CIRCLE 275 ON READER CARD

### 1400 programs to cobol

The latest version of UPGRADE, a translating system which converts 1401, 1440 and 1460 programs to COBOL, features a pre-translation step and other programming aids that now allow the vendor to guarantee complete translations against (customer-supplied) predetermined benchmark data for between \$.75 and \$1 per source card. Previously, a final checkout pro-

**"It's embarrassing  
to tell people that our source  
data collection system  
is so simple and so flexible  
that one system does every  
kind of source data input  
and retrieval job**

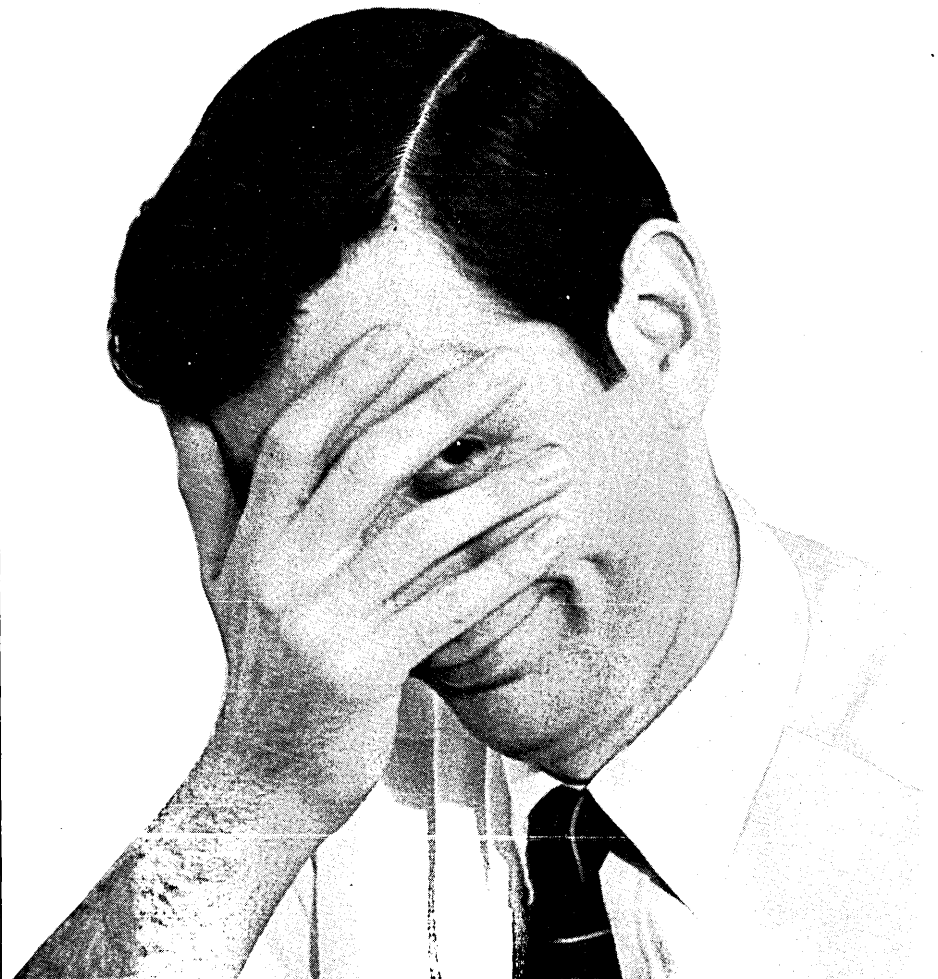

gram cost between \$1.05 and \$1.25/COBOL source card. Then, for 4¢/source card, IMI will replace all data and procedure names generated by UPGRADE with names of the customer's choosing, using the MAGIC COBOL shorthand program. INFORMATION MANAGEMENT INC., San Francisco, Calif. For information:

CIRCLE 274 ON READER CARD

### 3-d contouring

Depending on its buyer, CONTOURPLOT may find itself used for purposes ranging from straight topographical mapping, to high intensity wave beam

analysis, to statistical surface fitting to pure math modeling. The FORTRAN IV program provides engineers and mathematicians with a software interface to drive plotters and options to configure that interface to handle their specific needs.

The base program requires a machine with at least 16K words of core, but, in keeping with Parkinson's Law, expands to fill the available space. It is sold on a one-time lease basis with small payments for lease renewal. A price of \$8500 brings the CONTOURPLOT program to a site for three years; thereafter the cost is \$300 every additional three years. A profile plot option

(\$500/three years), isometric option for three-dimensional plotting (\$2500/three years), statistical surface fitting option (\$850), and multi-surface option for plotting unions, intersections, multiplications, etc. (\$2000) are also offered, and some of these can be purchased separately. HOUSTON INSTRUMENT, Bellaire, Texas. For information:

CIRCLE 276 ON READER CARD

### probability subroutines

BETGAM is a package, in the form of a source listing and documentation, of FORTRAN IV function subprograms to provide commonly used probability and statistical functions not generally included in FORTRAN subroutine libraries. BETGAM sells for \$300 and consists of seven functions: BETA (complete Beta function), GAMMA (complete Gamma function), PROBB (Beta probability distribution), PROBC (Chi-square probability distribution), PROBF (F-ratio probability distribution), PROBG (Gamma probability distribution), and PROBN (normal probability distribution). All utilize approximations said to be sufficiently accurate for most purposes. MARKETMATH, INC., New York, N.Y. For information:

CIRCLE 282 ON READER CARD

### input evaluation

The Input-Thru-Put Standard Cost and Evaluation System is a package which measures input productivity by individual operator, by job and machine type, i.e., 026, 029, Univac 1701, etc., and compares them against in-house standards. Buyers of the package will also become subscribers to a monthly newsletter providing figures on national keystrokes per hour input averages, average national error rates, and other information on input devices; eventually, the newsletter will be expanded to include costs and averages by industry and regions. It's written in COBOL, requires 16K bytes for S/360, and is also available for most other manufacturers' hardware. Price is \$300. The package is offered by the Input Data Institute, a division of a year-old firm which is involved in various areas of input service, including input facilities management: INPUT DATA CO., INC., Stirling, N.J. For information:

CIRCLE 279 ON READER CARD

### retrieval and reporting

Pre-printed forms completed by a non-computer expert are translated into control cards for the USURPER I program by a keypuncher and used to

## ...but, it's true!"

Yes! This is the one that does it all — yet a basic Message-ComposeR® System, including items A, E, F, G & I leases for less than \$100 per month. All components are ready for shipment immediately.



- (A) Keyboards
- (B) Automatic Badge Reader
- (C) Tab Card Reader
- (D) Manual Badge Reader
- (E) Solenoid Pack w/Typewriter
- (F) Tone Receiver
- (G) Junction Box
- (H) Audio Tape Recorder
- (I) Master Unit

**Make us prove it!** Simply check the applications your company is interested in, and North will send complete information.

- |   |  |
|---|--|
| <input type="checkbox"/> ATTENDANCE REPORTING<br>Use components E, F, G, I, B | <input type="checkbox"/> INVENTORY CONTROL<br>Use components E, F, G, I, A       |
| <input type="checkbox"/> JOB REPORTING<br>Use components E, F, G, I, A, B, C  | <input type="checkbox"/> RECEIVING/INSPECTION<br>Use components E, F, G, I, A, C |
| <input type="checkbox"/> OTHER _____  |  |

NAME AND TITLE \_\_\_\_\_

COMPANY \_\_\_\_\_

ADDRESS \_\_\_\_\_

CITY AND STATE \_\_\_\_\_

ZIP \_\_\_\_\_



### NORTH ELECTRIC

Electronics Division/Galion, Ohio 44833  
A subsidiary of United Utilities, Incorporated  
For immediate service: call 419/468-8590 or  
TWX 419/464-4860. Ask for Data Products Manager.

CIRCLE 68 ON READER CARD



## new software...

generate reports from information stored on tape or disc files connected to an IBM 360 series computer. In the same manner the user can reconfigure his files, maintain them, or create new ones. The program has two portions, one for compiling the user's English language card statements into an "inquiry list," and one for preparing the reports from retrieved data.

The BAL language package operates under DOS or TOS and is expected to be most useful to installations preparing

mailing lists or working with similar simple lists. It requires 32K bytes of core, and up to two input and two output files. One of its advantages is that the input statements are used to compile good built-in documentation regarding any report generation. Although not nearly as powerful as a MARK IV or SCORE, USURPER I is not nearly as expensive either, at \$5000. The purchase price includes one week of training, but distant customers are expected to pick up the tab for out-of-pocket training expenses. J. TOELLNER & ASSOC., Los Angeles, Calif. For information:

CIRCLE 278 ON READER CARD



It's no dream. Our incredibly low price is absolutely for real. How? Simple. No blue sky over-engineering, no idle parts sitting — and costing — till user requirements catch up. This keyboard display terminal is a completely self-contained, stand alone unit: with keyboard, video presentation, control and refresh electronics, data phone interface, and power supply. Just plug in and you're on line. It's available for immediate delivery. For further details, write for our free brochure or call collect.



Infoton

INFOTON INCORPORATED  
SECOND AVENUE, BURLINGTON, MASSACHUSETTS 01803 (617) 272-6660

CIRCLE 183 ON READER CARD

## source program maintenance

The Source Program Maintenance System stores all source programs on tape, eliminating storage on card decks. Options include full program maintenance, listing of source programs, reproducing up to three source decks, compiling and running from tape, addition and deletion of source programs, resequencing of source programs, and changing program identification. The system runs on 360/30's and up, and handles COBOL, RPG, FORTRAN, and Assembly Language programs. It was developed by the vendor for in-house use, but is now being offered as the firm's first package that is not applications oriented. Price is \$2K. But buy any of the vendor's application packages, SPMS is thrown in free. DELTA DATA SYSTEMS INC., College Park, Md. For information:

CIRCLE 280 ON READER CARD

## analysis & control

Project Analysis and Control stores information on projects being designed and/or programmed by each individual segment of the project. It provides output analyzing the time and cost of each project and segment of a project, including estimated completion dates, cost figures, and flags areas of potential problems. Nine reports are generated, showing departmental loading, program history, programmer efficiency, and total cost for each project and each segment. PAC runs on System/360 with minimum 65K core and disc, and can be implemented with 32K using available pull-down routines. It will be modified for use on RCA and Univac hardware at no charge if there is a demand for at least two packages. Language is COBOL with a few BAL macros. Price is \$7.5K including documentation. INTERNATIONAL SYSTEMS INC., King of Prussia, Pa. For information:

CIRCLE 284 ON READER CARD

## information management

Telecommunication Information Management Executive (TIME) will handle any data bank using any type of IBM-supported terminal devices in any desired combination. The system's modularity provides for a step-by-step expansion from simple inquiry to a comprehensive management information system.

TIME will run on an IBM 360/25 or up under OS or DOS and has been implemented with multiple terminal devices and applications in less than 32K of memory. Processing modules may be either transient or core resident, and memory requirements vary with the number and type of terminals.

Present operational terminal support includes IBM's 2260 crt, 1050 data communications terminal, and 7770 audio response, but modules to support additional terminal types can be added. According to the vendor, the design concept is valid for all terminal oriented third generation hardware and could easily be converted to run on other manufacturers' equipment.

The program TIME is file and terminal independent—application modules may be written free of file or communications considerations—so the system is also application independent. The application modules can be written in COBOL or FORTRAN, as well as in assembly language (in which the system operates).

TIME is being offered for between \$10,000 and \$18,500 depending on the terminal control modules required. The user receives full documentation, and all application processor interfaces are defined to the programmer. In addition, four weeks of on-site implementation support and systems tailoring is provided. SHAW SYSTEMS ASSOCIATES, INC., Houston, Texas. For information:

CIRCLE 281 ON READER CARD

#### **maintenance**

General Maintenance System creates a range of edit and update programs,

including file creation, transaction editing, file maintenance, and optional audit-trail and/or error routines. The programs are created for each file by the CMS "generator" and all are in COBOL, with provision for incorporation of unique individual user routines. Features include: add or delete records; add to, subtract from, or replace fields; creation of I/O and transaction-type record counts; old, new, and changes in balances for user selected fields; print or punch error transaction images; and printer, punch, tape, or disc output. Minimum hardware configuration is a 32K System/360 os or dos, reader/punch, printer, disc drive for system residence and one additional direct access device or four tape drives, or equivalent COBOL support configuration. CMS price is \$5K. INFORMATION SCIENCE INC., New City, N.Y. For information:

CIRCLE 283 ON READER CARD

#### **payroll**

A payroll system previously used by the vendor as a service and marketed only in the New York metropolitan area is now available nationally for users of 360/30's and up. It features flexible reporting of regular time, overtime, shift premium, and up to ten company-defined payments. Labor distribution, multiple checks, and

other reports are generated. The system is sufficiently modular to accommodate various types of firms and service organizations and includes more than 20 programs written in assembly language. Minimum configuration is 32K dos. Price of \$5350 includes source programs, user manual, and documented operations manual. Free installation is provided in the New York City area, with an extra charge elsewhere if installation assistance is required. COMPUTER PROCEDURES CORP., Valley Stream, N.Y. For information:

CIRCLE 285 ON READER CARD

#### **proof & transit**

PAT's a proof and transit system intended for non-dedicated use in medium-sized banks. The program presently handles about 100K items per day in less than two hours of processing for the developer, Second National Bank of New Haven. The system uses one 28K partition of a multiprogrammed 360/30 with a standard printer and a table of sort and float patterns. In addition to deposit and batch proof, PAT captures cash letter data for all end points on the initial pass; rerun passes are only needed for physical transit separation and require only 15K of core.

(Continued on p. 224)

# Computer Companion

## # 788

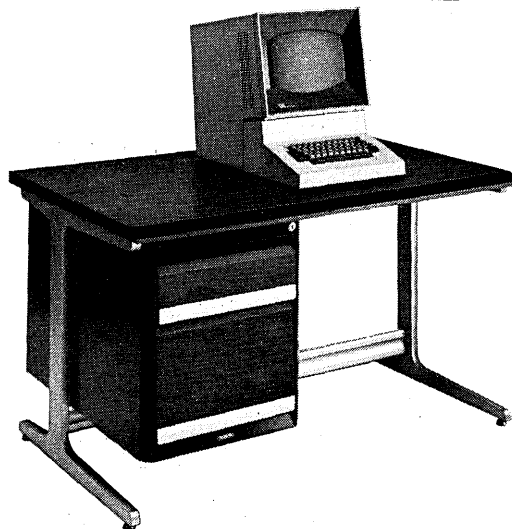

New Tab Data Display Desk. Who says optimum function and versatility have to mean "ugly"? Slim, strong series 500 Data Display Desks have cantilevered aluminum frame that dresses up with optional two or three drawer pedestals. Walnut top with black trim

or light grey formica with dark grey trim. Desk top and front edges are beveled to protect shins and elbows. 45" and 62" models in calculator and desk heights. Ideal for CRT units, microfilm readers, or whatever you want done with style and efficiency.

**TAB**  
PRODUCTS CO.  
2690 Hanover Street  
Palo Alto, California 94304

## new software...

The program accumulates float data and deposit items for account service charge analysis, writes master and batch proof lists with detail lists for each sort pocket, and automatically writes cash letters. A clear audit trail is provided to trace a transaction through the system. An interrupt system, whereby operation can be stopped voluntarily at any time without losing information or destroying files, allows higher priority processing to interrupt the system or low volume proof and transit work to be done on a demand basis. Disaster routines protect against power failure, so only the current run need ever be rerun. The language is BAL. The price is \$15K. CULLINANE CORP., Boston, Mass. For information:

CIRCLE 286 ON READER CARD

### double-precision apt

Latest standard release of APT III (Version 9) for the Univac 1108 is now available with double-precision Section II (Arelem). Univac says it has found that although single-precision computation gives satisfactory results in nearly all cases and, of course, costs less, parts that use in their definition

quadratic surfaces with large dimensions sometimes fail in single-precision. Few part programs that fail in APT do so because of the precision of computation, however, so recourse to double-precision should be used with discretion. The double-precision APT system tape is available to 1106/1107/1108 installations. UNIVAC, Philadelphia, Pa. For information:

CIRCLE 287 ON READER CARD

### shared lab info

The Shared Laboratory Information System is intended to reduce clerical work in hospital laboratories and speed clinical test reports to doctors. It organizes doctors' orders for tests, validates the results, and directs the computer to print test reports and post charges to patient accounts. The program can be used by a single hospital or by several hospitals sharing a central computer. In a shared system, each hospital would use its own test procedures and would have access only to its own information.

Hospitals can tailor the system by putting their individual requirements into a master file that the program would use as a reference for clinical test procedures and report formats. About 20 types of reports can be produced, including a monthly statistical analysis of all lab test results and daily

summaries. The program is compatible with IBM's Shared Hospital Accounting System and operates with standard SHAS executive routines. Shared Laboratory Information System operates on System/360 Mods 25, 30, 40, and 50, under DOS with minimum 32K core. It is written in COBOL with some assembly language. The program is scheduled to be available in the third quarter at \$250/mo. under license. IBM DP DIV., White Plains, N.Y. For information:

CIRCLE 288 ON READER CARD

### reporting

The Simultaneous Reporting System consists of three parts—one which edits a series of English language inquiry cards and builds an inquiry table, one which uses the table to retrieve needed records from tape or disc files, and one which sorts the retrieved records to produce output. A "programmer" intending to produce a report writes out his report requirements listing headings, data fields, computations to be performed, etc., in commands that sound like "SELECT RECORDS" PART NO. EQUAL TO or something similarly easy. The system goes from there to the sequential files and produces up to 40 output files in shape for printer or card punch.

SRS is written in IBM 360 assembler

# SCANNABLES

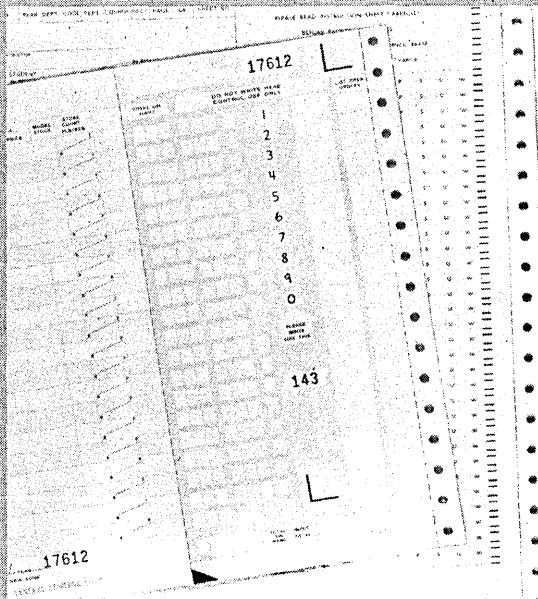

## INCREASE DATA INPUT EFFICIENCY

OCR and OMR input documents must be precisely made for maximum throughput efficiency, GAF has the know-how, materials and quality control to assure user savings. Our OCR specialists are experts in designing input forms of every type plus "turn-around" documents for every application. Insist on GAF Business Forms for total reliability.



**GAF Corporation**  
**Office Systems Division**  
**Business Forms**

40 High School Avenue  
Shelby, Ohio 44875  
Telephone (419) 342-3515

A-5068

CIRCLE 161 ON READER CARD

## new software...

language, requires 44K bytes of core and two tape drives, runs under DOS or OS, and operates on one input file. The program is expected to be used where report formats change often and there is insufficient time to sit down and reprogram from scratch (which is about everywhere). The one-time "lease" price is \$12K, which includes installation and a year's maintenance. SINS may be rented for \$150/month, not including maintenance, after a \$1K installation charge. CHILTON COMPUTER CO., Dallas, Texas. For information:

CIRCLE 290 ON READER CARD

### numerical control

Americans are being given a chance to join EXAPT, a non-profit organization of numerically controlled tool users who share the program of the same name. The association is the European counterpart of Illinois Institute of Technology's APT association, but their automatic parts tooling programs are different. The IIT APT program is designed for continuous path tooling on three to five-axis machines. The EXAPT program, on the other hand, is in-

tended for less complicated parts programming on two-axis machines (particularly drills and lathes) using point to point tooling methods. However, the EXAPT program is capable of selecting tools, tool speeds and feed rates, and even determining the sequence of cuts for the programmer.

Membership in the association—and a copy of the program comes with every membership card — costs the average member a \$6200 initiation fee and \$3100 per year thereafter. The association is represented in the U.S. by a single source that provides training, documentation, and conducts annual meetings. SYSTEMS, SCIENCE, AND SOFTWARE, La Jolla, Calif. For information:

CIRCLE 291 ON READER CARD

### library system

Automated Library Processing Services, ALPS, which is especially suitable for maintaining centralized records for large library systems and networks, provides catalog cards, book-form catalogs, special bibliographies, and circulation control. The ALPS program automates bibliographic search and retrieval using records distributed through the Library of Congress Machine-Readable Catalog (MARC) tape program for access to all recent Eng-

lish language works. ALPS also contains in-process records for each library, allowing them to determine the location and status of recently ordered or acquired books. The system can extract data from its files and analyze it for management needs.

ALPS is being offered on a time-shared basis from SDC's Santa Monica and Falls Church (Va.) facilities, and requires no knowledge of computer programming on the part of the librarian, who can enter instructions and receive answers from the computer via a teletypewriter terminal. Or results may be printed out for later delivery to the library. Training and consulting services in the use of the system will be provided if needed. Basic ALPS service begins at \$100 a month.

The on-line ALPS programs are written in JOVIAL; the off-line programs in PL/I. The system will run on a 512K IBM 360/50 or /67. ALPS may be purchased, but the user cannot buy the right to reproduce it. So far, the only purchase price that has been decided upon is \$6400 for the circulation subsystem. ALPS is currently running on an experimental basis in five Southern California libraries. SYSTEM DEVELOPMENT CORP., Santa Monica, Calif. For information:

CIRCLE 289 ON READER CARD

# IDS Disc Memory Systems & Controllers Interface with most Mini-Computers

**Off-the-shelf availability! In production quantities!**

In addition to available compact and reliable Model 7000 and 8100 series disc memory systems, IDS now offers a new line of controllers—expandable in increments of 32K words—accommodating up to eight IDS memory systems.

Ideal for mini-computer and medium capacity digital equipment applications, IDS memory systems include all necessary read/write IC electronics at lowest-per-bit cost.

Disc files are available within 30 days of order; Controllers based upon specification requirements.

### IDS System Capabilities and Features

- reliability—only one moving part
- minimum access time with fixed, non-positioning heads
- no head to disc contact—even at *Start* or *Stop*

INFORMATION  
**IDS**  
DATA SYSTEMS INC.

Write today for interface specifications, application notes and controller specs.

8260 E. Eight Mile Road, Detroit, Michigan 48234 • Phone (313) 891-2400

CIRCLE 164 ON READER CARD

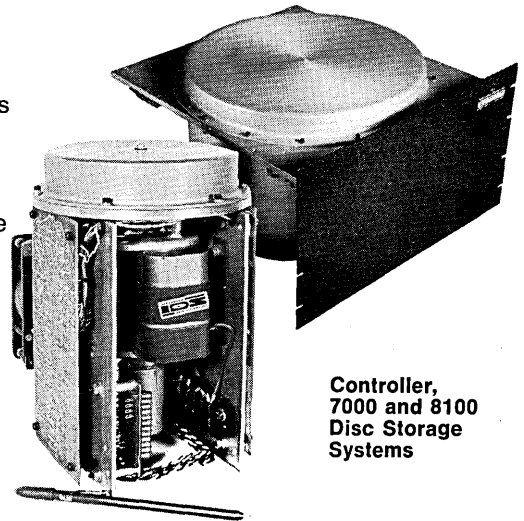

Controller,  
7000 and 8100  
Disc Storage  
Systems

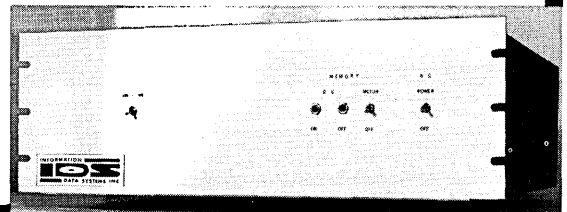

There are a lot of software companies around who have made compilers. One here. Two there. Maybe, if you count the little one that didn't work too well, three. But Digitek is the commanding leader of the compiler business. We've written more compilers than any other software company. Something like fifty-five at this writing. We've written compilers for almost every major language and for some minor ones. We've written big ones and little ones,

**DIGITEK**

fast ones and not so fast ones, expensive ones and inexpensive ones. So when you need a compiler, go to the company that knows its way around. Digitek. And if you need some references, ask the man who owns two.

*Digitek has just completed an easy-to-read, easy-to-understand USA FORTRAN Manual. It's yours, free, just by writing Digitek. On your company letterhead, please.*

4818 Lincoln Blvd., Marina del Rey, Calif. 90291 (213) 823-6361

**Digitek  
makes  
more than  
compilers.  
It makes  
a lot of  
them.**

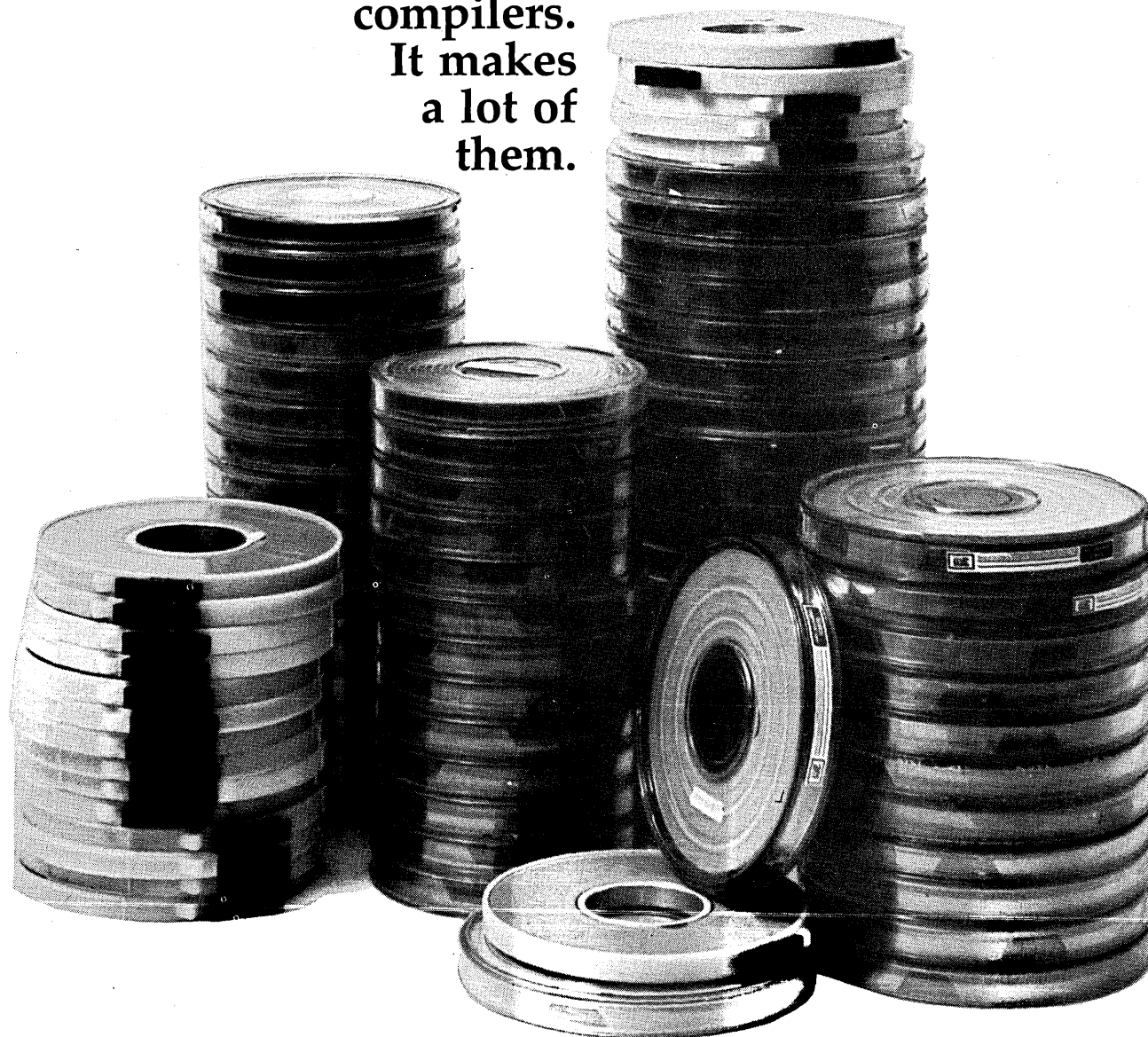

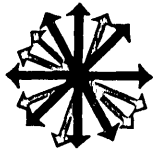

# new literature

**CONNING COM:** Two-color wall chart (22" X 35") gives specifications of Computer Output Microfilm from 18 major manufacturers, including on-line and off-line transmission codes, console parts, controller, cameras available, retrieval codes, particulars on alphanumeric and graphics, magnetic tape and forms overlays. Special on-line features of the various systems are also listed. And the prices—lease and purchase. The chart was adapted from one in the article *Selecting the Right COM Unit* (December, p. 102). Single copies \$1, each additional copy \$.50 postpaid. DATAMATION, 94 S. Los Robles Ave., Pasadena, Calif. 91101.

**PROGRAM LIBRARY:** 14-page brochure describes PLUS program, for maintaining and updating a library on all source programs, enabling their centralization on tape or disc. PLUS is written in COBOL, but any programming language may be stored or intermixed in a library file. The system operates on one-card control, eliminating deck handling. Changes and operations on several programs can be entered at once, and there is an automatic job control setup for compiling. The program comes with user training, 30-day free trial and 90-day malfunction warranty. CULLINANE CORP., Boston, Mass. For copy:

CIRCLE 251 ON READER CARD

**BOOK ACQUISITION:** 16-page brochure describes BATAB, computerized book ordering system for libraries which covers all stages of acquisition, including budget control. Only thing left for the librarian to do is decide which titles to order. The system also is adaptable to synchronizing the main library with different branches or departments. Duplication of orders is prevented, and lists of undelivered titles keep the library *au courant*. Wire service for rush orders is optional. THE BAKER & TAYLOR CO., Somerville, N.J. For copy:

CIRCLE 252 ON READER CARD

**EUROPEAN SOFTWARE:** All proprietary software packages currently being offered in Europe are detailed in a catalog edited by a neutral independent Swiss supplier which also furnishes hardware to its clients. Abstracts are given on each package,

with the hardware and software requirements, documentation, support, and maintenance supplied, costs, and the vendor's address. The catalog is indexed three ways: by package application, by computer system, and by software supplied. The first year's update service (three times) is included in the price: \$45. INTERNATIONAL SOFTWARE SERVICES, P.O. Box 16, Ch-1605 Chexbres, Vd., Switzerland.

**BACK TO THE RESERVATION:** An "Indian Profit Portfolio" in 10 parts gives the names and product lines of more than 60 companies already operating on American Indian reservations, particularly in electronics. The portfolio shows that a minimum of outside supervision is required for native Indian labor. Financial and business incentives offered to manufacturers interested in setting up plants, or assisting Indian organizations to do so, are also

outlined. Case histories describe new operations. A map of all Indian Land Areas in the U.S. (total acreage equals that of all U.S. major cities) is included. NATIONAL CONGRESS OF AMERICAN INDIANS, Washington, D.C. For portfolio:

CIRCLE 254 ON READER CARD

**DISSEMINATION SURVEY:** 100 fact sheets received in response to a systems survey on information dissemination are included as part of results reported by American Society for Information Science to the Army in June, 1969. The sheets are grouped into operational, pilot and planned systems. The survey itself is 150 pages, organized so the reader can easily locate specific design characteristics in detail. Price: \$3; microfiche, \$.65. CLEARINGHOUSE, U.S. DEPARTMENT OF COMMERCE, Springfield, Va. 22151.

**CODASYL REPORT:** The Data Base Task Group of CODASYL (Conference on Data Systems Languages) has released a report of some 200 pages, detailing its proposals for separate and distinct data description language and data manipulation language. Specifications call for data bases which can be processed by any host language,

THERE MUST BE A  
BETTER WAY FOR  
MY COMPUTER  
TO TALK  
TO ME!

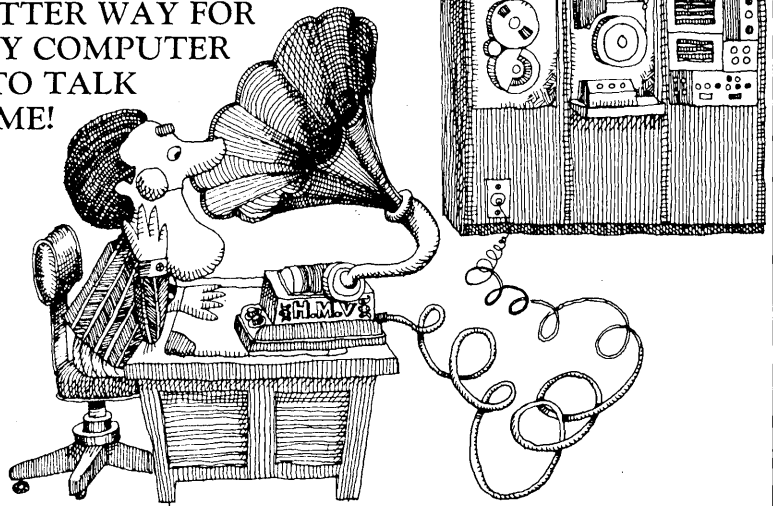

Data entry or retrieval problems such as: credit card verification, real estate sales, insurance programs, bank loans and balances, stock quotations and plant needs such as inventory control, order entry, and routing and distribution can be solved with a Datatrol Voice Response System.

Users can communicate by using a standard Touch-Tone® telephone, card dialer, or special custom terminal. The computer replies with a human voice using words stored in the Datatrol system.

Any telephone can be a computer terminal. Qualified users have efficient and economical access to the computer day and night from any location.

Call or write for more information.

**Datatrol Inc.**

KANE INDUSTRIAL DRIVE, HUDSON, MASSACHUSETTS 01749, 617-562-3422

CIRCLE 180 ON READER CARD



Nothing can print  
so much so fast.

**Litton Datalog's MC 8800—the Ultra High Speed Printer that's not for everyone.**

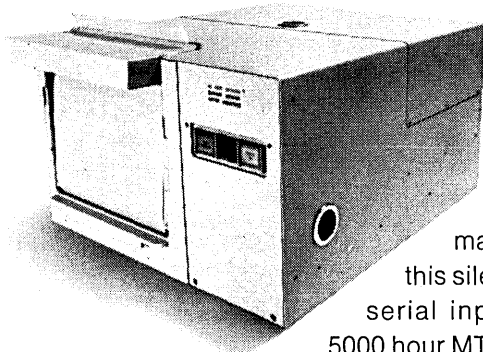

If you need the incredible speed of 6000 lines a minute, 88 columns per line, from any digital source, you must get the MC 8800 — nothing in the world can match it. But along with speed, this silent, non-impact printer offers serial input, modular construction, 5000 hour MTBF and easy computer compatibility as well.

It's a package that's truly unique, truly state-of-the-art. If you need less, take a look at other Datalog fiber optics printers; but if you need unequalled capacity, call us about the MC 8800. Datalog Division of Litton Industries, 7801 E. Belleview Avenue, Englewood, Colorado 80110. (303) 771-2010.

**DATALOG DIVISION  
LITTON INDUSTRIES**

CIRCLE 121 ON READER CARD

**Distributor wanted!**

**COMPACTA 393**

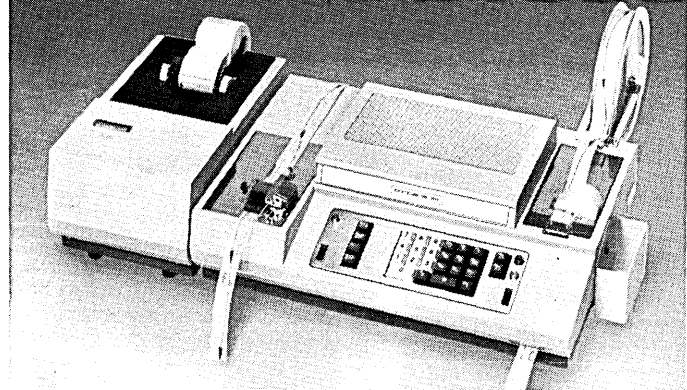

This is a source oriented data gathering machine by means of punched paper tape.

COMPACTA 393 offers the versatile and exciting features by combinations of the tape perforator, reader and adding unit.

More compact, more reliable and more economical than others in its field.

- \* Selective operation
- \* Even or odd parity check
- \* Any function key available
- \* Any code usable

Other models available. For details, please write:

**UCHIDA YOKO CO., LTD.**

1-3, Takaracho, Chuo-ku, Tokyo, Japan Phone: 535-3111 Cable: UCDCOY TOKYO

CIRCLE 166 ON READER CARD

**new literature ...**

provided some additional manipulative features are used. Other CODASYL data management goals also are covered: a variety of access methods to a database, with protection against unauthorized access; a variety of data structures in network structures; flexibility of application without data redundancy. The report is a combined effort of suppliers and major users. Price: \$4. ASSOCIATION FOR COMPUTING MACHINERY, 1133 Avenue of the Americas, New York, N.Y. 10036

**PATIENT BILLING:** Booklet describes Auto-Scribe, billing and accounting service which automatically allots charges to private, Medicare, Medicaid and welfare patients in nursing homes and hospitals. The system already has weathered in for more than a year at several institutions. It does not require expensive equipment or highly-trained personnel. BRANDON/-GAYNES MEDICAL SYSTEMS, INC., Chicago, Ill. For copy:

CIRCLE 253 ON READER CARD

**TIME-SHARING PRIMER:** Time-sharing—past, present, and forecast future—is explained very basically in 12-page booklet. The evolution of more direct communication with the machine is taken step by step, showing the links that were eliminated, the use of compilers and development of languages. Hardware changes needed for time-sharing, i.e., introduction of the communications processor, and software improvements now being made are presented so the beginning student can understand. Diagrams and charts help throughout. CALL-A-COMPUTER, Minneapolis, Minn. For copy:

CIRCLE 255 ON READER CARD

**ISA PAPERS:** Titles of 151 papers from 24th Annual Conference of the Instrument Society of America held in Houston last October are listed in folder. The papers are obtainable in abstracts (of 100-200 words), complete reprints, or compiled from the proceedings. Subjects covered include computers in environmental and process control, design measurement and data acquisition. Prices and numbers for each paper are given, with order form. ISA, Pittsburgh, Pa. For copy:

CIRCLE 258 ON READER CARD

**IN-HOUSE TRAINING:** Four-page brochure describes "System/M" programmer training which can be accomplished in-house. Heart of the system is a student-controlled study booth with

audio-visual instruction components, including stereo tape recorder and 35 mm slide projection. Students can proceed at their own learning pace, and repeat material difficult for them. Educational materials are provided for courses in IBM 360 ALC, FORTRAN, COBOL, PL/I and RPG programming, as well as more basic ones for introduction to systems principles, including System/360, and data communications. INSTITUTE OF ADVANCED TECHNOLOGY, Anaheim, Calif. For copy:

CIRCLE 257 ON READER CARD

**CORROSION CONTROL:** Various types of noxious impurities that can contaminate the computer's environment and render it *kaput* are enumerated in 12-page report. Pollutants and/or toxicants, including hydrogen sulfide, sulfur dioxide, ammonia, ozone, nitric oxide, are evaluated with the action of Purafil (permanganate-alumina) environmental control systems in abating them. An analysis of a typical corrosion problem in a computer facility is given, with diagnosis and recommended procedure for removing contamination. BORG-WARNER CORP., Washington, W. Va. For copy:

CIRCLE 259 ON READER CARD

**RPG'S FOR PDP'S:** Folder describes Report Program Generators for small computers (PDP 8's, 9's, 10's and 15's). Previously used successfully on large general-purpose computers, RPG language can be applied for ordinary but diversified dp tasks such as accounts payable and receivable, inventory control, payroll and sales reports, permitting more versatile use of dedicated computers. The RPG's can be used in stand-alone systems or satellite terminals. CODON CORP., Waltham, Mass. For copy:

CIRCLE 260 ON READER CARD

**AUTOMATION SURVEY:** 100-page booklet details results of 1969 industry-wide banking survey on computer usage. Replies from 3,251 banks reveal plans for automating various operations, use of OCR systems and pre-authorized payment plans. Responses to detailed questionnaires are divided into five categories according to bank size—from those with deposits totalling \$10 million to those with more than \$500 million. Price: \$10. AMERICAN BANKERS ASSOCIATION, Order Processing Dept., 90 Park Ave., New York, N.Y. 10016.

**LARGE BOOK ON MINI'S:** 404-page handbook explains small computers (PDP-8's), their system operation, interfacing, installation and planning. Other chapters (there are an unsuper-

# COURSES FOR SYSTEM MODELING, SIMULATION AND OPTIMIZATION

C.A.C.I. has developed four short courses on the techniques that have been successfully applied, with the help of the computer, to difficult Systems problems.

## SIMSCRIPT I.5\* Modeling and Programming

- Washington, D.C. March 9-13
  - New York April 20-24
  - Washington, D.C. June 8-12
  - Los Angeles July 27-31
- Fee \$300

## GPSS An Introduction to Simulation

- Los Angeles April 28-May 1
  - Washington, D.C. Aug. 25-28
- Fee \$250

## Introduction to the Simulation of Military Systems and Operations

- Washington, D.C. Feb. 25-27
  - Los Angeles Mar. 18-20
  - Washington, D.C. Apr. 8-10
  - Washington, D.C. May 11-13
- Fee \$275

## Introduction to Operations Research

- Washington, D.C. April 13-17
- Fee \$300

- Please enroll me in the courses checked above.
  - Please send me more information on the courses checked above.
- Name \_\_\_\_\_ Title \_\_\_\_\_  
 Company \_\_\_\_\_  
 Address \_\_\_\_\_  
 State \_\_\_\_\_ City \_\_\_\_\_ Zip \_\_\_\_\_  
 \$ \_\_\_\_\_ Fee enclosed  Bill me  Bill my Company

# C.A.C.I.

CONSOLIDATED ANALYSIS CENTERS INC., Dept. D-1  
 225 Santa Monica Boulevard  
 Santa Monica, Calif. 90401 (213) 451-5771  
 Washington, D.C. Offices: 1815 No. Fort Myer Dr., Arlington, Va. 22209 (703) 527-8012  
 \*Trademark and Service Mark of C.A.C.I.

CIRCLE 156 ON READER CARD

# For one-of-a-kind scientific applications, look to Raytheon Computer.

## The Palomar Observatory did.

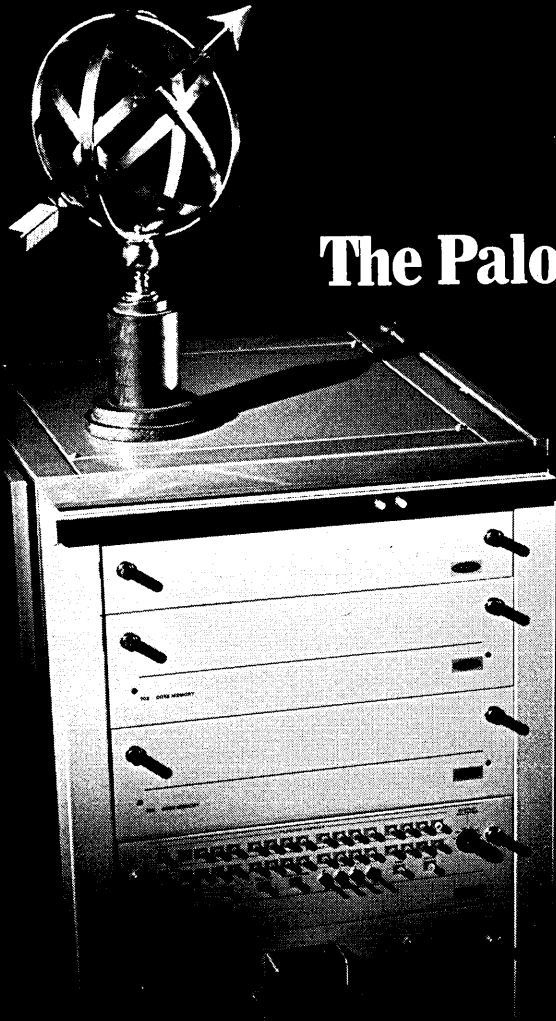

To make observations more accurately, they selected one of our 16-bit computers for controlling the motion and position of their 200-inch and 60-inch telescopes, acquiring data and performing quick-look data reduction during the observations.

Choose a Raytheon computer for *your* stand-alone systems and you'll upgrade performance the same way.

For starters, we'll get you on-line sooner. Because we have more than 400 debugged, proven programs and subroutines available off-the-shelf. Including executives and monitors, conversational FORTRAN in 4k, and the fastest, most accurate math library in the medium-scale computer class.

We'll give you any of the standard peripherals you want. Cards, paper tape or mag tape. Line printers, plotters or discs.

Or we'll interface to any non-standard equipment you need. DVM's or spectrophotometers. Analog or digital. Data processing or process control. With our instant interfaces, our computers will talk to anything you have.

And we let you make your cost/performance trade-offs right in the Raytheon Computer family. Take your choice of CPU's with cycle times from 900ns to 1.75 $\mu$ s, prices from under \$10,000. All with direct I/O to the CPU, 4 addressable registers and 74 instructions.

So write for all the details now. Ask for Data File CB-179. There isn't a better price/performance story in the industry.

Raytheon Computer, 2700  
S. Fairview St., Santa Ana,  
Calif. 92704. Phone 714/  
546-7160.

**RAYTHEON**

## new literature ...

stitious 13) cover I/O equipment instructions and facilities, basic programming, data break, internal operations, programmed data transfers and digital logic circuits. All followed by appendices with pertinent codes and tables, to the powers of two. DIGITAL EQUIPMENT CORP., Maynard, Mass. For copy:

CIRCLE 261 ON READER CARD

**PROGRAMMER CUBICLES?** Eight-page brochure illustrates and describes free-standing office modules that can be tailored to fit individual job functions, including one planned for programmers. The units can be grouped, modified or moved as requirements change—even to a new location. They are available with built-in furnishings and fixtures, which also can be varied to suit the occupant. Wall paneling comes wood-grained or in solid color. DEXION INC., Woodside, N.Y. For copy:

CIRCLE 262 ON READER CARD

**TIME ON ITS HANDS:** Computer time available in major cities coast to coast is listed in 36-page quarterly, *Computer Time Report*. The magazine is a clearing house for brokers, centers and individual companies with idle intervals. Configurations, prices and time schedule advice is given, with suggestions to both buyers and sellers on services in demand and efficient use of time. General market trends and developments are also briefly analyzed. TIME BROKERS, INC., New York, N.Y. For copy:

CIRCLE 263 ON READER CARD

**MEDICAL COMPUTER CAREERS:** Nineteen medical-computer occupations are described in booklet, *Occupational Analysis of Computers in Medical Sciences*. Jobs range from PhD's to clerical, with the prognosis that in the medical field "the use of computers will continually expand the variety of occupations in the next few years." It offers a specific hope of getting in through the back door to those with limited education who wish to get into medicine but cannot otherwise meet the stiff economic and scholastic requirements. Price: \$.45. U.S. GOVERNMENT PRINTING OFFICE, Superintendent of Documents, Washington, D.C. 20402.

**SOFTWARE PACKAGES:** Three software packages—Payroll, Money-Minder, and Facilities Management—are explained in 10-page brochure. The payroll system is used by 21 of the 50 leading U.S. banks. Money-Minder, an income and

expense reporting system, operates in conjunction with a regular checking account, and is designed for professionals and small businesses. The facilities management system furnishes computer-based project control, so the manager may be freed to manage. PHILIP HANKINS INC., Arlington, Mass. For copy:

CIRCLE 264 ON READER CARD

**PAPER TAPE READERS:** Complete line of readers for opaque, translucent and transparent tapes is described in six-page brochure. Reading techniques cover through-the-tape, photoelectric punched tape, and reflected light applications. Read speeds go up to 1,000 characters per second synchronously and 240 characters per second asynchronously. Information on tape handlers is also included. GENERAL ELECTRIC CO., Oklahoma City, Okla. For copy:

CIRCLE 265 ON READER CARD

**OMNITESTER:** Snazzy, outsize, four-color 12-page brochure describes self-programming automatic test system for checking and maintaining electronic equipment. Tests include diode, voltage and current measurements, point-to-point continuity and insulation resistance, impedance and AC/DC dielectric strength. The system furnishes English language printout of fault and instructions for repair. It automatically searches and locates wiring errors. All come with a verification test kit. TELESCIENCES, INC., Moorestown, N.J. For copy:

CIRCLE 266 ON READER CARD

**FILM FINDER:** Microfilm information retrieval system is described in applications bulletin. Called "Micro-Triev," it features cross-referencing that furnishes data location without referring to original source. References are both alphabetic and numeric. Setup service includes master file, input documents, procedures and training. Updating is done as needed. COMPUTER INDEX CO., Needham Heights, Mass. For copy:

CIRCLE 267 ON READER CARD

**APL:** The characteristics of APL, IBM's programming language, are given in four-page brochure with extra sheet of bibliography. Brief notes tell the basic commands used in the system, representation of variables and numbers, workspace capabilities, and operational features. The distinction between execution and definition modes is explained, as well as that between common and individual program libraries. A full page is also devoted to the APL terminal system. COMPUTER INNOVATIONS, Chicago, Ill. For copy:

CIRCLE 268 ON READER CARD

**The only thing  
Raytheon Computer does  
is your job.**

**Precisely.**



**RAYTHEON**

CIRCLE 40 ON READER CARD



## Ultramation: a computer that rushes in where others fear to tread.

On ships plowing through icy water. In vans bouncing along jungle roads. In aircraft soaring five miles high. On production lines working next to heavy, vibrating machinery — places you wouldn't dare send an ordinary computer, you can send the ruggedized Honeywell DDP-516.

That's Ultramation: the ultimate in computer reliability from Honeywell.

Inside it's a powerful, flexible, general-purpose computer—our DDP-516. But ruggedized. We protected every logic module against vibration and shock. Tied the tilt-out drawers at four integral

points —making it virtually non-resonant (below 500 Hz). Gave it EMI suppression by enclosing the system in a welded steel cabinet and shielding the input/output, air intake/exhaust, and control panel.

Result: certification from Avco's independent testing laboratory that the computer meets applicable military and shipboard specifications — the first such certification ever given to a standard production computer.

Get all the facts on the fearless 516. Write Honeywell, Computer Control Division, Framingham, Massachusetts 01701.

The Other Computer Company:

**Honeywell**

CIRCLE 57 ON READER CARD

## look ahead

classroom homework to development of IR systems. To assure all reticent users tired of reprogramming, MIT has guaranteed the Multics service life for at least three years. The system handles a maximum of 30 simultaneous users; a second 645, now doing testing and backup jobs, will be put into regular service by year-end. It'll increase the number of simultaneous users to 50. The project is using its "third crack" at PL/I, said by one expert to be the U.S.'s best.

### BIT NOT IN PIECES

Rumors of financial trouble and wholesale firings by minicomputer maker BIT, Inc., Natick, Mass., are denied by Pres. Ted Sapino, who says the firm secured \$1.6 million privately after deciding not to go public in last year's bear market. BIT's now undergoing a "periodic consolidation" which has involved "some reductions" in production personnel. But it has increased use of subcontractors to step up production and take advantage of low rates from defense contractors suffering from recent federal cutbacks.

### CMC JOINS CROWD: OFFICES CLOSE, \$ SHORT

Computer Methods Corp.'s western division was obliterated last month, despite sales of \$400K for '69, most of it in software packages. One NYC office, developing a brokerage system, is also rumored closing. Pressure for these moves comes from parent Coburn Corp. of America, which is suffering from a 2-megabuck loss in '69, may be bought by Colonial Commercial, and (or?) is said to be thinking of selling CMC.

Coburn reportedly couldn't provide the cash to continue software development, which at CMC-west involved a series of packages making up a file management system for small users. The 18-man western staff, down to two by Jan. end, had sold 80 of its \$11K Testpac packages.

### UNBUNDLING SPAWNS NEW FIRMS, SERVICES

"System architect" is the latest greatest buzz word, a product of unbundling. Many firms and organizations are gearing up to offer, often under monthly retainer, hardware/software "shopping" and evaluation services to help the user obtain the cheapest, best system. Among them are Pansophic Systems (Chicago), Touche Ross, and groups in medical dp services. And there's a new firm in Boston called System Architects Inc.

System engineering services under a monthly time & materials retainer are also being offered. Complex Systems Inc., New York-based telecommunications specialist, has picked up four such contracts, is asking \$120-\$255 per 7- or 8-hour day depending on job complexity and SE experience.

### PLUG-IN UNIT SHOWS UNUSED CPU CAPACITY

A cheapie readout device that tells what per cent of a cpu's capacity is not being used at any given time has been developed to sell for \$250. Designed to replace the wait light on the console of a 360/30-or-up, the plug-in meter might indicate relative efficiency of a program and whether it's the core or processor that's overloaded. According to inventor, James P. Foust of LA, an add-on unit will drive a plotter to provide a written record.

### YA GOTTA KNOW THE TERRITORY

A new educational software package is being offered under license to t-s outfits using BASIC by Tecnica Education Corp., San Carlos, Calif., (Oct. '69, p. 49). The license for the package grants the buyer

(Continued on page 235)





## Free. More than a decade of keyboard technology with every keyboard you buy.

MICRO SWITCH all solid state keyboards are a solid investment. Immediately, you net a return of more than a decade of experience and leadership in the rapidly changing field of keyboard technology.

1957-1964—Developed and manufactured highly reliable mechanical keyboard switches.

1964—Introduced the KB modular switch. Mechanical switching and encoding in a single switch.

1965—Introduced the first reed switch keyboard.

1967—Introduced the first reed switch keyboard featuring integrated circuit encoding.

1968—Introduced the all solid state keyboard. Pioneered the use of an integrated circuit as a switching element.

1969—Introduced the first solid state MOS encoded keyboard.

MOS adds a new degree of flexibility in providing up to four codes per key. In addition, discrete components are reduced by a factor of nearly one hundred. This increases reliability and lowers maintenance costs.

Dollars just can't buy the experience we've gained in these 12 years. But you can buy the product of this experience. Our MOS encoded keyboard.

Let's get together and discuss keyboard technology or any other part of the business you consider important. Dollars. Compatibility. Reliability. Delivery. They're all important to us. Call or write us and see.

## **MICRO SWITCH**

FREEPORT, ILLINOIS 61032

A DIVISION OF HONEYWELL

CIRCLE 65 ON READER CARD

## look ahead

a defined geographical territory; a program library covering math, business ed, and the social and physical sciences; teachers' resource materials; student work sets to be used on the terminals; and computer-trained, certified teachers to train the service center's personnel and help with initial sales calls. The price of the license is around \$25K, with \$1K down and the balance to be paid out of revenues from the system, payments not to exceed \$500 a month.

### INCOME TAX INPUT AND OUTGO GETS BANK TRYOUT

Income-tax-form-leery citizens in the Monterey and San Diego areas of California will have a chance to try on-line tax return preparation this spring at 15 United California Bank branches where trial tty terminals have been installed. The terminals are tied into a B5500 at Century Information Sciences, Inc., in LA, which, along with Taxtronics, Inc., NYC, is providing the system.

An operator at each terminal will enter tax info into the terminal, the computer computes, and tax forms 1040 and 540 (Calif. form) are completed on the same teleprinter within, the firm claims, seven minutes from the time of initial interview. Price is \$15 for a 1040 (the short form 1040A is no longer) and \$25 for both federal and state. And the loan dept. is just down the counter.

### FOUR STAKE FUTURE ON 96-COLUMN CARD

A ringing vote of confidence in the future of System/3 has been cast by four long term Univac-ers (Warren Shultz, Frank McPherson, Tom Richardson, and Howard Bernard). They've formed Decision Data Corp., Warminster, Pa., to make and market 96-column card peripherals (punches, sorters, readers, data preparation equipment, and "more advanced peripherals"). When ordering a System/3 for themselves recently, they were informed: ". . . It takes two months to process the order, another 15 months for card, or 21 months for disc."

### COM RISES IN THE EAST

Word of a new company in computer output microfilming leaked out at the National Microfilm Assoc. meet in San Diego. Not ready to announce its product yet, the company is called Compufoto, is located in Mass., and has Patrick V. Marasco as its president. The COM device the company plans to introduce is thought to be another breakthrough in the price/performance lists.

### RUMORS AND RAW RANDOM DATA

With IBM's test version of ANSICOBOL out, many users face conversion again. One estimate is in from Ford, which planned ahead by hiring Information Management Inc. to develop compilers as close as possible to the then-developing standard. Result: conversion of most of the 15-20K COBOL programs will cost about \$2 million vs. \$4-5 million if they'd used available pre-ANSI compilers . . . ADR has announced it's the first software firm to unbundle. The company will sell its "hardware"—a hexamatic slide rule that adds and subtracts in hex, and converts hex to decimal and vice versa. Free before, the unit is \$3, has quantity discounts . . . Computer Machinery Corp. continues to run far ahead of the pack in its brand of computer-based data entry systems—with 20 in, 200 to go in this year, and expected gross of \$30-35 million. Logic Corp. has three systems in and three on order; one sale at the Univ. of Penn. was part of the stipulation of a will, we hear. Penta and Realtronics: a few orders, no installations. Honeywell salesmen keep hinting they'll have an entry in this market, no word yet.

# The proud printers...



**\$6134.**  
F-80

**\$7136.**  
F-132

**\$7465.**  
V-132

Optional  
sound deadening  
enclosure.

## with the modest prices.

These OEM prices (fifty units) include: 600LPM printer mechanism; pedestal mounted electronics, with a single-line memory; and 8 channel Vertical Format Unit on F-132 and V-132. Sound deadening enclosures are also available. You can, of course, purchase mechanisms only.

A proud addition to the Data Printer family is the new Model

V-132, which incorporates the same dependable operational and design characteristics as our popular F-80 and F-132 models, but with one important difference: the V-132 will accommodate form widths from 3½ to 19½ inches.

We're as proud to build Data Printers as you will be to own one. So, why not call or write us for additional information?

## Data Printer Corp

225 Msgr. O'Brien Highway / Cambridge, Ma. 02141 / (617) 492-7484

# world report

---

## CERN AND WEATHERMEN OPT FOR BIG MACHINES

Europe opened the first month of the seventies with two developments in the big machine arena. First, the French government-backed Compagnie Internationale pour l'Informatique picked up its first big export order with a contract for its biggest system, CII 10 070, due to surface in two years' time. It came from the European Centre for Nuclear Research, at Meyrin just outside Geneva, and is part of a rather fascinating story. The second event was the placement of an order by the British Meteorological Office for an IBM 360/195.

IBM's monster will be used for developing long-range forecasting methods for periods of a week and more ahead, and it will also be the key part of the UK contribution to the World Weather Watch system, which by the mid-seventies will have a network of interlinked machines in America, Asia, Europe and Australia monitoring the global changes in the environment. The British weathermen have been debating an installation for about two years, but have been handicapped by pressure to wait for a suitable big system to emerge from International Computers Limited (ICL). The Met Office has hankered after a CDC 6600 and then 7600, but had been unable to get government approval for buying from overseas. Three months ago ICL shelved its year-old paper monster, the 1908A, which has been replaced by a mysterious Project 52. But with a bottleneck already building up on the weathermen's KDF9, prospects for further delays pushed the order into IBM's timely-announced 195. The machine on order has a one megabyte store, two 4-million-byte drums, two 500-million-byte disc units, plus a battery of other peripherals for automatic preparation of forecast charts. As data streams into the meteorological centre from land and weather ship observation stations plus satellites and data links from other countries, the 360/195 will sit in the middle of a vast computer controlled communications net.

The order for a CII 10 070 by the Centre for Nuclear Research, CERN, comes from another customer that has been strongly wooed by IBM. And the new 256K machine will go to join a CDC 6600, 6500, and 3100, plus 24 other systems used by the high energy physicists to analyze the three to four million films made each year of bubble and spark chamber events. However, the contract has been placed as rumbles emanate from CERN indicating an interest in becoming a European computing laboratory as well as a centre of excellence in nuclear physics. At the moment, the lab is considering adding a 300 GeV accelerator (costing about \$400 million) for investigating the weird happenings at a sub-atomic level that fascinate nuclear physicists so much.

CERN is a multinational laboratory founded by a number of countries, predominantly Britain, France and Germany. Last year the British Government refused to support the plan for the 300 GeV and France was certainly very lukewarm about the idea. Surprisingly, the French government decided a month ago to give its blessing and, surprise, for the second time the French government-backed CII found



## New Dimensions in Computer Graphics

Dresser's Lasergraphic Plotter is as fast as your computer.

**New speed.** Dresser's LGP-2000 will plot as fast as your computer can feed it data, and speed is completely independent of plot density. **New size.** The LGP-2000 will plot up to 40 inches wide by 100 feet long. **New gray scale.** Up to 16 shades of gray for continuous tone, photographic plotting.

The LGP-2000 will draw you a 6-foot printed circuit board in 2 minutes and 3 seconds flat. Or, a 24-inch by 36-inch contour map

with 2,000 inches of line and 3,000 characters of annotation in only 54 seconds!

The new Dresser LGP-2000 can even draw a 40-inch by 40-inch photo of the Earth composed of 1,600,000 points in 16 shades of gray in only 1 minute and 38 seconds.

Thanks to Dresser, plotters have finally caught up with computer speeds. Don't be left behind.

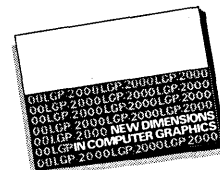

Write for a detailed brochure on the Dresser LGP-2000.

**DRESSER**

**Dresser Systems, Inc.**  
ONE OF THE DRESSER INDUSTRIES  
10201 Westheimer, P.O. Box 2928  
Houston, Texas 77001 (713) 781-5900

The average reading time for this ad is 25 seconds. In this time, the Dresser Systems' LGP-2000 could have plotted 25,333,075 bits of information.

it had a customer for its biggest machine, the CII 10 070.

And with the terms barely dry on paper comes a rumbling that there were those in CERN who felt its vast computer facilities should be turned to better advantage. CERN's computer operations manager, M. Charles Symons, has been reported as exploring possibilities for exploiting the lab's experience in large file processing, time-sharing and multiprocessor systems. Feelers have already been put out among big users such as Rolls Royce and manufacturers such as Philips for reactions.

Curiously, these ideas coincide with Rolls Royce's own steps to turn over some of its computer facilities to service work, as reported last month. By the mid-seventies the cost of running CERN will be about \$150 million a year compared with about \$35 million in the mid-sixties. Apart from satisfying the curiosity of nuclear physicists in very expensive fundamental research, nothing of much practical benefit emerges for this expenditure. So the idea of exploiting some of the vast resources of the lab could have attractions for the member nations.

### USERS COMPLAIN AND A BULLETIN LOOKS AT WHY

Complaints about the data transmission services available from Europe's PTT's are frequent, many and varied. They range from dissatisfaction at mechanical faults that make transmission virtually a waste of effort (Italy), superb but limited connections (Germany), just great if you are an influential big customer (Britain), fair if you are patient (France), to thorough if you understand the administrative organisation (Holland).

Much of the difficulty lies in the fact that many communications authorities are upgrading services to all-electronic and computerised exchanges, and troubles come at the interfaces of old and new equipment, etc. An interesting overview of developments in European telecommunications is contained in Euro-Spectra, a quarterly bulletin of the Commission of European Communities, which includes Belgium, France, Germany, Italy, Holland and Luxembourg. It lists the density of telephone subscribers of the countries and reports on a study of the capital investment programme of these countries, with forecasts of the time to develop a comprehensive digital communication net for the communities. Euro-Spectra, Volume VIII, No. 4; price \$1, from Agence et Messageries de la Presse, 1 Rue de la Petite Ile, Brussels 7, Belgium.

### BITS AND PIECES

Scandinavian Airlines has officially opened Sasco II, the upgraded passenger, baggage, cargo, mail and fuel control system for the company's European operation. The manufacturer, Univac, claims it is the largest real-time installation in Europe and has certainly shoved in a lot of hardware — three Univac 494's, three 418's, 500 remote terminals, plus all the bells and whistles. With five other 1108 installations in the area, it probably means Univac is more profitable in Scandinavia than anywhere else this side of the pond . . . After a year's operation with a prototype digital tandem telephone exchange in London, the UK Post Office has decided that plans can go ahead with developments of PCM switching of speech channels . . . Computer Analysts and Programmers has delivered an ASA basic Fortran compiler to Marconi-Elliott Computer Systems for the 902 system — a 12-bit machine for military, industry and scientific applications.



# NOW...

## Low cost plug-for-plug replacement of System/360 original tape units from TI!

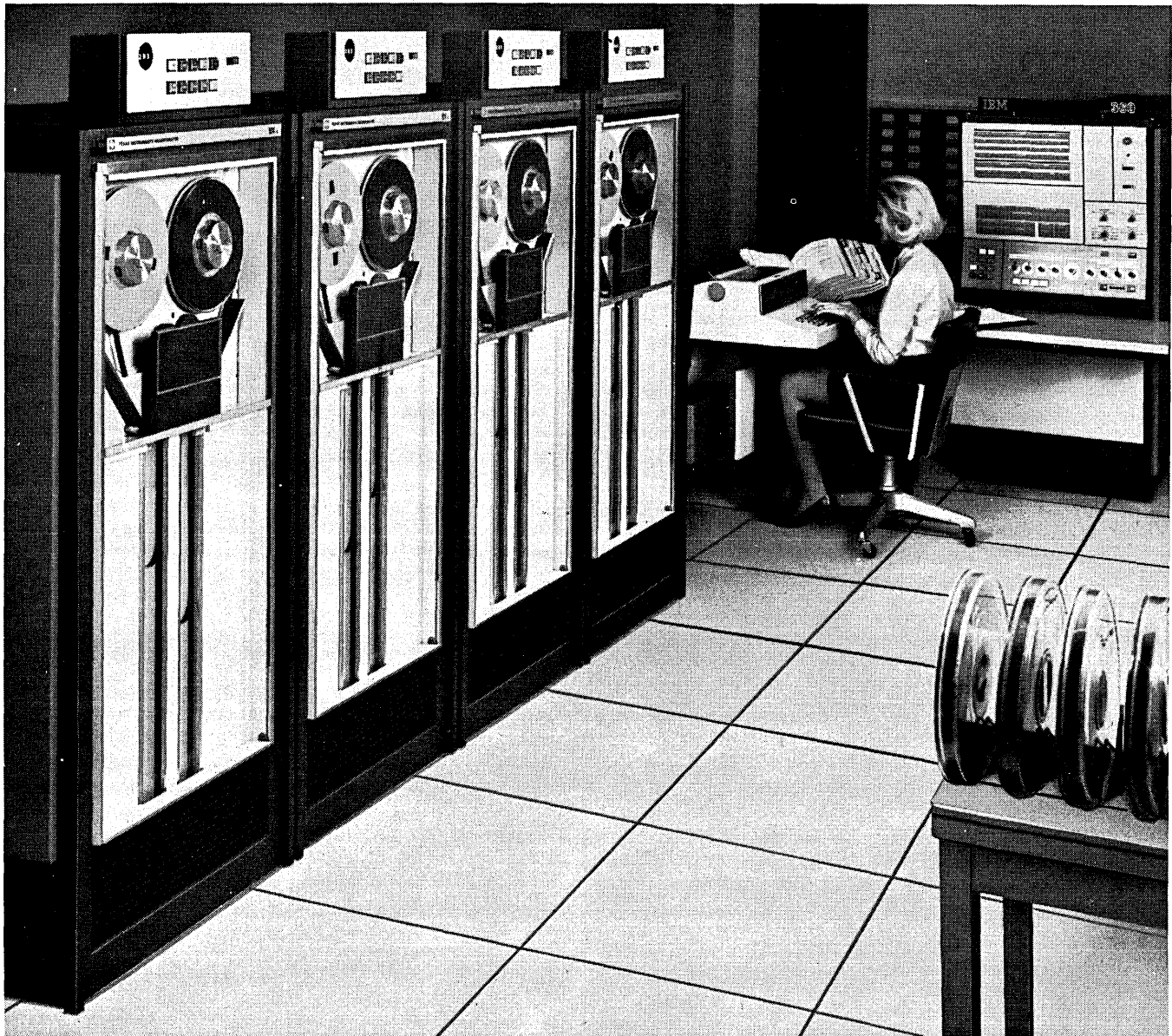

Unplug the original tape units, plug in the Series 924 Magnetic Tape units. Your System/360 gets better performance at lower cost. Whether you lease or purchase, the new Series 924 units offer a lower price than original equipment (as much as 50%), and better performance in tape and data handling.

Your tapes will last longer, data transfer will be more reliable and routine maintenance requirements

will be lower. If you are considering updating or enlarging your System/360, or if you simply want to reduce costs and tape-unit downtime, get the facts from Texas Instruments!

Write or call Industrial Products division, Texas Instruments Incorporated, P.O. Box 66027, Houston, Texas 77006 (713-526-1411). Ask for data about the Series 924.



See this Product at the TI Booth—1970 IEEE Show

**TEXAS INSTRUMENTS**  
INCORPORATED

265

# washington report

## MICROWAVE TIDE GETS HIGHER AND HIGHER

Licenses to offer microwave common carrier service between St. Louis and Dallas, and Dallas and Houston have been requested from FCC by MCI-St. Louis-Dallas, Inc., and MCI Texas East Microwave, Inc., two newly formed affiliates of Jack Goeken's burgeoning telecommunications empire. Meanwhile, three firms have announced their intention to compete with MCI Pacific Coast, Inc., — Southern Pacific RR, Microwave Service Co., and Sierra Microwave. Goeken's Chicago-St. Louis line, the only one licensed so far, has reportedly signed up so many customers that the system is being expanded to 1800 channels (from 300), raising the installation cost to 2 megabucks.

## TECHNITROL WINS A ROUND IN BOUT WITH U.S.

Technitrol has won a leg up in its patent infringement suit against the U.S. government; Honeywell, CDC, XDS, Collins Radio, and Excello Corp. (Bryant Computer Products) have a big stake in the outcome.

The basic issue is whether a magnetic disc memory system patented by E. Stuart Eichert, president of Technitrol, and T. K. Sharpless, was conceived during development of the Edvac computer at the U. of Pennsylvania between 1944 and '46. The government, which is licensed to use all Edvac-inspired inventions; says "yes." Technitrol, which patented the memory system in 1948, says the system was conceived after Eichert and Sharpless left Penn., and, on their own, invented a unique addressing and memory reset technique. Recently, James F. Davis, a U.S. Court of Claims commissioner, agreed with Technitrol. The Justice Department is scheduled to file exceptions to his opinion this month.

Honeywell, et al, are concerned because Technitrol is also suing them; a favorable final decision in the government case would, on the basis of what lawyers call "comity," tend to produce a likely result in the other suits. The system makers insist they aren't infringing Technitrol's patent, and add that even if they are, the patent is invalid.

## GSA LOOKS THROUGH NEW SPECS

GSA has begun work on a spec for 11-high disc packs (2316-compatible) that will permit volume and centralized procurement. Specs for 6-high disc packs, and for mag tape, were issued earlier. The first centralized buy of 6-high packs is scheduled "before the end of this fiscal year." Meanwhile, NBS is making plans to establish a calibration service for disc manufacturers.

## CAPITOL BRIEFS

Jerry Clay, trump card in CDC's Wimmix bid team, has joined Computer Learning and Systems Corp. as special assistant to software vp Bill Thompson. Clay says he's investigating the "whole area" of computer system performance measurement and analysis with a view toward developing marketable hardware and/or software products . . . Three more proposed federal dp standards recently were scheduled for publication in the Federal Register, a preliminary to their official adoption. The standards — X3.15, 3.16, and 3.25 -- relate to bit sequencing and character structure in various forms of serial and parallel transmission of USASCI-coded data.

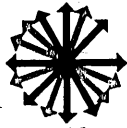

# people

An antidote for the February wearies: **Scott Kelso**, president of Seismic Computing Corp. since 1964, is retiring at the age of 41. But the Texan (Houston) will not be sitting in his patio. He plans to look for new ventures. His former post at the geophysical data firm will go to **James Mitchell**, promoted from exec vp. . . . **Dr. Leslie K. Gulton** resigned as chairman of his own board (Gulton Industries), then became chairman of Vernitron Corp.,



computer-oriented technological company with seven divisions and 17 subsidiaries. **Bernard Levine**, ex-chairman who will continue as president and chief executive officer, welcomed both Dr. Gulton's "wealth of scientific knowledge and business background." . . . **David C. Arnold** has switched presidencies—from Hoffman Electronics Corp. in California to Conduction in Missouri (he comes from Iowa). His place at Hoffman has been taken by **Dr. Wendell B. Sell**, former president of Teledyne. Conduction makes guidance, control and communications systems as a subsidiary of McDonnell Douglas. . . . **Ely Francis**, a finance and administration specialist who helped the Elgin Watch Co. to tick profitably again, has become president of the eight-year-old Community Corp., data terminal equipment manufacturer based in N.Y.C. . . . **William W. Wright**, management consultant and financial expert who has been chairman or director at some Very Important Companies (Electronic Memories & Magnetics, Beckman Instruments) has become a director at Microdata Corp., Santa Ana, Calif., computer manufacturing and consult-

ing firm. . . . Another business consultant, Beckman instrument alumnus, and Annapolis engineering grad, **John C. Wyman**, has stepped into the presidency of Datanetics, L.A. area manufacturer of data entry keyboards and peripheral equipment. Former president **Richard K. Gerlach** is remaining with the company in an executive capacity. . . . Two executives who both have been with their company for 33 years are together at the top, with the election of **K. P. Morse** as board chairman/chief executive officer and **Don F. Whitehead** as president/chief operating officer of the Standard Register Co. in Dayton, O. They are looking forward to implementing the "many plans and programs we have worked on together for the 1970's". . . . New President/chief executive officer of Optical Scanning Corp. is **John N. Veale**, promoted to succeed **John W. Busby**, founder of the Philadelphia company in 1960, who has moved on to board chairmanship. . . . In government, NASA's new Information Sciences branch in its research division will be headed by **Samuel A. Rosenfeld**, Auerbach and Mitre man, out of Harvard via Brooklyn Polytechnic Institute. Besides directing research in artificial intelligence, linguistics and storage and retrieval, his branch will

look into the "human processing of information". . . . Congressman **Emilio Q. Daddario** (D.-Conn.), who as chairman of the House Subcommittee on Science, Research and Development has presided over some of the software patent controversy, will be a featured speaker at the Information Industry Association's second annual meeting in Washington, D.C., March 23-25. . . . And **Dr. Ned Chapin**, noted dp consultant, is directing seminars for the COMPSO software and peripherals shows being held in N.Y.C., Chicago and L.A. Dr. Chapin is with InfoSci, Inc., Menlo Park, Calif., has authored books and many articles, worked with Stanford Research Institute. . . . The IEEE Computer Group, which will hold its big annual meeting in Washington, D.C. in June, has elected **Dr. Edward J. McCluskey** chairman for 1970. He is professor of computer science, and director of the Digital Systems Lab at Stanford Univ. . . . The American National Standards Institute has secured the services of **Charles E. Ginder**, who has taken charge of its information processing engineering section, and will administer standardization efforts. He was previously with BEMA, where he also coordinated standardization programs. He's had 26 years executive experience with business trade associa-

This announcement appears as a matter of record only.

150,000 Shares

Redcor Corporation

Common Stock

Private placement of these securities  
has been arranged by the undersigned.

Loeb, Rhoades & Co.

November 24, 1969

CIRCLE 165 ON READER CARD

tions. . . . The Diebold Group has a new president, former vp at rrr—**Raymond LeKashman**. He originally was president of a management consultant firm founded by him and other former partners in a spin-off from Booz, Allen, Hamilton, for whom he developed operations in Western Europe. He will develop U.S. consulting activities for Diebold, which recently also installed a controller. . . . Reservations World, the computerized reservations system acquired by American Airlines from the Diners Club, has installed an AA man, **James N. Sowers**, as president. He was in charge of diversification for AA, now presumably will be suitably diversified himself, promoting hotel/motel/car rentals. . . . **George E. Dashiell**, president of U.S. Magnetic Tape Co., also has been elected president of Information Network Corp., both subsidiaries of Wabash Magnetics. Now hq'd in Phoenix, Dashiell was formerly a division vp at RCA in its graphic system and edp divisions, plus having experience with Burroughs and IBM. He is a joiner—everything from the Philharmonic Society to a council on crime and delinquency. . . . RCA itself has rearranged positions to go with its new Computer Systems Div. **L. Edwin Donegan Jr.** is vp/gm responsible for overall operation; **Edwin S. McCollister** was appointed marketing vp, and

will also serve the memory products, magnetic products and graphic systems divisions. All are under the Information Systems Group. . . . **Sergio Bernstein**, a native of Milan, Italy, who earned his electronic engineering degrees at CCNY and NYU and went on to be credited with significant contributions in image processing, Doppler navigation, radar and color tv, has been elected president of Data Plus, Inc., White Plains service organization specializing in evaluating and operating computer systems and facilities. . . . **George Wulfing** has been named president of Infotec, Inc., company which designs, manufactures and sells business communications systems and software services from Plainview, N.Y. He was formerly president of Digital Electronics, Inc., a vp of CEIR, and holds three dp-related patents. He succeeds **Paul Seckendorf**, who has retired. . . . At Infoton, Inc., Burlington, Mass., **Joseph G. Wohl** has been appointed vp for information sciences, responsible for systems analysis and software support of that company's crt terminals, optical page readers and data acquisition systems. He holds a NASA award for his work in computer use and display applications, was formerly vp in charge of man-computer programs at Dunlap & Assoc. . . . **Dan L. McGurk** has succeeded to the

presidency of Xerox Data Systems, following **Max Palevsky**, who will now be chairman of the board, as well as remaining chief executive officer of the company. McGurk has also been accorded a group vice presidency in the parent Xerox Corp. Two other promotions at xds: **Harry P. Rosen** to vp, purchasing, and **Jesse Rifkind**, vp and director of peripheral development. . . . **Leo J. Mott** has moved up to the presidency of University Computing Co.'s computer utility network. . . . **Richard I. Grove** has been named president of Dataflo Business Machines Corp., recently formed peripheral manufacturer now working on IBM-compatible controllers. He comes from Data Products Corp., also in L.A. . . . **Peter R. Williams** has been named engineering vp and secretary of Computer Optics, Inc., Bethel, Conn., maker of computer-derived display systems for information retrieval, editing and distribution. He was formerly in new products research at the Norden division of United Aircraft Corp. **Thomas D. Kagelman**, who also came from Norden's new products research department in 1968, has now become coi's board chairman as well as its president and chief executive. . . . New lineup at Logic, Inc., dp consultant in Dallas: **David B. Dibrell** has moved up to president; **Joe A. McHenry** has

## Computer Scheduled MAGNETICALLY

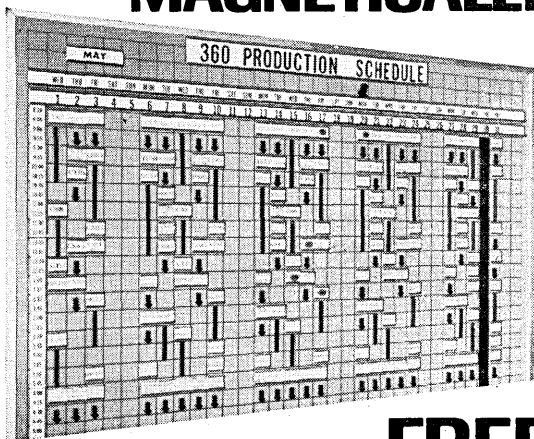

Write for 28 Page Illustrated Catalog **FREE**

- Keep your computer running—not idle.
- Schedule in 6, 10, 15 & 30 min. cycles, for daily, weekly or monthly periods.
- Know in advance when slack periods or heavy work loads are coming.
- Make changes & additions immediately.
- Every hour saved saves you \$20-\$40-\$60.

Representation throughout most of the United States  
TELEPHONE 212-442-4900

# METHODS RESEARCH

70 WILLOW AVE., STATEN ISLAND, N.Y. 10305  
CIRCLE 175 ON READER CARD

February 1970

## A GUIDE FOR SOFTWARE DOCUMENTATION

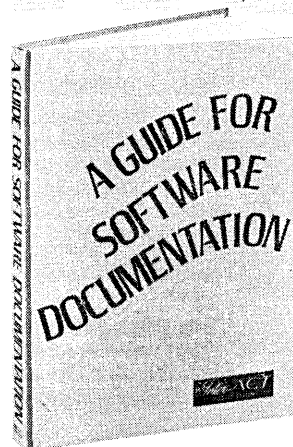

Compiled and edited by  
**Dorothy Walsh**  
Vice President  
Advanced Computer  
Techniques Corp.

The only reference available for the development and evaluation of programming documentation. This guide contains 14 flexible models spanning all documentation needs from designing a product specification to writing a generalized software manual.

Send me a copy of A GUIDE FOR SOFTWARE DOCUMENTATION. Enclosed is \$16.25.

Name	Title
Company	
Address	City, State, Zip

### INTER-ACT CORPORATION

Education and Publications Subsidiary  
of Advanced Computer Techniques Corporation  
437 Madison Avenue • New York 10022 • 212-421-4688

CIRCLE 196 ON READER CARD

## people . . .

left his former position as dp-vp of Empire Life to head Logic's newly-formed data center division, which will computer-service life insurance companies, and **Doyt L. Cassel**, who develops and directs fire and casualty systems, has also been elected vp. . . . Computing Efficiency, Inc., software and facilities management firm in Deer Park, N.Y., has appointed **John J. McElroy** executive vp and treasurer. He is a triple-threat man, a Harvard business school graduate as well as having an engineering degree from MIT, where he was also managing editor of the undergraduate newspaper. It was all done on scholarships. Between education and army leaves he was employed and partly sponsored by Grumman Aircraft, where he was latterly director of manufacturing planning and control. . . . On the international scene, **William S. McCalmont** is new manager of European operations for Memorex, hq'd in Maidenhead, England. He replaces **John R. Eastling**, who is returning to a Stateside Memorex post. . . . **James R. Fullam**, veteran Univac marketer, is deputy managing director of their English subsidiary, will supervise U.K. operations from

London, moving there from Pennsylvania with wife and five sons. . . . Manufacture of electronic products in Singapore for Litton Industries Components Group will be the responsibility of **Robert G. Rose**, who has been with that company since 1947. **Donald F. Payne** will direct international planning for Litton's Defense and

Space Systems Group, whose products include inertial navigation, digital dp and communications systems. . . . **Leonard Pernick** will direct time-sharing operations for Leasco World Trade Co. Ltd., which will be started in London, Stockholm and Rotterdam. He was formerly systems analysis manager with North American Rockwell. ■

## HAPPINESS IS A PROGRAM THAT RUNS

What is that feeling of blissful  
euphoria  
Programmers know and feel  
When their program at last is running,  
Is finished, is actual, is real.

Ah, the transports of triumph that  
come  
Are like fragrance of incense and  
honey;  
Like radiance after the rain:  
The testing will cost no more money.

The rapturous glow of elation  
Steals over the spirit like mist  
When at last the new brainchild is  
formed

In material cards and a list.

Who remembers in final attainment  
The torturous twistings of mind  
When chaotic, elusive, the logic  
Had lapses, omissions to find.  
Who recalls the grim suffering lone  
That the programmer had to endure  
When the polished, perfected new  
program  
Stands finished, inviolate, pure.

Oh, none may describe in a poem  
His joys of battles won,  
His expansive delight with the world  
When his program has perfectly run.  
—RAE ORY

# PL/1 BASIC COBOL

## Addison-Wesley speaks your language

### PL/1 FOR PROGRAMMERS

by Ramon C. Scott and Norman E. Sondak,  
*Worcester Polytechnic Institute*

This text was written to allow the reader, already familiar with computer programming, to learn PL/1 from examples chosen to illustrate language concepts in the sciences, business and the humanities. A unique feature of the text is an integrated approach of discussion, examples and complete programs. **392 pp, \$6.50 (1969)**

### A GUIDE TO *Basic* PROGRAMMING: A TIME-SHARING LANGUAGE

by Donald D. Spencer, President, *Abacus Computer Corporation*

Intended for the many people who would like to know what computer programming is about, this text uses the BASIC language as its teaching vehicle. It is possible to use this book in conjunction with any time-sharing computer system that has implemented the BASIC language. **216 pp, 67 illus., \$5.95 (1970)**

### BASIC COBOL PROGRAMMING: SELF-INSTRUCTIONAL MANUAL AND TEXT

by Laurel M. Spitzbarth, *Illinois Institute of Technology*

The purpose of this text is to introduce the student to the fundamental techniques of computer programming through the language of COBOL. It is designed to be self-instructional. The student can learn on his own, and test himself, with the help of self-tests included at the end of key chapters. **335 pp, 229 problems \$5.95 (1970)**

Addison-Wesley  
PUBLISHING COMPANY, INC.  
Reading, Massachusetts 01867



THE SIGN OF  
EXCELLENCE

CIRCLE 11 ON READER CARD



# recruitment advertisers' index

For the convenience of those readers interested in professional opportunities, we have gathered in this and the following pages the advertisements of these industry firms and professional placement agencies:

Albert Associates .....	261
Albert, Nellissen, Inc. ....	255
American Reserve Corporation .....	263
Cadillac Associates, Inc. ....	257
Callahan Center for Computer Professionals .....	258
The Chase Manhattan Bank .....	251
Data Dimensions, Inc. ....	268
Digital Equipment Corporation .....	264
Drew Personnel Placement Center .....	261
Fox-Morris Associates .....	265
General Motors Research Laboratories .....	253
Robert Half Personnel Agencies .....	262
Honeywell .....	265
IBM .....	260
Information Technology, Inc. ....	267
Everett Kelley Associates .....	267
Lockheed-California Company, A Division of Lockheed Aircraft Corporation .....	270
Lockheed Missiles & Space Company, A Group Division of Lockheed Aircraft Corporation .....	252
The National Cash Register Company .....	269
Parker-Finch Associates, Inc. ....	245
PerSyst Inc. ....	269
Pratt & Whitney Aircraft, Division of United Aircraft Corporation .....	256
RCA Computer Systems Division .....	272
RCA Information Systems Division .....	254
Resources Objectives, Inc. ....	262, 271
RSVP Services .....	271
Sheridan Associates Inc. ....	252
Sikorsky Aircraft, Division of United Aircraft Corporation .....	266
Singer, Friden Division .....	246
Source EDP .....	259
Systemation Consultants, Inc. ....	258

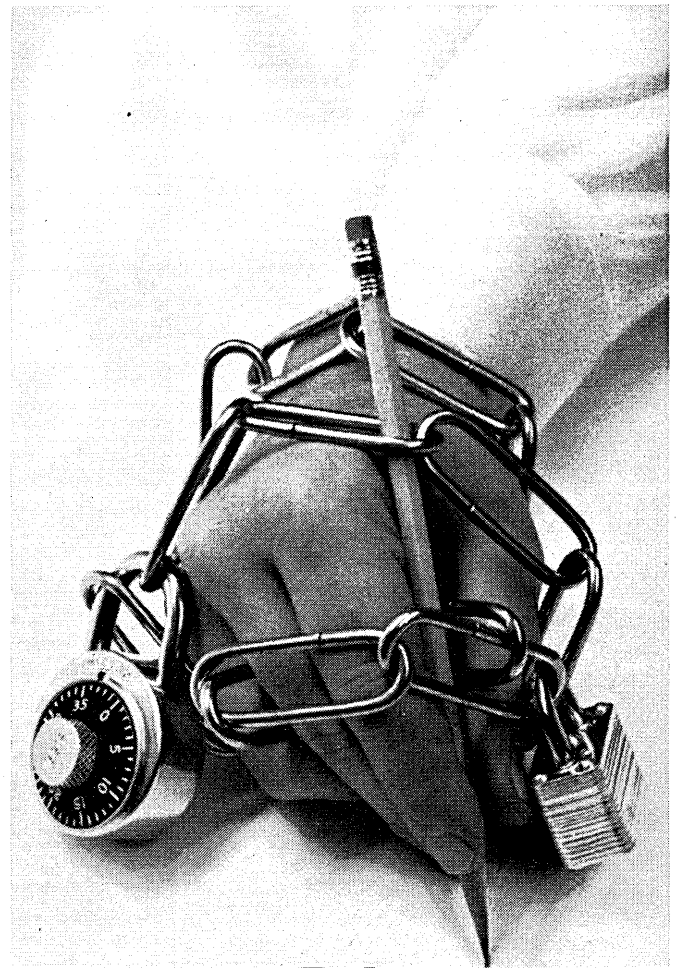

## LOCKED IN— TO DULL PROGRAMMING?

Exciting jobs and better pay in Programming are all around you these days. PARKER-FINCH can help you find the work you want to do—spring you loose from monotonous routine and dead-end work. To have us open new doors to your future, simply send us your resume or call us today. Key jobs are waiting!



Associates, Inc.

576 FIFTH AVENUE  
NEW YORK, N.Y. 10036 • (212) 765-6280





## a National Landmark that goes nine miles an hour

You're looking down Hyde Street toward the turn-of-the-century exhibition ships moored at the foot of San Francisco's Russian Hill.

San Francisco is the only city in the world with an operating cable car system. And so beloved is it, by both natives and visitors, that in 1964 the U.S. Interior Department's National Park Service declared the cable cars a National Historic Landmark.

Little has dimmed the popularity of the city's cable cars. Every now and then someone makes suggestions regarding more efficient modes of transportation, but the resulting public clamor can be heard around the world.

There's sufficient camaraderie that centers around the cable car to last a lifetime. It's just one of the fringe benefits of Friden's career package for the computer professional.

Let's get together and discuss our mutual interests. Forward your resume to Joe Schuler, Systems Design & Development, 2350 Washington Avenue, San Leandro, California 94577. Friden is an equal opportunity employer.

**SINGER**  
FRIDEN DIVISION

SYSTEMS FOR THE NEW GENERATION: Communication Analysts-Business computer communications and software; Applications Analysts-Computer systems analysis; Systems Programmers-Assembler and compiler development; Systems Writers-Software manual development

CIRCLE 512 ON READER CARD

# Shouldn't you be at the Computer Bank?

That's Chase Manhattan, one of the most exciting software houses in the world.  
And we need great people. How about you?

1. Systems analysts
2. Systems programmers
3. Systems planners
4. Multi-programming operations specialists
5. Data communication analysts
6. Senior computer operators
7. Project leaders
8. Automation training specialists

Call either Bill Oglesby or Ron Flint collect.  
Bill's at (212) 552-4676, Ron at (212) 676-3439.  
They'll tell you about the professional career opportunities and excellent fringe benefits waiting for you at Chase Manhattan.

Ask them also about our formal professional development courses—part of Chase's way of helping you keep up to date all the time.

Or send your resume to Ron at the address below.

**THE  
CHASE  
MANHATTAN  
BANK, N.A.**



1 Chase Manhattan Plaza  
New York, New York 10015  
An Equal Opportunity Employer

**The Computer Bank**

Member FDIC

February 1970

CIRCLE 533 ON READER CARD

251

**This U.S. business  
loses over  
\$1,000,000,000  
and 20% of its  
employees  
every year—and  
you pay the losses.**

It's the Post Office. Your taxes must be about \$1.2 billion greater to make up its annual deficits. And your postal service suffers because of the high employee turnover.

Fire the management? You can't do that with the Post Office. Its basic management decisions are made by 535 members of Congress. They control its spending for facilities, its employment costs and conditions, and the rates it can charge for services.

That was fine in 1789 when it all started, but it's time for a change—a complete change. There's a bill, HR 11750, now before Congress which provides true Postal Reform. It creates a government authority (something like TVA) to run the Post Office on a businesslike basis. President Nixon and Postmaster General Blount are behind it. So are ex-President Johnson and his Postmaster General, Lawrence O'Brien. You should be, too, unless you don't mind paying the deficits. Or wouldn't be bothered by a total breakdown of service in your city (like Chicago in 1966).

You can do something. Write or wire your congressman; ask him to support HR 11750, the only bill that will bring true Postal Reform. Do it today.

**Citizens  
Committee  
for  
Postal Reform**

1725 Eye Street, N.W., Washington, D.C. 20006  
Lawrence F. O'Brien/Thruston B. Morton  
National Co Chairmen

**PROGRAMMERS      ENGINEERS**

Washington, D.C. • New York • New Jersey • New England • Philadelphia • Chicago • Minnesota • Texas • Ohio • Florida • Arizona • California • Southeast Asia

If you have a B.S., M.S. or Ph.D. and you are experienced or interested in any of the following, contact us immediately for free career counseling and an objective analysis of your position in today's market.

**PROGRAMMERS**

- Management Info Systems
- Information Retrieval
- Command & Control
- Aerospace Applications
- Real Time/On Line
- Systems Simulation
- Software Development
- Communications

**SYSTEMS ENGINEERS**

- Reliability Analysis
- Digital Computer Systems
- Digital Logic Design
- Digital Circuit Design
- Digital Communications
- Systems Integration
- Soft Ware Analysis
- Oceanography

Salaries range from \$8,200 to \$25,000.  
Our client companies assume all fees.

Forward resume in confidence, or call (collect):

Mr. Martin E. Sheridan  
Area Code 703) 524-7660

**SHERIDAN ASSOCIATES INC.**  
1901 North Fort Myer Drive  
Suite 614  
Arlington, Virginia 22209

(Just over the Potomac from Washington, D.C.)  
Personnel Consultants to the Computer Industry

CIRCLE 516 ON READER CARD

**SYSTEMS  
ANALYSTS/PROGRAMMERS**

**For Medical Information Systems**

The Medical Information Systems Division of Lockheed has immediate requirements for experienced programming analysts. Work is in the area of real-time programming for hospital medical information and business office systems.

Degree and minimum of three years' programming experience required. One year experience with hospital processes highly desirable.

For more information regarding this advanced information systems organization write Mr. H. W. Bissell, P.O. Box 504, Sunnyvale, California 94088. Lockheed is an equal opportunity employer.

**LOCKHEED**  
**MISSILES & SPACE COMPANY**  
A GROUP DIVISION OF LOCKHEED AIRCRAFT CORPORATION

CIRCLE 507 ON READER CARD

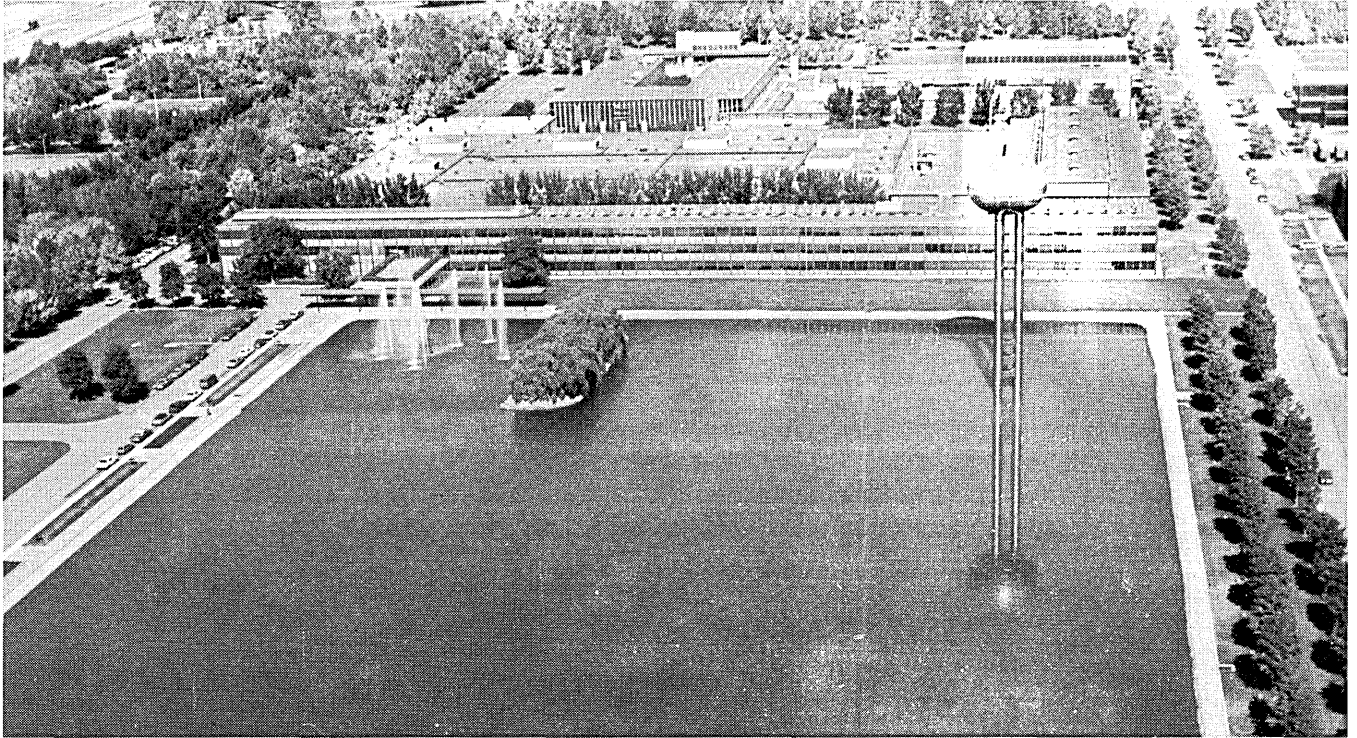

General Motors Research Laboratories make up part of the world-famous GM Technical Center, a 330-acre campus 13 miles north of Detroit and within easy driving distance of Michigan's leading universities and Michigan and Canadian recreational areas.

# Systems programmers!

## At General Motors, the future is your assignment

The planning of tomorrow's larger and more complex information systems has created challenging opportunities for systems programmers at the General Motors Research Laboratories. These professionally satisfying positions involve non-routine, in-depth work in the areas of software development and extensions to large scale computing systems. Research areas include:

- **OS/360 MVT.**
- **Terminal oriented sub-systems.**

- **GE 400 conversational systems.**
- **Virtual memory time-sharing systems.**
- **Computer networks.**

Here, with the central research staff of General Motors, you will be working at the outer edges of computer science with a small select group of colleagues. The contributions of the Laboratories' Computer Technology Department include the development of the computer world's first monitor system (announced in

1956), its first operational computer graphics design system (DAC-I, announced in 1963), and three of its most advanced programming languages (DYANA, 1958, NOMAD, 1962, and APL, 1966). Extensive supporting facilities for your research include major computer systems such as the 360 models 65 and 67.

If you have a degree in math or the sciences, plus the interest or experience to qualify for one of our excellent positions, please contact:

Mr. J. B. Sparhawk / Personnel Staff Engineer

**GENERAL MOTORS RESEARCH LABORATORIES**

Warren, Michigan 48090 / An Equal Opportunity Employer



**We have the biggest growth in time sharing, multi-function, multi-user systems.**  
**We have an eighteen-month lead on the field.**  
**We have some of the best minds in the business.**  
**We have a place for you.**

Are you ready for a change?  
The chance is here right now.  
There's no doubt about the growth.  
It's faster in large, time-sharing, multi-function, multi-user systems

than in any other portion of the computer market. And at RCA we're 18 months ahead of the field already. We call our work "total systems architecture." It offers unlimited opportunities for EDP professionals who do total system designs for hardware and software . . . including software design automation. There's an undercurrent of excitement here as we set our sights on even faster growth in broad-based systems for large time sharing machines. If this sounds like the right place,

we'd like to hear from you. Your experience should be in any of the following: programming; language processing; control systems; operating systems; utility systems; communications systems; micro-programming; field sales and system support; education or product planning.

*Write to: Mr. Thomas Beckett, Dept. 19,  
RCA Information Systems Division,  
Bldg. 202-1, Cherry Hill, New Jersey 08101.  
We are an equal opportunity employer.*

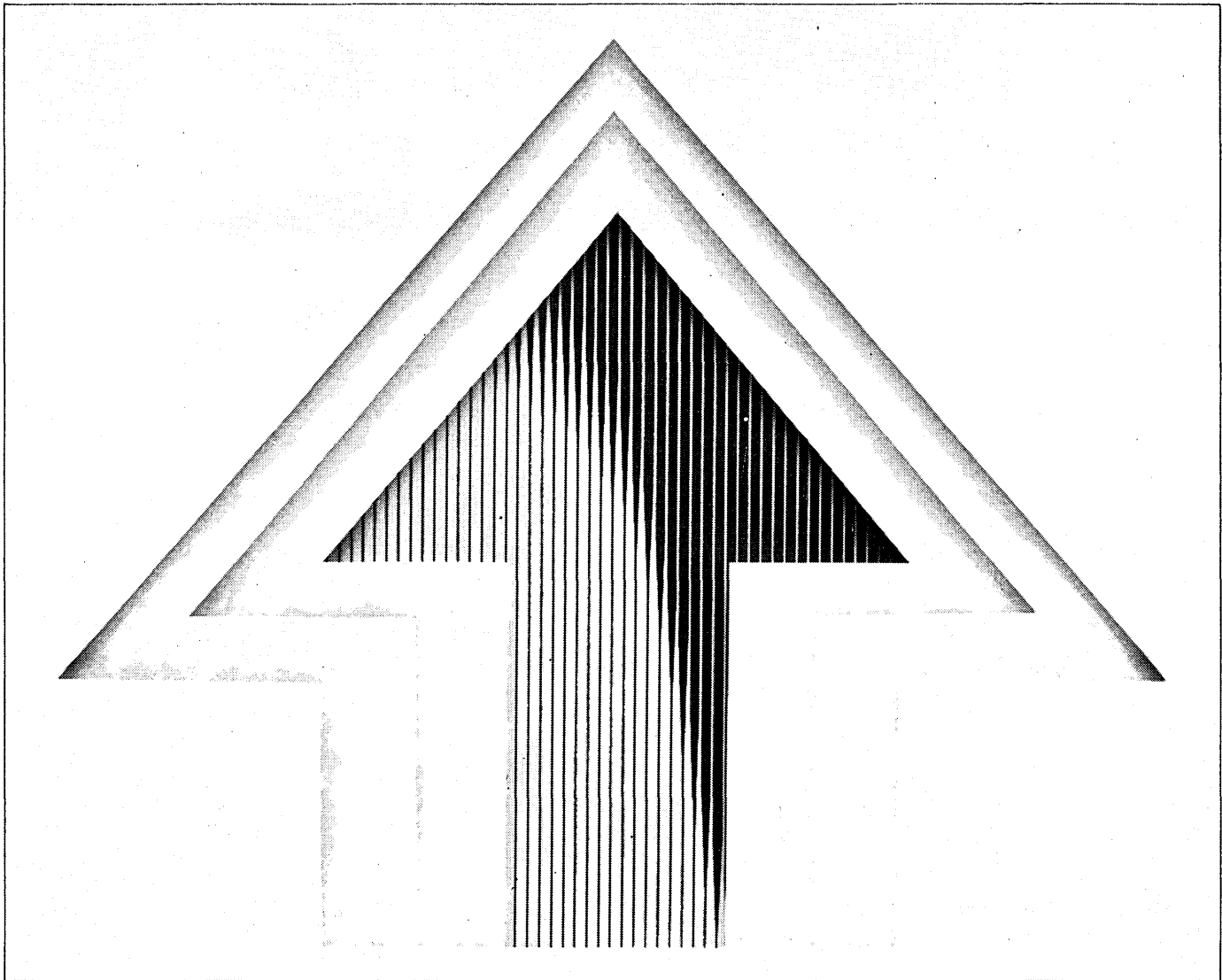

**RCA**  
COMPUTERS



# books

**Computer Graphics: Techniques and Applications**, edited by R. D. Parslow, R. W. Prowse, and R. E. Green. Plenum Press, London and New York. 1969. 247 pages, \$16.00.

This book is a compendium of papers presented at the Brunel University International Computer Graphics Symposium in July, 1968, and as such represents the status of computer graphics at that time. The book is divided into four parts, the first and longest being an overview of computer graphics. There is an introductory paper and summaries of hardware, software, system tradeoffs, and activities in the United States and the United Kingdom. Emphasis throughout the book is on interactive crt displays with both graphic and alphanumeric capability, but substantial attention is given to alphanumeric crt's, plotters, and other hard copiers.

The second part discusses a number of diverse applications of computer graphics. Included are management information, architectural design and costing, and high energy physics. Unfortunately, it's difficult in words and a few photographs to convey the dynamic qualities of interactive graphics, which is its true forte. One has to have seen the real thing or one of the many movies available to appreciate the power of the techniques discussed in this part.

A one-day specialists meeting on graphics state-of-the-art followed the main symposium. Part three of the book is a brief summary by one of the editors reviewing this follow-up meeting. The paper is entitled "Present-Day Computer Graphics Research," but is concerned exclusively with development of low-cost remote display systems and software. The concentration on these fields a year and a half ago is now making itself felt on the market, as evidenced by the wide range of inexpensive display units now available.

The fourth part is a general reference section with a glossary of terms, a consolidated bibliography, and a sample of commercially available computer graphics systems. The last consists of a dozen reprints of one-page advertisements from various manufacturers, and is nowhere near the full range operational hardware.

Often, published symposium proceedings are little more than a collec-

tion of disjointed papers set in the same type. The editors of this book have taken obvious pains to avoid that pitfall. The book is well organized, with a number of closely related subjects neatly covered. This is not to say the book is without faults: the attempt to jointly cover U.S. and U.K. activities in this field, with authors from both countries, has built-in disadvantages. The use of both monetary systems (with no current exchange rate), unfamiliar abbreviations (what is the U.K.A.-E.A.?), and occasional spellings (this reviewer stumbled over draughtsman) detract from the readability. Also, some of the tutorial papers are somewhat repetitive, and the editors would have done well to adopt more internal cross-referencing.

Despite these drawbacks, the book is on the whole quite worthwhile. It offers, in one place, a quick introduction to the subject of computer graphics, with sufficient breadth that it should satisfy a newcomer with almost any specific interest. For depth, bountiful references are provided. Because of the rapid developments in this field, the useful life of this book will be no more than 2-3 years (the material was at least 18 months old when it reached this reviewer). During that time, it is recommended as a good starting point.

—ROGER D. BOURKE

## book briefs

*(For further information on the books listed here, please write directly to the publisher mentioned.)*

**Computerized Library Catalogs: Their Growth, Cost, and Utility**, by J. L. Dolby, V. J. Forsyth, and H. L. Resnikoff. The M.I.T. Press, Cambridge, Mass. 1969. \$10.00.

This book starts out with the recommendation that all but the smallest libraries should computerize their catalogs. It then goes on to explain why and how. The explanation is given in two parts: cost and utility. Beginning with an analysis of the basic cost factors involved, including cost to the user, cost of computer programming and hardware, and the cost of conversion (and making note of the hidden costs of the card catalog system), the study goes on to discuss the usefulness of computerized catalogs once installed.

For the most part, the methods used are analytical and statistical. The authors have attempted to examine the dynamic aspects of the problem. Con-

# computer careers

Should you base your career on just one interview? Make your choice from among several career positions!

## EUROPEAN and NATIONWIDE CHOICE

N.Y., N.J., NEW ENGLAND, WASHINGTON, D.C., PHILA., MINNESOTA, TEXAS, HUNTSVILLE, FLORIDA, ARIZONA, CALIFORNIA AND OTHERS

Contact us if you have some experience or interest in any of the following:

- Scientific Computation** — Data Reduction or Numerical Analysis— Unusual Outerspace/Lunar and Advanced Programs
- Software Development** — Languages, Compilers, Assemblers, Monitors or Sub-Routines
- Real Time Systems** — Message, On Line, Process Control
- Systems** — Planning, Design, Analysis of State of the Art Massive Data Handling of I.R. Systems
- Technical Representatives** — Programming and Systems support to Sales
- Digital or Logical Design**
- Management Sciences**
- Sales and Marketing**

Unique opportunities exist in the \$9000-25,000 class for Managers & Seniors and Men who can accept management responsibility and professional growth

## DIRECT SALES MARKETING

**HARDWARE & SERVICES TO \$30,000**

All expenses are assumed by our client companies.

Write in confidence, including present salary, acceptable locations or call (Collect) Mr. Nellissen (Area Code 212) PLaza 9-1720

**a&n**  
ALBERT. NELLISSEN, INC.

*Leading Consultants to Management  
in the Data Processing Field*

510 MADISON AVENUE, N.Y., N.Y. 10022  
CIRCLE 510 ON READER CARD



PROGRAMMERS/SYSTEMS ANALYSTS

# consider the advantages of a career in connecticut

Come to Connecticut and enjoy sailing on the ocean, hunting and fishing in the rolling countryside, skiing in Vermont, a day trip to New York City or historic Boston . . . golf, tennis, camping or what-have-you. It's all within easy reach when you join up with P&WA's Information Systems Department. For this is the place to combine the daily challenge of an action-oriented career in Business Information Systems with the four-season stimulation of leisure-time living in Connecticut.

Pratt & Whitney Aircraft is the world's leading producer of dependable jet engines. Now, more than ever, continuing expansion, diversification and promotion from within afford every opportunity for healthy growth and achievement for EDP professionals with up to ten years experience. Attractive openings exist at all levels of responsibility; preference will be given to applicants with recent experience using assembly language and/or COBOL.

A multiplicity of projects vary from simple card systems to complex on-line systems involving such projects as a Full Production Information System, Automated Financial Analysis and Reporting, and an Integrated Material Control System, including procurement, forecasting and scheduling. Tools include 360 models 20, 30, 40, and 50; tapes and random devices; data collection equipment; on-line facilities; DOS and OS.

*If this sounds like your kind of action, why not send your resume to Mr. H.M. Heldmann, Professional Placement, Office A-44, Pratt & Whitney Aircraft, East Hartford, Connecticut 06108. An equal opportunity employer.*

**Pratt & Whitney Aircraft**

**U  
A**  
DIVISION OF UNITED AIRCRAFT CORPORATION

## books . . .

sequently there has been a concentration of effort on the collection and analysis of statistical time series related to the growth, use, and structure of libraries.

***Proceedings of the American Society for Information Science. Volume 6: Cooperating Information Societies*, edited by Jeanne B. North. Greenwood Publishing Corp., 51 Riverside Ave., Westport, Conn. 06880. 540 pp. \$10.00.**

The 32nd annual meeting of the ASIS was held in San Francisco, from October 1-4, 1969. This volume contains all the papers accepted for presentation.

This meeting had two special objectives: (1) inclusion of participants from other professional groups with interests related to ASIS, and (2) incorporation of new techniques of information dissemination and exchange.

The papers are divided into such sections as: library automation (general, and technical processes); mechanized reference retrieval systems; classification and indexing (general, and measures of performance); microform; information centers and special libraries; information transfer networks; national and international services; user studies and communication theory; economics of providing information services and products; and file management systems. Complete author, organization, and term indexes are provided.

(For a brief report on this conference, see "The Annual ASIS Meeting," p. 183, *DATAMATION*, December, 1969.)

***A Guide for Software Documentation*, by Dorothy Walsh. Inter-Act Publication, McGraw-Hill, New York. 1969. 162 pp. \$16.50.**

In the early 1960's, Charles P. Lecht of ACT and D.C. Klick of GE devised an outline approach to software documentation. GE sponsored their research which resulted in the Documentation Templates. This book consists of a series of templates or models for writing the standard manuals and references to describe software.

A template consists of an outline of all topics required to provide user information for programming systems. The outline is supplemented by a commentary describing the content of the manual related to each topic. The templates are called models because they are not rigid nor inflexible, and are constantly brought up to date.

The book has been described by one reader as a cookbook with 14 recipes and a check list. It includes models for

preparing; a product specification; a non-conversational user's guide; a conversational operations guide; an internal logic manual; a conversational user's guide; a user's guide to a subprogram; a user's guide to a program library; an assembly language user's guide; a language processor user's guide; an I/O language user's guide; a user's guide to an operating system; an operations guide for an operating system; a generalized software information manual; and an advance information manual.

**Computer Software**, edited by Geoffrey Knight, Jr. Cambridge Communications Corp., 1612 K Street, N.W., Washington, D.C. 20006. 1968.

This book is a collection of over 4000 abstracts on programming, programs, algorithms, and simulations. Information can be retrieved by scanning the highly detailed table of contents or by checking the topic index. Each book in the series contains internal crossreferences as well as external crossreferences relating to secondary topics found in the other books in the series. Each volume will be updated periodically.

The collection is compiled from *Information Processing Journal* and is

a continuation of a previous series of books *Cumulative Computer Abstracts*. This volume is the first in a series of abstract collections; the others will be on computer applications, computer mathematics, and computer hardware. Although many subjects are covered, and the material is very accessible, the amount of information seems limited, presumably because it has been compiled from only one source.

**Computers in Mathematical Research**, edited by R. F. Churchhouse and J.-C. Herz. North-Holland Publishing Co., Amsterdam. 1968. 185 pp. \$9.

This book describes the participation of computers in mathematical research, such as performing the experimental research associated with conjectured theorems or doing tedious calculations involved in lengthy proofs. Computers are applied to such subjects as graph theory, algebra, number theory, algebraic topology, geometry, and analysis.

Fifteen papers are contained in the book, seven of which were presented at the Symposium on Utilisation of Computers in Mathematical Research, held at the IBM World Trade European Education Centre in Blaricum, Netherlands, Aug. 29-31, 1966.

**Experience and Capacity. Proceedings of the Fourth International Interdisciplinary Conference on Learning, Remembering, and Forgetting**, edited by Daniel P. Kimble. The New York Academy of Sciences, 2 East 63 Street, New York. 1968.

This conference was sponsored by the Department of the Air Force, Office of Scientific Research, and was held at Pacific Palisades, California, in October, 1966. Rather than papers, this volume consists of a series of discussions. They are on "Action Contingent Development of Vision in Neonatal Animals," led by R. Held; "Some Ways in which Experience Affects Learning," led by R. A. Hinde; "The Effects of Hormones in Infancy on Central Nervous System Organization," led by S. Levine, and an epilogue by K. H. Pribram.

**Automatic Data Processing; System/360 Edition**, by Frederic P. Brooks, Jr. and Kenneth E. Iverson. John Wiley and Sons, Inc., New York. 1969. 466 pp. \$14.50.

This text, which may be used for college upperclassmen, covers the fundamentals of data processing which are common to all applications. The author has been teaching a two-semester graduate course at Harvard since

If you could see  
the people  
CARE feeds...



...you wouldn't need  
coaxing. Mail a check.

CARE Food Crusade, New York, N.Y. 10016

## SEND US THIS MINI-RESUME:

Name \_\_\_\_\_

Home Address \_\_\_\_\_

City \_\_\_\_\_ State \_\_\_\_\_ Yrs. of Experience \_\_\_\_\_

I am considering making a change Yes  No

Position desired: \_\_\_\_\_ Salary: \$ \_\_\_\_\_

## WE'LL SEND YOU:

FREE Opportunities Bulletin listing salaries and descriptions of the best current EDP openings compiled by the nation's largest executive and professional placement organization. Check your present earnings against the going salary of the position you feel qualified to handle. (Our placements show that the average EDP professional is worth more than his current income.)

Cadillac reaches out daily to every segment of industry, coast to coast, to keep ahead of new job opportunities arising constantly in the fast-changing world of data processing. If the job you want isn't listed in our Monthly Bulletin, no organization is better qualified to help you find it—fast! Both the bulletin and our confidential service are free. Client company assumes all fees.



**LON D. BARTON, President**  
**CADILLAC ASSOCIATES, INC.\***  
32 West Randolph St. Chicago, Ill. 60601  
Financial 6-9400

West coast residents—contact:  
Lon D. Barton Associates, 3325 Wilshire Blvd.  
Los Angeles, California 90005  
(213) 385-9111

\*"Where More Executives Find Their Positions Than Anywhere Else In The World."

## books...

1954, and this book is based on his work there. The chapters can be used independently either in a classroom or for self-study, with ample references and exercises being included.

This is the second edition of this book (the first having been published in 1963) and several of the chapters have been completely rewritten to meet the needs of today's students and data processing specialists. The chapters cover: the fundamentals of dp; manual dp equipment; punched card equipment; computer coding; computer organization; programming; searching and sorting; programming systems; and system design.

**Computer-Based Information Systems for Management: A Survey**, by N. C. Churchill et al., National Association of Accountants, 505 Park Ave., New York, N.Y. 1969. 167 pp. \$4.50 for NAA members; others, \$7.50.

The NAA has initiated a program of study into computer-based systems for management. This report is the result of the initial phase of this program and explores the state of the art of com-

puter-based management information systems. It is intended both to describe how management was utilizing the computer resources and to isolate significant developments and emerging problems for future examination. The bulk of the research consisted of visits to 12 companies in eight industry-process-product classifications under the promise of company anonymity.

**Fundamental COBOL for IBM System/360**, by Robert Lloyd Jones. Prentice-Hall, Inc., Englewood Cliffs, N.J. 1969. 245 pp. \$7.50; \$5.75 paperback.

The basic concepts of COBOL are covered in this book. They can be applied to all makes and models of computers, but the examples given pertain to the IBM System/360. The object of this book is to enable the student or beginning programmer to write simple productive programs in the shortest possible time, yet enable him to advance to increased programming sophistication.

**The Systems Manual**, by Leslie H. Mathies, Systemation, Inc., P.O. Box 730, Colorado Springs, Colo. 1967. 125 pp. \$4.95.

This book concentrates on those aspects of a systems manual other than

those concerned with writing the documents. Its purpose is to determine and explain the factors involved in putting together a useful systems manual. Planning and maintaining an effective systems manual are discussed, including physical production of the manual. Basic premise of the book is that any manual must be useful to the manual holder or its production will have been largely a waste of time and money.

**The Encyclopedia of Library and Information Science, Volume 2: Associat. to Book World**, edited by Allen Kent and Harold Lancour. Marcel Dekker, New York. 1969. \$35.00 subscription price per volume; \$45.00 single-volume price. This 18-volume encyclopedia combines both theory and practice of the two fields, library science and information science, in the United States and abroad. Subjects, concerned with the present practices and backgrounds of the fields of librarianship and documentation, are arranged alphabetically. Cross-references are provided, and most articles have extensive reference sections and/or bibliographies. The encyclopedia is intended to serve librarians, information scientists, computer scientists, advanced students, and researchers in related fields.



### YOU DON'T HAVE TO TAP A TELEPHONE WIRE TO FIND OUT HOW YOU COMPARE WITH YOUR CONTEMPORARIES

The Callahan Center, with offices in Philadelphia and California, has accumulated many facts over the past four years in placing computer professionals all over the country and overseas. We would like to share them with you.

Now you can determine exactly how you compare with your contemporaries. This FREE 1970 edition lists typical backgrounds of professionals in the EDP field. This includes their year of graduation, a description of their experience, (including Machines, Languages, and Applications), their present salary and bona fide offers.

Find out where you stand. Write for this free booklet now.

FREE



All of our services are employer paid.

**Callahan**

**CENTER FOR COMPUTER PROFESSIONALS**

1819 John F. Kennedy Blvd., Phila., Pa. 19103 • 215-561-1950

Western Office: Del Almo Financial Center  
Torrance, Calif. • 213-371-4659

## Systemation Consultants, Inc.

Houston - New York

### Software Systems

Three highly respected client companies in Dallas, Los Angeles and Houston have outstanding software systems opportunities requiring creative Assembler/Machine language experience in the design and implementation of new multicomputer systems software, Operating Systems, compiler development, real time executive, monitor, control panel level software, message switching, etc. This software will be used for such applications as time sharing, process control, teleprocessing, etc. The above growth companies offer exceptional experience and individual opportunities within accomplishment oriented environments. Starting salaries to \$19,000 range.

### Process Control

Aggressively expanding medium sized company seeks ChE or EE with computer process control/data acquisition applications experience (DDC or Supervisory) in chemical/oil industries. This senior systems engineering opportunity offers program management responsibility as well as a cross section of applications experience. Prefer strong software development experience as well as hardware capabilities appreciation. Stock options plus starting salary to \$18,000 range—Houston.

### Systems Manager — Banking

One of the most rapidly expanding growth companies in their industry seeks manager of uncommon enterprise. To assume line responsibilities for systems design, programming, and operations supervision in banking as well as other corporate business applications. Attractive incentives based on systems department profits plus starting salary to \$20,000—Southwest.

We are an established recruiting and consulting firm whose prime function is to put capable professionals in touch with progressive manufacturing, service, and consulting companies having exceptional employment opportunities. Senior and junior positions are available in engineering and within the computer hardware and software functions of systems management, systems design/programming, marketing, Operations Research, and other associated activities. Our clients include companies operating in a cross section of profitable commercial and scientific activities in various domestic and international locations. Each contact is made selectively and held in strict confidence. Our client companies assume all placement fees. Send resume in confidence or request our resume form, and our Houston Director—J. L. Gresham, BChE, MBA —will call you at home one evening to discuss your specific objectives and interests.

Post Oak Tower

Houston, Texas 77027

622-1370

# Dynamic 1970 opportunities for computer professionals.

## And the salaries they command.

It's in the all new and expanded 1970 edition of our  
Computer Salary Survey and Career Planning Guide.  
And it's free.

Included are: salaries broken down into 28 levels of  
professional and management classifications, ranging up to  
\$75,000; for the first time, a comprehensive review of  
the new and growing computer services industry  
(facilities management, time sharing, systems engineering  
services, software development, education); effects  
of unbundling; analysis of positions and industries; how  
and when to change your job and plan your career.

Information in this 10,000-word report was compiled  
and analyzed by the experts at Source EDP—the largest  
nationwide recruiting firm devoted solely to the computer  
professional. To speed delivery of your free copy, write your  
nearest Source EDP office. Or circle the reader inquiry card.

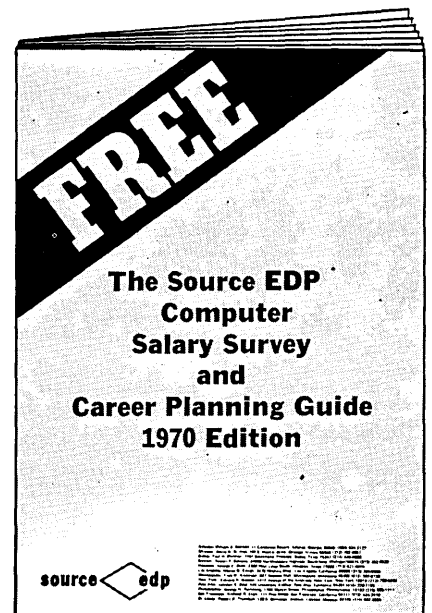

Atlanta—William G. Barnett, 11 Corporate Square 30329, (404) 634-5127  
Chicago—David D. Grimes, 100 S. Wacker Drive 60606, (312) 782-0857  
Dallas—Paul E. Dittmer, 7701 Stemmons Freeway 75247, (214) 638-4080  
Detroit—Robert T. Stevens, 24500 Northwestern Highway,  
Southfield, Mich. 48075, (313) 352-6520  
Houston—George V. Dyer, 2300 W. Loop S. 77027, (713) 621-6070  
Los Angeles—Wayne B. Emigh, 3550 Wilshire Blvd. 90005, (213) 386-5500  
Minneapolis—Fred N. Anderson, 801 Nicollet Mall 55402, (612) 332-8735  
New Jersey, Union—Daniel A. Mickel, 2204 Morris 07083, (201) 687-8700  
New York—Edward T. Golden, 1414 Avenue of the Americas 10019, (212) 752-8260  
Palo Alto—Gordon F. Best, 525 University Ave. 94301, (415) 328-7155  
Philadelphia—George P. Ramming, 1700 Market Street 19103, (215) 665-1717  
St. Louis—Robert H. Trumbull, 130 S. Bemiston, Clayton 63105, (314) 862-3800  
San Francisco—Richard M. Clark, 111 Pine Street 94111, (415) 434-2410  
Also associates in the United Kingdom

source  edp

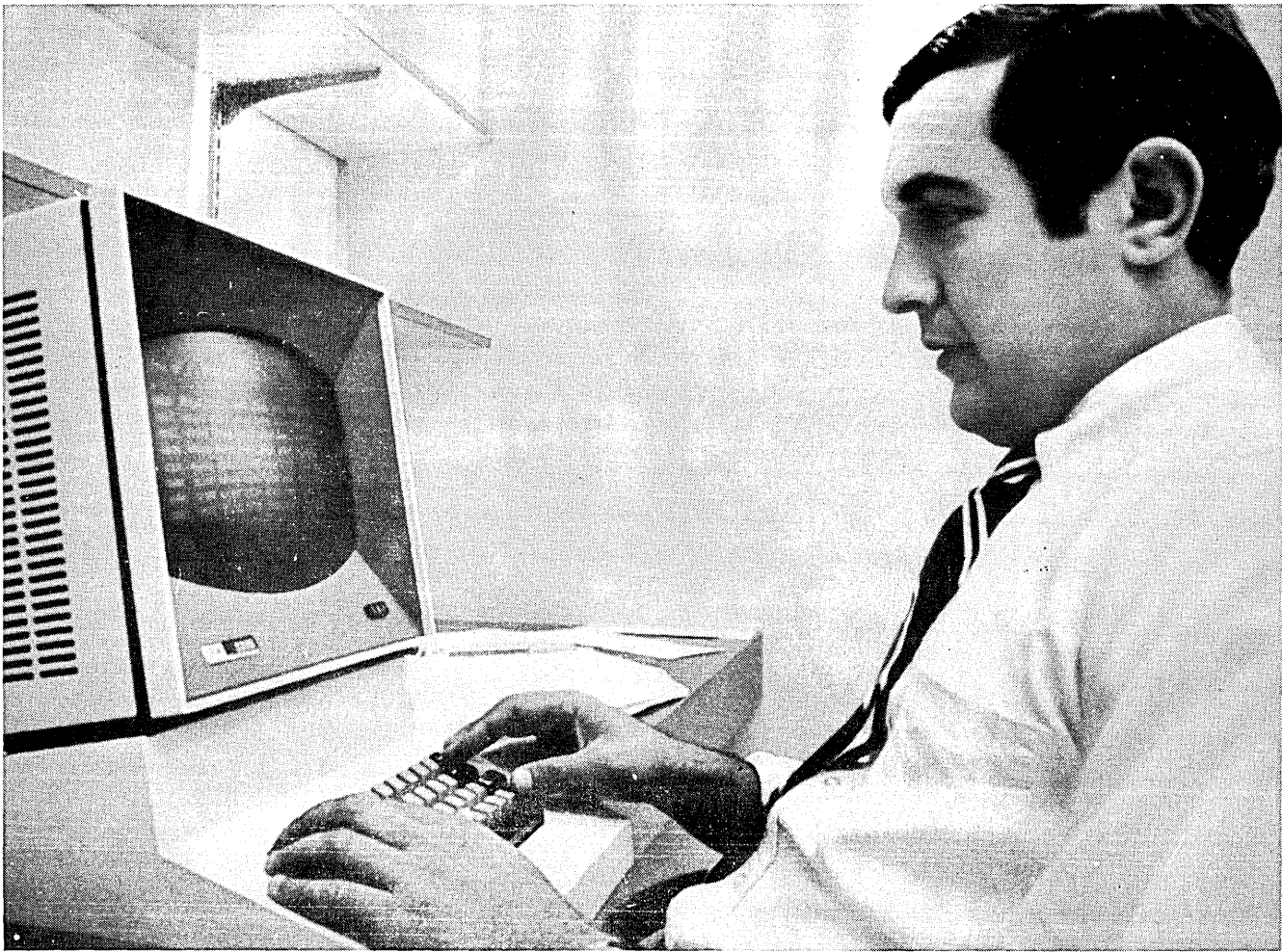

## Systems Programmers/Analysts: Give IBM a hand and we'll try to make it a free one

If predictable thinking were what we wanted, we'd just program it. But what we're looking for are imagination and ingenuity.

If you have these qualities, and you qualify for a job with IBM, you can be sure you'll get to use them.

### Immediate openings

There are openings for Programmers/Analysts and Systems Programmers at IBM Endicott, New York, where we develop and manufacture logic circuits and computer systems.

### What you'd do

You'd design and test application programs for our new Information Systems. These systems will aid manufacturing and production planning functions at all IBM facilities.

You will be involved with real-time and on-line processing applications, using IBM System/360 programming.

A Bachelor's degree and at least one year's

experience are required. You should have a knowledge of basic assembler language and large-scale computer concepts.

### Company-paid benefits

IBM offers a wide range of benefits—company-paid.

And you could take advantage of our Tuition Refund Program to help further your education in colleges and universities in the area.

### Call or write

Call Dom Santoni collect at (607) 755-2855. Or write to him at IBM Corp., Dept. DB1008, 1701 N. St., Endicott, N.Y. 13760.

### An Equal Opportunity Employer

# IBM®

# CAREERS

COAST TO COAST  
EUROPE

# TOP 20%

### EXCLUSIVE!

The unique personal and confidential relationship we establish with you and our clients permits us to offer you outstanding job opportunities, many not found anywhere else. If your potential or abilities are above average and you are looking for a challenge, our unique service provides 49 state and international coverage.

### OUR CURRENT TOP 3 NEEDS:

1. SALES — HARDWARE or SERVICES  
Managers, Seniors, Juniors
2. SOFTWARE DEVELOPMENT  
Compilers, O/S, Executives
3. REAL-TIME SYSTEMS  
Time-Sharing, Process Control

### OTHERS — Junior to V.P. Levels:

- Management/Computer Consulting
- O.R. Management Sciences
- Computerized Process Control
- Management Information Systems
- Systems Planning/Development
- Business Systems, Programming
- Applied Mathematics
- Scientific Computation
- Logic/Digital/Circuit Design
- Software/Applications Packages

SALARIES \$10,000-\$35,000

Our clients assume all expenses  
Call collect or write in full confidence to  
George Kostecki 212/695-5214  
Director Career Development  
Offices:

855 Avenue of the Americas, New York, N. Y. 10001  
5710 West Manchester Boulevard,  
Los Angeles, Calif. 90045  
Corporate Headquarters, Santa Fe, N. M.  
Joseph Albert, President

Indicate salary and geographic requirements



Member ACM; Career Consultants in the EDP Field  
CIRCLE 509 ON READER CARD

February 1970

## letters...

ready availability was something else again, for it seemed that not many people felt about it as I did.

The sc-4020 accepted specially formatted mag tape and generated characters from the 64-character matrix (typewriter mode), or by building up vectors, or by building up dots. We never used the last technique because we found the resulting resolution the poorest of the three. Also, because of the computer industry's tiresome preoccupation with capital letters, we were compelled to design our own lower-case matrix. Capital letters and other characters of relatively low frequency were relegated to being generated by vectors. Thus we produced the manuscript ("microscript?") for *The Unabridged Edition of The Random House Dictionary of the English Language*.

The implications of COM for automatic typesetting are important. Several input coding devices recently put on the market offer neither hard copy nor crt display capability to enable the keyboarder to be aware of what degree of identity there may be between what is actually being keyboarded and what is actually being produced.

COM to the rescue! Using the sc-4020, we produced the entire text of the RHDEL (the dictionary section) on microfilm in seven hours at a cost of less than \$1000. Normally, today's publisher can stop there, provide each proofreader with a microfilm viewer and a coded access system, and update the manuscript as required. But in 1965, when the state of the art of graphic arts automatic typesetters was still too primitive to accommodate the exigencies of the RHDEL, we were compelled to produce a complete typescript to the Monotype compositors who (Woe is me!) keyboarded the entire text anew. Using the vector mode, we could have generated every character in each font; but when you consider that every vector in each letter required the formatting of a computer word, and you calculate the number of vectors required to generate an entire italic font, you realize that the computer time for formatting, the machine time for generating, and the very numbers of tape reels required would become prohibitively expensive compared, say, with the cost of running a straight line under those roman characters that were to be set in italic. By the use of such simple devices, which are readily understood by compositors and proofreaders as an accepted convention, we were able to keep costs very low, even when you add in the \$3000 we had to pay for the

# EDP DREW & YOU

...that's the 3-pari program that spells success in data processing. New York and Chicago offer rapid advancement because there's a critical shortage of Programmer Analysts with salaries from \$8,000 to \$25,000. YOUR skills are needed and wanted.

DREW, the largest EDP personnel placement organization in New York and Chicago, is in constant touch with hundreds of nationally known corporations. Here's how we tell you about them: When your resume is on file, with us we call you wherever you are in the U.S. and give you full information on jobs suited to your abilities and background. Opportunity doesn't knock — it rings!



Scores of major companies look to Drew to provide EDP personnel in the areas of applications programming, systems programming, systems design, software systems and management information systems.

### TO START DREW WORKING FOR YOU

Simply send us this coupon or your resume. We'll take it from there—start immediately to match your skills with job openings on file and coming in every day, call you on the phone to discuss salaries offered, responsibilities—and everything you need to know to grow in EDP. Drew will arrange for a client company to fly you in for a personal interview at no cost to you. Everything will be handled in confidence, of course. Let's get started—send your resume today.



NAME \_\_\_\_\_

PHONE \_\_\_\_\_

HOME ADDRESS

street \_\_\_\_\_

city \_\_\_\_\_ state \_\_\_\_\_ zip \_\_\_\_\_

GEOGRAPHIC AND JOB PREFERENCES:

EDUCATION (list highest degree first)

Mail this today to:

## DREW

Personnel Placement Center  
160 Broadway, New York, New York 10038  
(212) 964-8150

333 North Michigan Ave.  
Chicago, Illinois 60601  
(312) 641-2580

CIRCLE 501 ON READER CARD



# HARDWARE CAREERS

- MANAGER, Memory Systems . . . to 20K
- MANAGER, Logic Design . . . to 21K
- MANAGER, Data Communications to 20K
- Circuit Design . . . 12-16K
- Logic Design . . . 12-16K
- Memory Systems Design . . . 12-17K
- Magnetic Recording Techniques 13-17K
- Systems Architecture . . . to 21K
- Manufacturing Process Engrg. . . 12-19K
- Power Supply Des or Mfg . . . 12-18K

# SOFTWARE CAREERS

- MANAGER, Compiler Development to 21K
- MANAGER, Software Development to 23K
- Senior Programmer 360/50 & up, COBOL, QTAM. . . 11-16K
- Programmer/Analyst 360/30 & up, COBOL, BAL. . . 11-16K
- Senior Specialist 360/30 & up, COBOL, BAL. . . 13-17K
- RT Message Switching Systems to 18K
- Compiler Development to 16K
- Conversion Techniques to 16K
- Sort Techniques . . . to 18K
- Design Automation . . . to 20K
- Product Planning . . . 15-24K

## PRINCIPAL LOCATIONS

BOSTON  
GREATER NYC  
UPSTATE NEW YORK  
CONNECTICUT  
WASHINGTON DC  
SAN FRANCISCO BAY  
LOS ANGELES AREA  
ARIZONA  
FLORIDA  
CHICAGO  
MINNEAPOLIS/ST. PAUL  
DETROIT/ANN ARBOR

All fees and interview expenses are paid by client companies.

Send resume, brief letter or your business card, or circle reader service card. We will call you within 24 hours to discuss your interests.

Contact:  
R. W. Reilly

## RESOURCES Objectives, Inc.

1 Militia Drive  
Lexington, Mass. 02173  
(617) 862-6200

CIRCLE ON READER CARD

CIRCLE 526 ON READER CARD

## letters . . .

special-matrix Charactron tube.

To produce a typescript, we ran the microfilm through a Xerox Copyflo machine, ending up with 21,000 pages on a web. This was then sliced and bound into 70-odd binders. The editors were happy and the compositors were happy.

Although most of the advantages of using computers redounded to the benefit of the editorial systems and not to the manufacturing department, while the final tapes were being run through the sc-4020 format run, we counted all of the characters in the book and tallied each one in each font. Since we used more than 450 characters and the Monotype matrix could contain only 315 or thereabouts, this frequency count enabled the compositor to decide, without resorting to expensive cast-offs and counts, exactly which characters could most economically be included in and excluded from the matrix.

So, what's all the fuss about com? It's a great system, but hardly new. What we need now are some well-organized, versatile, input keyboards that provide hard copy or a display that is readable by human beings and that makes some semblance of reproducing the characters intended. But that's a subject for another letter.

LAURENCE URDANG  
*Chester, Connecticut*

Ed. note: Mr. Urdang, formerly managing editor of the Unabridged Edition of the Random House Dictionary, is currently a consultant to publishers and compositors.

## stretching it

Sir:

You have made me feel very unhappy and old. In your article on Bill Mow (Dec. p. 198), you felt it necessary to add a footnote describing the STRETCH. I presume you meant 1959 rather than 1969. At any rate I puzzled over why the footnote was added and then realized there must be thousands of people in the industry that have no idea what it was. CSA, ironically, is currently trying to find a user for the Livermore STRETCH rather than scrap or auction it.

Maybe you also remember when DATAMATION was a bimonthly and rather thin publication.

Best wishes as the 70's descend upon us.

TERRY MILLER  
*Alexandria, Virginia*

Ed. note: Thank you. STRETCH's first delivery was in 1961. And we know about feeling old, too. In July, our monthly publishing cycle will be a thing of the past as we go to 24 times a year.

# select the BEST... select from the MOST

At Robert Half our procedures are efficient, quick and confidential. We are the largest specialists in the Financial and EDP placement field, and we therefore have access to the most positions within this concentrated area of employment. . . . and from the most we carefully select the best. . . . for you.

It makes no difference whether your requirements are local, regional, national or international. . . . if it has to do with

Financial or EDP employment, we are best equipped to serve you through our extensive files, resources and intensive knowledge of our specialization.

We succeed on merit alone.

Our fees are earned only when we actually make the placement, and all fees are paid by management.

**The most Financial and EDP positions  
The most Financial and EDP people**

## ROBERT HALF PERSONNEL AGENCIES

Atlanta: 235 Peachtree St., NE . . . . . (404) 688-2300  
Baltimore: The Quadrangle-Cross Keys . . . (301) 323-7770  
Boston: 140 Federal St. . . . . (617) 423-6440  
Chicago: 333 N. Michigan Ave. . . . . (312) 782-6930  
Cincinnati: 606 Terrace Hilton . . . . . (513) 621-7711  
Cleveland: 1367 E. 6th St. . . . . (216) 621-0670  
Dallas: 1170 Hartford Bldg. . . . . (214) 742-9171  
Detroit: 1114 Guardian Bldg. . . . . (313) 961-5430  
Garden City, N.Y. 585 Stewart Ave. . . . . (516) 248-1234  
Hartford, Conn: 75 Pearl St. . . . . (203) 278-7170  
Houston: 1200 Central Nat'l Bank Bldg. . . (713) 228-0056  
Indianapolis: 9 N. Illinois St. . . . . (317) 636-5441  
Los Angeles: 3600 Wilshire Blvd. . . . . (213) 381-7974  
Miami: 1107 Northeast Airlines Bldg. . . . (305) 377-8728  
Minneapolis: 822 Marquette Ave. . . . . (612) 336-8636  
New York: 330 Madison Ave. . . . . (212) 986-1300  
Newark: 1180 Raymond Blvd. . . . . (201) 623-3661  
Philadelphia: 2 Penn Center Plaza . . . . (215) 568-4580  
Phoenix: 1517 Del Webb TowneHouse . . . (602) 279-1688  
Pittsburgh: 429 Forbes Ave. . . . . (412) 471-5946  
Portland, Ore: 610 S.W. Alder St. . . . . (503) 222-9778  
St. Louis: 1015 Locust St. . . . . (314) 231-0114  
San Diego: 707 Broadway . . . . . (714) 234-1896  
San Francisco: 111 Pine St. . . . . (415) 434-1900  
San Jose: 675 North First St. . . . . (408) 293-9040  
Stamford, Conn: 111 Prospect St. . . . . (203) 325-4158  
Washington: 7316 Wisconsin Ave., N.W. . . (301) 654-1850

CIRCLE 505 ON READER CARD

**DATAMATION**

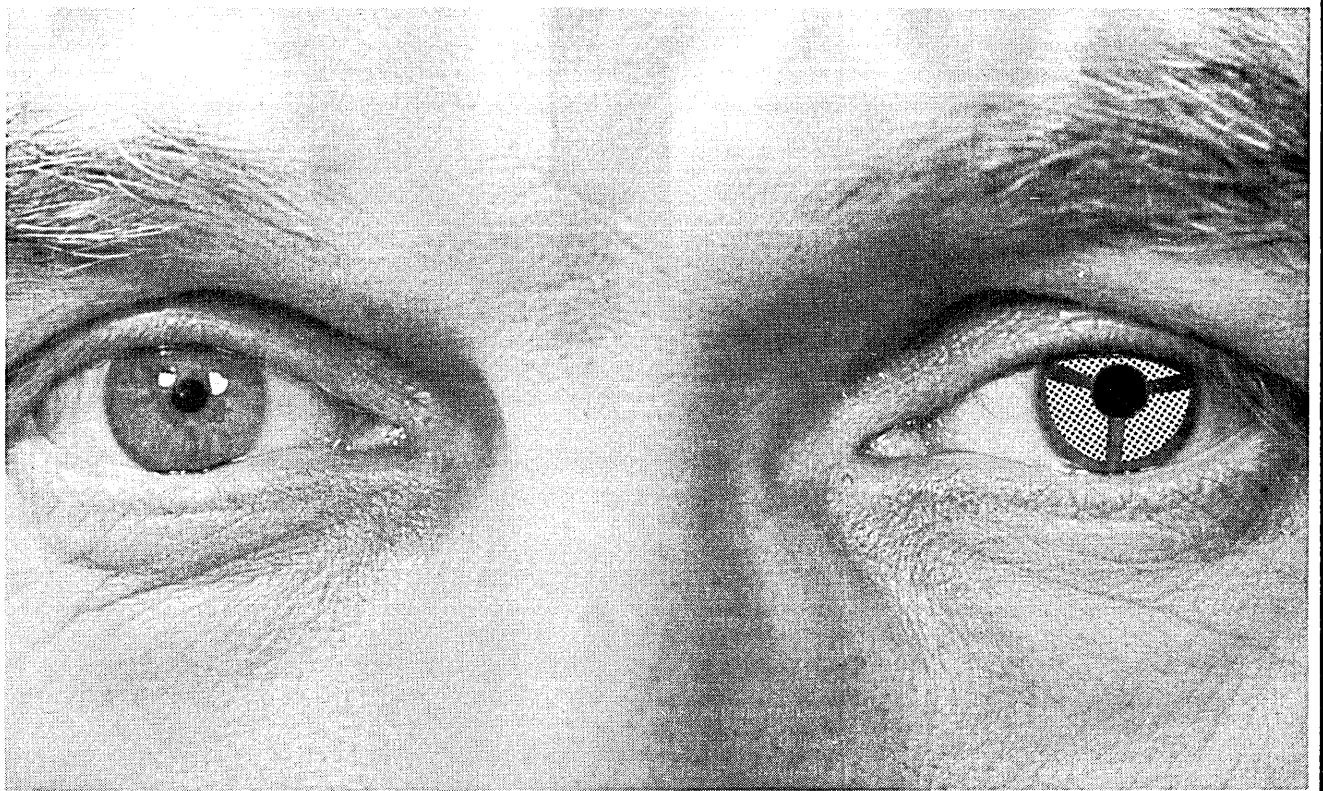

## KEEP AN EYE ON TOMORROW...

We are a national corporation with assets of 70 million dollars and are looking for qualified **SYSTEMS ANALYSTS** to work in our expanding Data Processing Department.

**SYSTEMS ANALYST**, acting in a control function for the development of an insurance processing system.

**PROJECT MANAGER** for the development of a total insurance processing system. Line responsibility for approx. 4 technical people.

**SYSTEMS ANALYST**, acting in a control function for the development of a processing system.

**GENERAL ANALYSTS** to help develop a Financial Information Reporting System.

**METHODS SYSTEMS ANALYST** to develop programs involving manual procedures and methods planning.

We also have several challenging openings for qualified programmers.

We will pay all moving and relocation expenses. We offer a truly top starting salary and comprehensive benefits.

Write or send resume, in confidence, including education, experience and salary history to the attention of **BILL KIPP**.

american reserve corporation

65 E. South Water Street • Chicago, Ill. 60601

# 1970

## **Sales Engineers Software Specialists Computer Field Engineers**

**the DECade is just  
beginning. make  
the most of it.**

If Digital Equipment Corporation's past ten years are any indication of the future, and we believe they are, the 1970's should be exciting.

Digital started just twelve years ago. Today, we're a dominant force in the small to medium scientific computer markets, and a leader in large scale time sharing applications. In terms of numbers of installed computers, Digital is the third ranking computer manufacturer in the world, and continues to be the world's leading manufacturing supplier of logic modules. Sales in the last half-DECade have increased by over 500% to more than 88 million dollars in fiscal 1969. This sales pace is being achieved with business that is ninety percent commercially oriented.

Where will we be ten years from now? Much of that depends on our field organization of sales engineers, software specialists, and service engineers. Professionals who can assist our present customers in the use of DEC equipment and recommend Digital Equipment Corporation systems that will meet the needs of prospective customers.

We depend on men who want individual involvement and technical challenge.

The positions listed below require nothing but the best people. If you're one, keep reading — the DECade is just beginning.

### **SALES ENGINEERS**

To apply modules and computers to new and/or very singular systems requirements. These positions involve matching our many products to a wide range of needs, analyzing systems requirements, configuring and pricing, and full responsibility for servicing accounts.

Types of applications include communications, process control, physics, data acquisition, both analog and digital, and peripheral interfacing.

A technical degree is required with two or more years experience in computer engineering, marketing or sales.

Positions are open in several major cities throughout the U.S.

### **SOFTWARE SPECIALISTS**

To provide pre- and post-sale customer support for the installation, use and modification of DEC supplied software for our complete line of PDP computers. A BS in math or computer science, or the equivalent, is required plus a background in assembly language programming. Also desirable is time sharing software knowledge, operating system coding experience plus real-time programming experience.

### **COMPUTER FIELD ENGINEERS**

Successful candidates must possess a minimum of one year's maintenance experience on any make of digital central processors and its associated peripheral equipment (tapes, punches, readers, printers, teletypes, etc.). Your responsibilities will include the installation, preventive and corrective maintenance of Digital's highly successful PDP computer systems.

Forward your resume to Mr. P. T. Koch, Supervisor, Professional Personnel, Department 100, Digital Equipment Corporation, 149 Main Street, Maynard, Massachusetts 01754. Digital is an equal opportunity employer.

**digital**



# advertisers' index

A.C. Manufacturing Co. ....	205
ACCO .....	19
Adage Computer Graphics .....	22
Addison-Wesley Publishing Company, Inc. ....	244
Advanced Memory Systems, Inc. ....	218
Advanced Space Age Products, Inc. ....	50
Albert Associates .....	261
Albert, Nellissen, Inc. ....	255
American Data Systems .....	105
American Reserve Corporation .....	263
American Technological Institute .....	250
Ann Arbor Computer Corporation, A Subsidiary of the Jervis B. Webb Company .....	204
Applied Data Research, Inc. ....	5
Applied Digital Data Systems, Inc. ....	190, 191
Applied Logic Corporation .....	55
Astrodata Inc. ....	112, 113
Audio Devices, Inc. ....	115, 116, 117, 118

Auerbach Info, Inc. ....	214
Austin Systems Co. Inc. ....	216
Avtel Corporation .....	86
Bell Labs .....	122
The Bendix, Advanced Products Division .....	17
Burroughs .....	48
Cadillac Associates, Inc. ....	257
California Computer Products, Inc. ....	18
Callahan Center for Computer Professionals .....	258
C-E-I-R Inc., The Professional Services Subsidiary of Control Data Corporation .....	156
The Chase Manhattan Bank .....	251
Clary Datacomp Systems, Inc. ....	90
Comcet, Inc. ....	100, 101
Compat Corporation .....	136
Computer Development .....	157
Computer Devices Corporation .....	146
Computer Memory Devices .....	217
Computer Optics Inc. ....	129
Computer Peripherals Corp. ....	111
Computer Terminal Corporation .....	160

## EDP SEARCH

**SHOULD YOU CONSIDER A CHANGE?  
MOST PROFESSIONAL EDP PEOPLE DO.  
HERE IS WHY FOX-MORRIS IS  
THEIR FIRST CHOICE:**

A recognized staff of professional experts offering LOCAL, REGIONAL & NATIONAL COVERAGE through our direct branches (Phila., New York City & Wilmington) as well as coast to coast coverage throughout the USA. Completely confidential service.

Unparalleled contacts with industry based on years of successful results. Professional resume evaluation and career guidance.

Client companies assume all employment costs—including interview expense, relocation (if necessary) and search fee.

SEND RESUME DIRECT, OR CIRCLE NUMBER BELOW ON READER CARD.

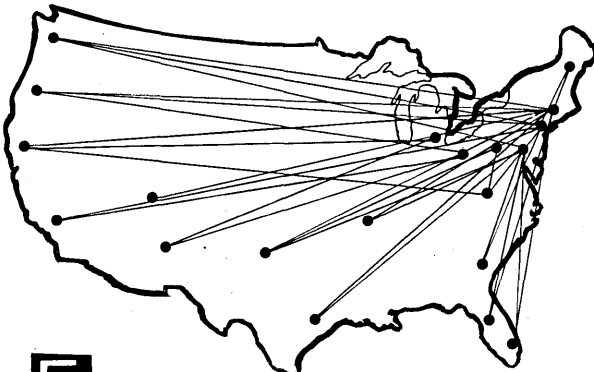

**FOX-MORRIS ASSOCIATES**  
*Personnel Consultants*

All replies to J. J. Shields:

PHILADELPHIA: 1500 Chestnut Street, Philadelphia, Pa. 19102

Pan Am Building, 200 Park Avenue, New York, N.Y. 10017

2115 Concord Pike, Wilmington, Del. 19803

## HARDWARE DESIGNERS OPTICAL CHARACTER RECOGNITION MINNEAPOLIS LOCATION

Computer peripherals are booming—and so can your career if you can contribute to Honeywell's growth by developing Optical Character Recognition equipment. The Communications and Data Products Division, a brand new division of "The Other Computer Company", needs experienced professionals as listed below. If you can qualify, we offer ground floor opportunity and unlimited potential in beautiful Minneapolis.

**Transport Servo Designers**—Degree and five years experience in design of paper feeding, transporting and positioning machines, utilizing mechanical, electronic, optical and pneumatic subsystems. Prefer direct OCR experience.

**Special Video Processing Designers**—Degree and five years experience in development of video scanning applications. Must be familiar with non-standard sweep techniques and timing circuits, plus applications of sensor tubes.

**Digital Designers**—Degree and four years of commercial electronics design. First preference to direct experience in OCR logic (pre-processing, recognition and control).

**Production Liaison Engineers**—Degree and five years experience in layout, tooling, and production of peripherals. Prefer commercial equipment experience.

**Manager—Design and Development**—Degree and five years management experience in commercial industry required. Prefer direct OCR experience. Will have responsibility for design, fabrication and assembly of OCR machines.

Other immediate openings in Supervision, Reliability and Maintainability exist, making your OCR experience your most valuable asset. All salaries commensurate with education and experience. Call Bill Megarry collect at 612/332-5200, extension 2636 or submit a resume in confidence to

M. D. Wanvig  
2701 Fourth Avenue South, Minneapolis, Minnesota 55408

**HONEYWELL**

An Equal Opportunity Employer

CIRCLE 515 ON READER CARD

CIRCLE 506 ON READER CARD

**ANALYSTS  
PROGRAMMERS  
SYSTEMS PROGRAMMERS**

# help write the book on management information systems

... IN CONNECTICUT

If you're ready for a wide-open career, consider this.

Finding the answers to mass transportation is a dynamic growth situation at Sikorsky. Right now, we're designing and building tomorrow's helicopters. Unique aircraft like our SKYCRANES . . . with an 18-ton lift capability. Or sleek, Vertical Take-Off and Landing Vehicles to transport people in airliner comfort to and from congested airports.

We'll need new, greatly expanded Management Information Systems to back up these years-ahead programs. And EDP people with financial, manufacturing or administrative experience to insure their success. We need *all* kinds of people—at *all* levels of experience. People who enjoy working on

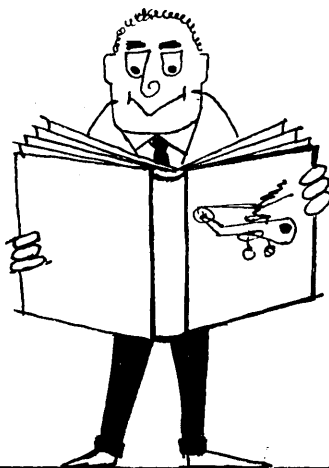

**Sikorsky  
Aircraft**  
U  
A  
DIVISION OF UNITED AIRCRAFT CORPORATION  
STRATFORD, CONNECTICUT  
An Equal Opportunity Employer

standard batch applications. Or people who relish the challenge of graphics, teleprocessing and time-sharing. And people with interests in-between. Naturally, a knowledge of COBOL and/or assembler language would be an important consideration.

You'll like our environment. We pay well. There are friendly, talented people to work with. The tools you need to work with are here—including system 360 models.

And Connecticut living with its cultural and recreational facilities can be abundantly satisfying.

So, if you feel you qualify, get in touch. For a prompt response, air mail your resume, stating salary requirements, to:

MR. LEO D. SHALVOY,  
PROFESSIONAL EMPLOYMENT

## advertisers' index...

Computerbase Corporation .....	174	Digitek Corporation .....	226
Control Data Corporation .....	147, 148, 149	Discom Incorporated .....	215
Consolidated Analysis Centers Inc. ....	229	Dresser Systems, Inc. ....	238
Courier Terminal Systems, Inc. ....	194	Drew Personnel Placement Center .....	261
Daconics .....	206	EG&G, Inc., Systems Development Division .....	198, 199
Daedalus Computer Products, Inc. ....	21	Electronic Computer Programming Institute .....	138
Dasa Corporation .....	78	Electronic Memories .....	14, 15
Data Action .....	202, 203	EMR Computer, EMR Division of Weston Instruments, Inc. .	151
Data Dimensions, Inc. ....	268	Evans & Sutherland Computer Corporation .....	124
Data Enterprises, Inc. ....	216	Foto-Mem, Inc. ....	162
Data General .....	20	Fox-Morris Associates .....	265
Data Printer Corp. ....	236	GAF Corporation, Office Systems Division .....	224
Data Products .....	140	General Automation, Inc. ....	178
Data Research Corporation .....	194	General Motors Research Laboratories .....	253
Datacraft .....	130	Gould Inc., Graphics Division .....	46, 47
Dataline Inc. ....	207	Graphic Data, Inc. ....	200
Datalog Division Litton Industries .....	228	Robert Half Personnel Agencies .....	262
Datapro Research, A Division of Computer Conversions, Inc. ....	210	Philip Hankins Incorporated .....	16
DATAMATION Magazine .....	247	Hewlett Packard .....	30, 31, 58
Datamax Corporation .....	13		
Datatrol Inc. ....	227		
Digital Equipment Corporation .....	6, 40, 264		

## DIRECTOR OF ENGINEERING

We are seeking a dynamic manager with a proven record of accomplishment. The individual must have 15 to 20 years experience in computer hardware development with a minimum of 5 years in a technical management capacity. Some software experience would be helpful. M.S.E.E. is a minimum; Ph.D. preferred. Responsible for the direction of all company hardware development activities. Reports to the chief executive officer. We offer you the challenge and resources in the development of medium-scale computers, instruments, systems and peripheral equipment for a young and dynamic computer company with five-year operating experience. An exceptional stock option is intended to attract the very best in the industry. Please submit your resume in confidence to Mr. James T. Chao, president.



**INFORMATION TECHNOLOGY, INC.**  
164 WOLFE ROAD • SUNNYVALE, CALIFORNIA 94086  
(AN EQUAL OPPORTUNITY EMPLOYER)

CIRCLE 531 ON READER CARD

February 1970

## CAREER MEMO

To **PROGRAMMERS/ANALYSTS/ENGINEERS**  
From **EVERETT KELLEY ASSOCIATES, INC.**

If your present position lacks professional motivation . . . NOW is the time to let us program your professional future . . .

Consult our staff of experienced specialists who are at your disposal. They will open doors and arrange favorable interviews with selected clients. Utilize your total professional capability in:

- Scientific Programming
- Real Time Systems
- Software Development
- Operations Research
- Applied Systems
- Systems Design
- Consulting
- Digital or Logic Design
- Circuit Design
- Commercial Programming
- Mathematics
- Development Engineering
- Communications
- Sales/Marketing

Salary range: \$8,000-\$30,000. All expenses paid by client companies (fees, interviewing and relocation).

Submit your resume in strict confidence, including salary requirements and geographic preference, directly to Mr. R. L. Keilholtz or Mr. Donald Wayne or write for our composite resume form A.



**EVERETT KELLEY  
ASSOCIATES**

Consultants to the  
Computer Industry

121 So. Broad Street (Suite 1300)  
Philadelphia, Pa. 19107

Placement of Computer Professionals since Binac.



CIRCLE 517 ON READER CARD

267



**If you just got a \$2500 raise,  
got promoted to DP manager  
or got another thousand shares,  
maybe it's time to quit.**

**Maybe it's time to see Stan Closman.**



Stan is now in New York City.

Stan is a perfect personnel man. Because he's never been a personnel man.

He wouldn't know a Rorschach from a coffee stain. He doesn't believe in aptitude tests. He refuses just to collect and forward resumes.

Stan simply knows about the top DP jobs because he knows the top DP people. He came up as a mathematician and technical manager at IBM. And for seven years he was IBM's manager of users' groups—their primary feedback channel from SHARE, GUIDE and COMMON. So he knows more about QTAM and MVT than he does about PAT.

Stan can tell in an hour interview whether you should be a top DP manager. Whether you can fill a 25K systems job. Whether you're one of the key professionals or executives his clients—really his associates—are looking for.

If you're not, he may tell you to stay where you are. Or to see a personnel man.

But maybe he'll tell you why it's time to quit.

Call or write—in confidence—to Stan Closman, Director,  
Personnel Services Division,  
Data Dimensions, Inc.,  
60 East 42nd Street,  
New York, N.Y. 10017  
(212) 687-2030.



**Data Dimensions, Inc.**

## advertisers' index...

Honeywell	84, 85, 152, 153, 265
Honeywell, Computer Control Division	232
Houston Instrument, Division of Bausch & Lomb	142
IBM	260
Inforex, Inc.	168, 169
Information Data Systems Inc.	225
Information Technology, Inc.	267
Infoton Incorporated	222
Inter-Act Corporation, Education and Publications Subsidiary of Advanced Computer Techniques Corporation	243
Interdata	95
Intermec	173
Iomec Inc.	134
Everett Kelley Associates	267
Keyboard Training Incorporated	166
Lockheed-California Company, A Division of Lockheed Aircraft Corporation	270
Lockheed Electronics Company, A Division of Lockheed Aircraft Corporation	25
Lockheed Missiles & Space Company, A Group Division of Lockheed Aircraft Corporation	252

Loeb, Rhoades & Co.	242
Logic Corporation	28
MAI Equipment Corporation	107
Magnafile, Inc.	42
Magnetic Shield Division, Perfection Mica Company	212
McGraw-Hill Book Company	4
Memorex	180, 181, 183
Methods Research Corp.	243
Micro Switch, A Division of Honeywell	234
Monarch Marking Systems, A Subsidiary of Pitney Bowes	185
Moore Business Forms, Inc.	135
Motorola Instrumentation & Control, Inc., Subsidiary of Motorola, Inc.	44
National Blank Book Company, Inc.	26, 27
The National Cash Register Company	12, 269
National Computing Industries	24
Nortec Computer Devices Inc.	29
North Electric, Electronics Division	220, 221
Parker-Finch Associates, Inc.	245
PerSyst Inc.	269
Planning Research Corporation	154
Potter Instrument Company, Inc.	144
Pratt & Whitney Aircraft, Division of United Aircraft Corporation	256

# NCR

## SYSTEMS DESIGN/PROGRAMMERS

Expansion has created several outstanding opportunities for qualified individuals in the On-Line/Real-Time field.

After an extensive training period, your duties would include assistance to NCR field personnel and customers to insure successful On-Line/Real-Time installations, the conduction of seminars and workshops for NCR customers and aid of hardware specialists in determining the source of hardware failures. There would also be limited travel.

If you have two or more years of systems design and programming experience and desire to join a company alive with new ideas, send your letter or resume to:

Mr. Paul R. Steffenhagen, Dept. DF  
Executive & Professional Placement  
The National Cash Register Company  
Main & K Streets  
Dayton, Ohio 45409

AN EQUAL OPPORTUNITY EMPLOYER M/F

## Analysts Programmers

### \$8,000 – \$25,000

## Query our file!

How many nanoseconds would you need to contact 2000 employers and compare your achievements with their requirements.

Our on-line position evaluation system can save you  $N^2$  by comparing your qualifications and objectives with the opportunities available through our contacts with employers on an international basis and through our affiliations in 85 cities.

Send your resume including salary requirements and geographical preference to:

Ray Alcorn, President

## PerSyst

INC.

540 Granite St., Braintree, Mass. 02184  
1821 University Avenue, St. Paul, Minn. 55106  
9525 Georgia Avenue., Silver Spring, Md. 20910  
301/587-0303

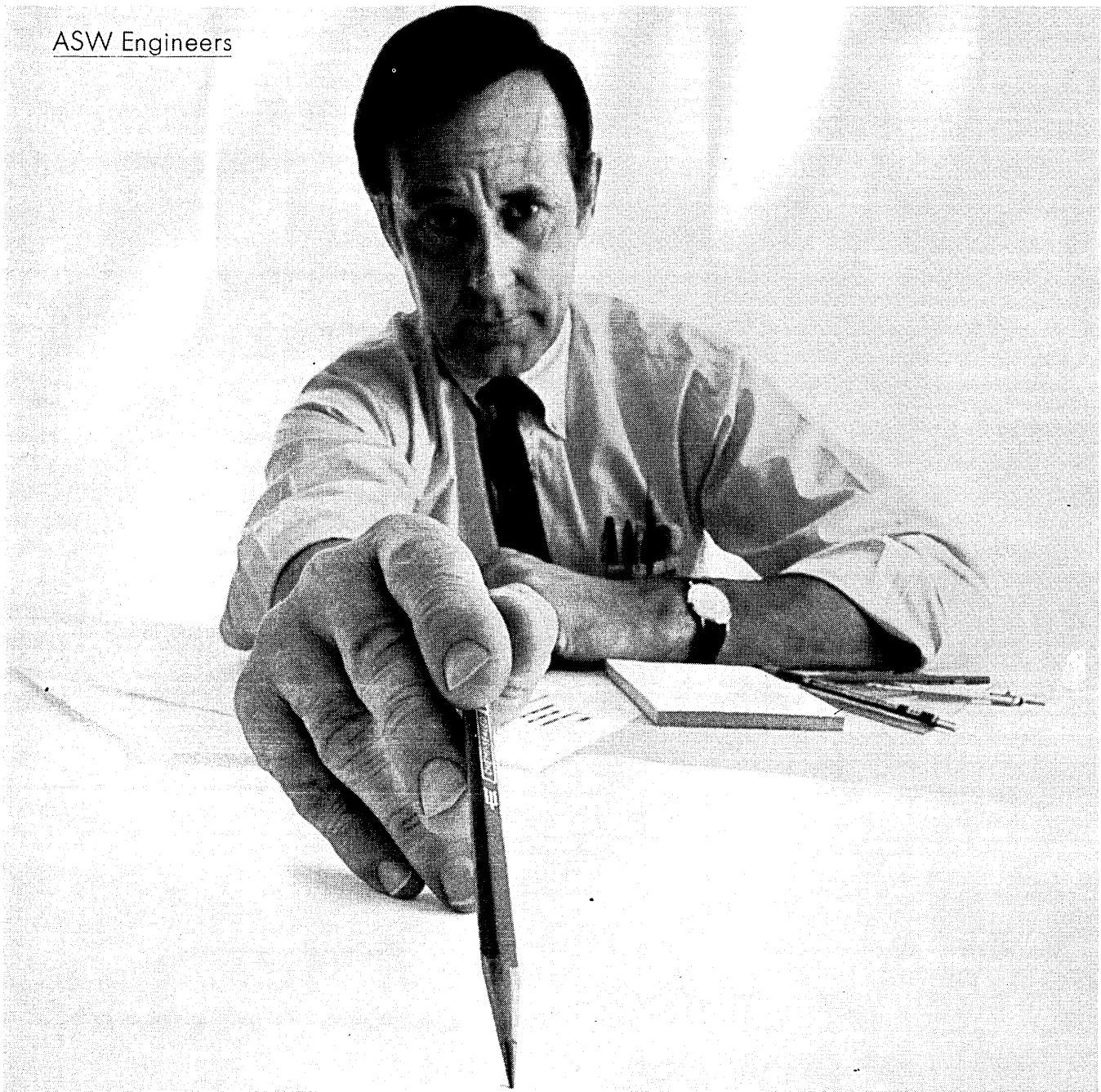

## We need men with pencils to hunt submarines.

We've expanded our hybrid computer organization and created two new software groups. And, right now, we need senior people on our prime contracts for total ASW systems software design and integration. These programs include the U.S. Navy's P-3C, new S-3A, and numbers of advanced R&D projects.

### **COMPUTER PROGRAMMERS**

*Hybrid:* To perform continuous system simulation and dynamic analysis, using hybrid techniques, in support of advanced engineering concepts.

*General-Purpose:* To develop software for tactical, system-test, and diagnostic real-time programs for advanced ASW systems.

*Simulation:* To develop software for tactical and mission programs for man-machine ASW simulators.

For more information or to submit your resume, write to C. R. Alexander, Employment Manager, Department 1402, 3409 Empire Avenue, Burbank, California 91503.

An equal opportunity employer.

**LOCKHEED-CALIFORNIA COMPANY**  
A DIVISION OF LOCKHEED AIRCRAFT CORPORATION

# advertisers' index...

Raytheon Computer ..... 230, 231  
 RCA Computer Systems Division ..... 272  
 RCA Information Systems Division ..... 254  
 RCA Magnetic Products ..... 213  
 Redcor Corporation ..... Cover 3  
 Remington Rand Office Systems Division ..... 133  
 Resources Objectives, Inc. .... 262, 271  
 RFL Industries, Inc. .... 143  
 Rixon Electronics, Incorporated ..... 127  
 RSVP Services ..... 271

Sanders Associates, Inc. .... 2, 3  
 Scan-Data Corporation ..... 120, 121  
 Scientific Time Sharing Corporation ..... 206  
 Sheridan Associates Inc. .... 252  
 Sikorsky Aircraft, Division of  
 United Aircraft Corporation ..... 266  
 Singer, Friden Division ..... 246  
 Source EDP ..... 259  
 Sperry Rand Corporation, Univac Division ..... 176  
 Spiras Systems, Inc. .... 128  
 Standard Computer ..... 56, 57  
 Sykes Datatronics, Inc. .... 33, 34, 35, 36  
 Systematics/Magne-Head Division,  
 General Instrument Corporation ..... 8  
 Systemation Consultants, Inc. .... 258

Systems Engineering Laboratories ..... 96, 97

Tab Products Company ..... 211, 223  
 Tally Corporation ..... 1  
 Talcott Computer Leasing, Division of  
 James Talcott, Inc. .... 32  
 Technitrend Corporation, Inc. .... 139  
 Tel-Tech Corporation ..... 209  
 Teletype Corporation ..... 10, 11  
 Texas Instruments Incorporated ..... 240  
 3M Company ..... 38, 39  
 Typagraph Corporation ..... 145

Uchida Yoko Co., Ltd. .... 228  
 Ultronic Systems Corp., Data Communications  
 Products Division ..... 45  
 United States Motors Corporation ..... 23  
 Univac Division, Sperry Rand Corporation ..... 176  
 University Computing Company,  
 Graphic Systems Division ..... 52, 53

Varian Data Machines, A Varian Subsidiary ..... Cover 2  
 Vermont Research Corporation ..... 196  
 Viatron Computer Systems Corporation ..... Cover 4

Wang Computer Products, Inc. .... 9  
 Western Telematic Inc. .... 54  
 Wilson Jones, A Division of Swingline Inc. .... 37  
 Wright Line, A Division of  
 Barry Wright Corporation ..... 186

**COMPUTER PROFESSIONALS:**  
**"HOWARD LEVIN IS PROBABLY**  
**THE WORLD'S BEST QUALIFIED\***  
**EDP EMPLOYMENT AGENT"**

\*MBA, Personnel management; 5 years industrial personnel experience for a major electronics and computer firm; 5 years hands-on computer programming and systems analysis experience; Director and placement counsellor for RSVP SERVICES since 1966.



His personal services are *free and convenient*. Why settle for less?

**SERVING**  
**PHILADELPHIA, NEW JERSEY, NEW YORK**  
 CALL COLLECT: N.J. (609) 667-4488 (24 HOUR LIVE  
 PHILA. (215) 922-3993 ANSWERING SERVICE)

or send resume or rough notes of objective, salary, education, and experience to:



HOWARD LEVIN, Director, Dept. M  
 RSVP SERVICES  
 ONE CHERRY HILL MALL (Suite 714)  
 CHERRY HILL, N.J., 08034

Recruitment, Selection, Vocational Training, Placement for Computer Oriented Companies

# COBOL & BAL PROGRAMMERS

## GREATER BOSTON AREA

We have several openings that require one or more years experience in COBOL and/or BAL (preferably System 360).

These positions offer excellent systems exposure and competitively attractive salary offers.

**SALARY RANGE: \$9,500 to \$16,500**

IF....you live in the Boston area  
 OR....you live east of the Mississippi  
 AND...you want to be where it is

**CALL....WRITE....WIRE**

**R. L. MANNING**  
 (617) 862-6200



1 Militia Drive  
 Lexington, Mass. 02173

CIRCLE 528 ON READER CARD

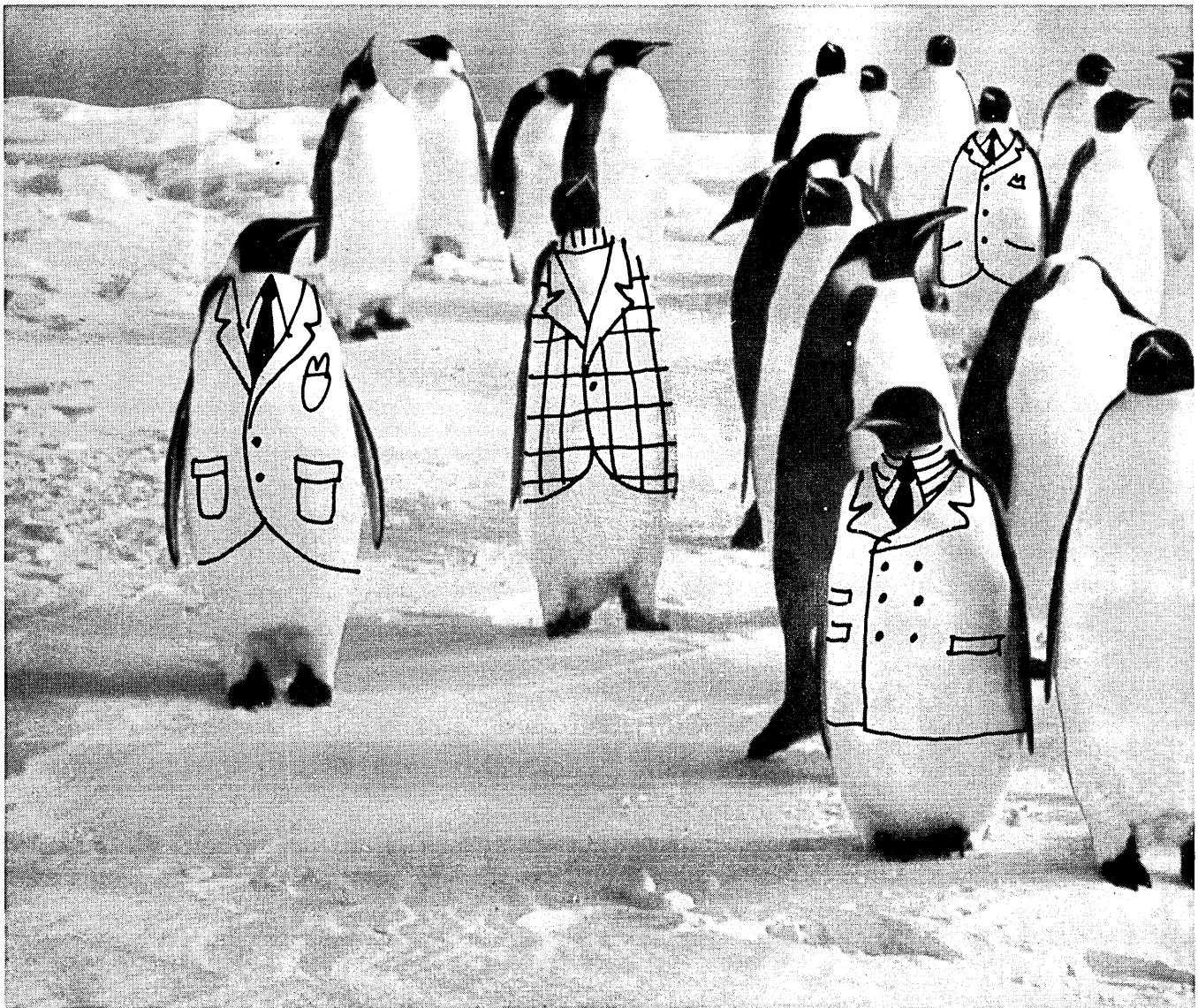

## Systems Programmers-Be yourself at RCA Marlboro

You can be casual or conservative as long as you're involved where it counts — writing the operating systems of the future.

At our modern new facility in Marlboro, Massachusetts the atmosphere for creative thinking is already established. Now we are forming the group that will develop the most forward-looking time-sharing/background-batch system yet envisioned.

Other groups are building on the TSOS system to provide new capabilities within the framework of announced hardware systems. In addition, we are looking for a totally new system.

If you are interested in being "involved" Marlboro is your kind of place. Specific openings include:

**System Analysts** — You should have experience in shaping the architecture of a product; considering the trade-offs; and in finding the basic structure that makes the hardware-software interface tractable.

**Operating System Implementors** — If you have already been through a major software product cycle and are now ready for the interesting parts. In addition, there are openings for people with experience in input output and data-management interfaces.

**System Analysts and Designers** — Openings for individuals who are interested in measuring, simulating, analyzing and testing the real performance of software-hardware combinations, plus contributing to architectural design.

Whatever your interest — programming or management — you should investigate the wide range of opportunities at RCA Marlboro.

Please send your resume to Mr. D. J. McPhee at RCA Computer Systems Division, Dept. D-1, 200 Forest Street, Marlboro, Mass. 01752. We are an equal opportunity employer.

**RCA**  
COMPUTERS

# the forum

*The Forum is offered for readers who want to express their opinion on any aspect of information processing. Your contributions are invited.*

## AN OBJECTION TO "I OBJECT"

I object, too! I object to Bob Patrick's blast, "I Object" (October, 1969). In fact, I object damn near paragraph by paragraph.

The military is said to be making decisions based on information gotten from "some of the most obsolete junk computer equipment in the world." Let's take SAC's automated command control system (SACCS). The system is obsolete, yes—the first IBM 7090 went into the control room in 1960. This was expanded to include AN/FSQ31, 7090, 1401, 1460 equipment; oddly enough all made by that "junk" manufacturer, IBM. This system is obsolete and SAC is replacing it. The only reason SAC hasn't replaced it earlier is money. Bob, there has been a slight squeeze on spending money in the government—Vietnam and taxes, you know.

The SAC system is typical of many government systems, both military and civilian. It reflects the state of the art in computers at the time it was developed. It's obsolete but is not junk, and it never was. Not so long ago, SDC gave a demonstration of a personnel information system at an American Management Association seminar in San Francisco; crt display units showed the results of the demonstration retrieval. The demo was on the AN/FSQ32 in Santa Monica, not the IBM 360/67 sitting next to it. The old Q32 was running and the 67 had software problems. That shows that the Q31 and Q32 may be obsolete but they run. They are not "junk."

I'll have to have a paragraph three like Bob did to show you that I'm an "expert." I was in the Air Force nine years (I spent more than one week end on that SAC IBM 7090), the Veterans Administration four years, NASA two years, the Civil Service Commission two years, and now I'm director of government programs for CTC Computer Corp. The job's not as big as the title, but

titles always help when you don't get the salary. Anyway, I've got over 17 years' government experience, and that experience says that Bob is wrong paragraph by paragraph.

Like that paragraph four, "It's amazing what you can find out from a sergeant at two o'clock . . ." Just about as amazing as what you can find out at two o'clock in the morning in any computer shop. The federal government doesn't have any monopoly on lack of programming standards, imperfect software, poorly trained personnel, or management ignorance. Back to that sergeant at two o'clock . . . if he were at SAC, the programs he was running were probably written by IBM FSD or SDC, anyway. The TRW programs are all efficient (I've got to say that, I'm a consultant). And about that "industrial atmosphere" for competition—man, you just haven't seen a spot-promotion bird colonel working as a wing commander under Curt LeMay!

"Some of us have for several years been trying to improve the personnel situation . . ."—very bashful that. Oddly, the military and the Civil Service Commission have been working on that little problem, too. The commission has upped the grade structure to include grades of GS-5 to GS-15 for computer people, and the last three pay raises have finally made federal civilian salaries competitive. The classification standards for operator, programmer, and analyst have been rewritten to make sense instead of nonsense and new classifications of computer specialist and computer support positions have been added so that a tape librarian is no longer called a file clerk. The military trains its programmers and operators much better than the typical business does. I notice that ex-servicemen don't seem to have much of an unemployment problem when they can show a computer MOS or AFSC. The

software firms are loaded with people who learned their trade in the military (like me). I run into old USAF buddies all over the computer community. The military training is certainly much better than "ye olde diploma mill" commercial programmer school ("give me \$1,000 and I'll make you a computer specialist"—spelling deliberate. I've even seen COBOL spelled wrong in some school advertisements).

In fact, Bob, I've taught over 500 federal systems analysts and programmers your array method of allocating resources to activities (RM-4232-PR, September, 1964) in Civil Service courses in systems analysis; and honest, they learned it. The government training people aren't perfect, but they do try. You ought to go down to San Diego and see the training at the Navy Fleet Computer Programming Center. I taught a systems course to the faculty and had to run like hell to keep ahead of them.

"For some reason, the bureaucrats in the federal hierarchy feel obligated to give every corporation an equal opportunity to bid . . ." God, man! What do you want them to do, sole source? How do you know if a bidder is unqualified unless you evaluate his bid? Now about that gerrymandering procurements so that IBM loses. In command and control systems? Have you been to SAC HQ and March AFB, Bob? It's wall to wall IBM gray, just like SDC in Santa Monica!

When writing specs in the government you have to fight like hell to keep the IBM reps off the pencil. I've seen more than one thick RFP with "byte" on every other page. That kind of crap doesn't make the guys at Univac and Control Data too happy. On every selection committee I've served on and every set of specs I've helped write, everybody has a devil of a time to keep from spelling computer with three letters; just like industry, where they look up the computer phone number under "I."

I remember not too long ago a man named Binger who had a job at Honeywell, got so mad over a procurement that he threatened to sue the Air Force—two many bytes in the RFP. The procurement was reopened and . . . let me see . . . yeah . . . IBM lost it and Burroughs got it—at substantial savings to the taxpayer. Anybody that thinks IBM has been shafted by federal procurement has got to be cracking up.

From 1964 to 1967 the federal government procured a lot of equipment



## the forum . . .

from Univac, Control Data, and Honeywell. The H200 was running and the 360 OS was being referred to by Jim Babcock as "big ooze." Remember Jim's 360/50 isn't exactly standard and the software isn't exactly OS. Or take the 360/67; in 1967 the Univac 1108 worked and 360/67 software didn't, so guess what? The government bought 1108's instead of 360's. I wonder why. AEC went to the Control Data 6000 series. What ever happened to the 360/95?

"If IBM and the other qualified manufacturers fail to receive contracts . . .

the federal government will be able to select equipment and services only from those who chose to compete. Over the years . . . the federal government will have installed cats and dogs from all the lesser manufacturers and be totally out of the mainstream of computing." Bob, are you saying that if you don't buy IBM you are out of the mainstream of computing? Are Burroughs, Univac, Control Data, Honeywell, etc. making cats and dogs? Is walking through the swamp of JCL into the "big ooze" the only happiness there is in computing?

Enough! I'm through. I can't answer all those paragraphs. Bob, why don't you start all over; and use facts this time. It's much nicer that way.

—BARNEY WATSON

## UNBUNDLING REVISITED

The shockwaves are still reverberating through the industry, following the announcement of IBM on June 23, 1969, of the separation of its prices on services hitherto covered by the rental fees.

Most of the articles that I have read about the separation of services and prices tried to evaluate the effect of the change of policy on the industry and on the individual installation for obvious and self-serving reasons. But until now I have not found too much evidence of discussion of the change on IBM itself, and in turn how it may affect the industry. In my opinion, without such effort at evaluation we are describing an iceberg by its visible part and ignoring the rest.

If there has been a lack of effort in speculation concerning the effects of the change on IBM, it has been for a good reason. The immediately affected, namely IBM, is not about to engage in open conjecture concerning the drastic changes that its own structure and modus operandi will have to undergo. Nevertheless, if IBM is loathe to do it, I think that the users had better do it, so as to be prepared to face adversity once again.

I use the word adversity because I believe that IBM's management once again, reacting to outside pressure, has made a decision that will have repercussions inside and outside of IBM that at this time are very difficult to gauge.

I am sure that many veterans of the System/360 introduction period will recall the scramble, following the announcement of the 360, to get their orders in first to be the happy recipients of a third-generation computer, representing a significant increase of computing power for reduced prices. What we failed to appreciate at that time was that the 360 was in no shape to be released, and that it was released only because of the competitive edge that IBM was determined to maintain. The ensuing problems fully justified the saying that the earliest Christians get the hungriest lions. The inadequately debugged hardware, repaired by inadequately trained mechanics, run on inadequately debugged or nonexistent operating systems, provided many an incentive to develop ulcers or retire to chicken farming.

The same forces seem to be at work again. Pressures applied by the Justice Department and competitors alike made IBM decide to act first and think about it later. The decision to convert most of its service functions, such as Systems Engineering and Data Processing Education, into profit centers will have a traumatic effect on its organizational structure and basic philosophy, which have been the main ingredients in the success that IBM has had in its endeavors.

Everybody agrees that IBM's success is due to its superior manpower in both

sales and systems support. Very few people seem to ask the obvious question: "Where is this superior manpower coming from?" The answer is that IBM hires swarms of college graduates every year, most of them in the top half of their class, and trains them either in systems or in sales. Once their initial schooling is finished, they are sent out to the field either paired off with a more experienced man, or alone, where they will start practicing what they learned in theory. So who provides IBM trainees with on-the-job training? The answer is: the user.

If we accept this as a fact then we can start wondering just how many installations are going to pay 20 to 30 dollars an hour for systems assistance that will be provided by a trainee fresh out of school? If I want to hazard a guess, I would say very few. Those that want to avail themselves of the systems help that IBM is going to offer will insist on top talent for top dollar. If this is so then two questions come to mind: (1) where is this top talent coming from? and (2) who is going to train the new swarms of college kids on whom IBM counts for sustenance?

The profit center concept will convert IBM's System Engineering Division into just another consultant or software firm to be asked for bids on a given job. But this concept is the direct opposite of what IBM has done until now. The software houses and consultants are incapable of training new people by the thousands because they cannot afford it. You either train, or you make profit. We can safely say that today's software houses and consultant firms are filled to the brim by former IBM people who have been trained by IBM. There is as yet no indication of how IBM intends to resolve the sharp conflict between the essentially nonprofit service function that was, and the profit center approach that will allow it to maintain a training effort which represents a tremendous drain on its resources. Can it be done?

The people who are making decisions at IBM may be wondering about the same thing. But just as in the case of the 360, IBM is counting on the superior manpower that it has, and its esprit de corps, to carry it off once again. Meanwhile, we, as users, can look forward to a year or so of erratic or non-existent service from the newly created profit centers, until IBM has had the time, through trial and error, to straighten out the mess that the unbundling created. —LASZLO KRISCH

# THINK REDCOR RENTAL



**The rentable \*MIDI's standard features include:**

- 860-nanosecond cycle time
- 8K 16-bit word memory—user expandable in 4K increments to 32K
- ASR 33
- High-speed multiply and divide
- Memory parity and memory protect
- Hardware fill switch
- Roll arrow feature
- Bi-directional index register
- Real-time clock

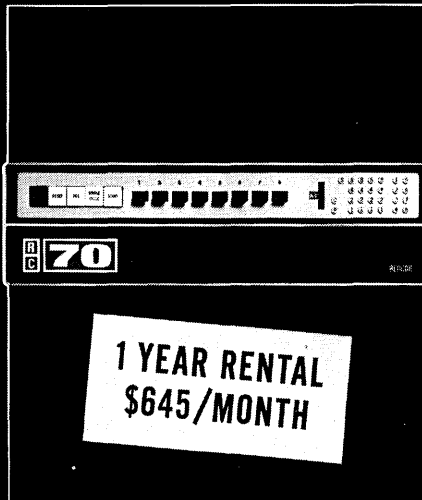

- Direct memory access
- Automatic power shut down and restart
- Operator maintenance panel
- Internal interrupt
- Complete line of peripherals and interfaces available
- Equipment rack
- FORTRAN IV Compiler and Assembler
- Immediate Delivery
- PURCHASE: \$21,500 (FOB REDCOR)
- 1 YEAR RENTAL \$645/MONTH

**\*MIDI COMPUTER:** Submicrosecond 16-bit computer compactly packaged with megacycle throughput word rate for OEM and system requirements. The MIDI classification includes the RC 70, 516, SIGMA 2, 2116B, 810B, 1700, and as DEC says the PDP 15.



Complete Systems Capability / 7800 Deering Avenue, P.O. Box 1031, Canoga Park, California 91304—(213) 348-5892

# He knows now!

With System 21 you can afford to know now instead of next month



067-4199 41  
MODEL 2121  
QTY 1000  
DESCRIPTION  
270 5  
MODEL SHELF#  
0024 20270  
QTY 8000 DATE

Inventories cost money. And, the longer goods stay in inventory the more they cost you. If it takes days for handwritten forms to get coded, punched and into your computer, inventory turnover is that much slower.

System 21 frees inventory — and cash — by letting your stock clerks record changes as they happen — in computer-usable form. It's quicker and easier to record data at a System 21 station than write it by hand. Less chance of error, too. So you get accurate, up-to-date reports. (And, if you want, a System 21 printing robot will even type out your inventory reports.) It's that simple.

VIATRON Computer Systems Corporation • Route 62 • Bedford, Mass. 01730 • Tel.: (617) 275-6100

CIRCLE 11 ON READER CARD