

Electronic Design 20

VOL. 18 NO.

FOR ENGINEERS AND ENGINEERING MANAGERS

SEPT. 27, 1970

RECEIVED
SEP 30 1970
CALIFORNIA

Generate functions accurately by storing coordinate data in a read-only memory. Smooth curves of two or three dimensions by time-averaging between data points. Digital or analog output, fast response, small size and excellent repeatability are among the reported advantages of this design technique. See page 42.

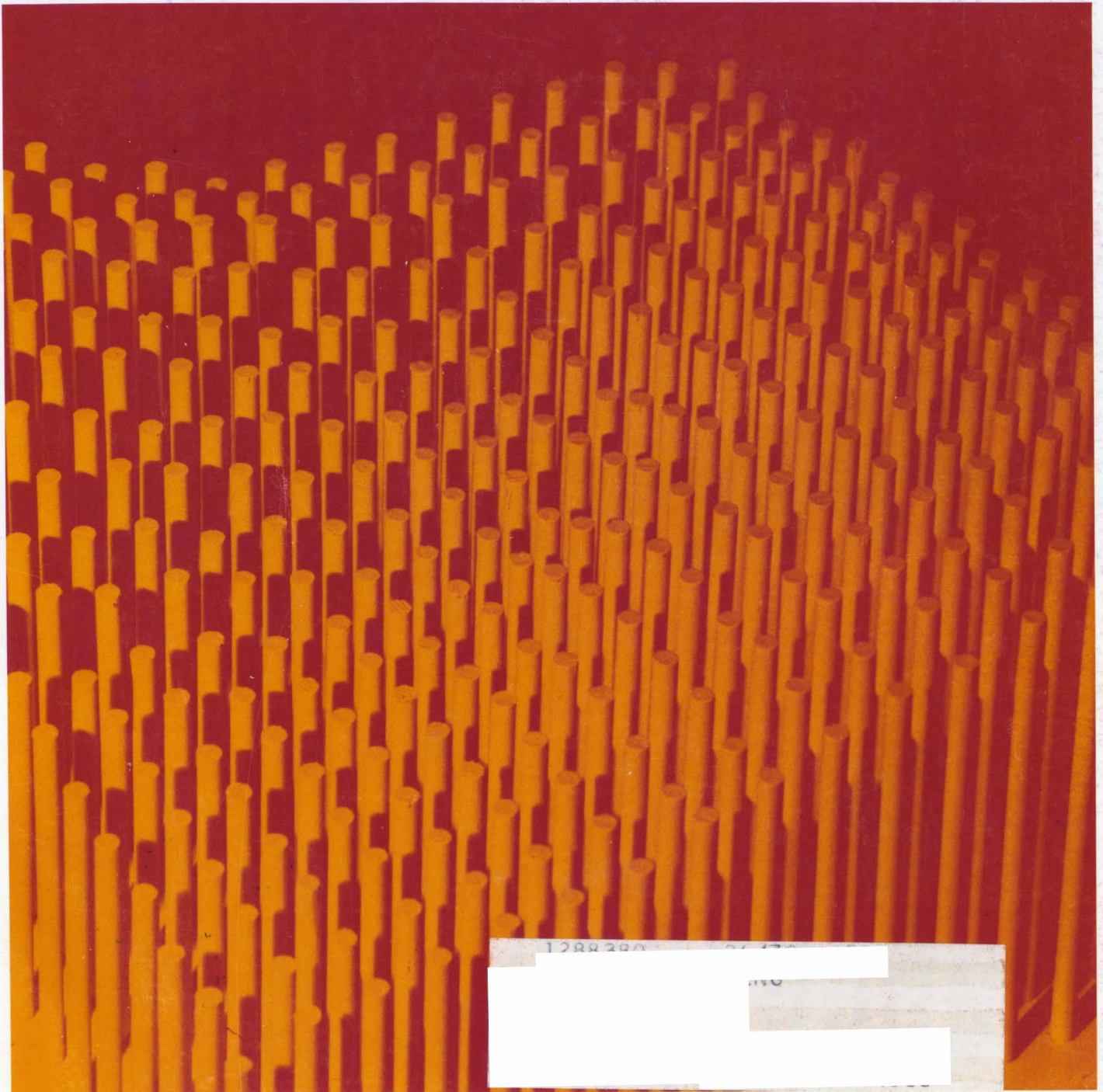

SAMPLING

REAL-TIME

STORAGE

ECONOMICAL

18 GHz
250 MHz
100 MHz
500 kHz

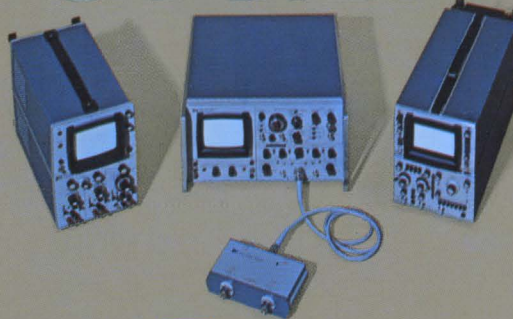

HEWLETT **hp** PACKARD

OSCILLOSCOPE SYSTEMS

What's new in HP Scopes? 18 GHz, dual-channel sampling! New, faster HP diodes now extend sampling capability through 18 GHz. For the first time, you can directly view and measure 18 GHz CW signals (or 20 psec risetime pulses).

But there are more new scope innovations from HP. There's the new, easy-to-use, 250 MHz real-time scope... and new, direct read-out TDR with $\frac{1}{4}$ " resolution... and new variable persistence and storage scopes for measurements up to 100 MHz... and a whole new series of low-cost 500 kHz scopes.

AND, *there are more eye-popping*

scope ideas just around the corner!

Next time you see your HP field engineer, ask him what's new in scopes. You'll be surprised by all that's happening to give you better, more economical scope measurements. One thing, we bet you'll get a new (and better) answer, every time you ask!

Are you thinking about a new scope? Are you wondering whether you should continue down the same old road? Or is it time you took a look

at another manufacturer? The HP road means going with the demonstrated leader — maker of performance champs.

Call your HP field engineer, right now, if 18 GHz sampling is your interest. Complete 18 GHz sampling system available with delayed sweep, or w/o delayed sweep. If you already have an HP 12.4GHz sampling system, add the new 18 GHz HP 1430B remote sampler. Write Hewlett-Packard, Palo Alto, California 94304. Europe: 1217 Meyrin-Geneva, Switzerland.

080/6



THE 0.1% PORTABLE IMPEDANCE BRIDGE

...in the GR tradition of better measurements

GR's new 1656 Impedance Bridge rounds out the General Radio family of impedance bridges. Now there's a choice of three to suit your exact needs for accuracy and economy. All three measure broad ranges of C, L, R, G, D, and Q, while each has its own distinctions. The new portable 1656 offers 0.1% accuracy for only \$700 (price in the U.S.), the 1650 features 1% accuracy in a portable package for \$545, and the 1608 is a bench-type instrument with 0.05% accuracy for \$1675. All three are self-contained 1-kHz instruments; external oscillators and detectors will extend their ac testing capability to a 20 Hz-to-20 kHz range.

The 1656, like the other two bridges, measures C up to 1100 μF , L up to 1100 H, and R to 1.1 M Ω . With the 1656, G can be measured up to 1.1 Ω ; D and Q cover over-all ranges of 0 to 50 and 0.02 to ∞ , respectively. The 1656 resolves C down to 0.1 pF, L to 0.1 μH , R to 0.1 m Ω , and G to 0.1 n Ω . Your best bet, anywhere, for dc measurements is the 1656: consider the 10- $\mu\text{V}/\text{mm}$ detector sensitivity and the wide resistance and conductance ranges.

Measurement of the new high-precision components demands an accurate bridge. With four-decade lever balancing, the 1656 achieves *true* 0.1% basic accuracy and a direct and easy readout of all four digits, without the need

for interpolation or vernier interpretation. A rack version of the 1656 is available for \$735; GR also makes an accessory \$45 test jig for connecting axial-lead components.

Know all the members of our impedance-bridge family by name:

1656—0.1% accuracy, portable, \$700.

1608—0.05% accuracy, bench, \$1675.

1650—1% accuracy, portable, \$545.

Whichever degree of measurement performance you require, you can get complete specifications from your nearest GR District Office or from 300 Baker Avenue, Concord, Massachusetts 01742. In Europe write to Postfach 124, CH 8034, Zurich, Switzerland.



General Radio

ATLANTA 404 633-6183 / BOSTON 617 646-0550 / CHICAGO 312 992-0800 / CLEVELAND 216 886-0150
DALLAS 214 637-2240 / LOS ANGELES 714 540-9830 / NEW YORK IN Y 212 964-2722 IN J 201 943-3140
PHILADELPHIA 215 646-8030 / SAN FRANCISCO 415 948-8233 / SEATTLE 206 747-9190 / SYRACUSE 315 454-9323
WASHINGTON, D.C. 301 881-5333 / TORONTO 416 252-3395 / ZURICH (051) 47 70 20

INFORMATION RETRIEVAL NUMBER 4

Why Singer-Friden uses Teradyne equipment to test ICs. And transistors. And diodes. And resistors. And capacitors.

At the Albuquerque plant of Singer's Friden Division, a battery of five instruments tests the million or so components Friden buys each month for use in its calculators and copiers. Because all five instruments were made by the same manufacturer, they can share accessories such as test fixtures and multiplexers. Because all five were made by Teradyne, they have no calibration adjustments whatsoever and carry 10-year warranties.

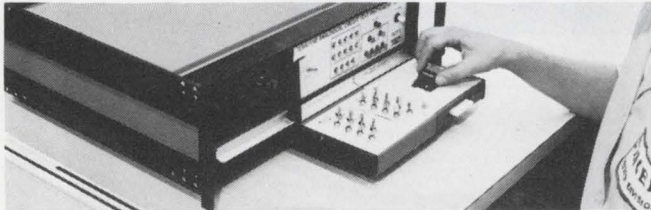

For digital ICs, Friden uses a J133 Analogical Circuit Test Instrument, card-programmed to run functional and parametric tests on about a dozen different devices.

Transistors are put through a series of 9 to 12 tests by a T217 Transistor Test Instrument.

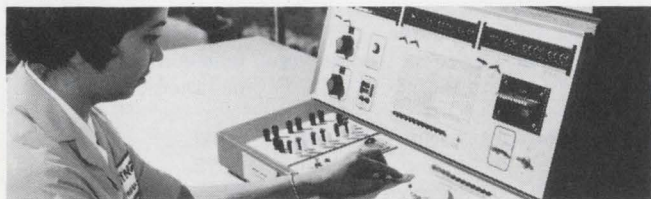

Zener diodes are tested on a Teradyne Z180, which quickly compares zener voltage and zener impedance against preset limits.

A C357/C270 capacitor inspection system compares capacitor values against two C limits and one D limit with ratio-arm accuracy and automatic-

bridge speed.

An R163 tests resistors against a pair of plus tolerance limits and a pair of minus tolerance limits, all independently programmed.

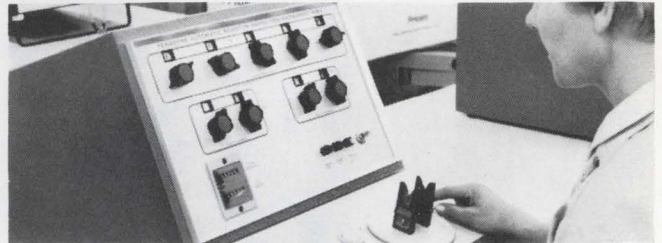

Friden uses all five instruments for analytical as well as inspection purposes. "In fact," says QA Manager Charles Maxwell, "we've picked up some transistor faults on our T217 that our curve tracer couldn't see." Maxwell notes another advantage of the all-Teradyne approach: "My component vendors seem to accept test results without question when they find out we use Teradyne gear."



Equipping an incoming-inspection department used to mean buying an assortment of laboratory instruments and hoping that they would stand up under constant use. Now, a single call to Teradyne can save you all that shopping time and give you the kind of test equipment that was born to be worked hard. Teradyne, 183 Essex Street, Boston, Massachusetts 02111.

Teradyne makes sense.

INFORMATION RETRIEVAL NUMBER 5

NEWS

- 23 **News Scope**
- 27 **Design the accidents out of your product!**
Good record-keeping and failure analysis are advised to curb increasing damage suits by consumers
- 30 **Bell's goal: A telephone revolution in 1970s**
Harried by traffic overloads, the utility is looking to new technology to increase capacity fourfold
- 31 **A laser that may change communications**
- 32 **Foreigners seek U. S. market despite recession**
- 32 **Sonar research put to work in urban sewage system**
- 36 **Technology Abroad**
- 37 **Washington Report**

TECHNOLOGY

- 42 **Generate functions from discrete data.** A special report on low-cost, high-accuracy read-only memories and averaging interpolation techniques.
- 50 **Laser diodes need high-current drivers.** Here's how to use avalanche transistors and SCRs to get big current pulses at high repetition rates.
- 54 **Can a production job be creative?** This director of manufacturing thrives on his work and tells why he finds it a challenge.
- 57 **Product Source Directory: P-C Board Connectors**
- 65 **Ideas for Design**

PRODUCTS

- 72 **ICs & Semiconductors:** Analog gate includes a driver at a cost of only \$6.
- 73 **Data Processing:** Long-term event recorder operates for 35 days.
- 76 **Instrumentation:** CRT displays data in full color.
- 74 **Components** 77 **Tools & Engineering Aids**
- 75 **Modules & Subassemblies** 77 **Packaging & Materials**
- 76 **Microwaves & Lasers** 90 **Product Index**

Departments

- 41 **Editorial:** Let's tighten up those sloppy buying practices
- 13 **Designer's Calendar** 80 **Application Notes**
- 39 **Sidelights** 82 **New Literature**
- 78 **Evaluation Samples** 85 **Bulletin Board**
- 79 **Design Aids** 88 **Advertisers' Index**

Information Retrieval Service Card inside back cover

Cover: Designed by Art Director Clifford M. Gardiner and Jack Weissman

Tektronix *PLUG-IN*

measurement flexibility

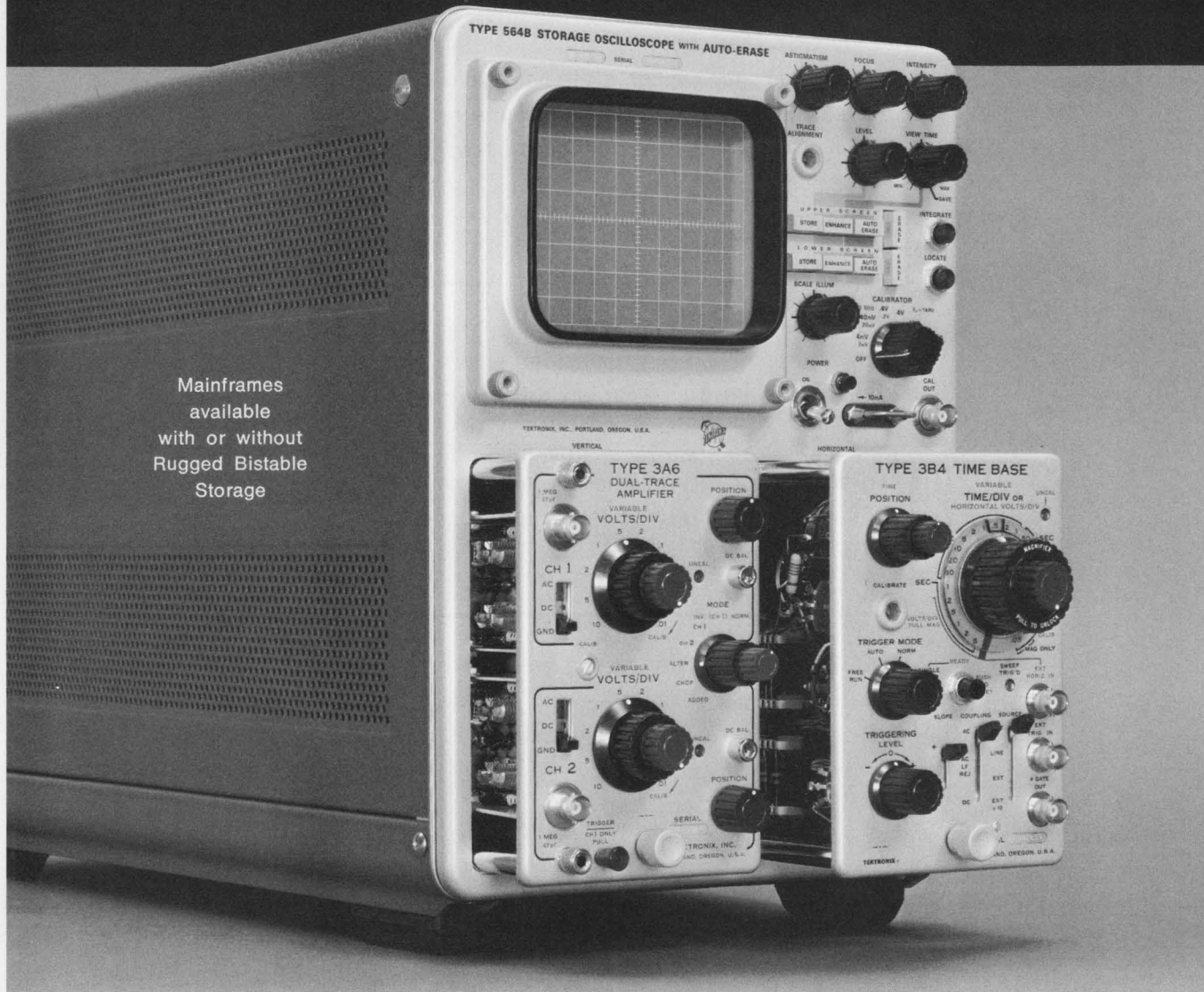

Mainframes
available
with or without
Rugged Bistable
Storage

The Dual Plug-In Feature of the 560-Series Oscilloscopes allows conventional Y-T or X-Y displays with either single-trace or multi-trace units. The 564B MOD 121N (pictured above) provides stored displays at constant brightness independent of signal repetition rates. Seven-inch rackmounts are available in this family of valued performers.

561B **\$595** **564B MOD 121N** ... **\$1,250**

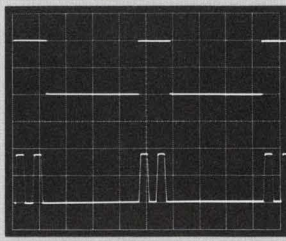

MULTI-TRACE

Compare time related pulse trains using this DC to 10 MHz, 35-ns risetime plug-in with deflection factors from 10 mV/div to 10 V/div.

Type 3A6 \$550

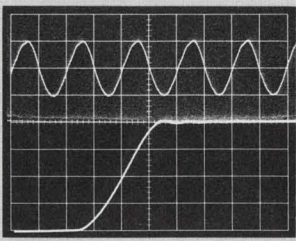
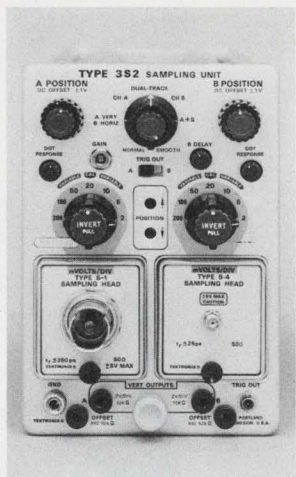

SAMPLING

Extend your measurement capabilities to 14 GHz with 25-ps risetime, internal triggering, dual-trace and interchangeable heads.

Type 3S2 \$950

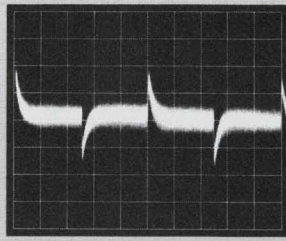
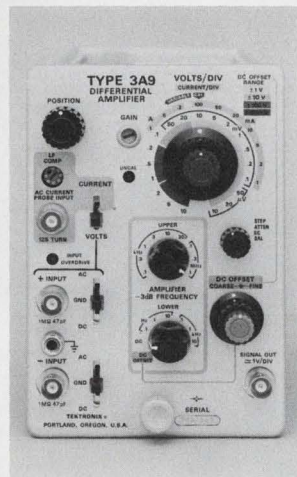

DIFFERENTIAL

Make differential measurements from DC to 1 MHz with 10- μ V/div deflection factor and 100,000:1 common-mode rejection ratio.

Type 3A9 \$525

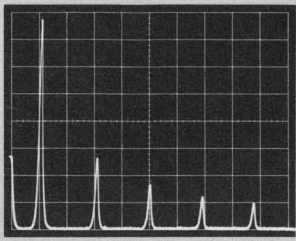
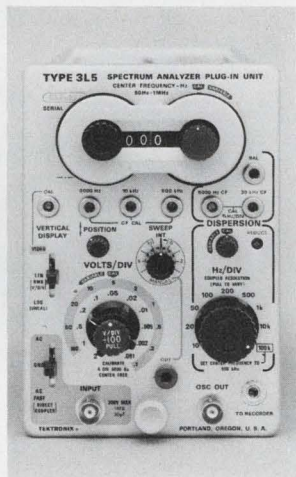

SPECTRUM ANALYSIS

Analyze the frequency spectrum from 50 Hz to 1 MHz with calibrated dispersion and calibrated deflection factors.

Type 3L5 \$1125

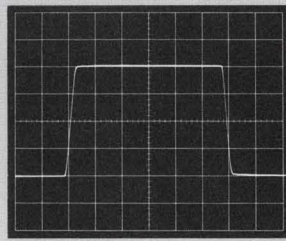

SINGLE-TRACE

Perform single-trace measurements from DC to 1 MHz at deflection factors from 50 mV to 50 V/div with this low-cost plug-in.

Type 2A60 \$140

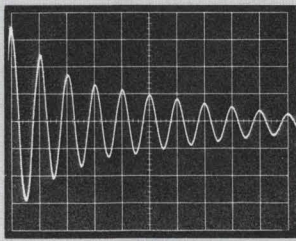
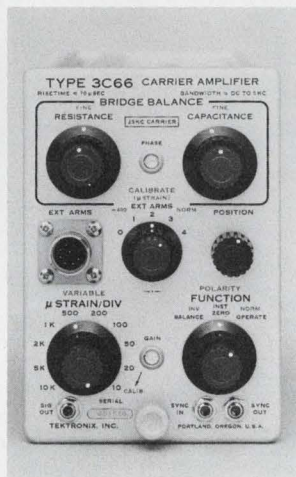

CARRIER AMPLIFIER

Measure force, acceleration, strain and displacement in applications such as stress analysis, vibration studies and fatigue tests.

Type 3C66 \$495

The Tektronix 560-Series Oscilloscopes have a complete selection of plug-ins, permitting you to adapt your measurement capabilities to meet your changing measurement needs. More than 25 plug-in units are available covering single channel, multi-trace, differential, sampling, spectrum analysis and other special purpose applications. Adapting your measurement capability to meet your changing measurement needs is assured.

For detailed specifications contact your local Tektronix Field Engineer or write: Tektronix, Inc., P.O. Box 500, Beaverton, Oregon 97005.

These instruments are available through our new Leasing Plan.
U.S. Sales Prices FOB Beaverton, Oregon

Tektronix, Inc.
committed to progress in waveform measurement

Fight noise pollution

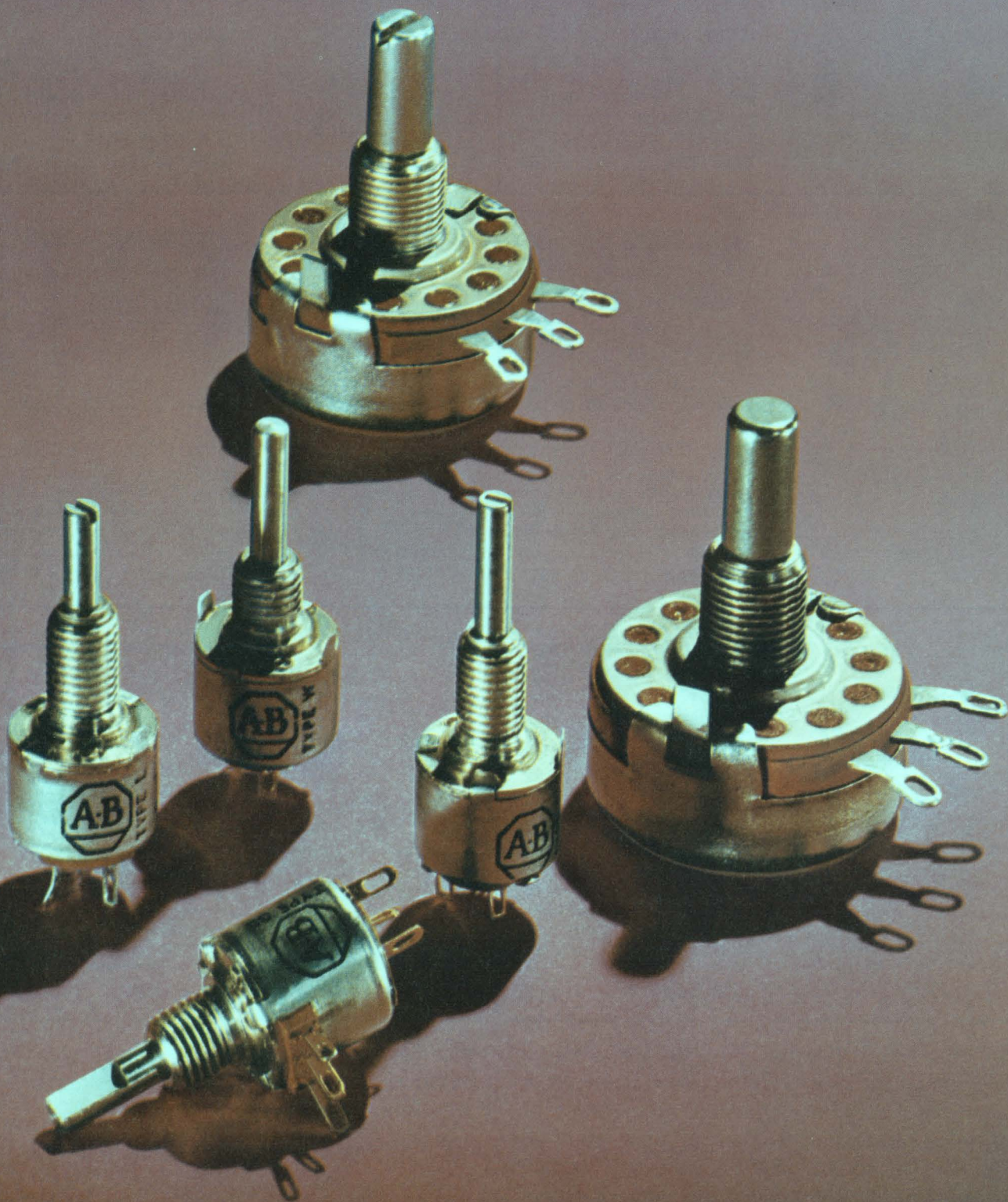

with this quiet family.

Hot Molding with Allen-Bradley's exclusive technique, gives these composition variable resistors an unusually low noise level. And importantly, this low noise level actually decreases in use. Under tremendous heat and pressure the resistance track is molded into place. A solid element with a large cross-section is produced.

This important Allen-Bradley difference means better short-time overload capacity and a long operating life. Control is smooth, resolution almost infinite. These variable resistors are ideal for high frequency circuits. Why should you trust the performance of

your designs or your reputation to anything less than Allen-Bradley quality? Use the most thoroughly "field tested" (over 20 years) variable resistors available today. Quantity stocks of popular types J, G, W and GD available for immediate delivery from your appointed A-B industrial electronics distributor.

For information write: Marketing Department, Electronics Division, Allen-Bradley Co., 1201 South Second Street, Milwaukee, Wisconsin 53204. Export office: 1293 Broad Street, Bloomfield, N. J. 07003, U.S.A. In Canada: Allen-Bradley, Canada Ltd., 135 Dundas Street, Galt, Ontario.

SPECIFICATIONS

	TYPE J— STYLE RV4	TYPE K	TYPE G— STYLE RV6	TYPE L	TYPE W	TYPE GD
CASE DIMENSIONS	5/8" deep x 1-5/32" dia. (single section)	5/8" deep x 1-5/32" dia. (single section)	15/32" deep x 1/2" dia.	15/32" deep x 1/2" dia.	15/32" deep x 1/2" dia.	35/64" deep x 1/2" dia.
POWER at + 70°C	2.25 W	3 W	0.5 W	0.8 W	0.5 W	0.5 W
TEMPERATURE RANGE	-55°C to +120°C	-55°C to +150°C	-55°C to +120°C	-55°C to +150°C	-55°C to +120°C	-55°C to +120°C
RESISTANCE RANGE (Tolerances: ±10 and 20%)	50 ohms to 5.0 megs	50 ohms to 5.0 megs	100 ohms to 5.0 megs	100 ohms to 5.0 megs	100 ohms to 5.0 megs	100 ohms to 5.0 megs
TAPERS Linear (U), Modified Linear (S), Clockwise Modified Log (A), Counter-Clockwise Modified Log (B), Clockwise Exact Log (DB). (Special tapers available from factory)						
FEATURES (Many electrical and mechanical options available from factory)	Single, dual, and triple versions available. Long rotational life. Ideal for attenuator applications. Snap switches can be attached to single and dual.	Single, dual, and triple versions available. Long rotational life.	Miniature size. Immersion-proof. SPST switch can be attached.	Miniature size. Immersion-proof.	Commercial version of type G. Immersion-proof.	DUAL section version of type G. Ideal for attenuator applications. Immersion-proof.

ALLEN-BRADLEY

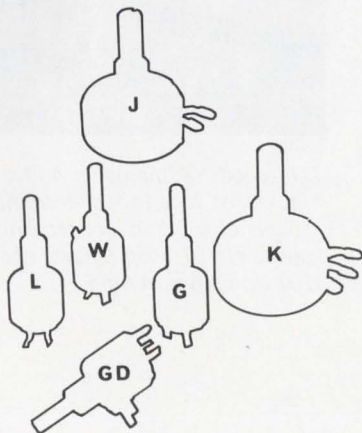

INFORMATION RETRIEVAL NUMBER 7

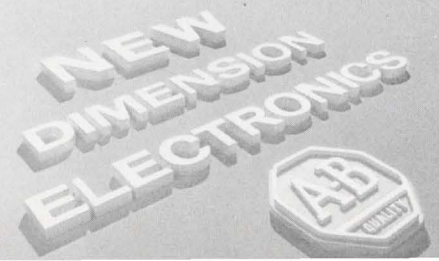



What happened to the model 19?

You're looking at some of the Teletype® basics used in building a data communications system. Printer, keyboard, tape sending and receiving combinations in a variety of speed capabilities. Teletype's modular design concept gives you the opportunity to extract the best terminal combination for system

needs today, and refine, add to, subtract and adapt as system modifications are called for. Just as important as the basics, are some of the things not obvious in the photos below. The logic devices, options and accessories that add almost limitless possibilities for making things happen exactly as

your system requires. We have some solid state logic devices that provide precise control of data traffic. That enable your computer to automatically poll data from a number of terminals and feed each terminal with processed data. There are error detection, correction and signal regeneration options to

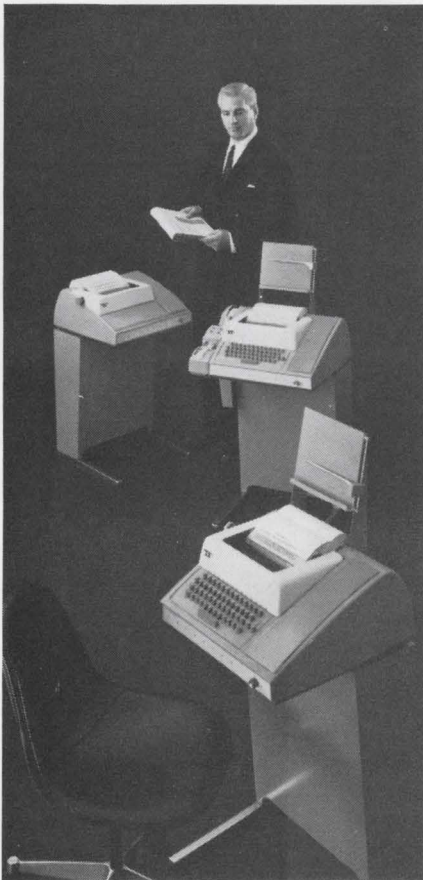

model 33 series: An extremely economical 100 wpm terminal line. Has 4-row keyboard, uses 8-level ASCII code. The most widely used terminal in time-sharing systems today.



model 35 series: A rugged, heavy-duty line of 100 wpm terminals. Uses ASCII. Units in foreground are self-contained paper tape punch and paper tape reader.



Telespeed™ equipment: A line of high-speed tape-to-tape terminals capable of sending and receiving at speeds of 750, 1050 (shown above), or 1200 words per minute.

DATA COMMUNICATIONS

equipment for on-line, real-time processing

keep data flowing faultlessly. Options such as pin-feed platens and form feed controls that make it possible to fill multiple copy business forms on-line. And many, many more. What did happen to the model 19? Believe it or not, there are still some of these old, die-hard terminals around. And that's

another advantage your data communications dollar buys when you specify Teletype equipment. It lasts. Moves data reliably, economically, for a long time. On a price/performance basis, Teletype equipment is in a class by itself.

Teletype data communications equipment is available in send-receive capabilities of up to 2400 words per minute. If you would like specific information about any of the equipment described here, write: Teletype Corporation, Dept. 89-17, 5555 Touhy Ave., Skokie, Ill. 60076.



model 37 series: One of the most versatile heavy-duty terminal lines going. Generates all 128 characters of ASCII. Operates at 150 wpm. Prints in upper and lower case.

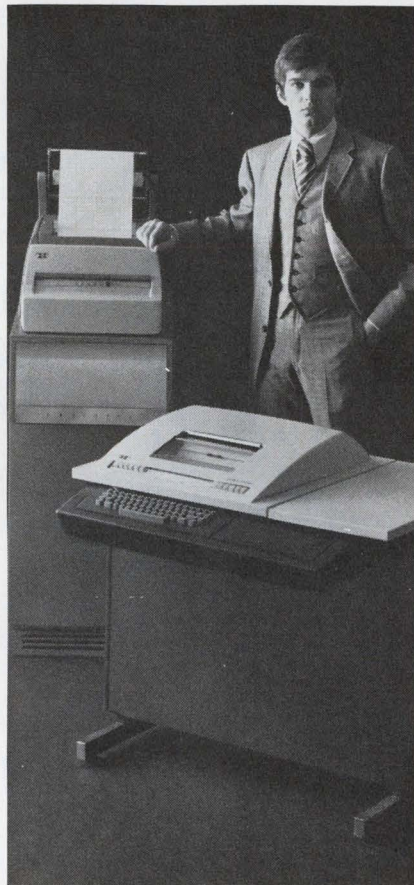

Inktronic® data terminals: A unique electronic, solid state terminal. Prints up to 1200 wpm. Forms characters through electrostatic deflection (no typebox). ASCII compatible.

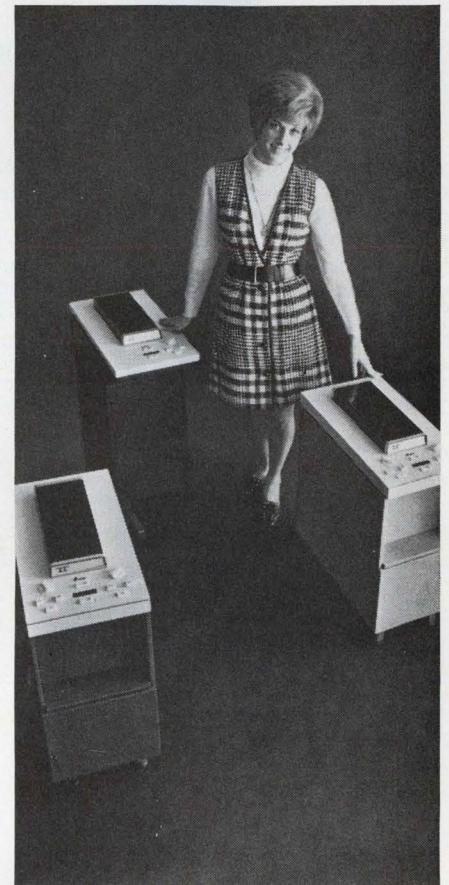

magnetic tape data terminals: Use compact reusable tape cartridges. Operate on-line at up to 2400 wpm, and connect "locally" to lower speed Teletype terminals using ASCII code.

Teletype is a trademark registered in the U.S. Pat. Office

machines that make data move



INFORMATION RETRIEVAL NUMBER 8

ELECTRONIC DESIGN 20, September 27, 1970

9

A significant advance in silicon rectifier power handling capacity

3 new series of silicon rectifiers from Tung-Sol permit designers to meet extremely high power requirements.

- Reverse voltage ratings to 5000 Volts
- Average forward current to 500 Amperes
- Surge overload ratings up to 8500 Amperes

Controlled avalanche characteristics provide transient handling capability that results in increased reliability.

All units feature ceramic-to-metal seals, mount in any position and are supplied in either polarity.

1511 SERIES

Max. av. forward current at 120° C—420 Amperes

Surge overload rating, 1 cycle—6000 Amperes

Controlled Avalanche Voltage—1250-3500 Volts

1621 SERIES

Max. av. forward current at 135° C—500 Amperes

Surge overload rating, 1 cycle—8500 Amperes

Controlled Avalanche Voltage—1100-2300 Volts

1611 SERIES

Max. av. forward current at 135° C—470 Amperes

Surge overload rating, 1 cycle—5200 Amperes

Controlled Avalanche Voltage—2600-5000 Volts



Write for technical data bulletins—
Tung-Sol Division, Wagner Electric Corporation
630 West Mt. Pleasant Ave., Livingston, N.J. 07039
Twx: 710-994-4865 • Phone: (201) 992-1100; (212) 732-5426

TUNG-SOL High Power Silicon Rectifiers

Trademark TUNG-SOL Reg. U. S. Pat. Off. and Marcas Registradas

INFORMATION RETRIEVAL NUMBER 9

INFORMATION RETRIEVAL NUMBER 10 ►



A new low in power supply design.

Acopian's new low profile power supply offers outstanding performance. Line and load regulation is .005% or 1 mv. Ripple is 250 microvolts. Prolonged short circuits or overloads won't damage it. And built-in over-voltage protection is available as an option.

Yet, it's the thinnest, flattest, most "placeable" 4.0 amp series regulated power supply ever offered . . . just 1.68" low. This low profile makes it perfect for mounting on a 1 $\frac{3}{4}$ " high panel, or vertically in a narrow space. Acopian's new flat package gives you design flexibility never before

possible. And a surprisingly low price gives you extra budget flexibility as well.

Standard models include both wide and narrow voltage ranges. Outputs from 0 to 48 volts. Current

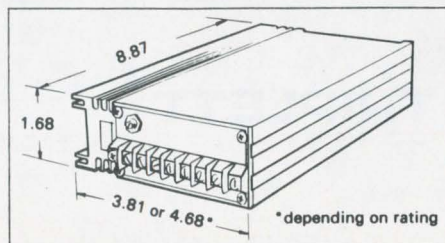

ratings from 1 to 4 amp. Prices from \$80.00.

For the full low-down on the new low-down power supply, write or call Acopian Corp., Easton, Pa. 18042. Telephone: 215-258-5441. And remember, Acopian offers 82,000 other power supplies, each shipped with this tag . . .



3 That are ready

For Top Quality Testing Performance

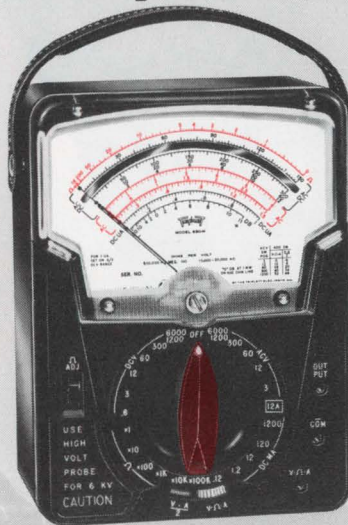

I Triplet's Model 630-M Type 1 V-O-M

- 1,000,000 Ohms per volt DC for greater accuracy on high resistance circuits. 20,000 ohms per volt AC.
- 1 μ a Suspension Meter Movement. No pivots, bearings, or rolling friction. Extremely rugged. Greater sensitivity and repeatability.
- 61 ranges, usable with frequencies through 100 kHz. Temperature compensated. 1 $\frac{1}{2}$ % DC accuracy, 3% AC in horizontal position.

\$23100

II Triplet's Model 630-NS V-O-M

- 200,000 Ohms per volt DC sensitivity for greater accuracy on high resistance circuits. 20,000 ohms per volt AC.
- Suspension Meter Movement. No pivots, no bearings, no hairsprings; no rolling friction. Extremely rugged.
- 62 ranges. Temperature and frequency compensated $\pm 1\frac{1}{2}$ % DC Accuracy, ± 3 % AC.

\$11600

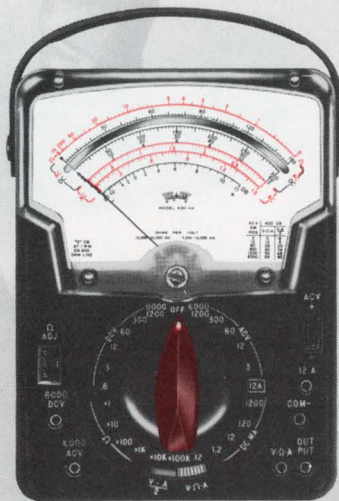

III Triplet's Model 630-NA Type 3 V-O-M

- One selector switch minimizes chance of incorrect settings and burnouts.
- 70 ranges: 1 $\frac{1}{2}$ % DC accuracy on meter; with mirrored scale and diode overload protection.
- Temperature and frequency compensation; polarity reversing.

\$9800

from the Instrument Makers... Established 1904



TRIPLETT
CORPORATION BLUFFTON, OHIO 45817

Designer's Calendar

OCTOBER 1970

S	M	T	W	T	F	S
				1	2	3
4	5	6	7	8	9	10
11	12	13	14	15	16	17
18	19	20	21	22	23	24
25	26	27	28	29	30	31

For further information on meetings, use Information Retrieval Card.

Oct. 26-28

Electronic & Aerospace Systems Convention (EASCON), (Washington, D. C.) Sponsor: IEEE. Richard Marsten, NASA Hdqs., Code SC, Washington, D. C. 20546.

CIRCLE NO. 401

Oct. 28-30

International Electron Devices Meeting (Washington, D. C.) Sponsor: IEEE. E. O. Johnson, RCA, 415 S. 5th St., Harrison, N. J. 07029.

CIRCLE NO. 402

NOVEMBER 1970

S	M	T	W	T	F	S
1	2	3	4	5	6	7
8	9	10	11	12	13	14
15	16	17	18	19	20	21
22	23	24	25	26	27	28
29	30					

Nov. 15-19

Engineering in Medicine & Biology (Washington, D. C.). Sponsor: IEEE. Richard Johns, 522 Traylor Bldg., Johns Hopkins School of Medicine, Baltimore, Md. 21205.

CIRCLE NO. 403

Nov. 17-19

Fall Joint Computer Conference (Houston, Texas). Sponsor: IEEE. L. E. Axsom, IBM Scientific Center, 6900 Fannin, Houston, Texas 77025.

CIRCLE NO. 404

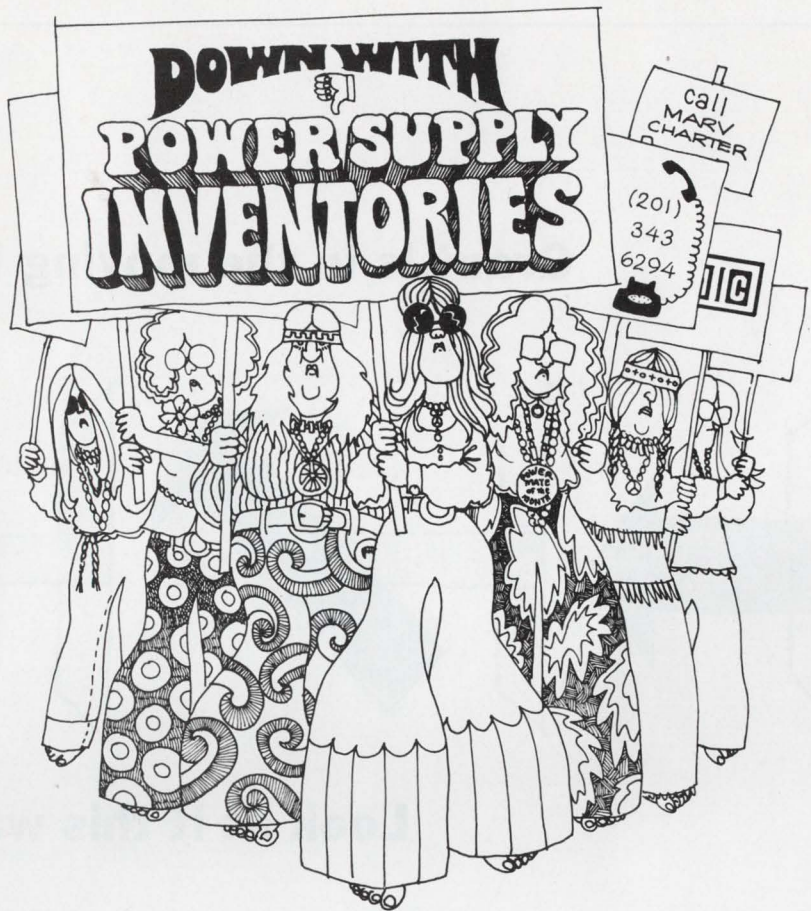

The UniPower series of compact, wide voltage range, regulated power supplies will reduce your power supply inventory drastically. A unique design concept, developed by Power/Mate Corp., allows any UniPower supply to be set for a range of voltages. Therefore, you need only inventory one supply in place of dozens. The entire UniPower Series replaces literally thousands of narrow-range supplies! Find out more about how to cut down your power supply inventory. Write or call POWER/MATE CORP. today.



Uni-30C
Price: \$134.00

The UniPower Series of Nine

- Uni-76 — 0-34 volts, 0.5 amps — \$76.00
- Uni-88 — 0-34 volts, 1.5 amps — \$99.00
- Uni-30C — 0-30 volts, up to 4 amps — \$134.00
- Uni-30D — 0-30 volts, up to 6 amps — \$151.00
- Uni-30E — 0-30 volts, up to 12 amps — \$174.00
- Uni-30F — 0-30 volts, up to 15 amps — \$205.00
- Uni-30G — 0-30 volts, up to 24 amps — \$265.00
- Uni-30H — 0-30 volts, up to 34 amps — \$315.00
- UniTwin-164 — dual output 0-25 volts, 0.75 amps — \$164.00

OUTPUT VOLTAGE vs. OUTPUT CURRENT FOR VARI-RATED UNI SERIES

MODEL	VOLTAGE															
	0-3	5	6	8	10	12	14	15	16	18	20	22	24	26	28	30
UNI-76	0.5 amp throughout range															
UNI-88	1.5 amps throughout range															
UNI-30C	4	4	4	4	4	3.75	3.6	3.5	3.4	3.25	3.0	2.9	2.75	2.5	2.5	2.1
UNI-30D	6	6	6	5.6	5.2	5.0	4.7	4.5	4.3	4.2	4.1	3.7	3.5	3.4	3.3	3.1
UNI-30E	12	12	11	10.5	9.5	9.3	8.5	8.0	7.7	7.5	7.0	6.5	6.0	5.7	5.5	5.2
UNI-30F	15	15	15	14.2	12.8	12.0	11.5	11.0	10.0	9.9	9.4	8.9	8.7	8.5	8.0	7.6
UNI-30G	24	22	21	20	18	17	16.5	16.0	15.5	15	14	13.5	13	12.5	12	11.5
UNI-30H	34	32	31	29	25	23	22	21	20	19	17	16.5	16	15.5	15	14.3

SPECIFICATIONS: Regulation — up to $\pm 0.005\%$ or 1 MV for line and load; Ripple — Less than 250 microvolts; Response Time — Less than 20 microseconds; Overload and Short Circuit Protection — Solid state. Instantaneous recovery, and automatic reset. Cannot be damaged by prolonged short circuit or overload. Internal or External Adjustable OVP Available.

FREE: Send for complete catalog. Write to:



POWER/MATE CORPORATION

514 SOUTH RIVER ST., HACKENSACK, NEW JERSEY 07601
PHONE: (201) 343-6294 TWX: (710) 990-5023

INFORMATION RETRIEVAL NUMBER 12

Grant is in the moving business

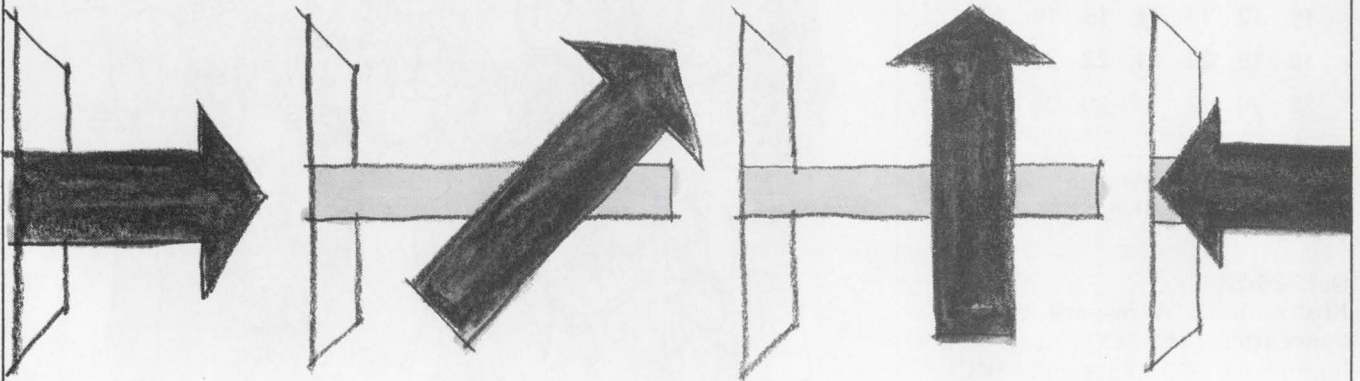

Look at it this way

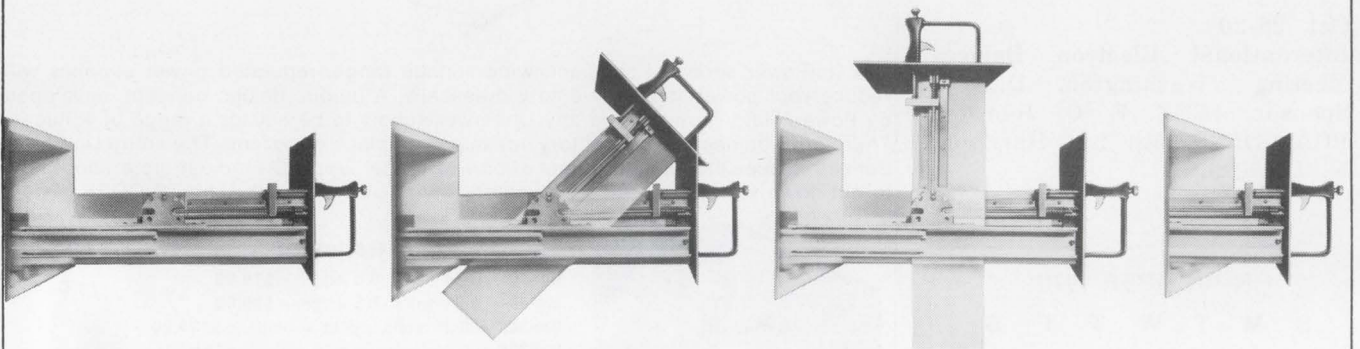

Have we moved you lately?

We move more things than you can imagine (more than we ever imagined when we first got into this business—years and years ago). We call our movers slides.

Some of our slides are steel-nerved and will precisely move delicate X-Ray equipment millimeters of an inch at a time. Some of our more muscular types carry submarine bunks from one position to another. Others take weighty electronic equipment for a short, sweet ride. Yet other slides handle metal drawers (and their contents) with kid gloves. Still others give dollar-bill changing vending machines a run for the money.

There are hundreds of Grant Slides for tens of thousands of applications. They increase reliability and save time, money and effort in the maintenance and repair of movable components.

Is your product moving in the right direction? Why not check it out. A Grant catalog is yours for the asking.

GRANT®
WE KEEP THINGS MOVING

GRANT PULLEY & HARDWARE CO., div. of Instrument Systems Corp., 21 High Street, West Nyack, N.Y. 10994 / Los Angeles, Calif.

SIGNAL SOURCERY



EXACT
electronics, inc.

P. O. Box 160
Hillsboro, Oregon 97123
Phone (503) 648-6661

Here's the line that's rapidly replacing oscillators, signal generators and old-fashioned waveform generators wherever engineers are looking for *sources with performance at the right price*. Just for a sampling, here's what's new at EXACT:

NEW Models 201 and 202 Waveform Synthesizers. Build most any digital or analog waveform, bit by bit—40 bits to work with.

NEW Model 124 Multigenerator. You name it—it does it.

NEW Model 127 Digital-Dial/Sweep Generator. Production line problems? Here's your signal source answer.

NEW Models 605 and 606 Programable Waveform Generators. Want to interface with a computer?

Plus a full line of signal sources starting as low as \$295, at frequencies from 0.0001 Hz into the high frequency band. Sweepers, trigger and gating, tone burst—pick the model that fits your needs.

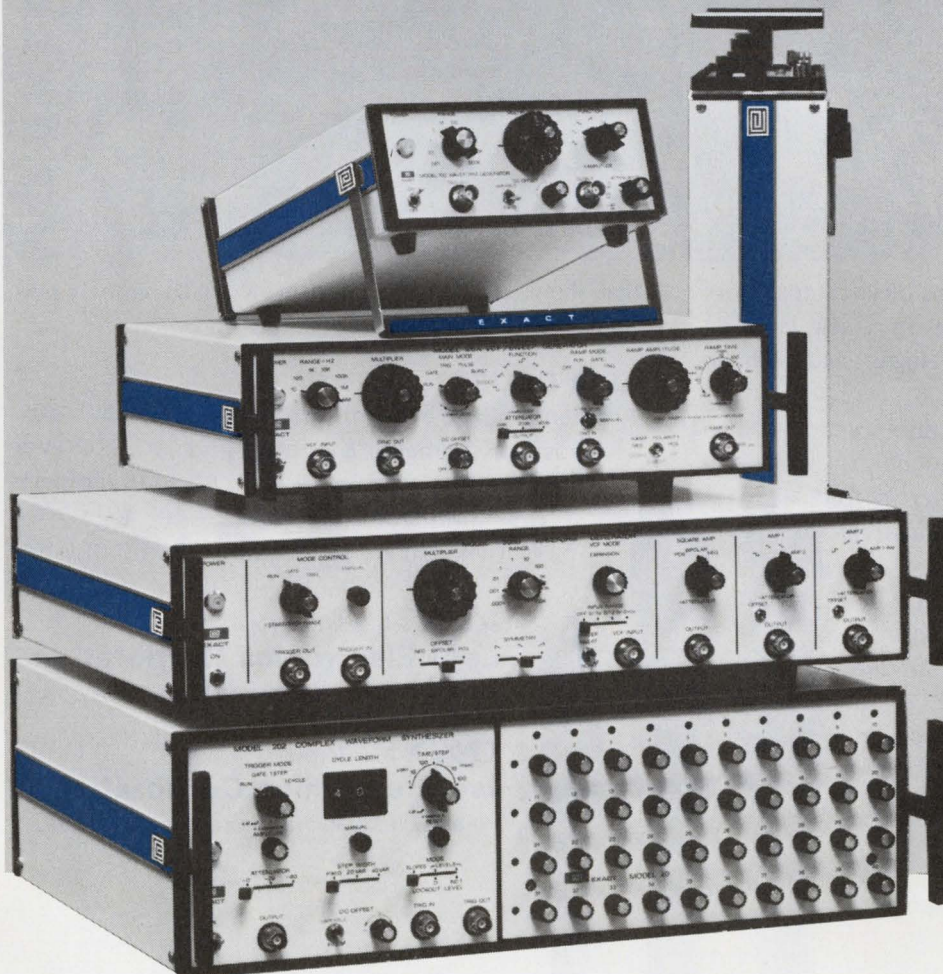

Circle Reader Service Nos.: 350 (Models 201 & 202); 351 (Model 124); 352 (Model 127); 353 (Models 605 & 606)

U. S. REPRESENTATIVES

EASTERN—Fayetteville, N.Y. (315) 637-6405 (Martin P. Andrews, Inc.); Arlington, Mass. (617) 646-1034; Glastonbury, Conn. (203) 633-0777 (Instrument Representatives, Inc.); Orlando, Fla. (305) 241-4445; Huntsville, Ala. (205) 539-0761; Winston-Salem, N.C. (919) 724-2406; Chamblee, Ga. (404) 457-7117; Rockville, Md. (301) 424-9460 (Lee Associates); King of Prussia, Pa. (215) 265-1021 (Letronix); Great Neck, N.Y. (516) 482-3500 (Measurement Technology, Inc); Beltsville, Md. (301) 345-6767 (Scientific Marketing Associates); Farmington, Mich. (313) 477-7700; Dayton, Ohio (513) 278-5873; Cleveland, Ohio (216) 333-5650; Pittsburgh, Pa. (412) 824-3760 (Carter, McCormick and Peirce, Inc.)

CENTRAL—Chicago, Ill. (312) 774-6440; Minneapolis, Minn. (612) 920-7080; Indianapolis, Ind. (317) 243-6681; Milwaukee, Wisc. (414) 482-1313 (Kenneth W. Meyers Company); Florissant, Mo. (314) 831-0342; Leavenworth, Kans. (913) 651-2929 (McGraw Engineering Company); Richardson, Texas (214) 231-6541; Houston, Texas (713) 781-2711 (Scientific Sales Company)

WESTERN—Seattle, Wash. (206) 622-0177; Portland, Ore. (503) 292-8762; Anchorage, Alaska (907) 272-5231 (Arva, Inc.); Burlingame, Calif. (415) 344-2521; Los Angeles, Calif. (213) 837-0123 (Dynamic Associates); Englewood, Colo. (303) 771-5424; Albuquerque, N.M. (505) 265-5961; Salt Lake City, Utah (801) 487-7747; Tempe, Ariz. (602) 275-7524 (Hyer Associates, Inc.)

INTERNATIONAL

Argentina—Coasin, S.A., Virrey del Pino 4071, Buenos Aires. **Australia**—Electronic Associates, Pty. Ltd., 40 Atchinson St., St. Leonards NSW 2065. **Austria**—Ingelmark Markowitsch and Co., Mariahilfer Strasse 133, Wien XV. **Belgium**—Regulation-Mesure spri, 73 Ave. R Vandendriessche, Bruxelles 15. **Brazil**—Ambries SA, Ave Grace Aranha, 226-6° Rio de Janeiro. **Canada**—Atlas Instrument Corporation, Ltd., Ontario (416) 781-6175, Quebec (514) 489-8495. **Chile**—Pentz and Cia, Ltda., Casilla 2839, Santiago. **Denmark**—ScMetric A/S, Rundforbivej 186, 2850 Naerum. **England**—Environmental Equipments, Ltd., Denton Road, Wokingham, Berkshire. **Finland**—Finn Metric OY, Poutapolku 3, Tapiola. **France**—Tranchant Electronique, 19 Rue Madame de Sanzillon, 92 Clichy. **Greece**—Marios Dalleggio Representations, 2 Alopekis St., Athens. **India**—Industrial Agencies, 111 Mahatma Gandhi Road, Bombay 1. **Iraq**—Abdul Masih E. Jwaideh, 85 Saadun St., Bagdad. **Israel**—Eastronics, Ltd. 75 Haifa Road, Tel Aviv. **Italy**—Silverstar Ltd., Via Dei Gracchi 20, 20146 Milano. **Japan**—Toyo Trading Co., Ltd., P.O. Box 5014, Tokyo. **Lebanon**—Projects, P.O. B.5281, Beirut. **Mexico**—Fredin, S.A., P.O. Box 53-958, Mexico 17 D.F. **The Netherlands**—C.N. Rood n.v., P.O. Box 42, Rijswijk (Z.H.) 2100. **New Zealand**—W and K McLean Ltd., P.O. Box 3097, Auckland; G.P.O. 496, Wellington 1. **Norway**—Metric A.S., P.B.80, Bekkelagshgd, Kongsveien 91, Oslo. **Pakistan**—Pakland Corporation, Central Commercial Area, Karachi 29. **Portugal**—Equipamentos de Laboratoria Lda, Rue Pedro Nunes 47, Lisbon. **Rep. of China**—Heighen Trading Co., Ltd., P.O. Box 1408, Taipei, Taiwan. **South Africa**—Associated Electronics (Pty) Ltd., P.O. Box 31094, Braamfontein, Johannesburg. **Spain**—Telco, S.L., Gravina 27, Madrid. **Sweden**—Scandia Metric AB, Dalvagen 12, Fack Solna, Stockholm. **Switzerland**—Omni Ray AG, Dufourstrasse 56, Zurich 8008. **West Germany**—Rohde and Schwarz Vertriebs—GMBH, Hohe Strasse 160-168, Koeln.

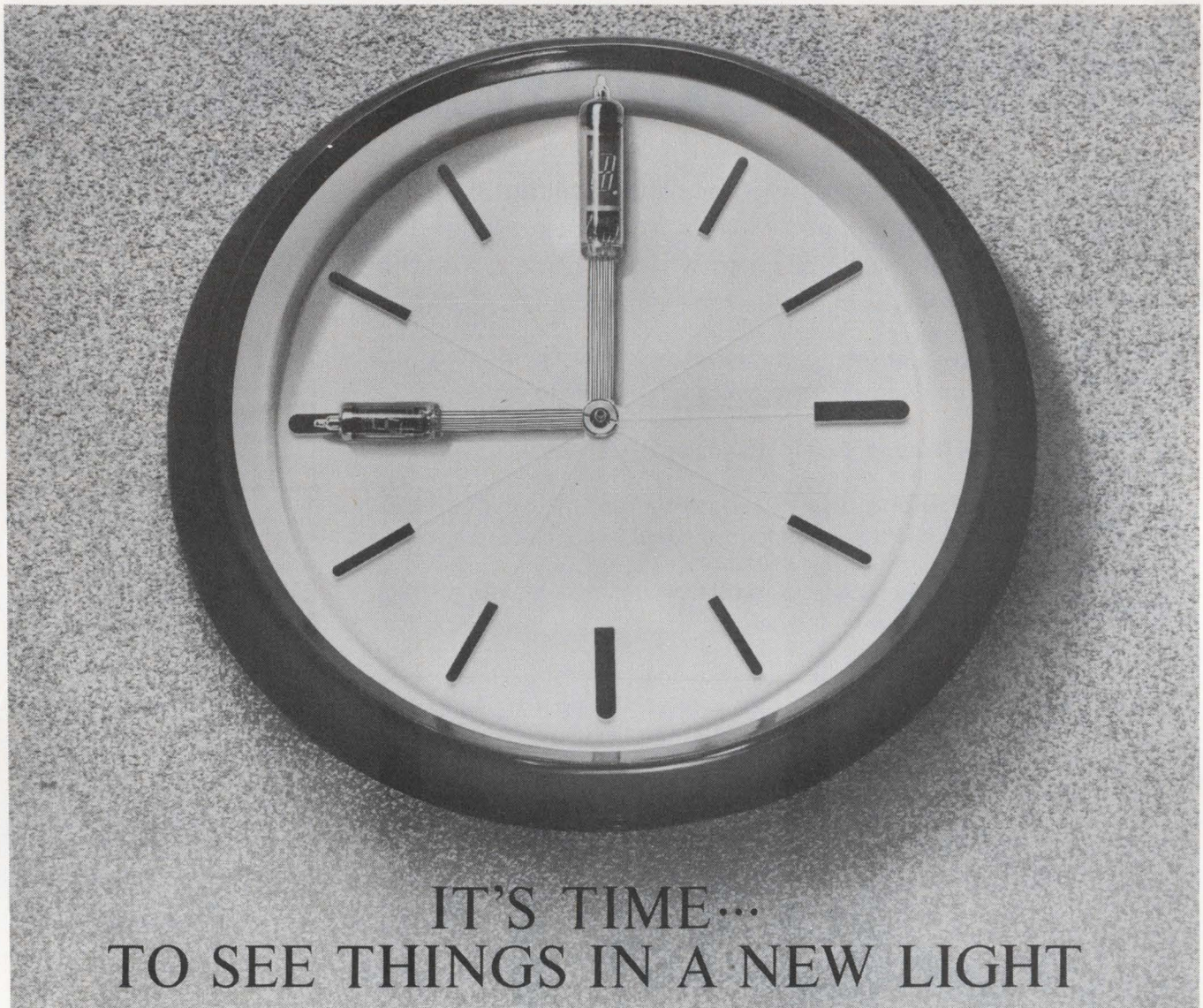

IT'S TIME... TO SEE THINGS IN A NEW LIGHT

When multi-faceted display problems dictate 9 to 9 work days, it's high time you saw things in a new light, on a single plane with no "dancing" digits and with no eye strain.

Legi DG 12C numerical indicator tube segments are an eye-easy phosphor green for a readout as bright and clear as day, legible at distances over 35 feet. These tubes offer low-voltage, low current drain, and high stability advantages so definitive and pack a performance punch so large, you can't afford not to afford to examine full particulars. They fit to the "T" perfectly portable and circuit-board mounting applications and are available at mass production prices. Look at these important particulars, then write for comprehensive data

that show display tube performance in an entirely new light:

LEGI DG 12C

Filament voltage at 95 mA 0.85 volts \pm 10%
 Phosphor segments & control grid 20 Vdc
 Brightness 80 foot -lamberts
 Operating temperature -10° to $+70^{\circ}$ C
 * Dynamic life expectancy 200,000 hrs.

U.S. PATENT 3508101

Legi Sole U.S. Distributor:

Legi Electronics Corporation

3118 West Jefferson Blvd. Los Angeles, California 90018 U.S.A.
 Phone: RE 3-4508, 733-9105

I/E Manufacturer:

Ise Electronics Corporation

P.O. Box 46, Ise City Mie Pref., Japan Phone: Mie (059627)-26

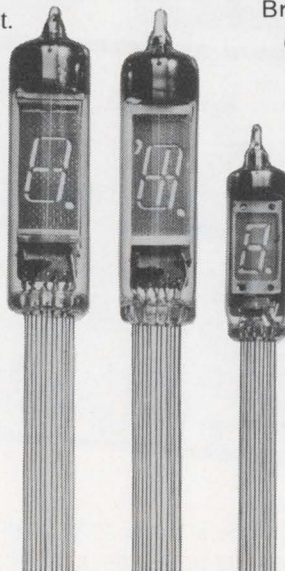

DG 12H

DG 10A

INFORMATION RETRIEVAL NUMBER 14

14 ways to keep current on computer languages...equipment...terminology

Discovering Basic: A Problem Solving Approach Robert E. Smith. This new course starts the reader programming on page three, pinpointing the vocabulary of BASIC as it develops skill and confidence. Clear explanations speed the reader through the brief exercises and reviews which reflect this language's growing importance in timesharing systems. More than thirty-five pages of programs for the lessons and reviews are easily located at the back of the book. 224 pp., 5 3/8 x 8 1/4, illus., paper, #5783, \$5.95; cloth, #5784, \$7.95

Basic Basic: An Introduction to Computer Programming in Basic Language James S. Coan. Written in a precalculus mathematics setting, this new text is designed to work in conjunction with a math course or as a separate programming course. Progressing from short complete programs to more sophisticated problems, the text encourages the use of flowcharts as an aid in programming. Solutions to even-numbered problems appear in the text; the remainder, in a separate teacher's guide. 272 pp., 6 x 9, illus., paper, #5872; cloth, #5873

Comprehensive Standard Fortran Programming James N. Haag. This up-to-date course teaches how to program effectively using the full version of FORTRAN IV as standardized by the U.S.A. Standards Institute. From the outset, portions of the language are applied in writing programs drawn from a variety of disciplines. Mathematics are kept to a minimum as the book provides mastery of the thirty-two different FORTRAN instructions, as well as an understanding of computer capabilities and limitations. This well-organized, clearly written book is ideally suited for either self-study or classroom use. 312 pp., 7 1/8 x 9 3/4, illus., paper, #5811, \$6.95; cloth, #5812, \$8.95

Comprehensive Fortran Programming James N. Haag. The highly successful course in FORTRAN II teaches the language as used by the IBM 1620 compiler with an attached 1311 Disk Drive, with adaptations to suit other systems. Programming begins immediately, with applications to the BEST-SAM areas: Business, Engineering, Science, Technology, Social Science, Agriculture, and Mathematics. 246 pp., 7 3/8 x 10 1/8, illus., paper, #5646, \$5.95

Basics of Digital Computers, Revised Second Edition John S. Murphy. Offering a complete foundation in today's equipment and systems, the fully updated edition of this three-volume work is excellent for self-teaching or classroom use. Free of needlessly confusing jargon, it includes over 300 all-new illustrations to drive home its discussion of concepts relevant to all systems. The first volume explains how information is programmed into the machine to produce an answer or to be stored for later use. Volume two covers the construction and function of the various components. The linkup and control of an overall system, covered in volume three, completes the background needed to master specific systems. 391 pp., 6 x 9, illus. 3 vol. set, paper, #0737, \$11.25; 3 vol. combined, cloth, \$9.95; indiv. paper vols., #0738, #0739, #0740, \$3.75

Basics of Digital Computer Programming John S. Murphy. This invaluable introduction to business-data programming uses general programming examples to illustrate practical computer applications. Discussion is clarified through continual reference to the internal organization of a typical computer. 118 pp., 6 x 9, illus., paper, #0405, \$3.95

Basics of Analog Computers T. D. Truitt and A. E. Rogers. Three volumes in one—a concise review of the principles, hardware, and applications of the modern analog computer. It reveals the principles of analysis through analogy and simulation. 400 pp., 6 x 9, illus., cloth, #0256, \$12.50

Computer Arithmetic Henry Jacobowitz. A refresher course in the basic operations of all positional number systems with applications in computers, this compact volume explains binary, octal, hexadecimal, and ternary arithmetic, along with conversion methods. 128 pp., 5 1/2 x 8 1/2, illus., paper, #0297, \$3.75

Computer Numbering Systems and Binary Arithmetic Training Systems, Inc., and Stanley L. Levine. This programmed course proceeds gradually through all the required mathematical processes. No previous knowledge of binary or octal numbering systems, or with computers, is needed. 232 pp., 6 x 9, paper, #0380, \$5.45

Standard Dictionary of Computers and Information Processing Martin H. Weik. Widely praised for its broad scope, detailed definitions, and illustrative examples, this essential reference encompasses more than 10,000 hardware and software terms in general use throughout the burgeoning field of computers and their applications. Thorough cross-referencing permits complete mastery of the vocabulary of hundreds of topics: programming and computer engineering to input-output devices and checking systems. The Computer Tree, reproduced on the endpapers, traces the lineage of more than 500 computer models built to date. 336 pp., 6 x 9, illus., cloth, #5677, \$10.95

Data Transmission and Data Processing Dictionary James F. Holmes. A practical source to the proper definitions for more than 3,000 terms used in data processing, telephony, telegraphy, facsimile, and data transmission work. 103 pp., 6 x 9, paper, #0396, \$2.50

Understanding Digital Computers Ronald Benrey. A comprehensive guide for those who need in-depth understanding of computers, but not a technical grasp of the equipment. Describing computers in terms of similar, and simple building blocks that make up a system, the book stresses the function of these elements, rather than their actual electronic construction. Programming, binary arithmetic, logical design, and other key topics are fully explained. 166 pp., 6 x 9, illus., paper, #0473, \$4.75

Digital Magnetic Tape Recording Bernard B. Bycer. This unique design tool fully describes functions and operations, also providing valuable data for specification, purchase and use of the equipment. 328 pp., 6 x 9, illus., cloth, #5031, \$12.50

How to Build a Working Digital Computer Edward Alcosser, James P. Phillips, and Allen Wolk. Popular book provides complete instructions for building an inexpensive computer that can be programmed to solve problems. 176 pp., 6 x 9, illus., paper, #0748, \$4.45

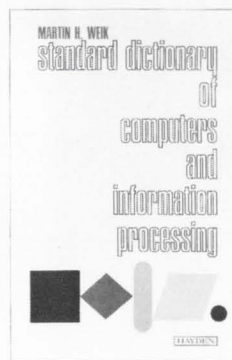
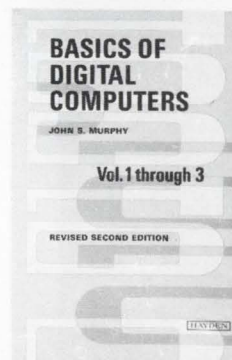

Send no money — clip or duplicate this coupon today!

**15-day
FREE
Examination**



Please send the book(s) listed on a 15-day free examination basis. At the end of that time, I will remit payment, plus postage, or return the book(s) without further obligation.

CAT. #	TITLE	PRICE	Name _____
_____	_____	_____	Firm/Institution _____
_____	_____	_____	Address _____
_____	_____	_____	City/State _____ Zip _____
_____	_____	_____	<input type="checkbox"/> Payment enclosed (Hayden pays postage). Same return guarantee. On all overseas orders, payment in U.S. dollars must be enclosed.

HAYDEN BOOK COMPANY, INC. 116 W. 14 St., N.Y., N.Y. 10011

71-4-1

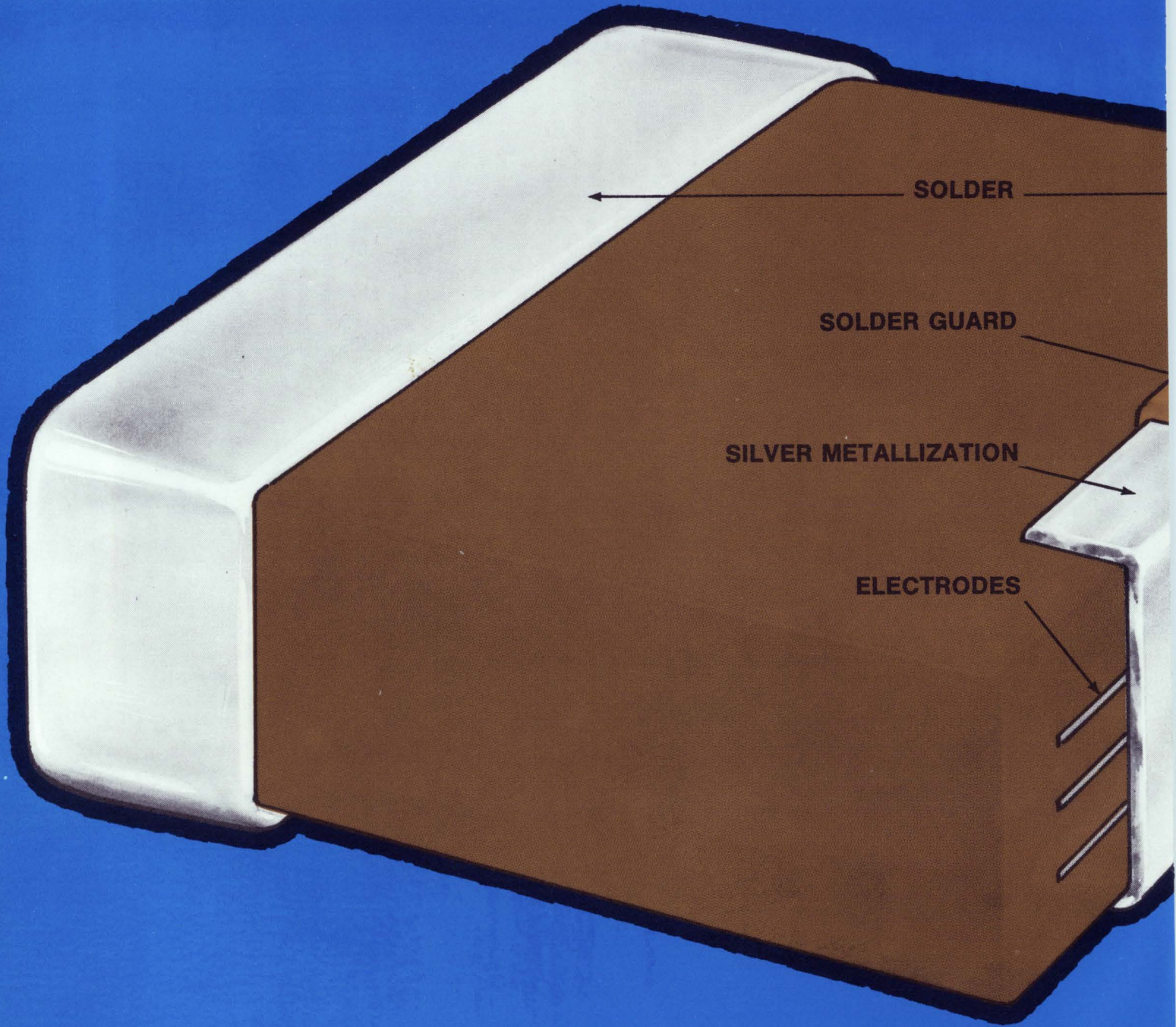

SOLDER

SOLDER GUARD

SILVER METALLIZATION

ELECTRODES

KEMET[®] **solder guard is here!**



A NEW GENERATION CERAMIC CHIP CAPACITOR WITH A UNIQUE COPPER BARRIER LAYER IN THE END METALLIZATION THAT PREVENTS SILVER LEACHING OR SCAVENGING DURING SOLDER REFLOW ASSEMBLY OPERATIONS. . . .!!

AN EXCLUSIVE PROCESS THAT IS STANDARD AT NO EXTRA COST—ON *ALL KEMET CERAMIC CHIPS. KEMET Solder Guard does what other Ceramic Chip Capacitors fail to do—they withstand the worst conditions of solder reflow with little or no degradation of electrical continuity and performance. □ And that's not all—they are supplied pre-tinned for easy application in your circuit—they come in six popular sizes in 2 precision dielectrics — KEMET's "BX" which optimizes high capacitance with stable performance, and "NPO" which provides outstanding stability in all applications. Capacitance values 10 to 330,000pf, 50 and 100 VDC. □ More information and a Chip Sampler containing 30 KEMET Solder Guard Chips are yours for the asking. Forward request on company letterhead to Union Carbide Corporation, Components Department, P. O. Box 5928, Greenville, South Carolina 29606. Phone (803)-963-7421.

*KEMET chips are also available with conventional end metallizations such as silver, palladium alloys, gold, etc.

COMPONENTS DEPARTMENT

**UNION
CARBIDE**

THE DISCOVERY COMPANY

now you can reach
more engineers
and reach them
faster...

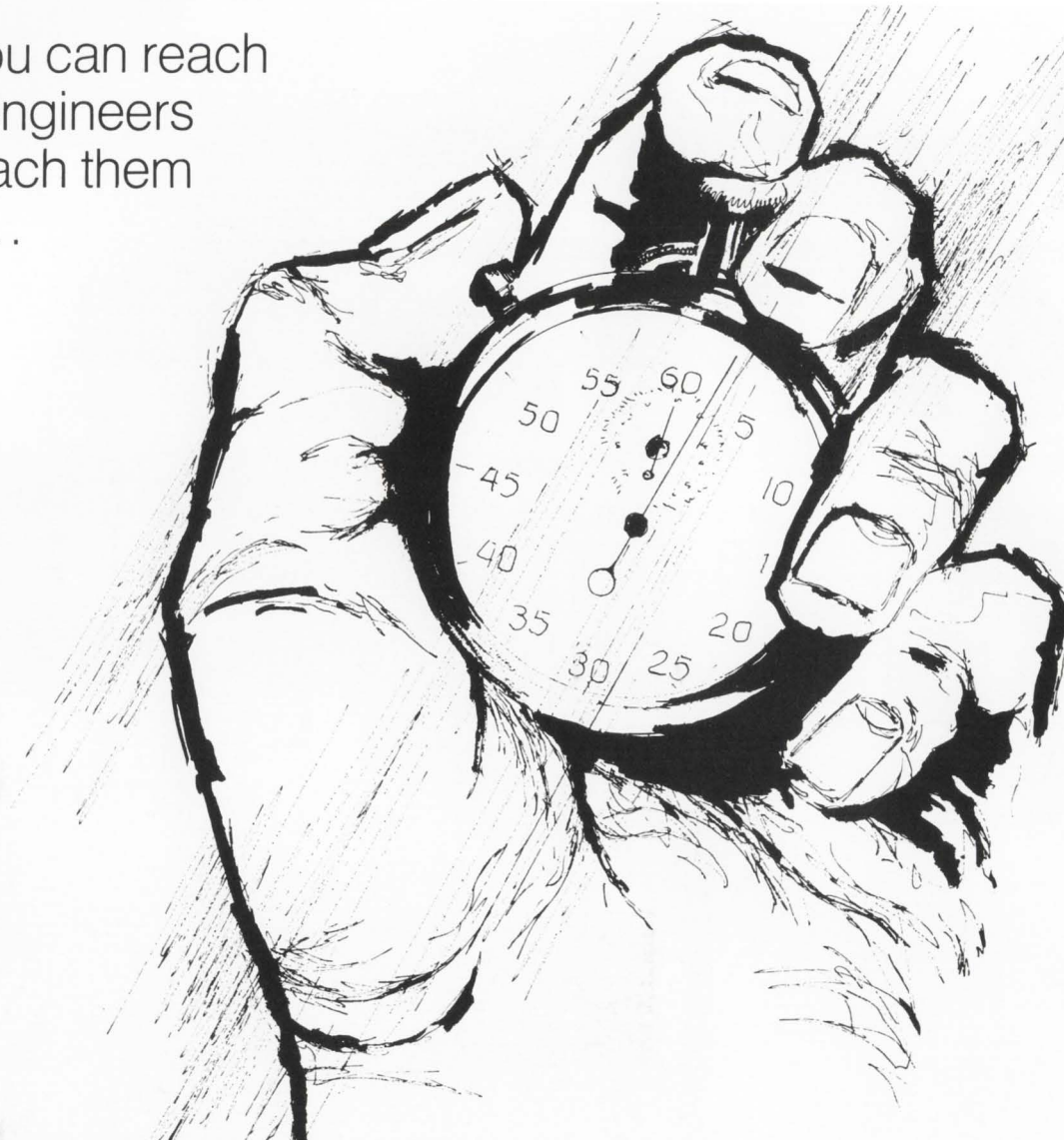

Electronic Design's *NEW*

FAST CLOSE FORM

Marketing and salespeople can't specify your products . . . engineers can. Products don't move through distributors until they are specified by engineers. Now there's a way to reach *more** EOEM engineers and reach them *faster*. It's Electronic Design's new FAST CLOSE FORM—right up front in the News Section. You can get out your new product story, your price announcements or delivery and distribution information, quickly, while they're still hot. Closing date for film positives is only *24 hours before press time . . . 48 hours before the issue mails*. You save 3 full weeks over normal closing. The form will accept full pages or spreads in b&w or 2-color; premium is only \$150 per insertion. Call your Electronic Design representative today for complete information.

*Electronic Design has 72,271 EOEM engineers and engineering managers—53,372 more than Electronic News . . . 37,998 more than Electronics. Source: December, 1969 BPA and ABC Publisher's Statements.

ELECTRONIC DESIGN FAST CLOSE SCHEDULE

(Post on your production bulletin board.)

ISSUE DATE	REGULAR CLOSING	FAST CLOSE		ISSUE DATE	REGULAR CLOSING	FAST CLOSE	
		ORDER IN N.Y. OFFICE	FILM POS. AT PRINTER			ORDER IN N.Y. OFFICE	FILM POS. AT PRINTER
June 7	May 4	May 22	May 25	Sept. 27	Aug. 24	Sept. 11	Sept. 14
June 21	May 18	June 5	June 8	Oct. 11	Sept. 8	Sept. 25	Sept. 28
July 5	June 1	June 19	June 22	Oct. 25	Sept. 21	Oct. 9	Oct. 12
July 19	June 15	July 3	July 6	Nov. 8	Oct. 5	Oct. 23	Oct. 26
Aug. 2	June 29	July 17	July 20	Nov. 22	Oct. 19	Nov. 6	Nov. 9
Aug. 16	July 13	July 31	Aug. 3	Dec. 6	Nov. 2	Nov. 20	Nov. 23
Sept. 1	July 27	Aug. 14	Aug. 17	Dec. 20	Nov. 16	Dec. 4	Dec. 7
Sept. 13	Aug. 10	Aug. 28	Aug. 31				



Pick your performance.

Qualidyne goes the whole route in linear op amps.

Whatever you want, we have.

And every linear IC we produce has the same quality as the next. Thanks to TWF (Tailored Wafer Fabrication).

Our exclusive TWF process lets us produce linear amplifiers of unusually high quality for prices that are down to earth.

Why? Because this proprietary process makes possible initial wafer yields nearly *twice* the industry average.

For the amplifier you want—from micro power to general purpose to super op amps—just let us know what you want. We'll send you the one to fill your needs.

Tailored Wafer
Fabrication:
a unique innovation
in semiconductor
manufacture.



**Qualidyne
Corporation**

Want more information on the *Linear Op Amp Family* from Qualidyne? Contact your Qualidyne representative, or contact us directly. If you need data on our diode arrays, monolithic duals, drivers/receivers or semiconductor memories, do likewise.

Qualidyne Corporation / 3699 Tahoe Way, Santa Clara, California 95051 / (408) 738-0120

INFORMATION RETRIEVAL NUMBER 16

...want a tantalum capacitor with proven performance?

Buy TYPE 150D TANTALEX[®] SOLID-ELECTROLYTE CAPACITORS

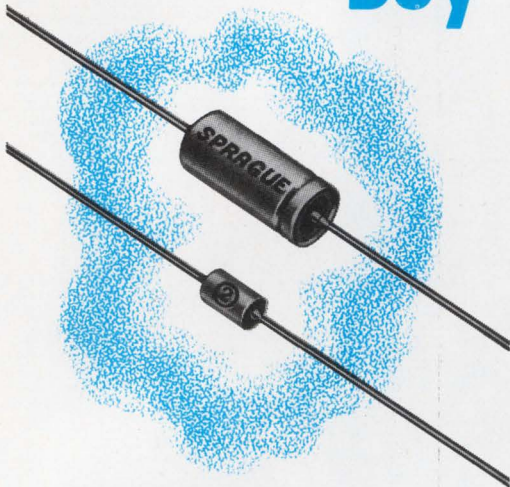

INFORMATION RETRIEVAL NUMBER 882

- Hermetically-sealed in metal cases
- Four case sizes, ranging from 1/4" to 3/4" length
- Value-packed performance characteristics—low impedances at high frequencies, low dissipation factor, minimal capacitance drift with temperature, practically no change in capacitance with life
- Low leakage current limits
- New higher capacitance ratings
- Request Engineering Bulletin 3520F

4SC-9144R3

Buy resistors with built-in dependability...

Vitreous-enamel BLUE JACKET[®] POWER WIREWOUND RESISTORS

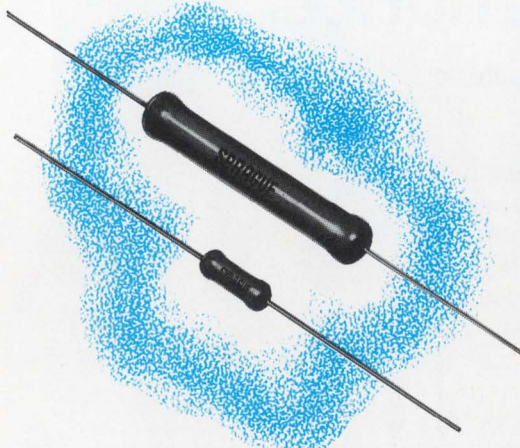

INFORMATION RETRIEVAL NUMBER 883

For Engineering Bulletins as noted above, write to:
Technical Literature Service, Sprague Electric Co., 347
Marshall Street, North Adams, Massachusetts 01247.

- All-welded end-cap construction eliminates moisture along leads, also anchors leads securely to resistor body
- Expansion coefficients of vitreous coating, ceramic core, and end caps are closely matched
- Standard wattage ratings include 1, 2, 2.5, 3, 5, 7, 10, and 11 watts
- Also available with radial tab terminals in ratings from 8 to 230 watts
- Request Engineering Bulletin 7410D

4SR-9145R2

THE BROAD-LINE PRODUCER OF ELECTRONIC PARTS



'Sprague' and '®' are registered trademarks of the Sprague Electric Co.

Highlighting

THE ISSUE

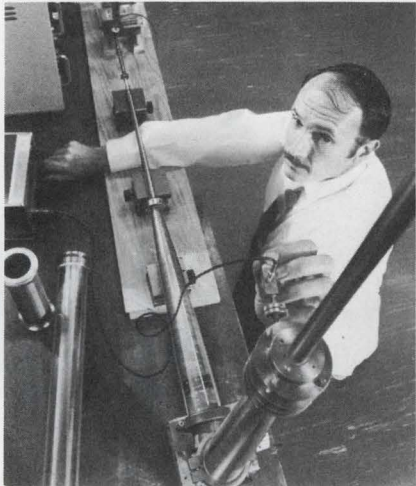

A revolution in telephone transmission appears in the making in the 1970s. After years of reliance on coaxial cable and microwave links, the Bell System is turning seriously to new technology.

Two-inch pipes, or waveguides—similar to those on the bench above—will be used in a new communications system scheduled for a 1974 field trial by Bell Labs. Earl Harkness, a technician, tests ways to amplify the high-frequency radio waves traveling through the waveguide.

Page 30

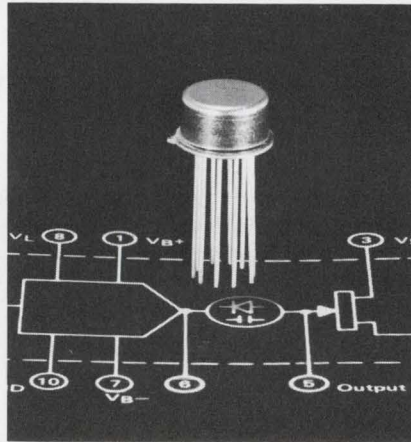

Able to switch ± 10 -V signals directly from DTL or TTL levels, a new general-purpose FET analog gate comes complete with a driver for a price of only \$8.10 in single quantities and \$6 in lots of 100 to 249 units.

This new break-before-make switch uses a monolithic switching circuit as a driver to provide the advantages of small size and operates over the military temperature range of -55 to $+125^\circ\text{C}$.

A high typical immunity of 1.5 V is provided from logic noise, and maximum resistance is 60 ohms. Propagation delay to logic state ZERO is $0.5 \mu\text{s}$, and $1 \mu\text{s}$ to logic state ONE.

Page 72

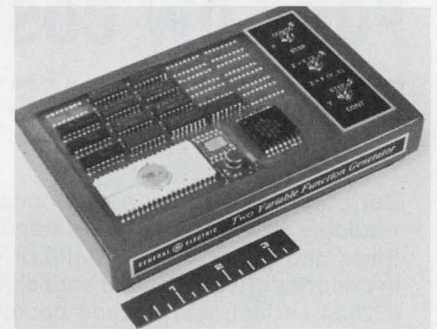

Arbitrary functions of one or two variables are frequently required in many types of electronic equipment. Several techniques for their generation have been proposed, but the problems of accuracy and complexity have never been satisfactorily solved. Here is a method that uses a read-only memory (ROM) to store discrete values of the function and time-averaging interpolation to construct straightline segments between the data points.

Hardware requirements for very complicated functions are not large. And the ROM time-averaging function generators offer excellent repeatability and high operating speed.

Page 42

NEW BURROUGHS' NIXIE® TUBE

DRIVER MODULES

COMBINE

FOR LOW COST

READOUT SYSTEM FLEXIBILITY

Burroughs introduces a new concept in packaging convenience for numeric readouts of 3 to 15 digits — standard module complete with NIXIE tubes and ready to use — with or without a bezel. For optimum flexibility in decoder drivers (C2502 series), decoder drivers with memory (C2504 series), and decade counters with memory (C2506 series) use plug-in modules of 3, 4 or 5 digits singly or in combination to meet exact requirements for any readout of 3 to 15 digits. Available immediately for off-the-shelf delivery. Burroughs' new modular assemblies provide unprecedented advantages of cost, performance and application flexibility.

Write today for descriptive brochure.

Burroughs Corporation, Electronics Components Division,
P.O. Box 1226, Plainfield, New Jersey 07061.
Tel.: (201) 757-3400

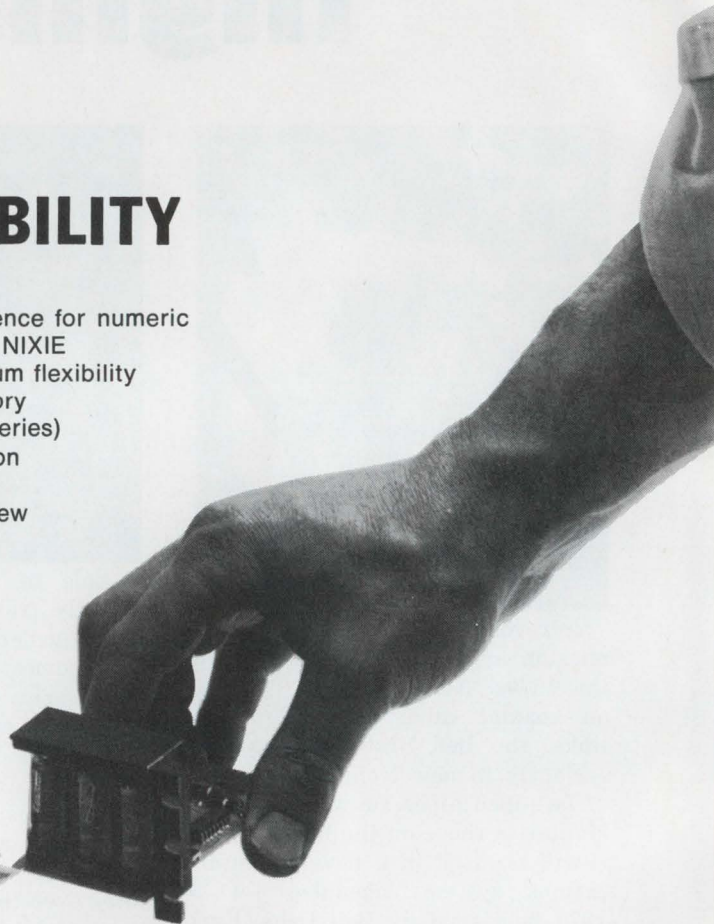

JUST ADD A MODULE

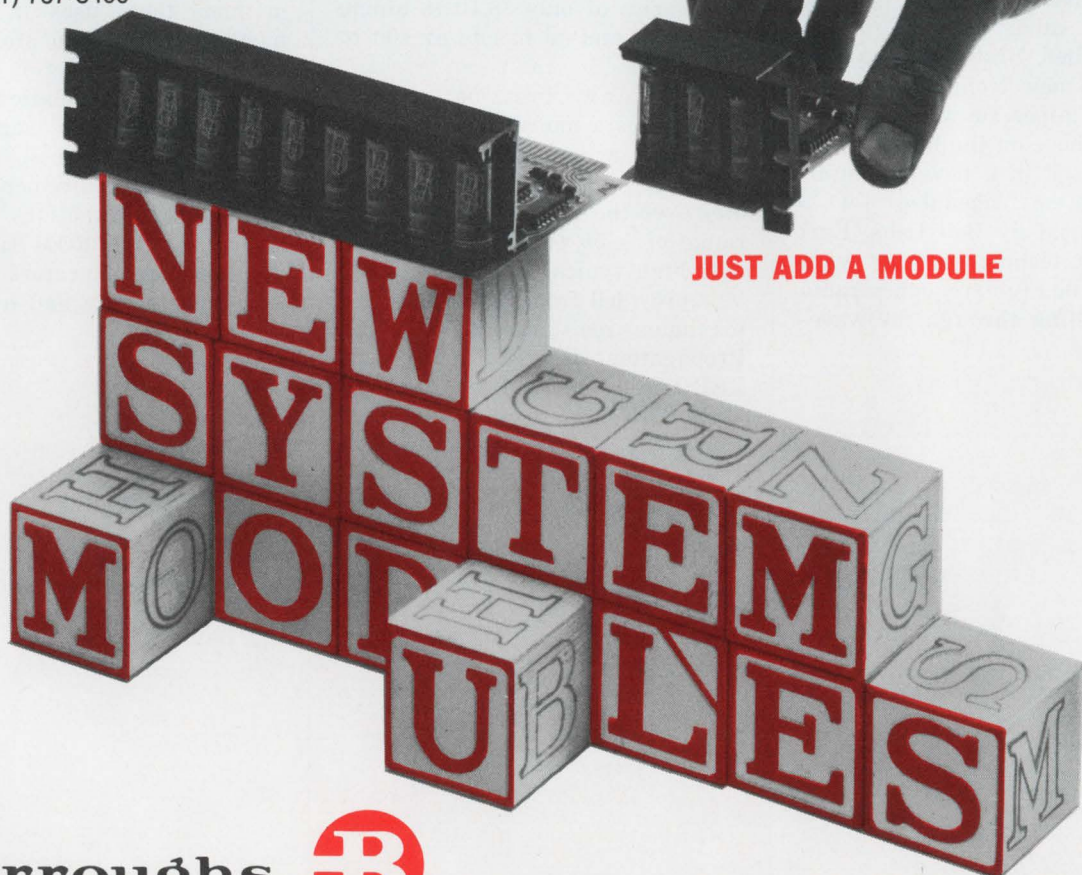

Burroughs



Military R&D spurring new civilian applications

R&D conducted originally for the military is paying off increasingly in civilian applications.

Among the developments announced this month:

- The first phased-array radar for general aviation.
- The use of side-looking radar for geologic reconnaissance.
- A computer-display anticollision system for civilian ships.

Phased-array antenna shown

The phased-array antenna for general aviation—designated the AVQ-21 by its manufacturer, the RCA Aviation Equipment Dept. in Los Angeles—was shown publicly for the first time in the National Business Aircraft Association meeting in Denver.

According to George Jung, a microwave engineer who worked on the system: "By going to a 12-inch phased array instead of a 12-inch parabolic, we picked up an additional 1.8 dB of antenna gain. In a two-way system, such as a radar, this means that we have 3.6 dB of additional system gain."

Kay Fujimoto, AVQ-21 project leader, notes: "The additional gain allows a reduction in the transmitter power required for operation at a 180-nautical-mile range of from about 20 kw to 8 kw."

Fujimoto also points out that because of the decrease in transmitter power, the system is 17 pounds lighter than its parabolic counterpart and requires far less input power.

Another advantage resulting from the lower transmitter power is that the radar can operate at higher altitudes without corona problems. It has been tested without corona to about 55,000 feet, the manufacturer says.

The operating frequency of the transmitter is 9345 MHz. The receiver is a double-conversion system.

Intended primarily for the general-aviation jet market, the system will sell for about \$17,000.

Side-looking radar for hire

Westinghouse Electric Corp. of Pittsburgh has equipped a DC-6B

aircraft with "the only side-look radar presently available for hire in geologic survey work."

The mosaic maps produced by the radar imaging resemble aerial photography, but since signals in the Ka Band (26.5 to 40 GHz) penetrate clouds, foliage and grass cover, the received picture shows contours of the earth's surface that would otherwise remain hidden. It is these hitherto unseen formations that help geologists identify areas of greatest promise for mining and petroleum.

The Westinghouse-equipped aircraft is slated to work for oil companies in Alaska's North Slope next year, and after that, the company says, plans call for surveys in Canada and in Africa.

Collision avoidance at sea

By applying military technology to the peacetime problem of preventing collisions at sea, Iotron Corp. of Bedford, Mass., has developed a computer-display system that takes data from any ordinary shipboard radar and calculates and displays the positions, courses, velocities and projected positions of nearby ships.

The system, called Digiplot, analyzes all echoes detected by the ship's radar and automatically acquires, tracks and plots the most threatening ships, up to a total of 40, within 12 miles. An automatic alarm is triggered on the basis of "closest point of approach distance (CPA)" and "time to CPA," as set by the operator. (See ED 17, Aug. 16, 1970, p. 38.)

Riskless contract offered by RCA to computer user

RCA's new line of computers is being offered to current users of IBM 360/30, 40 and 50 with a guarantee of successful conversion. This unique policy was announced by Robert W. Sarnoff, president of RCA, in conjunction with the unveiling of models 2, 3, 6 and 7.

The new computers are described as offering considerably greater memory capacity than current IBM equipment at no increase in cost. The memories range from 131-k bytes in the RCA 2 to 512-k bytes in the RCA 7.

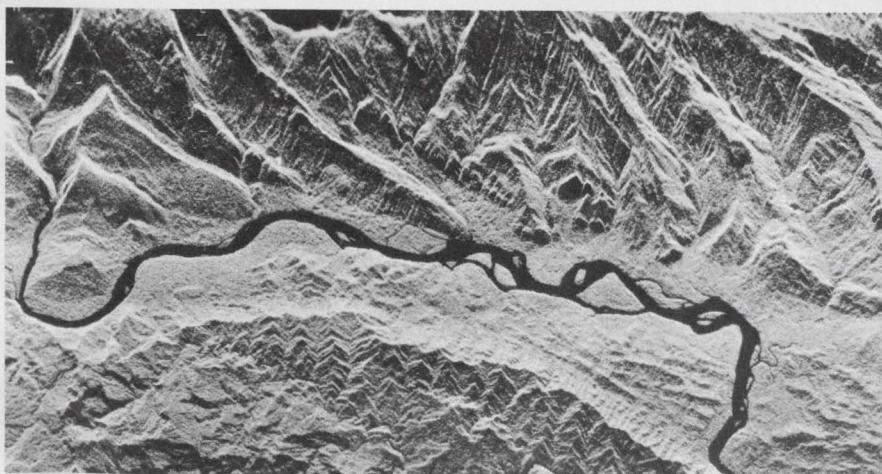

Side look radar image of region of New Guinea resembles aerial photo. Radar is aiding geologists in the search for ore and oil.

Sarnoff said, "The new business policy should go a long way toward removing the doubt that has plagued those who must decide whether to move from one manufacturer's system to another."

Two of the new computers, models 3 and 7, make use of virtual memory to give the user almost unlimited memory capabilities within the framework of a standard main memory. This is accomplished by dynamic linking of the computer to auxiliary memories. Up to 2 million bytes in model 3 and 8 million bytes in model 7 are possible.

The guaranteed conversion policy will be limited initially to current installations of 360/30, 40 and 50, which operate under IBM's disc operating system. This restriction has been made because "the concept is an entirely new one," according to L. E. Donegan, Jr., vice president of the RCA Computer Systems Division that makes the new machines.

Two-week space tour envisioned in 10 years

Ten or 15% of all scientists and engineers who are now 25 years old can look forward to orbiting the earth in a space station by the time they are 35, says Dr. Hans Mark, director of NASA's Ames Research Center. He made this observation at a NASA-sponsored meeting of 450 scientists and technical leaders from universities and industries all over the country at Moffett Field, Calif., early this month.

NASA can develop a space station for 24 people and shuttle personnel from earth to space and back every two weeks, Dr. Mark said. "Over a 4-year-period," he noted, "that would add up to about 2000 people."

However, he expressed fears that too much emphasis is being placed on the kinds of experiments that should go into the station and not enough emphasis on the people who will go and what their requirements will be. NASA leaders, he

said, should start contacting young science graduate students now to find out their ideas about such an undertaking.

The space-station program is in its early planning stages and is not yet funded. However, a preliminary Skylab made with Apollo hardware, and containing a telescope for solar observations and remote sensing equipment for earth resources experiments, is scheduled for launch in 1972. It will orbit three astronauts for periods up to 56 days.

Color images copied in 3 seconds on any paper

In three seconds or less positive black-and-white or color images can now be produced on any kind of paper, according to Electroprint, Inc., Palo Alto, Calif.

The new technique, says company president Samuel B. MacFarlane, Jr., has applications as a black-and-white or color copy machine, a low-cost camera, or a computer output device where it could provide hard copy on plain paper either from the CRT screen or other light source such as light-emitting diodes. It could also be used as a high-speed printer, producing alphanumeric output directly from digital signals. Characters can be printed serially, according to MacFarlane, so that the user can make changes as he goes along. Yet it will be able to print up to 1000 characters per second.

In all these applications, a charge image is produced on a photoconductive screen, and suspended ink particles are propelled through the screen by electrostatic forces onto a piece of paper behind it.

First all-LSI computer fits on a desk top

An all-LSI computer with capabilities equivalent to an IBM 360/30 can fit on top of an ordinary desk, according to its manufacturer, Four-Phase Systems, Cupertino, Calif. Lee Boysel, president of Four-Phase, said that the central processor of the unit is contained on a single 8-by-10-inch card containing 12 semiconductor chips.

The computer, System IV/70, is designated for data entry and retrieval from data bases and is expected to be available in early 1971. The first showing of the system will be at the Fall Joint Computer Conference in Houston in November.

The use of MOS/LSI exclusively in memory and control circuits was made possible by having complete in-house semiconductor design and manufacturing, according to Boysel. A full line of peripherals and compatibility with System 360 are among the features of the new computer.

Riders must fasten seat belts—or else

"Lock your seat belt or the car won't start." That's the warning a new Autosafe seat-belt system gives its users with a blinking indicator and an attention-getting beeper. The new system developed by Irvin Industries, Greenwich, Conn., has pressure-sensitive switches under each seat plus a mercury switch in each seat-belt buckle. These are connected by means of an SCR to the starter solenoid. Connecting all seat-belts causes the SCR to conduct, energizing the starter solenoid by means of the key.

The system has built-in logic that tells how many people are in the car and when all seat belts have been secured.

For off-track betting: a new computer system

A sophisticated software and hardware system has been ordered by New York City to help it to operate as a legal bookie.

Under a new revenue-raising law, the city has set up an Off-Track Betting Corp. and will begin taking bets on horse races shortly. It has selected Computer Sciences Corp., Los Angeles, from among 12 bidders to design its bookie system.

The requirements include a data bank, computational ability and new terminal hardware. The data bank will keep records, especially the balances of telephone customers, while the computer figures the latest odds. ■■



MAKE YOUR CONNECTIONS: FAST. With Molex standard and miniature connectors. They're easier to work with. Simplify wiring. Speed production. Save assembly steps. Make installation and servicing extra easy, too. This is why circuitry idea men everywhere are making connections with Molex. From one circuit to 104 or more. Production keyed and available in a variety of colors to meet design requirements. Molex has the

connector. Plus the design and engineering capability to solve the most complex wiring problems . . . fast. For a colorful free sample of the Molex connector write: Molex Incorporated, Downers Grove, Illinois 60515. Or you can make connections by calling (312) 969-4550.

... creating components that simplify circuitry



What made Amperex a leading supplier of trimmer capacitors... all of a sudden?

The addition of Film Dielectrics, for one thing...

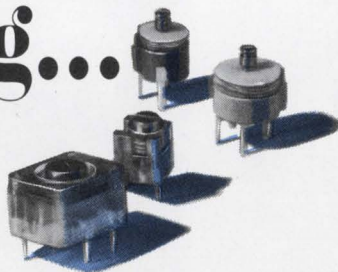

Yesterday film dielectric trimmer capacitors were not available. Today Amperex gives you a choice of complete lines of film dielectric and tubular ceramic types... both lines available in production quantities. The excellent characteristics of polyethylene and PTFE films result in advantages that were never available in trimmers using any other dielectric material. Easy to specify, easy to use... as few as three or four film types usually cover the entire range of trimmer requirements for communications equipment designs, TV receivers and industrial applications.

Film dielectrics offer high total capacitance (up to 100 pf) and large capacitance swings along with minimum "zero" capacitance. They show far less temperature-dependency and they permit extremely accurate setting of trimming capacity.

Designed for mounting on P.C. boards, these new film types are available in single-stator, split-stator and differential versions.

In addition to the film dielectrics, Amperex offers a complete line of tubular ceramic trimmers for UHF radio and TV and industrial applications.

Included are "standup" types for mounting on P.C. boards and several industrial types that replace corresponding MIL-C-14409B trimmers at significantly lower cost... with no compromise in performance.

For additional information and new short-form catalog of the entire line of Amperex components, write: Amperex Electronic Corporation, Component Div., Hauppauge, N. Y. 11787. Telephone: 516-234-7000.

Amperex®

TOMORROW'S THINKING IN TODAY'S PRODUCTS
A NORTH AMERICAN PHILIPS COMPANY

Design the accidents out of your product!

Good record-keeping and failure analysis advised to curb the increasing damage suits by consumers

Jim McDermott
East Coast Editor

Ten years ago if an accident occurred in the use of an electronic product, not too many people hounded the designer. Today, with more and more consumers itching to sue, manufacturers are calling on designers to prevent accidents in the use of their products before they occur.

The problem was discussed recently at the First Product Liability Conference, held at the Newark (N. J.) College of Engineering.

In a keynote address to the conference, Harry M. Philo of Detroit, a lawyer who specializes in product design litigation, summed up the legal problem that designers face this way:

"A defective product is one which is not reasonably safe for reasonably foreseeable uses, intended or *unintended**, or one which presents an unreasonable or unacceptable risk of injury.

"Any risk of serious injury or death is unacceptable if reasonable accident-prevention methods can eliminate it *and the risk is not known to the user**. A 100% risk [is acceptable] if the injury is minimal and the risk is known by the user. One seeks to eliminate the hazard or the risk. If this cannot be done, then it is necessary to guard the hazard, minimize the risk, and instruct and warn of the remaining risk."

Several approaches to accident prevention were discussed at the conference, all based on the user's experience. But one area brought solid agreement: the need for good records. It was expressed by Dr. Thomas H. F. Smith, director of scientific services for the Lehn & Fink Products Co., Montvale, N. J.,

as follows:

"Proper record-keeping can be the best insurance against liability that the manufacturer can hope to have. Documentation for liability prevention and protection applies to all aspects of the product, including design, manufacture, sales and service."

Record-keeping is essential because of the widespread application by the courts of the doctrine of "strict liability." This, Smith explained, means that a plaintiff need not demonstrate negligence in the manufacture of a product, but simply that a defect in it existed, whether or not the manufacturer knew it existed or could have prevented it. In many cases, the manufacturer has been held responsible for use of his product that was not originally intended but that the court said was foreseeable. In other words, the manufacturer must anticipate possible misuse of his product. If he doesn't, the plaintiff's lawyer may cite it as a lack of "due care."

Thomas A. Daly, director of reliability and product safety for Westinghouse Electric Corp., Pittsburgh, pointed out that diagrams and charts developed through fail-

ure-mode analysis could be effective evidence of the manufacturer's intent to produce a safe product.

An even better technique, according to Paul Gottfried, principal scientist with Booz-Allen Applied Research, Inc., Bethesda, Md., is called fault-tree analysis. Developed by Bell Telephone Laboratories, fault-tree analysis starts from the failure of the device and proceeds to the cause. This approach is the opposite of that of conventional failure-mode analysis, which starts with the cause.

By starting with the highest level of assembly rather than the lowest, a designer can determine the relationships between functional effects and product elements. Fault-tree analysis also can be terminated as soon as significant information is obtained; the failure-mode method must be developed completely to get the desired results. Finally the tree can be started before the product design has been completed and all components have been specified.

A big obstacle that manufacturers face in damage suits, the conference was told, is that juries are comprised of nontechnical people.

Albert Goodman, director of quality assurance for Eaton, Yale & Towne, manufacturers of industrial machinery, made these points:

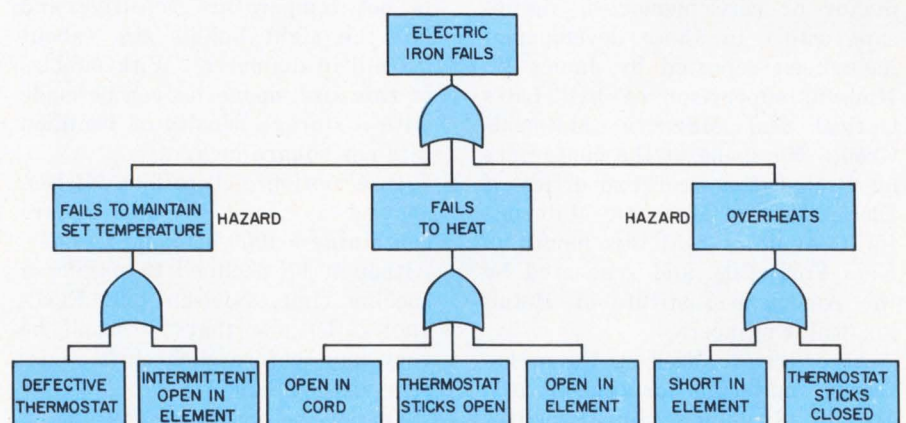

An example of failure analysis using the fault-tree form. The analyst assumes his product has failed and then proceeds from the symptoms to all the possible causes.

Note: Asterisk indicates editor's italics.

(liability, continued)

"One must not forget that the average jury today is very carefully picked over by the plaintiff's attorney, and rarely do they allow anyone that is knowledgeable of technical or practical matters to sit on the jury. The jurors that they will invariably pick are the ones that are low on the economic scale and who seem to feel that all large corporations are fair game."

As an example, Goodman told of a railroad boxcar repaired in mid-Pennsylvania by welding of the frame. When the welding was finished, the car was sent empty about 1000 miles, to Iowa, to pick up a load of starch. The full load was then routed back another 1000 miles to a box-making concern. The load of starch was pulled inside the box manufacturer's plant, and within a day or two, fire broke out inside the boxcar. The plant was totally destroyed.

The box maker contended that the frame had not cooled enough after the welding; that it had, in fact, retained heat that ignited the starch. This, after the boxcar had traveled over 2000 miles in several days.

The jury awarded the box manufacturer \$13.5 million.

Typical Design Review Check List (From Westinghouse)

1. Does the design *specification* include all customer requirements?
2. Does the design meet all functional requirements?
 - a. Are maximum stresses within limits through full range of travel, load, voltage, etc.?
 - b. Is derating utilized, wherever possible, to increase reliability?
 - c. Does design represent optimum in simplicity?
 - d. Have failure modes of critical elements been considered?
 - e. Are proper locking devices utilized?
3. Is the design satisfactory for all environmental conditions?
 - a. Temperature (operating, transportation, and storage)?
 - b. Humidity (operating, transportation, and storage)?
 - c. Vibration (operating and transportation)?
 - d. Shock (operating and transportation)?
 - e. Corrosive ambients (salt air, sea water, acids, etc.)?
 - f. Foreign materials (dirt, oil, sand, grit, etc.)?
 - g. Immersion (water, oil, etc.)?
 - h. Pressure and/or vacuum?
 - i. Magnetic fields?
 - j. Sound ambients?
 - k. Weather?
 - l. Radio interference?
 - m. Nuclear radiation?
4. Has available data on similar designs been reviewed, including:
 - a. Factory test malfunction reports?
 - b. Field service trouble and failure reports?
 - c. Customer complaints?
5. Have standard, time-tried parts been used wherever possible?
6. Are drawing and specification tolerances achievable in production?
7. Does the design minimize installation problems?
8. Does the design minimize maintenance problems?
9. Has a thorough value engineering or MATS analysis been made?
10. Have all provisions for personnel safety been included?
11. Has a study of product appearance been made?

Gains are made in bubble-memory development

Although bubble memories, announced by Bell Telephone Laboratories last September, are in no position to compete with semiconductor or core memories, significant gains in their development have been reported by James W. Nielsen, supervisor of Bell Lab's Optical and Magnetic Materials Group. He spoke at the conference on Preparation and Properties of Electronic and Magnetic Materials for Computers held this month in New York City and sponsored by the American Institute of Metallurgical Engineers.

According to Nielsen, the orthoferrite materials originally used are highly temperature-sensitive and are also difficult to grow as single crystals. Early this year, Bell Labs scientists discovered certain rare earth magnetic garnets

(such as europium-ebrum-aluminum-iron-garnet) that have the required property of uniaxial anisotropy. This group, said Nielsen, is not temperature sensitive and has the right bubble size (about 0.3 mil in diameter). With bubbles of this size, memories can be made with a storage density of 1-million bits per square inch.

In a motion picture film, Nielsen showed a circuit 30 mils square containing a 1000-bit shift register. Although he declined to predict a specific time, Nielsen told ELECTRONIC DESIGN that "it won't be very long before such shift registers are available."

One of the main problems facing Bell in developing methods of growing the material, he said, is that the thickness of a film of bubble memory must approximate-

ly equal the diameter of the bubble. Thus it is extremely difficult to prepare memories by slicing and polishing. The obvious solution is to lay down a film on a substrate. Three techniques for doing this are being studied at Bell Labs:

- Chemical vapor deposition—where volatile species of the metals in the garnet are vaporized and then oxidized onto a substrate.

- Liquid-phase epitaxy—where all components are placed into solution. This solution is tipped onto a substrate, cooled, and tipped back—leaving a thin film on the substrate.

- Sputtering—where the oxide is used as an electrode and is bombarded in an rf field.

Nielsen believes that the chemical vaporization technique holds the most promise. ■■

Tell us the Truth.

Okay, Signetics, they tell me you're prepared to custom-build ROM for all kinds of applications. To tell the truth, here's my ROM application:

- Control
- Micro-programming
- ASCII-ebcdic
- Hollerith to EXCESS-3
- Binary to BCD
- Adder
- Function generator
- Character generator
- Other: _____
- _____
- _____
- _____
- _____
- _____
- _____

Now you tell me the truth, and nothing but, in your data sheets and truth table forms. While you're at it, send details of your off-the-shelf ROM 8224 (ASCII-ebcdic) a TTL 256-bit IC organized as 32 words with 8 bits per word. One more thing: this is my real

name _____
company _____
address _____
city _____
state _____ zip _____

Mail to: Mr. Stan Goodrich, Signetics Corporation, 811 E. Arques Ave., Sunnyvale, Ca. 94086.

Signetics 

Signetics Corporation / 811 E. Arques Ave., Sunnyvale, California 94086 / A subsidiary of Corning Glass Works

INFORMATION RETRIEVAL NUMBER 21

Bell's goal: A telephone revolution in 1970s

Harried by overloads, telephone utility is looking to new technology to increase capacity fourfold

Milton J. Lowenstein
Technical Editor

A revolution in telephone transmission appears in the making in the 1970s. After years of reliance on coaxial cable and microwave links, the Bell System is turning seriously to new technology.

In an address in New York City, William M. Ellinghaus, president of the New York Telephone Co., said that Bell planned to increase its capacity fourfold through satellite, millimeterwave and laser communications. Both voice and data capabilities are scheduled to be expanded.

Already underground waveguides are projected for the latter part of the decade. And, just recently, Bell Telephone Laboratories announced that a newly developed semiconductor laser showed high promise for ultimate application in the first practical laser communications system.

"This is the laser we have been waiting for," Rudolph Kompfner, associate director of communications research at Bell Laboratories, said enthusiastically at a press conference last month.

The laser, described by Bell scientists at a conference sponsored

by the American Society of Metallurgical Engineers, is smaller than a grain of sand. It is the first to operate continuously at room temperature. Problems in adapting the device for communications remain, but Bell is hopeful that they will be solved and that the laser will prove to be the key to a long-haul system capable of carrying millions of telephone channels simultaneously. The laser itself isn't expected to cost more than \$1 a unit once fully developed.

Ellinghaus, who outlined the Bell System's expansion plans in a paper given at the 1970 convention of the Association for Computing Machinery, cited improved microwave capacity as an example of progress to date. Microwave communication links have doubled in the last five years, he noted, with increasing stress on solid-state devices and broader bandwidths.

A trend toward digital

Another trend, he said, will be toward less analog transmission and more digital of both voice and data. The reason for this is that digital transmission is more efficient for voice and more adaptable for data.

In response to the growing demand for data communications, a digital network linking 60 major cities will be ready by 1975, Ellinghaus said. It will include microwave links and coaxial cable and will operate in every speed range. Error rates are projected at less than one in 10^7 . In the meantime automatic switched networks (as opposed to private lines) will soon be upgraded to accommodate data rates of 4800 bits/s.

At the same convention John K. Lady, director of research for the National Cable Television Association, spoke for one of Bell's possible competitors. He pointed out that CATV could easily carry data communications.

"A high-speed printer requires a 12 kbit/s channel," he said. Com-

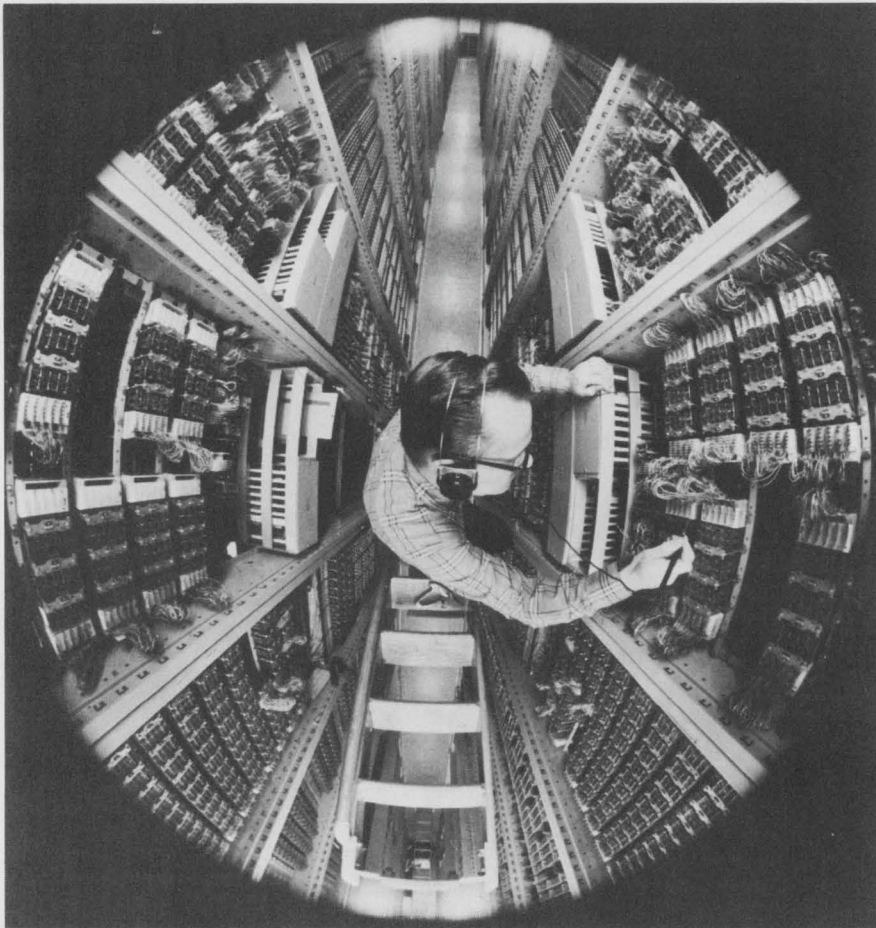

New switching equipment has been installed in New York City's financial district to handle greatly increased traffic. Every second, 85 telephone calls pour into this office and the trend is upward.

mon carriers cannot now support this rate, but a cable can now provide 200 such data channels per TV channel.

"Future capabilities include 13,000 such channels per TV channel, if both time-division and frequency multiplexing are used."

The need for expanded telephone capacity has been underscored dramatically in New York City. A report by the Federal Communications Commission has indicated that New York has the worst telephone service in the country. Traffic is so heavy that the present switching system can't handle it all in peak hours. Amid rising consumer complaints, the New York City Dept. of Consumer Affairs has told telephone subscribers not to pay their bills if service isn't meeting their needs.

Nor is this situation confined strictly to New York. Lewis C.

Clapp, president of Dial Data, Inc., of Englewood, N.J., envisions a national telephone traffic crisis by 1972 "unless drastic and dramatic measures are taken to improve the situation." Clapp says his company decided not to locate in Manhattan because he was "advised confidentially by people within the phone company that a serious overload problem was developing."

While the Bell System has said that data communications presently constitutes only a small percentage of telephone revenue, it is an area of service that is growing rapidly. By 1975 more than 70% of all computers will involve time-sharing systems, according to the Stanford Research Institute and the Arthur D. Little Co. If this happens, it will tax the already burdened telephone system still more.

To help alleviate present over-

loads, Bell is pushing mass production of ESS—the Electronic Switching System—first conceived of at Bell Laboratories in the early 1960s. ESS units are being turned out at Western Electric's huge factory in Hawthorne, Ill., near Chicago.

ESS is an improvement, but it's doubtful if it can solve the overload problem completely. A number of ESS offices have already been installed in New York, but during periods of heaviest traffic, some of these offices have been snarled for as long as 20 minutes.

Bell Telephone Laboratories, with headquarters in Murray Hill, N. J., has come up with many innovations to speed telephone service, but eventually it is up to the individual telephone companies and AT&T to plan the successful implementation of such developments. ■■

A laser that may change communications

John N. Kessler
News Editor

The key to a huge-capacity telephone communication system may rest with a tiny semiconductor laser so simple, rugged and efficient that Bell Laboratories executives are confident that it can be readily developed for use. Made of aluminum-gallium-arsenide and gallium-arsenide by two Bell scientists, Morton B. Panish and Izuo Hayashi, the device was described by the inventors at a recent con-

ference in New York sponsored by the American Society of Metallurgical Engineers.

Previously semiconductor lasers operated with short pulses of electricity. Because the amount of current required for lasing was relatively high, the laser could not be operated continuously at room temperature. As a result only a fraction of the laser's vast message-carrying capacity could be used. But by using what Panish and Hayashi refer to as a "double

heterostructure," the active region is confined to a strip 20 millionths of an inch thick, and this increases the number of hole-electron recombinations essential for lasing.

The new laser consists of four layers: two each of GaAs and AlGaAs. When a forward bias is applied across the p-n junction of the laser, infrared light is emitted at about 8500 Å.

Current thresholds are as low as 2700 amperes/cm². When the laser is operated at 30% above this threshold, output power at room temperature is about 20 mw, with a power efficiency of about 2%. In experimental structures, room temperature thresholds as low as 1000 amperes/cm² have been reported by Bell Laboratories.

The biggest remaining problem in developing a laser communication system is the transmission medium. Laser light is readily attenuated by the atmosphere, especially in rainy or snowy conditions. But Bell researchers are looking into the use of underground pipes to confine the laser beam and the possible use of gas lenses and conventional and fiber optics to focus the beam and keep it centered in the pipe. ■■

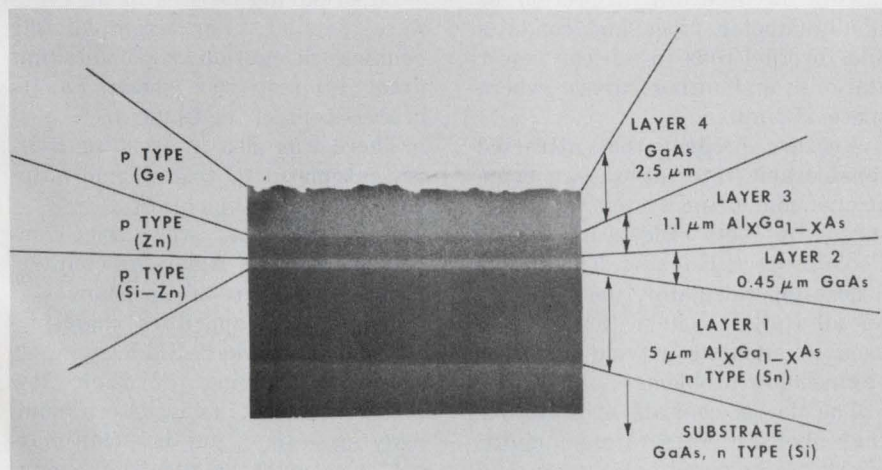

Double heterostructure for new semiconductor laser consists of four layers. The materials were prepared with liquid phase epitaxy.

Sonar research put to work in urban sewage system

Fallout from Navy sonar work has resulted in an acoustic flowmeter that will measure the velocity of waste water that flows from Washington, D. C., to a water-pollution plant outside the city.

Developed by the Westinghouse Ocean Research and Engineering Center near Annapolis, Md., the system measures fluid velocity with an accuracy of $\pm 1\%$.

The changes in sound velocity caused by differences in salinity, fluid temperature and other properties are automatically corrected. Temperature, for example, is continually read, and its effect on signal speed is compensated for in the final reading.

The device measures flow by comparing sound velocities of signals transmitted by two ultrasonic transducers to two hydrophone receivers. One transmitter sends its signals upstream at a 45-degree angle to the flow, the other transmits downstream. The signals downstream are carried along by the flow and arrive at the receiver faster than they would in still water. The ones fighting the upstream current take longer. The difference in time between the two reveals the velocity of the flow itself.

The transducers and hydrophones are mounted on the sides of the pipe so that they won't obstruct the flow. ■■



Ultrasonic transducers, held by S. G. Fisher, manager of sonar and flowmeter programs for Westinghouse, will measure waste-water flow in Washington, D. C.

Foreigners seek U.S. market despite recession

The U. S. electronics market may be feeling the pinch of a down year, but by European or Australian standards, it is a good year. As one Englishman put it:

"We're amazed at the buoyancy of your market during a 'recession.' The amount of business in Los Angeles during an off year is greater than that of the whole United Kingdom during good times."

He commented, however, that the British government delegation at Wescon had received a number of inquiries about job opportunities in England.

Despite the economic downturn, there were more European and Australian exhibitors at Wescon this year than ever before: 28 British companies, compared with 21 last year; a Finnish Government delegation represented eight companies for the first time; and 13 Australian companies were there, compared with none last year.

Japanese exhibitors were down (20 compared with 30 last year), but the numbers of individual Japanese attending the show were considerably larger. Last year around 500 attended; this year there were at least 1000. Some European exhibitors said that

about 15% of their inquiries came from the Japanese.

Foreign products that attracted the most attention fell into three categories:

- Those that were in some way unique.
- Those that saved labor costs.
- Those that were less expensive or of better quality than their U. S. counterparts.

A unique product shown was a British miniature closed-circuit TV camera, distributed through MTI Div. of KMS Industries, Inc., Anaheim, Calif. The 1.5-inch-diameter camera is used for inspection of small-diameter pipes and conduits and for fuel rods in nuclear power stations and other areas where space is limited.

Another product that attracted considerable interest was an operational computing system manufactured by Ceta Electronics Ltd., Poole, Dorset, England. The size of a desk-top calculator, the device is an all-digital system that can be used to simulate a wide range of engineering problems.

The device consists of a console that houses integrators, multipliers, sample-and-hold units and function generators, connected to do a particular simulation. Prob-

lem parameters, such as initial conditions, time constants, and attenuation factors, may be keyed into any unit by selecting its address and setting the desired value. Outputs from the units can be continuously monitored on a CRT display.

According to Philip Cooke, managing director of the company, the all-digital system is more accurate than a combination analog-digital system. Its accuracy is one part in 10^8 , he said, compared to one part in 10^3 , for an analog computer. It is just as fast as an analog computer, he said, and less expensive.

Labor-saving devices of all types were popular. For example, the Finnish delegation reported that great interest was shown in its process-control equipment.

There was also interest in British automatic IC testers and automated bonding machines.

Anything that was price-competitive with its American counterpart was popular at the show.

Australian capacitors manufactured by Hawker Siddeley were successful because of their low price for short runs. As a company spokesman put it, "Our market is so much smaller than yours that what you consider a short-run special is standard for us." ■■



*“If you’re calling Radiation
and **Harris**
answers...*

Don’t hang up!”



RADIATION MICROELECTRONICS HAS CHANGED ITS NAME TO **HARRIS SEMICONDUCTOR**

INFORMATION RETRIEVAL NUMBER 22

NEW PLANT:



HARRIS SEMICONDUCTOR . . . a new name and a new IC manufacturing facility with approximately 113,000 sq. ft. of the latest innovations in wafer manufacturing and development.

HARRIS SEMICONDUCTOR, the new name for Radiation Microelectronics, is just in time for the opening of one of the most up-to-date IC manufacturing facilities in the country. Smooth production flow and exacting quality control have been the keynote of its design. To assure environmental integrity there are four completely

isolated modules right in the heart of the building: two for wafer manufacturing and inspection . . . one for engineering development and assembly . . . and the fourth for photo-masking and process development. Each has its own vertical laminar-flow ventilation system which blankets the entire module with super-clean air kept at $72^{\circ} \pm 1^{\circ}\text{F}$ and $45\% \pm 1\%$ rela-

tive humidity. And as added environmental protection, the air is filtered again by the laminar-flow hoods at each individual production station. That assures us of maximum yield for our high-quality chips. And it assures Harris Semiconductor customers that they'll get IC's with the *best price/performance ratio on the market.*



SUPER-CLEAN AIR . . . In vertical laminar-flow hoods designed to provide additional air filtering, wafer photo resist is exposed to ultraviolet light after precise mask alignment.

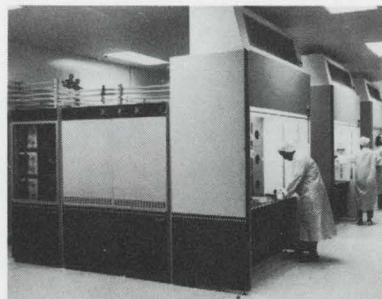

THE LATEST DIFFUSION EQUIPMENT
Six furnace chambers on each of these Brute diffusion systems are regulated within 0.25°C for precise uniformity of wafer diffusion rates.

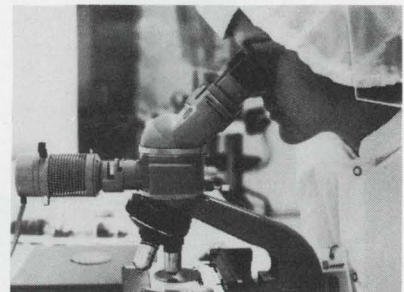

All material moving through the manufacturing process is continually monitored to assure conformance to the rigid standards of high quality Harris Semiconductor has been noted for.

NEW PRODUCTS

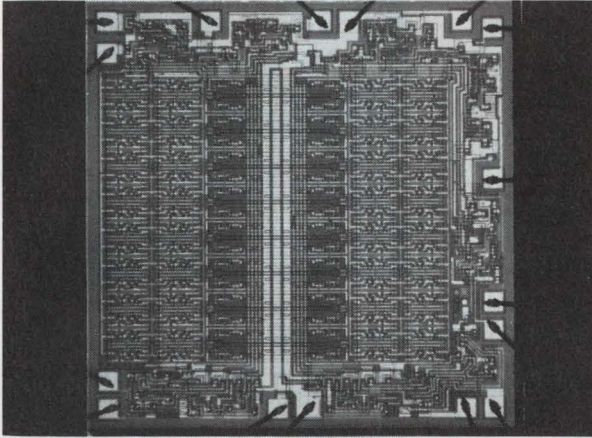

64-BIT BIPOLAR RAM WITH 35ns ACCESS

Using Schottky clamped transistors the Harris RAM-0064 is the first bipolar read/write memory capable of 35ns access times. As a high-speed scratch-pad memory, it provides:

- DTL/TTL compatibility
- Full decoding to 16 words by 4 bits per word
- Uses single 5 volt power supply
- Open collector output for "Wired-Or" expansion
- 16 pin dual in-line package
- 0° to +75°C, \$25.60*
- -55° to +125°C, \$32.00*

*100 to 999 unit price

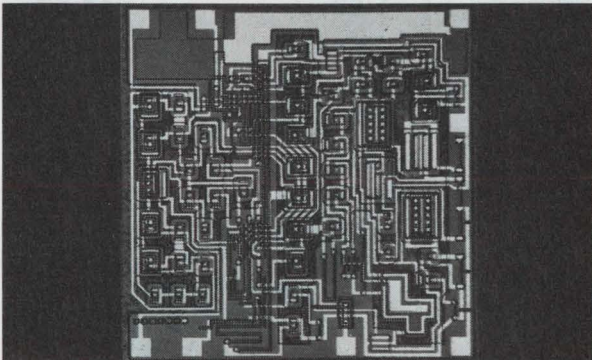

NEW WIDE-BAND, HIGH-IMPEDANCE OP AMP

Harris' new RA-2620 and RA-2625 Wide Band Op Amps have gain bandwidths which are an order of magnitude better than standard op amps on the market today. In addition, they provide:

- Input impedance of 500Megohms
- Slew rate of 35 V/us
- Typical bias and offset currents of 2nA
- Ideal for high-input impedance comparators
- RA-2620 . . . -55° to +125°C, \$17.85*
- RA-2625 . . . 0° to +75°C, \$10.70*

*100 to 999 unit price

And in addition to our recently introduced PROM and 8-bit D/A Converter, watch for these new products soon to be announced:

MEMORIES

256 x 1 PROM
1024 BIPOLAR ROM
16 BIT BIPOLAR RAM
2560 MOS ROM

DIGITAL

9300 STORAGE REGISTER
9301 1/10 DECODER
9304 DUAL ADDER
9309 DUAL 4 INPUT MPX
9312 SINGLE 8 INPUT MPX
9316 HEX COUNTER

LINEAR

6-BIT CURRENT SOURCE
MONOLITHIC LADDER
NETWORKS

IF
HARRIS
answers
DON'T
HANG
UP!



HARRIS SEMICONDUCTOR

A DIVISION OF HARRIS-INTERTYPE CORPORATION

Norwalk, Connecticut (203) 853-3646

Lexington, Massachusetts (617) 862-1055 / Frederick, Maryland (301) 662-5400 / Oaklawn, Illinois (312) 423-6010 / Albuquerque, New Mexico (505) 268-3549 / Palo Alto, California (415) 321-2280 / Dallas, Texas (214) 231-9031 / Long Beach, California (213) 426-7687 / P. O. Box 37, Melbourne, Florida 32901 (305) 727-5430 / EXPORT SALES, DAGE CORPORATION, STAMFORD, CONNECTICUT

RADIATION MICROELECTRONICS HAS CHANGED ITS NAME TO HARRIS SEMICONDUCTOR

INFORMATION RETRIEVAL NUMBER 23

Technology Abroad

A superconductor passing high dc or ac currents at a temperature approaching absolute zero has been developed by engineers of the Moscow Institute of Ferrous Metallurgy. The new material is a combination of several metals and alloys pressed into a monolithic system. Each square centimeter can conduct up to 100,000 A. Superconductors of this type have already been tested in certain Cosmos earth satellites, and Soviet scientists say they believe they'll soon be making superconductors that can be used at room temperature.

The successful use of pulse-code modulation (PCM) on cables up to 25 miles between telephone exchanges has the British Post Office seeking to apply digital transmission on a wider scale. Under plans to provide for trunk traffic that doubles every seven years, the post office has commissioned GEC-AEI and Plessey Telecommunications Research to carry out studies for a digital transmission system with an information rate of about 120 megabits per second. This study will cover transmission, multiplexing equipment and analog-to-digital converters for services including voice channels derived from the basic PCM multiplexes, color TV, Viewphone, and data transmission. These field studies are intended to pave the way for digital transmission systems to be linked into long-distance networks at the end of this decade.

A new fiber-optics fabrication technique for producing cascade image-intensifier lenses is in production at a new \$24-million Mullard plant at Mitcham, Surrey, England. Glass billets are first drawn to a 4-mm-diameter fiber, through a borosilicate glass tube. The fibers emerge from the drawing system with a rectangular chamfer cut into one side. They are then cut into lengths and stacked 14 x 14 with the chamfers

facing each other, thus forming rectangles. Opaque glass rods are then inserted into the vacancies. The fibers are repeatedly stacked and redrawn, then placed in an evacuated glass envelope and hot-pressed at pressures up to 10,000 psi. The resulting block—containing hundreds of thousands of clear fibers bounded by opaque glass—is cut transversely and prepared for phosphor coating.

Finnish Railways recently inaugurated its largest control system for rail routing at Riihimaeki, 43 miles north of Helsinki. The station's entire passenger traffic, plus a large portion of its freight movements, are controlled by a pushbutton system manufactured by Siemens of Germany. The station track layout is displayed on two independent luminous track diagram panels. The system can set up more than 100 direct train routes and more than 200 shunting routes.

Powerless illumination for instrument and control panels was displayed recently at Britain's Farnborough Air Show. The system, devised by Saunders-Roe Developments Ltd., uses small, sealed glass tubes coated internally with a phosphor and filled with tritium gas. Tritium, a radioactive isotope of hydrogen, emits low-energy beta particles that strike the phosphor and produce light. The tubes—called Beta-lights—are inserted in a 3/8-inch-thick panel.

A fail-safe assembly method suitable for hand-assembled equipment with a number of variables has been developed by Sodeco, a Geneva, Switzerland, manufacturer of electronic counters. The assembler's job is simplified by the use of a punched-card control unit that activates signal lamps situated on component trays. The assembly sequence is dictated by the lamps so that the operator does not have to rely on memory or refer to charts. Up to 60 different component containers can be housed on the assembler's U-shaped workbench, and a special punched card is produced for each version of the product.

SCHAUER

1%

tolerance

1 WATT ZENERS ARE A REAL BUY!

ANY voltage from 2.0 to 16.0 at the industry's LOWEST PRICES!

Quantity	Price each
1-99	\$1.07
100-499	.97
500-999	.91
1000-4999	.86
5000 up	.82



THE HI-RELIABLE!

No fragile nail heads.

Silicon junction aligned between two, parallel, offset tantalum heat sinks . . . great lead tension strength.

All welded and brazed assembly.

High pressure molded package.

Gold plated nickel-clad copper leads.

Write or phone for Form 68-4 for complete rating data and other tolerance prices.

Semiconductor Division

SCHAUER MANUFACTURING CORP.

4511 Alpine Avenue
Cincinnati, O. 45242
Ph. (513) 791-3030

Washington Report

DON BYRNE, WASHINGTON BUREAU

F-15 arms money may be diverted for electronics

The Air Force has canceled plans to develop the Aim-32A fighter missile and reportedly plans to use a Navy missile, the Agile, in its place on the McDonnell Douglas jet. According to Air Force estimates, cancellation of the Aim-32A would save approximately \$200-million in R&D funds during the early 1970s. It may be possible, Air Force sources say, to shift these funds to the development of the radar and electronic systems of the F-15. Under the sliding-scale development plan for the F-15, several electronic packages of varying sophistication and cost could be used in the new fighter. A key element in the F-15's electronic package is a multi-mode search and track radar that can shift operating frequency constantly.

More layoffs in aerospace industry

The grim employment picture in the aerospace industry has been darkened further as a result of NASA's decision to cut two moon landings from the Apollo program. NASA estimates the move will cut 700 employees from its own payroll and 18,000 over the next two years from that of its contractors. As the program stands now, there will be four more moon landings and then the launching of the Skylab orbital workshop in November, 1972. Besides the three Skylab missions, running through 1973, there will be little or no activity in manned space flight for at least three to five years until the space shuttle flies. About the only bright note in NASA's cutback in Apollo flights was the announcement that McDonnell Douglas would receive \$97.1-million more to cover the cost of storage and testing Saturn V boosters and maintenance of ground-support equipment.

SST battle delaying transportation budget

Controversy over whether to continue or scrap the nation's SST program has held up Senate consideration of the Dept. of Transportation's \$6.65-billion budget request until now. At press time, a vote on the Senate floor was scheduled for Sept. 28. The request was stalled in Appropriations Committee because \$294-million of the proposed budget is for continuing work on the supersonic transport and neither the pro nor the con forces on the SST issue was sure that they had sufficient strength to survive a showdown. Therefore each side was reluctant to send the budget bill to the Senate floor for a vote.

Should the Senate defeat the bid for SST funds, there is little likelihood that the House would be able to muster sufficient strength to force the Senate to reconsider. Opposition to the SST is now centering on its possible damage to the ecology and on "national priorities." In an election year "national priorities" is a key word to office-seekers. Ironically the two key backers of the SST—Senators Warren Magnuson and Henry

Jackson from the state of Washington—are finding their report somewhat of a political albatross.

Jackson is an avowed conservationist and Magnuson has been in the forefront of consumer protection legislation for years.

The Federal Aviation Administration, meanwhile, says that should the money bill fail to win approval, work on the SST will continue anyway—though at a reduced rate—because there are still some unobligated funds around. Presumably the FAA would wait for a more auspicious time to submit a new request for SST funds.

Ex-Collins executive nominated for U. S. post

Dr. George F. Mansur, formerly director of the Space Systems Div. at Collins Radio, has been nominated by the President for the job of deputy director of the Office of Telecommunications Policy. He has been serving as a consultant to the federal offices. While with Collins he directed the company's work on the Apollo program for NASA and worked on the Terrier ship-to-air missile program, advanced proximity fusing and the Polaris navigational system. He has also served as director of the Navy's high-capacity data communications network.

AT&T asks for a sixth Atlantic cable

The American Telephone and Telegraph Co. has asked the Federal Communications Commission for authority to build a sixth trans-Atlantic cable, citing a pressing need for 825 voice-grade circuits. In applying for the authority, AT&T asked the FCC not to await the outcome of its current inquiry into the future of international communications. Unless a cable is built, the communications company said, there will be an imbalance between satellite and terrestrial communications. The request is expected to evoke protest from the Communications Satellite Corp. In its filing AT&T said it would like the \$86-million cable to be in operation by 1972. Otherwise, it said, the ratio of circuits by then will be 71% satellite and 29% cable. The cable would run from Rhode Island to France, where it would connect via ground facilities with Germany and via satellite with the Indian Ocean area.

Capital Capsules: Neither industry nor NASA sources look for sweeping changes in contractual procedures, despite the re-awarding of a \$50-million satellite contract to Fairchild-Hiller after it had been awarded to General Electric. . . . Sen. Mike Gravel (D-Alaska) reports that at least two Federal Communication Commission members say they favor a further review of commission action that set satellite ground-station application fees at a blanket \$50,000. Chairman Dean Burch is reported to favor some provision for small receive-only ground stations, such as might be used in Alaska. . . . NASA expects to hire some 75 Government and contractor personnel in a new Earth Resources Program activity at its Mississippi test facility in Hancock County. Employment is expected to hit 185 in three years in such fields as physics, instrumentation engineering, data-handling and cartography. Data will be fed from Earth Resources Technology satellites and the manned orbiting Skylab, both scheduled for launching in 1972.

Introducing the thin-film thermistor you would've designed if you designed thin-film thermistors.



First, off, you'd probably design a thin-film thermistor as small as possible. That's how we designed ours. Smaller than anything else on the market.

Secondly, you'd make it very, very stable. We did. And we did it by sealing it in glass. Nobody else does this.

Thirdly, you'd give it a faster response time. Of course you would. With today's increased reaction rates, you need as short a response time as possible. It's certainly one of the features of our thermistor.

And lastly, like us, you'd cut the price by 40%. The heck you would. You'd probably charge a fortune for a thermistor this good. And get away with it too. Well, three out of four isn't bad.

If you'd like further information on the thin-film thermistor designed your way, write us. Ceramic Magnetics, Inc. Micromag Division, 87 Fairfield Road, Fairfield, New Jersey 07006.

CeramicMagnetics 

SIDELIGHTS

The evolution of a cover picture

When Art Director Cliff Gardiner sat down with Milt Lowenstein, technical editor, to discuss the cover picture for Milt's article on generating functions from discrete data (p. 42) all they had to start with was a diagram of a three-dimensional surface. They had no idea that the end result would involve the enthusiastic help of people from several parts of New York City.

In the first place, Cliff decided to construct a model of the drawing—in wood because he likes to work in that medium. He decided to use 1/4-inch-diameter 9-inch dowels—324 of them—to be inserted at the proper depth in a wood panel. He bought the dowels at a hardware store. Passing a cabinetmaker's shop, he stopped in, and the owner not only sold him the proper wood for the panel—a fine grain of plywood—but spent an hour teaching him tricks of the trade.

Cliff's next stop was at a Czech cabinetmaker's, where he rented power tools to drill holes for his dowels. And then the dowels wouldn't go in the panel! So he picked out a third cabinetmaker at random from the Yellow Pages of the Manhattan phone book, and asked for some advice. During the discussion, it came out that Cliff was young. The cabinetmaker then invited him down to use a drill, free of charge . . . "It's so nice to have a young person seek advice."

The model was now complete, and it proved the fallacy of "cold" New Yorkers: give a man a problem and he can get it done—if he just asks questions.

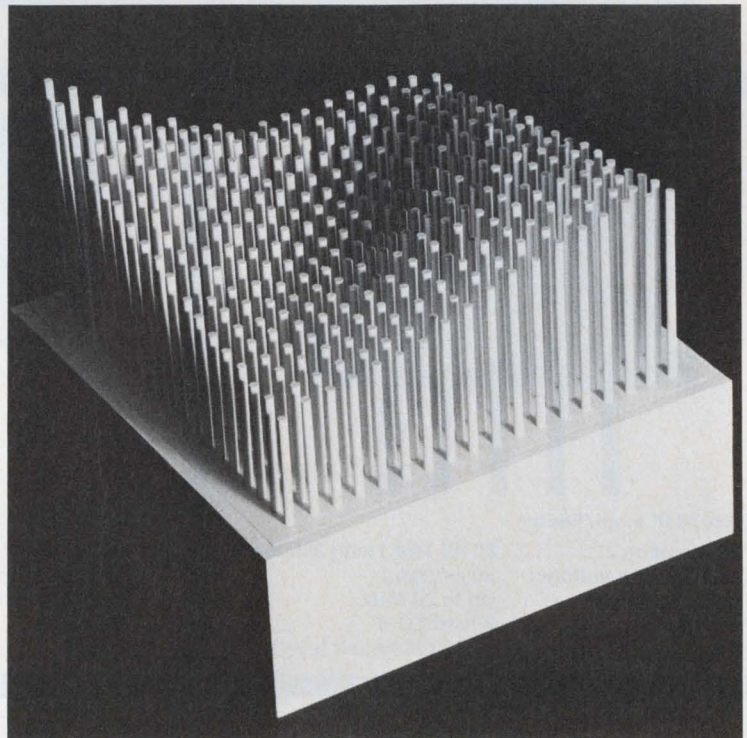

Model of a three-dimensional surface, devised by Art Director Cliff Gardiner to illustrate Milt Lowenstein's cover article.

Design breakthrough in FM-IF systems: two new RCA IC's for more performance, with fewer components

Two new RCA Linear IC's now offer you a brand new approach to FM-IF system economy and performance. The CA3076 (high-gain IF amplifier/limiter) and the CA3075 (IF amplifier, limiter, FM detector, and audio preamplifier) have been designed to bring you an IF system with dramatic reductions in external components. And—to make the total economics of your system attractive—RCA has priced the CA3076 at \$1.60 (1,000-unit level) and the CA3075 at \$1.40 (1,000-unit level).

For your applications in communications receivers and high-fidelity equip-

ment, with FM IF's requiring bandwidths to 20 MHz, here are some highlights on these two new RCA types:

The CA3076 has an input limiting voltage (knee) of $50 \mu\text{V}$ (typ.) and 80 dB (typ.) gain with 2-kilohm load at 10.7 MHz. It contains an integral voltage regulator, for operation at power supply voltages from 6 V to 15 V.

The CA3075 limits with an input voltage of $250 \mu\text{V}$ (typ.) at 10.7 MHz. It has low harmonic distortion and excellent AM rejection—55 dB (typ.) at 10.7 MHz. Differential peak detection permits single-

coil tuning. The CA3075 incorporates an audio preamplifier with 21 dB (typ.) voltage gain, and an integral voltage regulator, for operation at power supply voltages from 8.5 V to 12.5 V.

For further information, see your local RCA Representative or your RCA Distributor, or write: RCA, Commercial Engineering, Section 571-27/CA42, Harrison, N.J. 07029. International: RCA, 2-4 rue du Lièvre, 1227 Geneva, Switzerland, or P.O. Box 112, Hong Kong.

All components required for a typical IF strip are shown in this illustration.

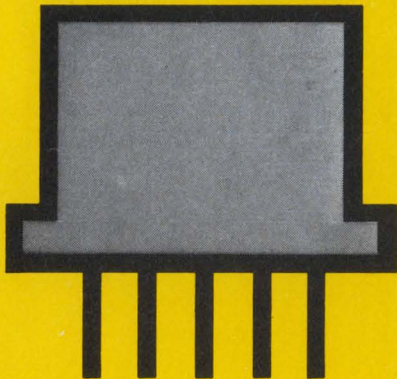
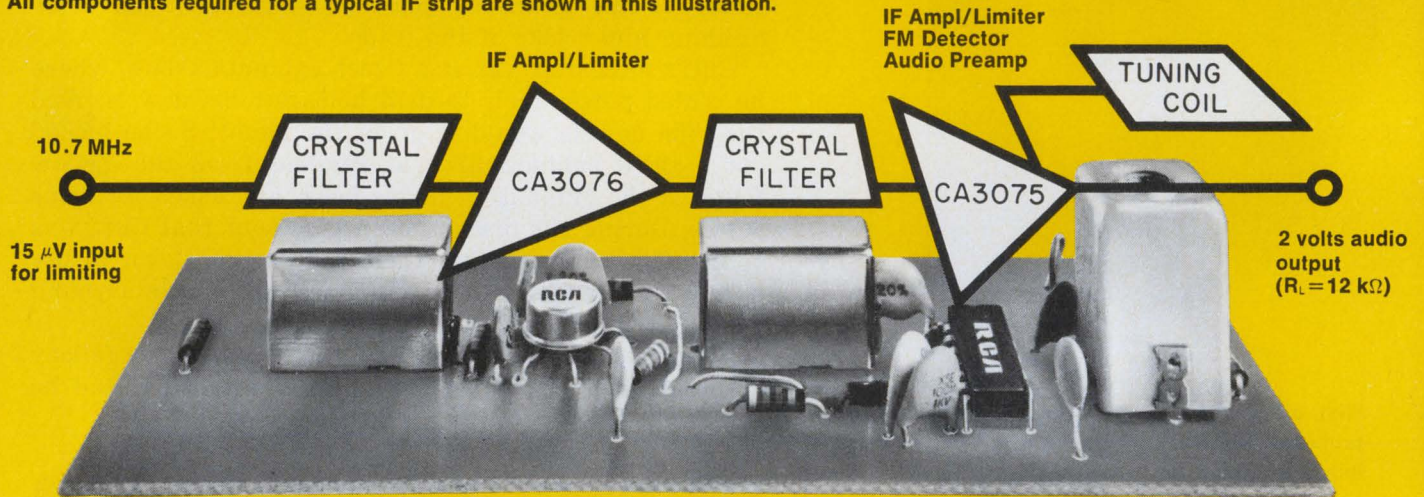

CA3076 IF ampl/limiter

Voltage gain: 80 dB (typ.) with 2k Ω load
 Input limiting voltage: .. 50 μV (typ.)
 Freq. capability: Up to 20 MHz
 Package: 8-lead TO-5
 Price: \$1.60 (1000-unit level)

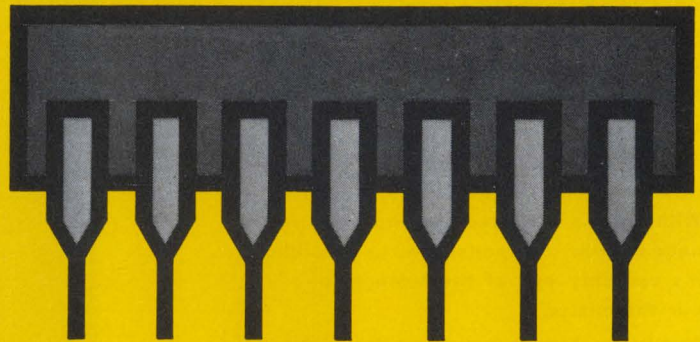

CA3075 IF ampl/limiter, peak detector, and audio preamp

Voltage gain (audio preamp): 21 dB (typ.)
 Input limiting voltage: 250 μV (typ.)
 Freq. capability: Up to 20 MHz
 Package: 14-lead DIP (formed leads)
 Price: \$1.40 (1000-unit level)

RCA
Integrated Circuits

Publisher

Hugh R. Roome

Editors

New York Office
850 Third Ave.
New York, N.Y., 10022
(212) 751-5530

Editor: Frank Egan
Managing Editor: Ralph Dobriner
Managing Editor: Raymond D. Speer
Microelectronics, Steven A. Erenburg
Computers, Milton J. Lowenstein
Microwaves, Michael J. Riezenman
Management, Richard L. Turmail
News, John N. Kessler
Military-Aerospace, John F. Mason
New Products, Roger Allan
New Products, Lucinda Mattera
Copy, Marion Allen

Field Offices

Massachusetts
Jim McDermott
P.O. Box 272
Easthampton, Mass. 01027
(413) 527-3632

San Francisco
Elizabeth de Atley
Suite 6, 95 Main St.
Los Gatos, Calif. 94022
(415) 941-3087

Los Angeles
David Kaye
2930 Imperial Highway
Inglewood, Calif. 90303
(213) 757-0183

Washington
Don Byrne
1425 N St. NW
Washington, D.C. 20005
(202) 667-6568

Editorial Production

Dollie S. Viebig
Richard D. Grissom

Art

Art Director, Clifford M. Gardner
Assistant, William Kelly
Rita Jendrzejewski
JoJo Miskimmon

Production

Manager, Thomas V. Sedita
Helen De Polo
Kathleen McConkey
Leslie Stein

Circulation

Manager, Nancy L. Merritt

Information Retrieval

Peggy Long

EDITORIAL



Let's tighten up those sloppy buying practices

We had a friend once whose wife's buying habits were just short of unbelievable. She was constantly buying things that she either couldn't use or that were far better than she actually needed.

Plastic dishes that melted in the dishwasher, a 9-by-12-foot carpet for a 9-by-10-foot room, and an industrial-grade floor buffer for polishing one tiny floor every few weeks—these were only some examples of her purchasing prowess.

Before laughing too hard at the poor girl's misdeeds, though, we would do well to evaluate objectively our own buying patterns—both at home and on the job. The results of such honest self-evaluation might be surprising to many engineers who consider themselves both practical and logical when it comes to buying things.

These engineers, we'd bet, are extremely careful when buying a lawn mower or a car, or having a new roof installed on their house. For example, they wouldn't buy a riding type of mower if their lawn was extremely small. And they'd make sure they spoke to at least three or four dealers before buying a new car. But these careful practices fall by the wayside when purchasing and specifying on the job.

At work, these same engineers will buy a deluxe instrument that has far greater accuracy or stability than is needed. Or they will specify a particular manufacturer's op amp or connector without really checking on whether a cheaper equivalent is available. In most cases they then rationalize these decisions on the basis of "future" requirements, or "safety" factor, or "reliability."

What it amounts to frequently though, is that these engineers are not as careful at spending the company's money as they are at spending their own.

"So what?" they may say. "Is someone any less a designer just because he doesn't wring the last bit of cost savings out of his designs?" We think he is. Designing something that works is only part of his job. The designer's full worth depends also on the economic feasibility of making and selling the item.

FRANK EGAN

Generate functions from discrete data.

Read-only memories and averaging interpolation techniques combine high accuracy and low cost.

Arbitrary functions of one or two variables are frequently required in many types of electronic equipment. Several techniques for their generation have been proposed, but the problems of accuracy and complexity have never been satisfactorily solved.¹⁻⁷ Here is a method that uses a read-only memory (ROM) to store discrete values of the function and time-averaging interpolation to construct straightline segments between the data points.

Hardware requirements for quite complicated functions are not large. For example, an 8-bit 16-by-16 segment, two-variable function generator requires only 10 digital ICs and one ROM. If analog output is desired, five ICs must be replaced by a digital-to-analog converter. In contrast, a similar device, using conventional interpolation, must perform four additions, eight subtractions, three multiplications and two divisions, and it also requires the ROM.

The ROM time-averaging function generators offer excellent repeatability and high operating speed. With a clock frequency of 1 MHz, a new output can be calculated every 16 μ s.

Functions of one or two independent variables can be handled. Functions of a single variable, of course, require smaller memories because there are fewer data points. Let's take a look at the analytic technique.

Single-variable algebra is simple

In the arbitrary function $Z = F(X)$ (Fig. 1), Z_i and Z_{i+1} are the values of the function at X_i and X_{i+1} . A value of Z at any point between Z_i and Z_{i+1} can be approximated, of course, by conventional interpolation. Thus,

$$Z = Z_i + \Delta X (Z_{i+1} - Z_i) / (X_{i+1} - X_i) \quad (1)$$

where $(Z_{i+1} - Z_i) / (X_{i+1} - X_i)$ is the slope of the approximated function and $X - X_i = \Delta X$.

But instead of conventional interpolation, Z_{i+1} can be time-averaged for a fraction of a period

$\Delta t_x / T$ and Z_i for the remainder of the period, $\overline{\Delta t_x} / T$ (Fig. 1). The output of this averaging circuit is:

$$Z = Z_i (\overline{\Delta t_x} / T) + Z_{i+1} (\Delta t_x / T) \quad (2)$$

where $\Delta t_x / T = (X - X_i) / (X_{i+1} - X_i)$ and $\overline{\Delta t_x} / T = (X_{i+1} - X) / (X_{i+1} - X_i)$.

Eq. 1 and Eq. 2 are the same as shown by making appropriate substitutions.

Two-variable algebra is more general

Functions of two variables are expressed as $Z = f(X, Y)$ and can be plotted as in three dimensions (Fig. 2) with X and Y as the independent variables and Z as the dependent variable.

To generate a function of two variables with linear segments, the X and Y coordinates are divided into m and n segments, respectively. Frequently $m = n$, and the (mn) sectors of the X - Y plane are squares.

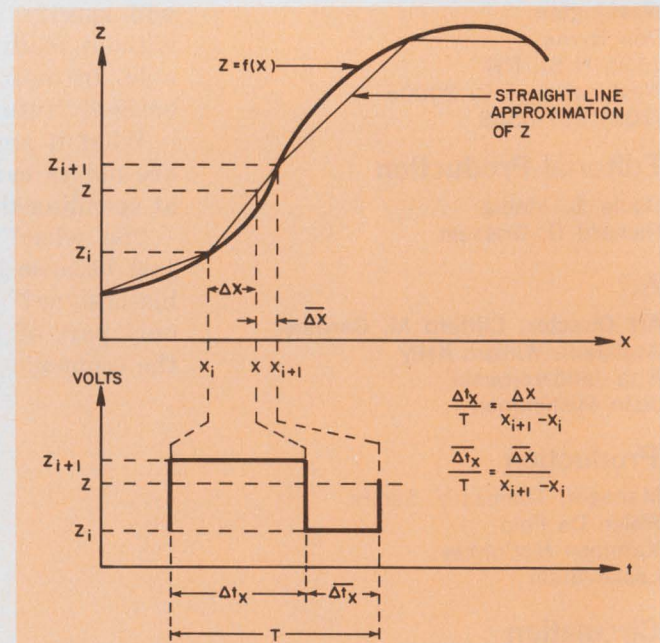

1. The approximate output, Z , is obtained by time-averaging Z_i and Z_{i+1} for intervals that are proportional to ΔX and Δx . The timing diagram (bottom) relates ΔX and Δx to Δt_x and Δt_x .

Hermann Schmid and David Busch, Avionics Control Dept., General Electric Co., Binghamton, N. Y.

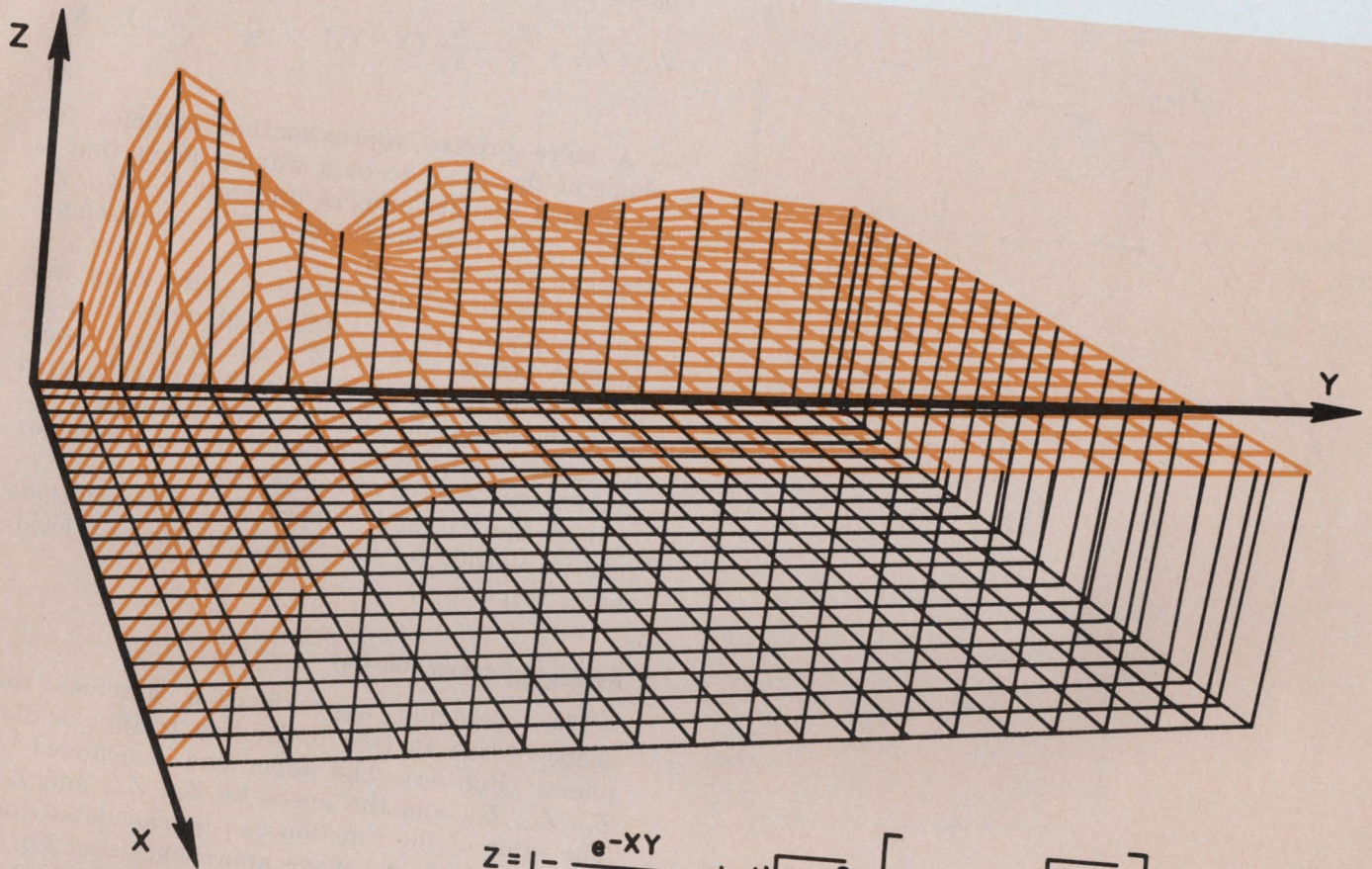

$$Z = 1 - \frac{e^{-XY}}{\sqrt{1-X^2}} \sin(\sqrt{1-X^2}) \left[Y + \tan^{-1} \frac{\sqrt{1-X^2}}{X} \right]$$

2. This three-dimensional surface is an approximation of the function of X and Y shown. The corner values of

each sector are stored in a ROM. Interpolation between these values is the basis of the function generator.

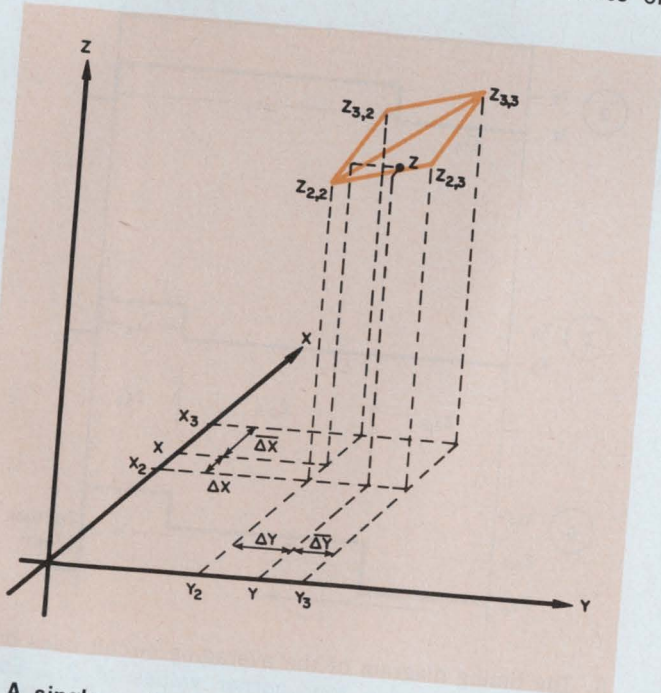

3. A single sector of the surface of Fig. 2 is drawn to show the relationships between the independent variables X and Y and the dependent variable Z, whose value is stored in the ROM.

The lines partitioning the X-Y plane in Fig. 3 are the segments $X_1, X_2 \dots X_m$ and $Y_1, Y_2 \dots Y_n$. Their intersections are the corners of the sectors and are identified as X_i, Y_j . At each intersection there is one value of the function, Z_{ij} , that must be known. A minimum of $(m+1)(n+1)$ values of Z_{ij} is needed to define $f(X,Y)$ if there are mn sectors. The problem of generating $f(X,Y)$ is that of storing the values Z_{ij} and of interpolating between them.

Consider the portion of the function located between X_2-X_3 and Y_2-Y_3 , as shown in Fig. 3. The four values of Z at the corners of this sector define a block with a square cross section. The height of this block at each of the four corners is Z_{22}, Z_{23}, Z_{32} and Z_{33} , and the shape assumed for the top surface determines the precision of the approximation.

The simplest approach assumes that the top surface is a flat plane (Fig. 4a). But this may give a poor fit because the four corners are not necessarily coplanar. Nevertheless, there are cases where the simple flat plane approximation is used. In these cases the function Z, for values

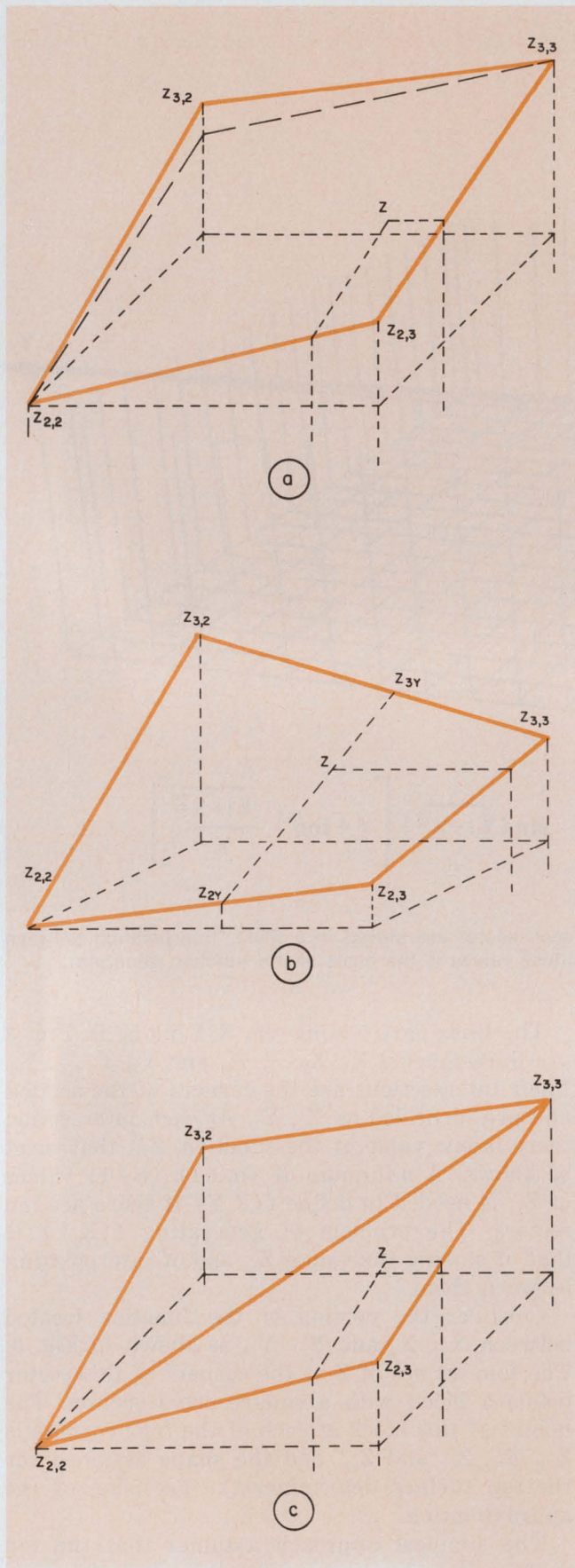

4. Several approximations to a curved surface are possible. A single flat plane (a) can intersect the curve at only three points and is a poor fit. A warped plane (b) is a better fit, as are two triangular flat planes (c). The latter method is used because the circuitry is simple.

of X and Y lying between $X_2 - Y_3$ and $Y_2 - Y_3$, is based on only three of the four corners. Thus,

$$Z = Z_{22} + \frac{Z_{23} - Z_{22}}{Y_3 - Y_2} (Y - Y_2) + \frac{Z_{33} - Z_{23}}{X_3 - X_2} (X - X_2) \quad (3)$$

A more precise approximation assumes the shape of the sector to be a warped plane that is so twisted that its corners intersect Z_{22} , Z_{23} , Z_{32} and Z_{33} of the original function. The sides remain straight lines (Fig. 4b).

The location of an arbitrary point Z on this warped plane can be established only if intermediate points such as Z_{2Y} and Z_{3Y} are determined first. The value of Z can then be calculated as in the single-variable function generator, but it results in an equation that requires a complex and expensive piece of equipment.

Both the flat and warped plane assumptions lead to difficulties—inaccuracy or complex hardware, respectively.

Averaging saves the day

The averaging approximation assumes the shape of the surface to be two triangular flat planes (Fig. 4c). The upper one is bounded by Z_{22} , Z_{32} , Z_{33} , and the lower by Z_{22} , Z_{23} , and Z_{33} . The value of the function can be calculated just as in the single flat-plane approach, using Eq. 3. The upper flat plane is used in the calculation if $\Delta X < \Delta Y$; the lower flat plane is used if $\Delta Y < \Delta X$.

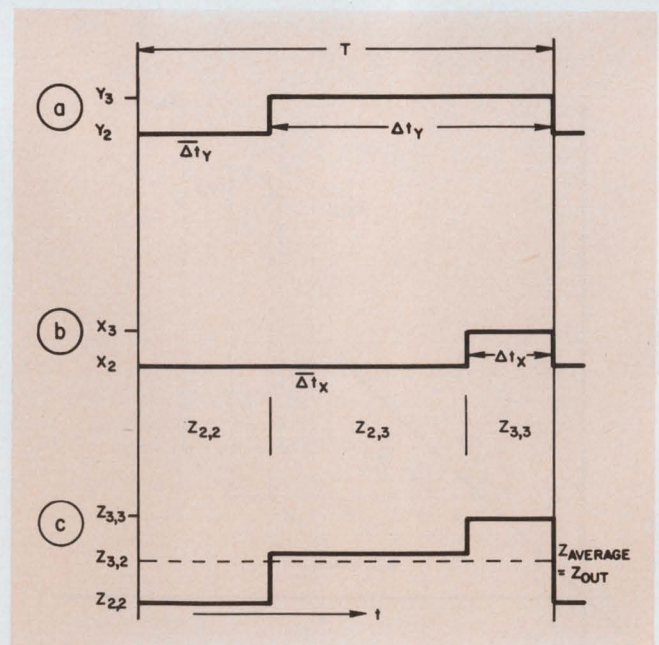

5. The timing diagram of the averaging circuit uses only three of the possible four corner values of Z_{ij} . Each value is allowed to exist for an interval related to ΔX or ΔY . This averaging method produces the same result as if Eq. 3 were implemented for each of the two flat planes.

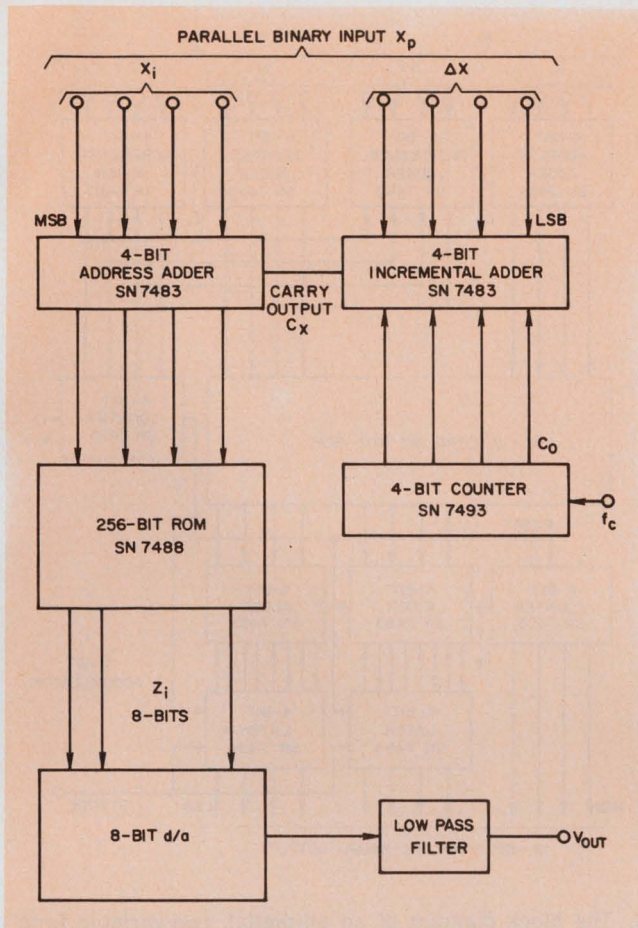

6. A single-variable function generator can be built with only five flat-pack ICs and a low-pass filter. The 256-bit ROM has twice the capacity required of this 16-point, 8-bit function generator.

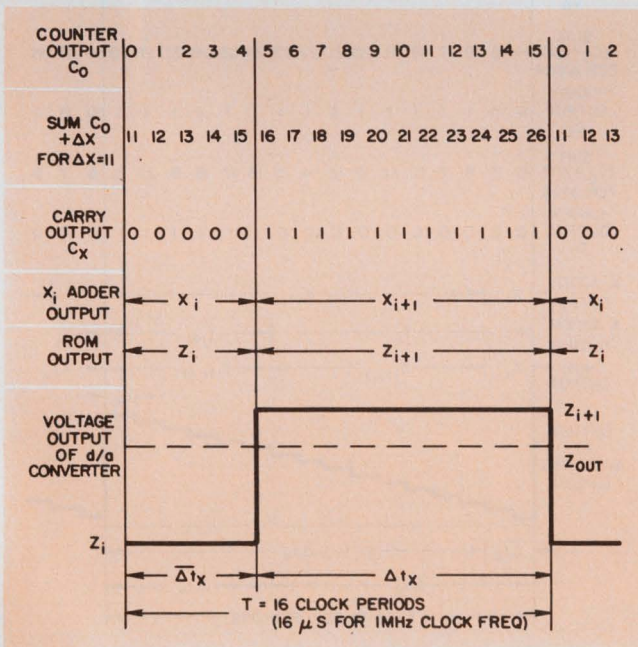

7. The counter output C_0 is added to the X increment to determine the carry output C_x . If ΔX is 11, the carry becomes 1 for all counter values between 5 and 15. The carry is 0 for counter values between 0 and 4. Z_i is the input to the circuit for $C_x=0$, and Z_{i+1} for $C_x=1$.

The corner values Z_{22} , Z_{23} , Z_{33} , or Z_{22} , Z_{32} , Z_{33} are averaged for appropriate intervals. These intervals, fractions of the x and y pulse repetition periods T (Fig. 5), are designated Δt_x and Δt_y . They represent the increments ΔX and ΔY . The diagram in Fig. 5c shows which corner value is used as the averaging circuit input and for how long: Z_{33} is fed in when both ΔX and ΔY are HIGH; Z_{23} is fed in from the instant ΔX goes LOW to the instant ΔY goes LOW; and Z_{22} is the input for the rest of the period T . This can be expressed analytically as follows:

$$\begin{aligned} \Delta t_x/T &= \Delta X / (X_3 - X_2) = \Delta X / (Y_3 - Y_2) \\ \Delta t_y/T &= \Delta Y / (X_3 - X_2) = \Delta Y / (Y_3 - Y_2) \\ T &= \Delta t_x + \Delta t_y = \Delta t_y + \Delta t_x \end{aligned}$$

The average value of the function is:

$$\begin{aligned} Z_{AV} &= [Z_{33}\Delta t_x + Z_{23}(\Delta t_y - \Delta t_x) + Z_{22}\Delta t_y]/T \\ &= [Z_{22}(T - \Delta t_y) + Z_{23}\Delta t_y + Z_{33}\Delta t_x - Z_{23}\Delta t_x]/T \end{aligned}$$

or:

$$Z_{AV} = [Z_{22}T + (Z_{23} - Z_{22})\Delta t_y + (Z_{33} - Z_{23})\Delta t_x]/T \quad (4)$$

Equation 4 is just another form of Eq. 3 in which T replaces $X_3 - X_2$ or $Y_3 - Y_2$, Δt_y replaces $Y - Y_2$ and Δt_x replaces $X - Y_2$. Thus the averaging method produces the same result as if Eq. 3 were implemented for each of the two flat planes.

Translate theory to hardware

In a single-variable function generator, a signal representing the values Z_i and Z_{i+1} must be stored and alternately fed into the averaging circuit. The fraction of the total period over which each is averaged is a function of the input X (Fig. 1).

The input signal X_p in Fig. 6 is an 8-bit parallel-binary signal—the independent variable X in the function $Z = f(X)$. The four most significant bits of X_p represent 16 fixed values of X_p . They address 16 values of Z_i stored in the ROM. The four least-significant bits of X_p identify the increment $\Delta X = X - X_i$ to a resolution of one in 16.

The averaging circuit may be analog or digital, depending on the type of output signal desired. As an example this single-variable function generator uses an analog averaging circuit.

The diagram in Fig. 6 shows the interconnection of the parts of a single-variable function generator. The 4-bit binary counter is pulsed at the clock frequency f_c . Its instantaneous output C_0 is stepped from 0 to 15 and is added to the value of ΔX , which lies between 0 and 15. The carry output of the ΔX adder C_x is a ONE, whenever the sum of the C_0 and ΔX is larger than 15. The length of time during which C_x is ONE is a direct function of ΔX .

Figure 7 shows that when $\Delta X=11$ (decimal), C_x is a ONE for exactly 11 clock pulses. The carry output from the ΔX adder is connected to the

carry input of the X_i adder. If C_x is ZERO the output of the adder is X_i . If, however, C_x is a ONE the output is X_{i+1} .

Thus the ROM is addressed with X_i if $C_x=0$, and with X_{i+1} if $C_x=1$. The output of the ROM is Z_{i+} for $C_x=0$ and Z_{i+1} for $C_x=1$. Figure 7 illustrates that for $\Delta X=11$, the output of the ROM is Z_{i+1} for 11 clock-periods and Z_i for five. If ΔX is constant this pattern repeats every 16 clock periods. With $f_c=1$ MHz, the repetition period T is approximately 60 kHz.

The d/a converts the digital outputs, Z_i and Z_{i+1} , into two voltages, V_i and V_{i+1} . A low-pass filter averages this 60-kHz rectangular wave so that the resulting dc voltage, V_{OUT} , represents the desired value. A repetition frequency of 60 kHz and a two-stage RC filter with break frequencies around 1 kHz provide a reasonably smooth output and a relatively high bandwidth (1 kHz).

The accuracy of such a function generator is dependent on several factors: The shape of the function and the number of segments determine how well the function is approximated, the resolutions of ΔX and Z_i determine how closely the input and output can be defined and, finally the accuracy of the output voltage is determined by the precision of the d/a converter.

Two-variable generator has digital output

The two-variable function generator makes use of the same principles as the single variable function generator. The values of the function at the corners of each sector are stored in the ROM. However, a much larger memory is required since there are two independent variables. If 16 values (four bits) of each independent variable are needed, the memory must store 256 values of the function (Fig. 8).

This function generator accepts two parallel, 8 bit, input words X_p and Y_p . The four most significant bits (MSB) of each address the ROM. The four least significant bits (LSB) provide the X and Y incremental values.

The interpolation between the corner values is carried out in a manner quite similar to the single-variable function with the added complication of the third dimension. An address and an incremental adder must be provided for each of the input variables. The carry output signals from the ΔX and ΔY incremental adders feed the inputs of the X_i and Y_j address adders. When both carries are zero, the outputs are X_i and Y_j . When the both carries are one, the outputs are X_{i+1} and Y_{j+1} . When the ΔX carry is zero and the ΔY carry is one, the output is X_i and Y_{j+1} . Finally, when the ΔX is one and the ΔY is zero, the output is X_{i+1} and Y_j .

A timing diagram of two-variable function

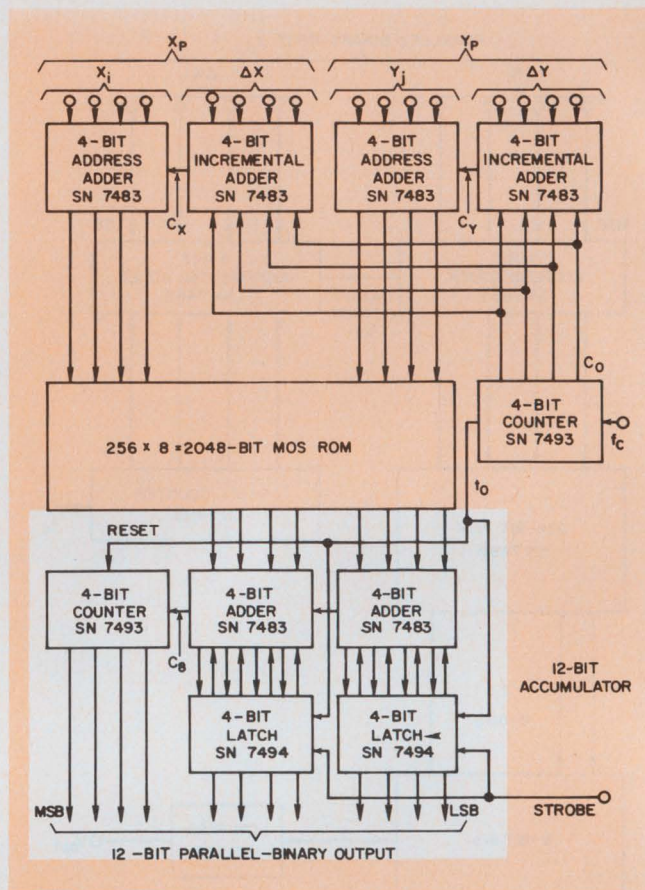

8. The block diagram of an all-digital, two-variable function generator shows only 11 flat-pack ICs. The output of this circuit is in a 12-bit digital format.

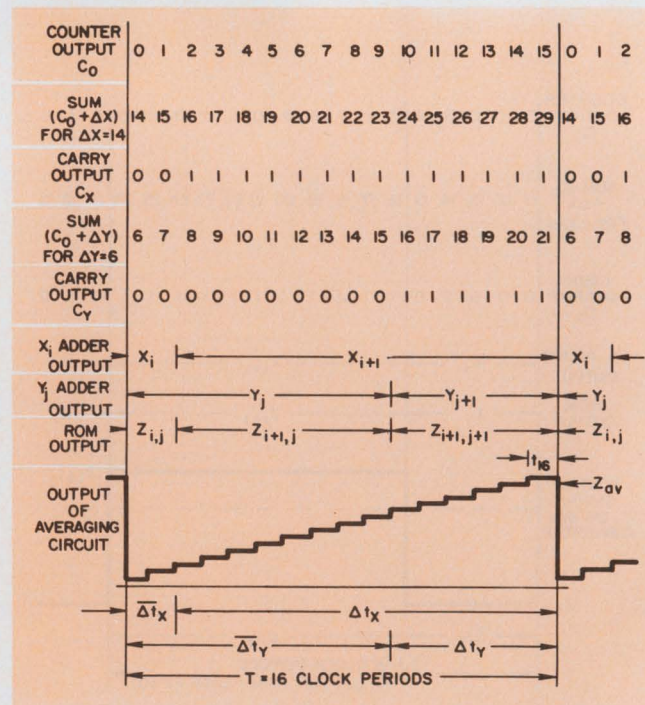

9. The timing diagram for the two-variable function generator shows how the X and Y increments determine the intervals in which the ROM outputs are fed to the accumulator. Compare this diagram to Fig. 7 to see how the one-variable case is generalized for two variables.

generator is shown in Fig. 9. When X_i, Y_j are the adder outputs, the ROM responds with $Z_{i,j}$. When X_{i+1}, Y_j are the outputs, the ROM output is $Z_{i+1,j}$, etc. The carry outputs from the incremental adders determine when the X and Y address values switch to the next higher level.

Note that the ROM sequence can be either $Z_{i,j}$ to $Z_{i+1,j}$ to $Z_{i+1,j+1}$ or $Z_{i,j}$ to $Z_{i,j+1}$ to $Z_{i+1,j+1}$. The first sequence occurs if the approximation follows the upper flat plane and the second if it follows the lower flat plane of Fig. 4c.

Since a digital output is desired, no d/a converter is needed. Instead, there is a digital averaging circuit (Fig. 8) consisting of a 12-bit accumulator using 4-bit adders, two 4-bit latches, and one 4-bit counter. The latch outputs are one set of the inputs to the adders. The eight outputs from the ROM constitute the other set of adder inputs.

At the beginning of each repetition period, T, the accumulator is reset to 0. Thereafter, the output of the ROM, $Z_{i,j}$, is added into the accumulator, once during each clock period t_{CL} increasing the content of the accumulator, in steps as a function of time:

$$Z(t) = \sum_{K=1}^{16} Z_{i,j} \Delta t_K$$

At the 16th clock period the output of the accumulator is:

$Z(t_{16}) = aZ_{i,j} + bZ_{(i+1,j)} + cZ_{(i+1,j+1)}$ where a, b and c are the number of clock pulses during which $Z_{i,j}$, $Z_{(i+1,j)}$ and $Z_{(i+1,j+1)}$ are available at the output of the ROM.

The carry output C_8 from the eighth accumulator stage generates a pulse whenever the 8-bit accumulator overflows. This pulse frequency determines a rate that is converted into parallel-binary form by the 4-bit counter. Figure 8 shows that the output of the function generator is the 12-bit parallel binary output signal of the accumulator. Since the accumulator output data is useful only during t_{16} , gating circuits must be provided if the receiving circuit does not have the gating capability.

When $f_c=1$ MHz, the function generator provides an output every $16 \mu s$; the maximum bandwidth is approximately 30 kHz because there are two outputs for every cycle of the input signal.

Number of bits determines accuracy

The digital-function generator repeats precisely because the data is always handled identically. However, the accuracy with which the output approximates the desired function is dependent on the number of bits in X_i and Y_j . More bits increase the number of sectors and improve both accuracy and resolution.

There is an interesting trade-off between the number of bits in X_i, Y_j and $\Delta X, \Delta Y$. When the function to be generated is smooth, the number of segments can be small without reducing the accuracy significantly. Hence, fewer X_i, Y_j bits and less memory are needed. However, to attain the same input resolution, a larger number of bits must be carried in ΔX and ΔY , thus increasing the size of the interpolation circuit and the time required for interpolating.

For example, if there are only three bits for X_i and Y_j and five bits for ΔX and ΔY , 5-bit interpolation must be used and the repetition period T is increased to 32 clock periods. The number of adder stages is unchanged, but the memory size decreases by a factor of four, from $256\text{-by-}8 = 2048$ bits to $64\text{-by-}8 = 512$ bits.

Normally, this is very desirable. Unfortunately, most functions are not smooth enough, so that high accuracy with flat plane approximation to the function can be obtained only with a large number of segments. ■■

References

1. Galli, E. J., "How Diodes Generate Functions," *Control Engineering*, March, 1959, pp. 109-113.
2. Ritchie, C. C., "The Design of Biased Diode Function Generators," *Electronic Engineering*, June, 1959, pp. 347-351.
3. Miura, T., "A New Diode Function Generator," *IRE Transactions on Electronic Computers*, June, 1957, pp. 95-100.
4. Schmid, H., "Linear Segment Function Generator," *IRE Transactions on Electronic Computers*, Dec., 1962, pp. 780-788.
5. Schmid, H., "Linear Segment Hybrid Function Generators," *Proceedings of the Combined Analog Digital Computer System Symposium*, Dec., 16, 1960.
6. Kubinec, J. J., "MOS Analog Function Generator," *MOS Brief 3*, National Semiconductor Corp., Santa Clara, Calif., Nov., 1968.
7. Ross, C., "Trig Function Generator," *MOS Brief 10*, National Semiconductor Corp., Santa Clara, Calif., Jan., 1970.

Test your retention

Here are questions based on the main points of this article. Their purpose is to help you make sure you have not overlooked any important ideas. You'll find the answers in the article.

1. How many bits of memory are required for generating functions of two variables?
2. Why is a single flat plane a poor approximation for a surface?
3. How are the clock frequency and the repetition frequency related?
4. What factors determine the accuracy of a digital function generator?

TRW covers the spectrum 3MHz to 3GHz

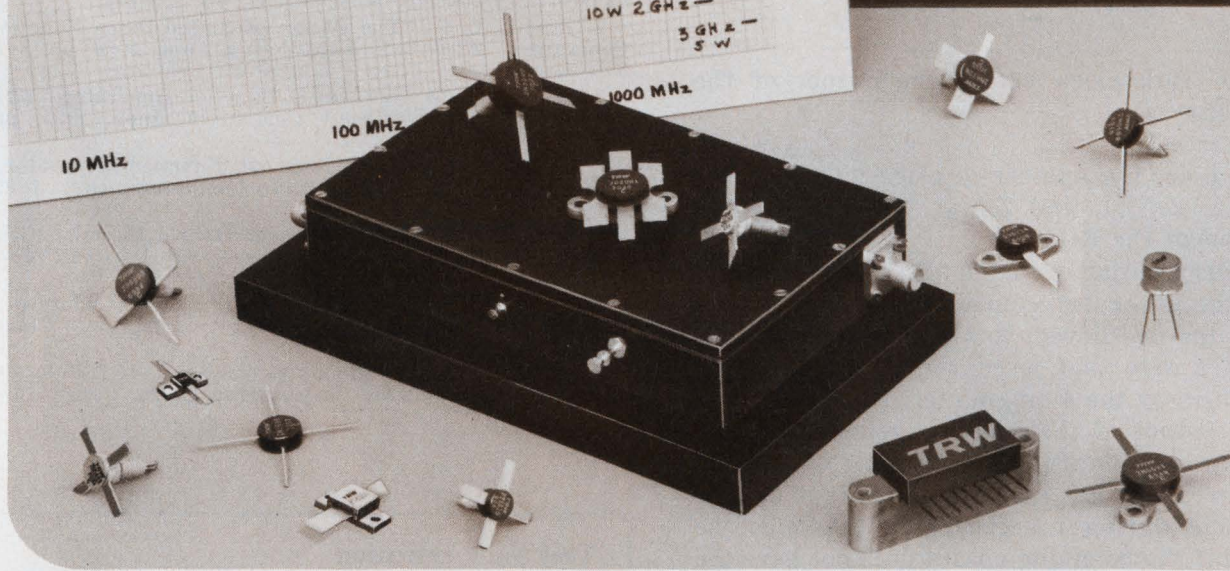
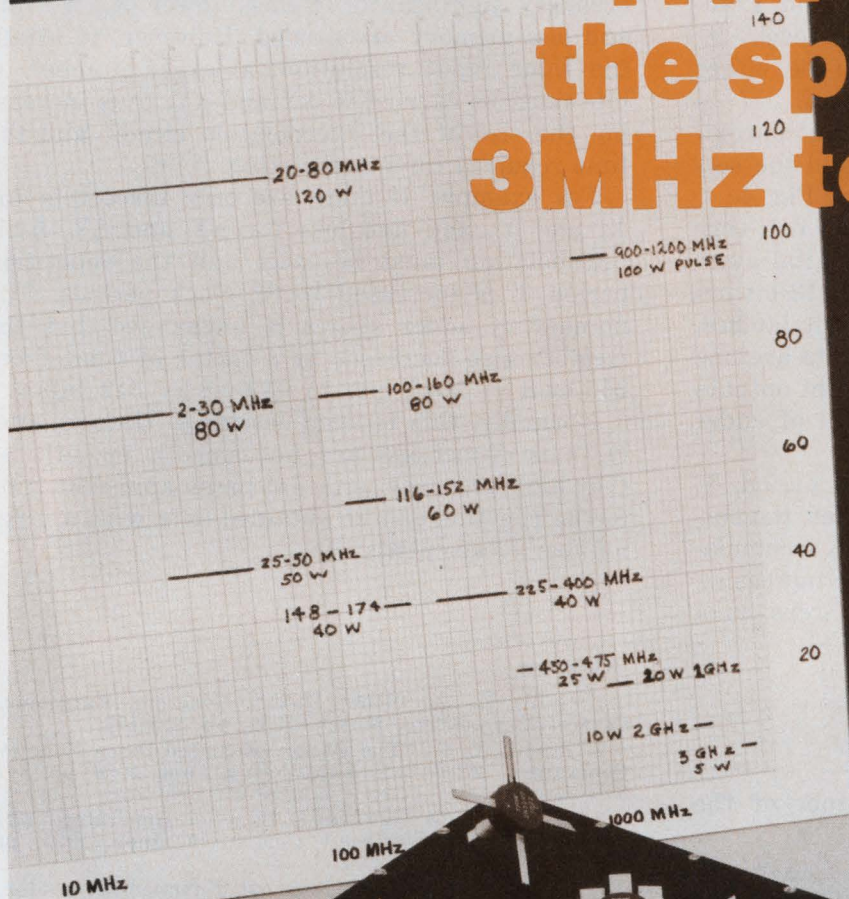

...with highest available solid state power

Wherever your application fits—from 3 MHz to 3 GHz—you can do the job with TRW RF power transistors. Broadband, state-of-the-art, and packaged for easy use. Not just output transistors, but a complete family for amplifier chain requirements in each band. Available off-the-shelf, with proven reliability to meet on-line frequency or amplifier/multiplier requirements for commercial and military land, mobile

and aircraft equipment. Backed up by in-depth product lines, packaging capability and applications know-how.

Even above 3GHz, TRW can help you. Our advanced technology provides reliable RF power at all frequencies for amplifier/multiplier design approaches. And if you need custom hybrid modules or MIC's to operate anywhere in the spectrum, we can help you there, too.

For complete information about TRW RF power transistor capability, contact TRW Semiconductor Division, 14520 Aviation Blvd., Lawndale, California 90260. Phone: (213) 679-4561. TWX: 910-325-6206.

TRW®

INFORMATION RETRIEVAL NUMBER 81

TRW 100W 1090MHz Hermetic Transistor

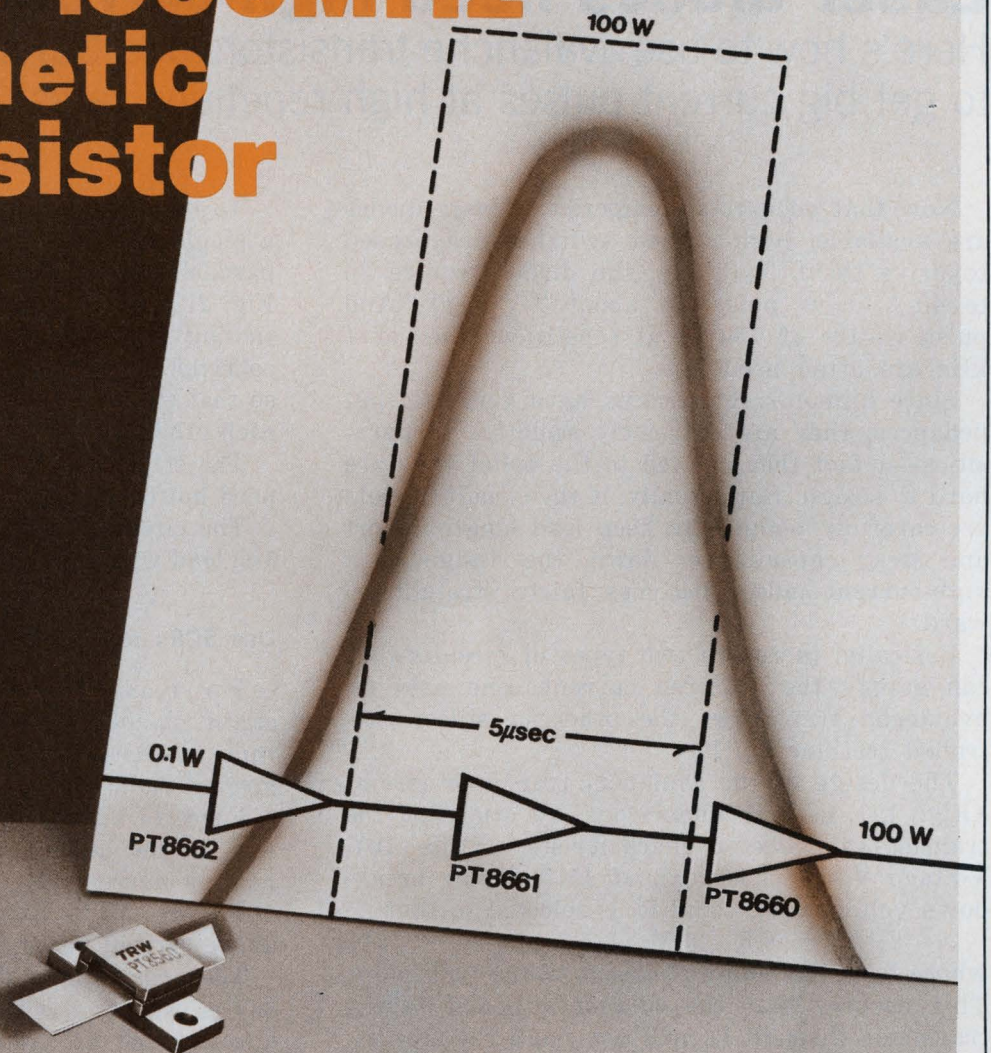

... delivers reliable Pulsed Power for DME, TACAN and IFF

8-72

Now you can design **all solid state** DME, transponders or radar equipment to meet ARINC, military and general aviation requirements. The key is a new TRW family of pulsed power transistors.

The broadband TRW PT8660 provides 100 Watts of peak pulse power with 10dB gain at 1090MHz. Used with companion transistors TRW PT8661 and PT8662, you get 30dB gain in a common base pulsed power

chain. And the PT8660's may be combined to meet even higher pulsed power requirements.

This new transistor family can also provide up to 50 watts of pulsed oscillator power to satisfy the source requirements for these avionics applications. All are packaged in the new HLP (**Hermetic**—Low Parasitic) package designed for easy use, optimum electrical and thermal characteristics.

For complete information on

INFORMATION RETRIEVAL NUMBER 82

this new TRW family of pulse transistors, contact any TRW distributor or TRW Semiconductor Division, 14520 Aviation Boulevard, Lawndale, California 90260. Phone: (213) 679-4561, TWX: 910-325-6206.

Actual Size



TRW®

Laser diodes need high-current drivers.

Here's how to use avalanche transistors and SCRs to get big current pulses at high repetition rates.

Now that good room-temperature laser diodes are available, high-current switches are needed to drive them. Typically, the diodes require 30 to 40-A drive pulses at about 3-V peak. And pulse widths of 150 ns at repetition rates of 1 kHz are often needed.

Since high-current circuits have very low impedances, they are extremely sensitive to parasitics—a fact that has led to the belief they are hard to design. But actually, if the circuit layouts are carefully planned to keep lead lengths short and stray capacitances down, the design of a high-current pulser becomes fairly straightforward.

Basically, there are two types of circuits that can supply the required current: one uses an avalanche transistor; the other, a silicon-controlled rectifier (SCR).

The design of the avalanche-transistor circuit (Fig. 1a) is best understood by studying the transistor's collector characteristics (Fig. 1b). Voltage V_{cc} is chosen about 15 V below breakdown voltage BV_{cex} , and R_1 is selected so that

$$R_1 > V_{cc}/I_H \quad (1)$$

where I_H is the holding current of the transistor. This ensures that the current supplied to the transistor through R_1 will not cause the transistor to go into avalanche before being triggered.

The value of R_L determines the slope of the ac load line. Capacitor C_1 charges up to V_{cc} through R_1 .

When a positive trigger pulse is applied, the transistor turns ON and C_1 discharges through R_L . (R_L , of course, would be replaced by a laser diode in an actual application.) As the capacitor discharges through the very low avalanche-mode impedance, a large current is produced. The rise time of the current pulse is determined by the speed with which the transistor can switch between its low-current state and the avalanche region. The pulse width is essentially determined by the time constant of the discharge circuit— $R_L C_1$.

To obtain more current than is possible with a single transistor, several can be connected in parallel, as in the two-transistor example of Fig. 2. Each transistor has a provision for adjusting its collector voltage so that all of the collector voltages are identical. This is essential so that the transistors all drive the load and not each other.

The trigger circuitry is not very critical and need not be adjustable.

The circuit of Fig. 2 will deliver 30 A into a 1- Ω load with a pulse width of 20 ns.

Use SCRs for higher currents

For really high-current switching, an SCR circuit should be used. SCRs that can switch currents in excess of 100 A at voltages above 1000 V are available.

Forward biasing the gate of the SCR turns it ON. If the anode current is greater than the holding current, I_H , the SCR will latch in the ON state. It is turned OFF by dropping the anode current below the holding-current level.

The operation of the basic SCR circuit (Fig. 3a) is very similar to that of the avalanche-transistor circuit discussed earlier. Again R_1 is chosen in accordance with Eq. 1 to keep the charging current below I_H . V_{cc} must be less than the forward blocking voltage to keep the SCR OFF until a trigger pulse is applied.

In the OFF condition, the capacitor charges up to the applied voltage. When a positive trigger pulse is applied to the gate, the SCR turns ON and the capacitor discharges through R_L . The rise time of the output pulse is determined by the SCR's turn-on time and the load resistance and capacitance in the discharge circuit. The pulse width is determined by the value of the RC time constant in the discharge path.

The maximum repetition rate of the circuit is about $1/4R_L C_1$. At this frequency the capacitor can charge to over 95% of its final value after each discharge. To increase the maximum repetition rate, a transistor can be added to the circuit (Fig. 3b).

Transistor Q_2 reduces the RC time constant by

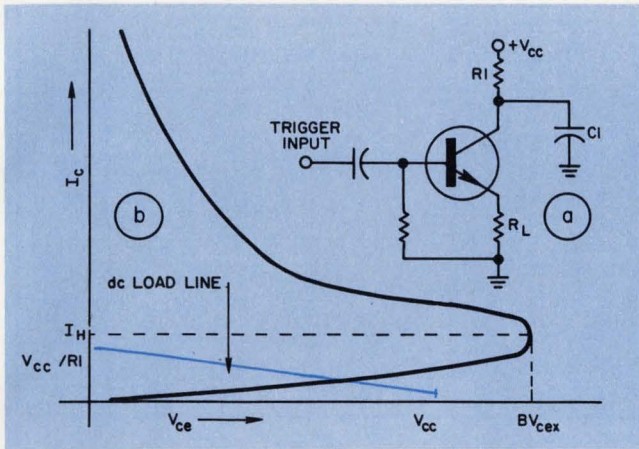

1. The transistor is kept out of avalanche until a trigger signal is applied, by choosing $R_1 < V_{cc}/I_H$ (a). I_H , the holding current, is the maximum collector current that can be sustained without causing avalanche (b). BV_{cex} is the collector-to-emitter breakdown voltage measured at a current less than I_H .

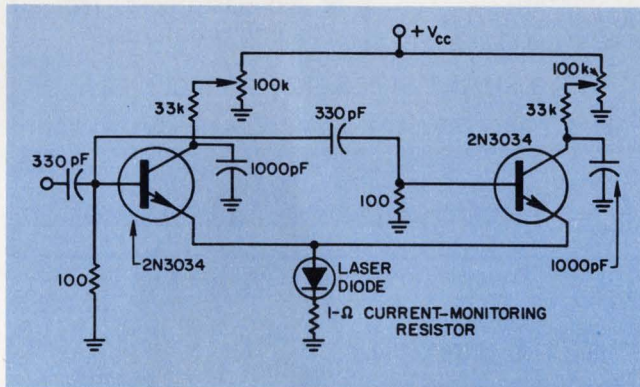

2. Two transistors are better than one when high currents are needed. Note that the collector bias voltages must be made equal if the problems arising from parallel operation are to be avoided.

supplying a low-resistance path through which the capacitor can charge up to the applied voltage. When the SCR, Q_1 , is triggered C_1 discharges, and the resulting voltage drop across the diode reverse-biases the base-to-emitter junction of Q_2 , leaving only R_1 between the SCR and the power supply. Since R_1 satisfies Eq. 1, the SCR shuts OFF when C_1 has discharged.

At this point, Q_2 turns ON because there is no longer enough voltage across the diode to keep it OFF, and C_1 can charge up very rapidly through the 1-kΩ resistor and Q_2 . Adding Q_2 increases the maximum repetition rate of the circuit from 100 Hz to 10 kHz.

Testing the SCR circuit

The test circuit of Fig. 4 was constructed to test the operation of the SCR circuit. The circuitry to the left of D_1 is a free-running oscillator used to provide trigger pulses to Q_2 , the SCR.

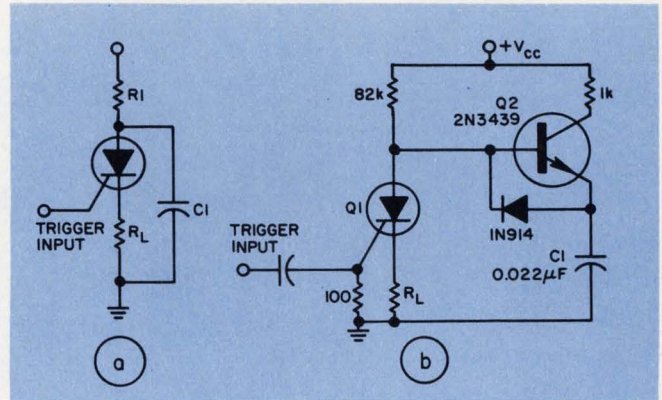

3. For very high currents an SCR circuit should be used (a). When the SCR is triggered, C_1 discharges through the load resistor. In an actual application, R_L would, of course, be replaced by a laser diode. Greatly increased speed is obtained by adding transistor Q_2 to the SCR circuit (b). It raises the circuit's repetition rate by providing a low-resistance charging path for C_1 when the SCR is OFF.

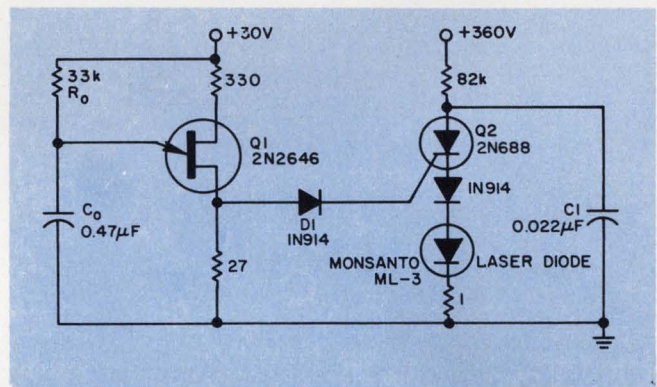

4. 40-A pulses are produced at about a 50-Hz rate by this experimental circuit. The unijunction-transistor circuit on the left generates trigger pulses for the SCR driver circuit on the right.

The load in the discharge circuit consists of a 1-Ω resistor and a clipping diode in series with the laser diode. The clipping diode is used to reduce the backswing on the pulse. The peak current is controlled by adjusting the supply voltage V_{cc} .

If rectangular pulses are desired, a charged line can be used in place of the charging capacitor, C_1 . In this case the pulse width is determined by the length of the line.

The frequency of the oscillator circuit is given by

$$f = \frac{1}{R_o C_o \ln [1/(1-\eta)]} \quad (2)$$

where η is the intrinsic standoff ratio of the unijunction transistor, Q_1 .

When operated, this circuit produced current pulses at a rate of approximately 50 Hz. The pulses had a peak current of 40 A and a duration of about 180 ns. ■■

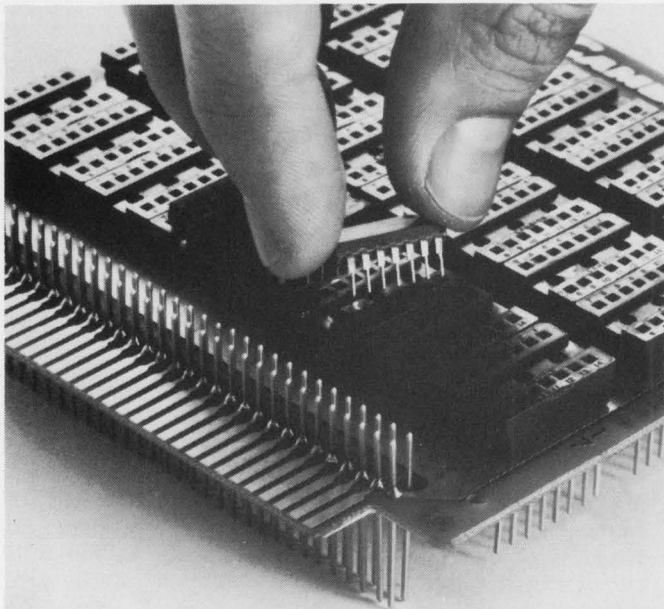

use our wire-wrap* cambi-cards to keep your ic's in line

Matter of fact, we'll help you package whole IC sub-systems. Start with our 4.5 x 4.5 inch or 4.5 x 9.25 inch Cambi-Card® printed circuit boards with 70-pin input/output edge connectors, containing Wire-Wrap sockets for 14, 16 or 24-pin dual in-line IC's. Then our precision fabricated card files with 13 or 26 positions. Next our 13 or 26 position power planes.

And if you need 'em, our card extenders, Wire-Wrap card connectors, blank Cambi-Cards for discretes, pluggable/patchable breadboards for 16, 32 or 64 DIPS, patch cord kits . . . even our super fast, economical wire-wrapping service.

For details, call us or write for Catalog 92, the latest word on IC accessories and wire-wrapping. Cambridge Thermionic Corporation, 445 Concord Avenue, Cambridge, Mass. 02138. Phone: (617) 491-5400. In Los Angeles, 8703 La Tijera Boulevard 90045. Phone: (213) 776-0472.

*Registered Mark of Gardner-Denver Co.

Standardize on

CAMBION®
The Guaranteed Electronic Components

INFORMATION RETRIEVAL NUMBER 28



**FOR
ROTARY
RECIPROCATING
OSCILLATING
OR STATIC
APPLICATIONS**

MADE FROM
TEFLON AND
GRAPHITE-TEFLON
WITH STAINLESS STEEL.

- Excellent corrosion resistance.
- Temperature from -70°F to 400°F.
- Self-adjustment for runout and wear.
- Very low friction.
- No elastomers - No aging problems.

FOR SHAFT SIZES .125 TO 6.00" DIA.
SEND FOR FREE SEAL SAMPLE AND CATALOG

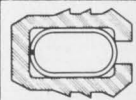

Bal-seal ENGINEERING CO.

17592 SHERBROOK DR., TUSTIN, CALIF. 92680 • 714/838-9640

INFORMATION RETRIEVAL NUMBER 29

ELECTRICAL

COMPAC

E2B

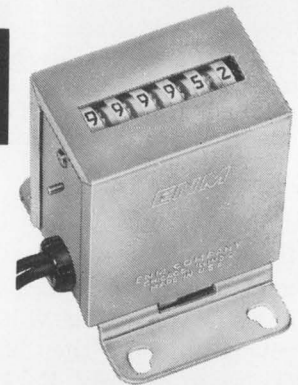

Life Tests:

Electrical impulse E2B counters, running at 600 counts per minute under laboratory conditions, have achieved the following—

50,000,000 counts—DC units;
15,000,000 counts—AC units;
Testing still in progress.

Accuracy: Complete reliability under variable test conditions.

Figures: 6-digits, black on white.

Voltages: 115 V. AC; 230 V. AC; 24 V. AC; and 24 V. DC. (4 watts)

Drive: New patented reciprocating Delrin verge.

Mounting: Base or panel mount.

Face Size: 1.72" W x 1.19" H x 2.34" D. (Net wt. 5 oz.)

Recognition: Meets U.L. and C.S.A. standards.

Delivery: Most voltages available from stock.

COVERED BY PATENT NO. 3,470,361

Write for literature. Application help available.



ENM COMPANY

5306 W. Lawrence Ave., Chicago, Ill. 60630

PHONE: (312) 282-8787 TELEX: 02-5468

Representatives in principal cities

INFORMATION RETRIEVAL NUMBER 30

ELECTRONIC DESIGN 20, September 27, 1970

the signal generator that's all things to all men



Constant Amplitude Generator

Automatically leveled outputs from 2.2 V (+20 dBm) to 0.01 μ V (-146 dBm) typically within ± 0.25 dB are provided - unobtainable from any other generator. . . Ideal for response testing of components (1 GHz) and to calibrate scopes, rf voltmeters, spectrum analyzers, etc.



FM Generator

Low distortion. Unique digital technique for adjusting deviation. At 500 MHz, deviation of 2.5 MHz is possible. Capable of handling FM stereo type signals.



RF Pulse Generator

Rise and fall times to 20 nanoseconds with a typical on-off ratio of 60 dB. Rep rates up to 500 kHz. Pulse widths as narrow as 4 microseconds are generated.



AM Generator

Covers the range from 61 kHz to 512 MHz in 1 unit. Has 100% modulation capability. AM bandwidth of DC to 200 kHz and lowest incidental FM available.



Video Generator

Can be video modulated over a bandwidth from DC to 100 MHz. Will simulate complex waveforms such as double sideband suppressed carrier.



Combination AM/FM Generator

No interaction between AM and FM. Use it for determining AM rejection of FM discriminators. Also apply it as a narrow band sweep generator with AM modulation for receiver testing.



and would you believe it's also a Counter

Reads generator output frequency to 5 places on a front panel Nixie readout. Also can be used as an external counter from DC to 2 MHz. Accurately monitors modulating rep rates.

A passive doubler raises output frequency to 1024 MHz.

The Singer Company
Electronic Products Division
915 Pembroke Street
Bridgeport, Conn. 06608.
203-366-3201.

*In Europe contact: Singer
Sewing Machine Company,
Electronics Products Division, P.O.
Box 301, 8034 Zurich, Switzerland,
Telephone: (051) 47 25 10*

it's the Model SG-1000

SINGER INSTRUMENTATION

Can a production job be creative?

This director of manufacturing thrives on his work and tells why he finds it a challenge.

Richard L. Turmail, Management Editor

Unlike many engineers today, Harvey P. Newquist really likes his job. He's the director of manufacturing at Data General Corp., Southboro, Mass., a producer of minicomputers and peripheral equipment, and he says that the more he works in production, the more he likes it. It gives him a challenge he didn't find in other areas of engineering.

"Channeling engineers into manufacturing is difficult, though," he said, recently, "because they'd rather design. They feel it's more creative."

Ironically, Newquist's job is, at least, as challenging as a designer's. Take the over-all responsibility he has, for example, for keeping his firm's productivity in line with costs. This is no small task during these days of slackening sales. He does it, however, by staying "lean and mean."

Newquist explained that expression this way: for the sake of efficiency, and no matter what the economic climate, he hires only those whose contribution can be measured, and he tries to measure that contribution regularly. He also looks for production methods that will improve his operation.

Learning from the leaders

Newquist's production operation involves sheet-metal fabrication, assembly of circuit boards and power supplies, and the installation of completed circuit boards and a power supply in a metal chassis. Products have been standardized, and no custom work is done. The maximum use of medium-scale integrated circuits has dramatically reduced production time and the cost of production.

Newquist created the manufacturing procedure for the company's two computer lines, the Nova and the faster Supernova. Over 600 installations, the classic measure of success, have been attained in little more than one year of production.

Unique experience in test and assembly has given Newquist a healthy respect for production. A BS graduate of the University of Notre Dame,

Newquist participated in a General Electric engineering program testing diesel-electric locomotives and motor and turbine generators. This is certainly not the ordinary engineering assignment. Later, he served as the quality-control manager of the Navy aircraft early warning and detection system at GE's Light Military Electronics Div., Utica, N.Y. After that, he established the computer manufacturing capability for Honeywell at Framingham, Mass.

Newquist says that much of his computer production experience is the result of working with the circuit boards and modules that were given to him for assembly by the now leading and competing computer producers.

"These companies," he said, "started 20 years ago by making computer parts to fulfill Government contracts. Some 10 years or so ago they brought their circuit boards and modules to me to put together when I was at GE in Utica. Eventually, these companies evolved their own production process so they could assemble their own products."

According to Newquist, most computers a decade ago were composed of hundreds of small modules—a manufacturing manager's nightmare.

"Our production operation at Data General is simplified by the use of two big circuit boards—one for each computer—that replaced 500 modules," Newquist said. "Just think of all the connections we don't have to make! We not only found a more producible way to make a computer—we've also been able to design all our other products around these same big boards."

Success depends on quality control

Newquist says that if a manufacturer is responsible for producing a highly technical product, like a computer, a big difference between a good manufacturing operation and an excellent one is the engineering capability to maintain quality control.

The success of the quality-control function of manufacturing, according to Newquist, is measured by customer acceptance of the product. And he explains why.



On the job at Data General Corp., Southboro, Mass., Harvey P. Newquist, director of manufacturing, checks

During his days with the testing program, he noticed that the salesmen always oversold the product—and the customer saw the product too late to make any changes. To preclude this possibility in his own production operation, Newquist instituted “close coupling,” the term used to describe regular meetings between the designer and the manufacturer and sometimes the customer, to discuss the product, its applications and its changes. Close coupling is extremely important if the product being manufactured is

over a computer line he’s responsible for producing. He created the firm’s manufacturing procedure.

complex and certain to undergo a high degree of change.

If the manufacturing manager is to make a worthwhile contribution at these product meetings, Newquist believes he should have the following qualifications:

- An engineering degree.
- Three to five years of experience in one of the product areas as a designer, or as an engineer in a test program.
- An inherent ability to express himself to the

A young computer firm calculates its success..

When a score of engineers got together in April, 1968, to decide what computer was most needed on the market, the Nova, a 16-bit-word, small-scale, general-purpose, digital computer was the result, and Data General Corp. was in business.

Since its inception, this manufacturer of mini-computers and associated peripheral equipment has operated as a loosely structured organization, keeping its middle management force to a minimum. Little emphasis has been placed on organizational charts because, as the company's director of manufacturing put it: "We want to attract able people into the company and not worry too much about where they will work." The company now has more than 200 full-time employees, including 45 engineering and programming personnel.

Proof that the company's approach to design, production and sales has been correct is that in less than three years, it is among the top five mini-computer producers. Most of these, one Data General official says, have been

in business for about 20 years.

Additional confirmation that the company has been computing a straight course for itself can be found in its sales figures, which have risen from zero in September, 1968, to an estimated \$7-million in September, 1970. In the same period, earnings have about-faced from a loss of \$104,927 to a profit of an estimated \$700,000.

Rising sales have forced the company to stretch its original 10,000 square feet of executive offices and manufacturing facilities in Southboro, Mass., to seven times that area. An additional 150,000 square feet is presently under construction.

The company estimates it had approximately 3% of the computer market in 1969. Its goal of market penetration is 10% in 1971 and 20% by the end of the next five years. Based on current projections of a \$750-million market by 1975, this could indicate a sales goal of \$150-million for the company within seven years of its founding.

customer concerning product changes and to help close the sale of the item.

■ He must like the work—in fact, he must thrive on it.

These qualifications are based on Newquist's experience with the GE testing program. According to Newquist, GE had found that administrators in the position of manufacturing managers had a tendency to expect the designer had time and a capability based on experience to handle changes. When close coupling was necessary, the administrator lacked the experience to contribute. GE then tried to improve the program by training graduate engineers as production managers instead of administrators. The program eventually deteriorated, however, because graduate engineers couldn't afford to take a three-year sabbatical from the state-of-art to learn manufacturing management.

"I conclude from that company's experience that you can't train a man to be a production manager," Newquist said. "He must be found, and many electronic firms have yet to find the right man for the job."

Engineers with the proper mix of experience to qualify as production managers do exist, however, and can be found if the company offers the right inducement.

One method Newquist uses to attain quality in production, is to stress human dignity when he manages his production people.

"I've found," he said, "that an employee wants to be known by his name, not his employee badge number. I've also found, for example, that by

providing him with a more expensive cushioned chair, instead of the usual hard-seated one, and by giving him the same employee benefits that salaried personnel are allowed, he is assured that we are thinking of his welfare." That assurance undoubtedly has an effect on his production.

The production people are also given responsibility. They are trained to assemble only part of a circuit board until they've proved they can do the work. Then they are expected to assemble the entire board by themselves, and sign it when they have finished. Newquist estimates that although it takes 20 per cent longer to assemble each board singly, fewer errors show up during the test phase of the board, than when each board is assembled by more than one person.

Each production employee is also trained to work around missing parts. However, in an attempt to have parts on hand at all times, Newquist says he deals with a large number of suppliers, so that he always has one to call.

For assembly and test operations, Newquist uses metal tables that are light, easy to handle and foldable. They can be arranged in almost any configuration for any production job.

"It makes our operation faster and more versatile," he said.

Of course, confidence plays an integral part in the success of a good production operation—the kind of confidence that Newquist displayed when his company told him it had decided on the big circuit boards for its computers. Without a single worry about producing the line, Newquist had said: "When do we ship it?" ■■

Product Source Directory

PC-Board Connectors

The PC-board connectors covered in this Product Source Directory are divided into two groups—edge-card units and plug-and-receptacle units—and then arranged alphabetically according to manufacturer.

The values shown for contact resistance are only representative since these can vary with

contact size and materials. No specific test voltage applies to the insulation-resistance call-out.

Manufacturers are identified by the abbreviations shown in the Master Cross Index below. The following abbreviations are used in the tables: ina—information not available
n/a—not applicable

Abbrev.	Company	Information Retrieval No.
AMP	AMP Inc. Box 3608 Harrisburg, Pa. 17105 (717) 564-0101	440
AirBorn	AirBorn, Inc. 2618 Manana Dr. Dallas, Tex. 75220 (214) 357-0274	441
Amphenol	Amphenol Corp. Industrial Div. 1830 S. 54th Ave. Chicago, Ill. 60650 (312) 242-1000	442
Armel	Armel Electronics 1601 75th St. N. Bergen, N.J. 07047 (201) 869-4300	443
Augat	Augat Inc. 36 Perry Ave. Attleboro, Mass. 02703 (617) 222-2202	444
Bendix	Bendix Corp. Electrical Components Div. Sidney, N.Y. 13838 (607) 563-9511	445
Berg	Berg Electronics, Inc. York Expressway New Cumberland, Pa. 17070 (717) 938-6711	446
Burndy	Burndy Corp. Richards Ave. Norwalk, Conn. 06852 (203) 838-4444	447
CC	Components Corp. 106 Main St. Denville, N.J. 07834 (201) 627-0290	448
Cambion	Cambridge Thermionic Corp. 445 Concord Ave. Cambridge, Mass. 02138 (617) 491-5400	449

Abbrev.	Company	Information Retrieval No.
Continental	Continental Connector Corp. 34-63 56th St. Woodside, N.Y. 11377 (212) 899-4422	450
Dale	Dale Electronics Box 609 Columbus, Neb. 68601 (402) 564-3131	451
Elco	Elco Corp. Maryland Rd. & Computer Ave. Willow Grove, Pa. 19090 (215) 659-7000	452
Hughes	Hughes Aircraft Co. Connecting Devices Div. Box H Newport Beach, Calif. 92663 (714) 548-0671	453
IEH	Industrial Electronic Hardware Corp. 109 Prince St. New York, N.Y. 10012 (212) 677-1881	454
ITT	ITT Cannon Electric 3208 Humboldt St. Los Angeles, Calif. 90031 (213) 225-1251	455
Loranger	Loranger Manufacturing Corp. P.O. Box 948 Warren, Pa. 16365 (814) 723-8600	456
3M Co.	3M Co. 3M Center Building 224 6E St. Paul, Minn. 55101 (612) 733-1110	457
Malco	Malco Manufacturing Co., Inc. 5150 W. Roosevelt Rd. Chicago, Ill. 60650 (312) 287-6700	458
Masterite	Masterite Industries Sub. of Houston Fearless Corp. 2841 W. Lomita Blvd. Torrance, Calif. 90505 (213) 775-3471	459

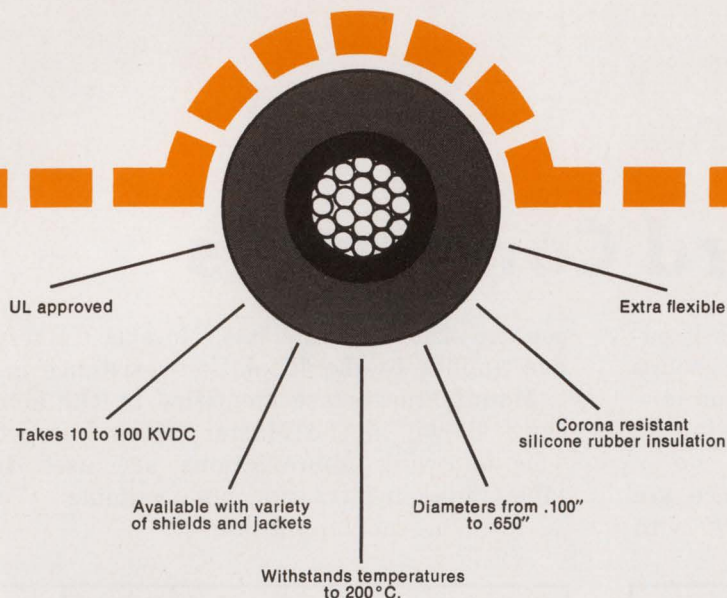

Send for new free data sheets on BIW's UL-approved silicone high-voltage cable

Gentlemen:

I'm interested in knowing more about BIW's UL-approved silicone high-voltage cable, available in eight standard types and sizes for fast delivery. We use high-voltage cable for:

(Radar, Xenon flash tubes, CRT leads, etc.)

Please send data sheets to:

Name _____

Title _____

Company _____

Street _____

City _____ State _____ Zip _____

Check here for data on BIW's UL-approved silicone high-voltage CRT Anode Lead Assemblies — an example of what 30 years of experience with high-voltage cable and assemblies might accomplish for you.



Boston Insulated Wire & Cable Company

65 Bay Street, Boston, Mass. 02025 • Tel: 617-265-2104
 El Segundo, California 90245; Hamilton, Canada;
 Kingston-upon-Thames, U.K.; GEDEBIW, S. A. - Clichy, France

Abbrev.	Company	Information Retrieval No.
Methode	Methode Electronics Inc. 7447 W. Wilson Ave. Chicago, Ill. 60656 (312) 867-9600	460
Mi-Kro	Mi-Kro Connector 40-09 21st St. Long Island City, N.Y. 11101 (212) 392-8814	461
Microdot	Microdot Inc. 220 Pasadena Ave. S. Pasadena, Calif. 91030 (213) SY 9-9171	462
Milross	Milross Controls Inc. 511 2nd St. Pike Southampton, Pa. 18966 (215) 355-0200	463
Molex	Molex Inc. 5224 Katrine Ave. Downers Grove, Ill. 60615 (312) 969-4550	464
National	National Connector Corp. Div. of Fabri-Tek Science Center Drive Minneapolis, Minn. 55427 (612) 533-5361	465
Sealectro	Sealectro Corp. 225 Hoyt St. Mamaroneck, N.Y. 10543 (914) 698-5600	466
Staffall	Staffall Inc. 7 Woodland St. Providence, R.I. 02908 (401) 351-8282	467
TI Inc.	Texas Instruments Inc. Connector Products 34 Forest St. Attleboro, Mass. 02703 (617) 222-2800	468
Transitron	Transitron Electronics 168-182 Albion St. Wakefield, Mass. 01880 (617) 245-4500	469
U.S.C.	U.S. Components, Inc. 1320 Zerega Ave. Bronx, N.Y. 10462 (212) 824-1600	470
Vector	Vector Electronic Co., Inc. 12460 Gladstone Ave. Sylmar, Calif. 91342 (213) 365-9661	471
Vero	Vero Electronics 176 Central Ave. Farmingdale, N.Y. 11735 (516) 694-6550	472
Viking	Viking Industries Inc. 21001 Nordhoff St. Chatsworth, Calif. 91311 (213) 341-4330	473
Winchester	Winchester Electronics Div. of Litton Industries Main & Hillside Aves. Oakville, Conn. 06779 (203) 274-8891	474

Manufacturer	Series	Contacts (Min-Max)	Contact Spacing (Mils, Min-Max)	Contact Rating (A, Min-Max)	Contact Resistance (mΩ, Min-Max)	Insulation Resistance (MΩ)	Sea-Level Test Voltage (V rms)	Notes
AMP	Amp-Tab	10-43	100-156	5	6	5000	1800	1a;B
AMP	Amp-Unyt	2-20	156	5	ina	ina	2000	1a;A
AMP	Ampleaf	8-32	156	5	2	5000	1800	1a;B
AMP	Dual Tine	2-30	100-156	3	30	ina	1000	1f;A
AMP	Duo-Tyne	3-22	156	16	15	5000	2200	1a;A
AMP	Modified fork	3-33	156	5	6	5000	1800	1af;A
AMP	Termi-Plate	14-44	150-200	5	3	5000	1800	1k;B;D
AMP	Termi-Twist	15-43	100-156	5	2	5000	1800	1k;B
AMP	Twin Leaf	3-50	100-156	3	6	5000	1500	1f;B
Amphenol	143	6-43	156	5	25	5000	1800	1dfh;A
Amphenol	225	6-100	100-156	5	6-7	5000	1800	1adfg;A;B
Amphenol	261	15-86	100-200	5-7.5	4.5-6	>5000	1800 min	1h;A;B
Augat	14005-1P1	60	100	5	8 max	>2x10 ⁶	2300	1h;B
Burndy	PB, PBD	15-50	100	3	ina	5000 min	800	1b;B
Burndy	PC	8-43	156	5	ina	5000 min	1800	1b;B
Burndy	PSC	10-43	156	3	ina	5000 min	1200	1c;A;B
Burndy	PSE	10-25	50	1	ina	5000 min	600	1c;A;B
Burndy	PWC	15-43	156	5	ina	5000 min	1500	1h;A;B
Burndy	PWH	23	200	5	ina	5000 min	1500	1h;A;B
CC	Digi-Klip	1	50 min	2	5	n/a	n/a	1c;A;(2)
Cinch	Mini-Tyke 259	20	100	0.5	20	5000	500	1f;A
Cinch	Miniature 253	60-72	125	3	16	5000	1800	1h;B
Cinch	Miniature 259	48-80	125	5	5	1000	830	1h;B
Cinch	Modular 253	4-6	125-200	ina	ina	ina	ina	1h;B;C
Cinch	Special 251, 253	16-60	156	5	5	5000	830	1dh;B;J
Cinch	Standard 250, 251, 252, 253	6-50	156	5	5	5000	830	1dfh;A;B
Cinch	Standard 253	15-50	156	3	16	ina	2000	1h;B
Cinch	Standard 253, 259	30-44	156	5	5	5000	830	1hm;B
Cinch	Twin-Con 254	16-86	156	5	5	5000	500	1a;B
Cinch	Tykon 255	12-50	50	0.5	20	5000	500	1fh;B;H
Cinch	Varicon 271	41	200	10	5	5000	1500	1h;A
Cinch	Varicon 7001, 7008	17-47	200	10	5	25,000	2000	1cdfghin;A
Cinch	Varicon 7009	34-40	200	10	5	25,000	1800	1a;A
Continental	600-2	10-64	50	1	15	>1000	900	1fi;B
Continental	600-6	10-64	50	1	ina	ina	900	1fi;B
Continental	600-11	6-43	156	5	6 max	>5000	1665	1dfh;A;B
Continental	600-83	18-43	200	5	8 max	>5000	2100	1dfh;A;B
Continental	600-100	10-50	100	3	ina	ina	1400	1dfh;A;B
Continental	600-121	10-50	100	3	7 max	>5000	1500	1dfh;A;B
Continental	600-125	6-50	125	3	ina	ina	1350	1dfh;A;B
Continental	600-128	6-50	125	3	7 max	>5000	1400	1dfh;A;B
Continental	600-156	6-43	156	5	6 max	ina	1665	1dfh;A;B
Continental	672, TJ	1-63	156-200	5	5 max	>5000	1650 min	1f;A;B;K
Dale	EBT156	8-22	156	5	6	5000	1800	1cfh;A
Dale	EBTL050	8-128	50	0.5	20	5000	1200	1f;A;B
Elco	6007	6-44	156	5	6	25,000	2000	1cgh;A;B
Elco	6018	36-72	156	5	6	5000	1800	1h;A;B
Elco	6019	22-44	156	5	6	5000	1800	1h;A;B
Elco	6020	84	200	5	15	5000	1800	1h;B
Elco	6021	15-30	156	5	6	5000	1800	1h;A;B
Elco	6022	22-44	156	5	6	5000	1800	1cg;A;B
Elco	6023	43-86	156	5	6	5000	1800	1h;A;B
Elco	6024	18-36	156	5	6	5000	1800	1cg;A;B
Elco	6026	18	150	5	6	25,000	1800	1h;A
Elco	6027	14	100	3	6	25,000	1800	1h;B
Elco	6028	14-28	100	3	6	25,000	1800	1h;A;B
Elco	6030	15-30	156	5	6	25,000	2000	1cg;A;B
Elco	6061	46	200	5	6	2000	1800	1h;B
Elco	6302	48	125	3	16	1000	1800	1h;B
Elco	6308	4-6	150	5	6	5000	1400	1h;B;C
Elco	6309	25-100	100	3	10	5000	1800	1h;A;B
Elco	6310	36	150	5	6	1000	1800	1h;B
Elco	6313	20-80	125	6	8	25,000	1800	1h;A;B
Hughes	EM3	30-136	100	7	30 max	5000 min	1000	1a;B
Hughes	EPC	20-100	50	3	30 max	5000 min	375	1c;B
Hughes	ERS	30-96	156	7	30 max	5000 min	1800	1a;B
IEH	TPA6000	15-18	156	5	30 max	5000	5400 max	1cfha;B
ITT	EC4	22-96	100	3	10 max	5000 min	1000	1h;A;B
ITT	EC55	N	125	3	10	5000	1000	1h;A;B;M
Loranger	2289	60	156	ina	ina	ina	ina	1h;B
3M Co.	3415	50	50	1	ina	ina	1500	1a;P;X
Malco	Cardec 125	N	125	5	7	5000	1500	1h;A;B
Malco	Cardec 200	N	200	6	5	10x10 ⁶	2500	1h;A;B
Masterite	005	24-352	50	0.5	10	1000	250	1fi;B
Masterite	008	30-160	100	3	8	500,000	1000	1dfh;B
Masterite	014	6-86	156	5	6	500,000	1800	1cdfh;A;B
Microdot	Mini-Mate	40-184	50-100	3	4	5000	1000	1c;A;B;P
Molex	Right Angle	6-24	156	10	1.522	ina	2200 max	1a;A;I
Molex	Straight-On	6-24	156	10	1.522	ina	2200 max	1a;A;I
National	2274	28	156	5	5	5000	1800	1d;A

Manufacturer	Series	Contacts (Min-Max)	Contact Spacing (Mils, Min-Max)	Contact Rating (A, Min-Max)	Contact Resistance (mΩ, Min-Max)	Insulation Resistance (MΩ)	Sea-Level Test Voltage (V rms)	Notes
National	2295, 200030	10-15	156	5	5	5000	1800	1f; A; K
National	2342, 2343, 200271	7-18	150	5	5	5000	1800	1dh; A; B
National	200125, 200261	56-112	100	5	5	5000	1800	1f; B; I; M
National	200150	18-36	200	5	5	5000	1800	1h; B
National	200242, 200243, 200244	15-44	156	5	5	5000	1800	1df; B
National	250025, 250052	10-15	156	5	5	5000	1800	1bh; A
National	510355, 510383, 510394, 510405	N	100-200	5	5	5000	1800	1h; A; M
National	A-2100	N	156	5	5	5000	1800	1b; B
National	A-2280, A-2289	20-80	50	1	5	1000	900	1cip; B
Staffall	550-12	12-24	156	0.196	3	>0.01	1000 min	1cg; B; J
Staffall	550-15	15-30	156	0.196	3	>0.01	1500	1cg; B; J
Staffall	550-18	18-36	156	0.196	3	>0.01	1000 min	1cg; B; J
Staffall	550-22	22-44	156	0.196	3	>0.01	750 min	1cg; B; J
Staffall	550-31	31-61	125	0.196	3	>0.01	750 min	1cg; B; J
Staffall	550-41	41-82	125	0.196	3	>0.01	750 min	1cg; B; J
TI Inc.	9000	22-44	100	3	ina	5000 min	ina	1c; A; B; (1)
Transitron	061, 062	6-28	156	3	6	5000	1800	1df; A; B
Transitron	093	15-25	156	3	6	5000	1800	1df; A; B
Transitron	093E	31	125	3	6	5000	1800	1df; A; B
Transitron	25007	28-72	100	3	6	5000	1200	1h; A
U. S. C.	UP4CR-28, -P28, -DS	28	125	5	5	10x10 ⁶	1400	1df; A; S
U. S. C.	UPC2R-D18	36	200	5	5	10x10 ⁶	1800	1dg; B
U. S. C.	UPCR	6-22	156	5	5	10x10 ⁶	1800	1df; A; S
U. S. C.	UPCR-D	12-44	156	5	5	10x10 ⁶	1800	1dfgpr; B; S
U. S. C.	UPCR-GD65-MX	130	100	5	5	10x10 ⁶	1200	1c; B
U. S. C.	UPCR93-D	12-44	156	5	5	10x10 ⁶	1800	1d; B; S
Vero	2236	40-80	100	5 max	10	5000	700	1c; A; B
Vero	2245	22-44	156	5 max	10	5000	700	1c; A; B
Vector	R624	24	156	5	5	5000	2500	1c; B
Vector	R636	72	100	5	6	5000	1800	1h; B
Vector	R644	44	156	5	5	5000	2500	1c; B
Viking	2VH A	6-86	156	5	6	5000	1800	1fp; A; B
Viking	2VH ANE	12-86	156	5	6	5000	1800	1h; B
Viking	3VH C	12-100	125	3	10	5000	1000	1fh; B
Viking	3VH J	12-100	100	3	7	5000	650	1fh; B
Viking	VH L	20-132	50	0.5	15	5000	375	1f; B
Viking	Vikom 2VK	6-86	156	5	6	5000	1800	1ft; A; B
Winchester	8B	6-60	156	5	6 max	ina	ina	1dfgh; A; B
Winchester	HB	6-56	156	5	6 max	ina	ina	1dfh; A; B; T
Winchester	HK	6-56	156	5	6 max	ina	ina	1dfh; A; B
Winchester	HW-C	20-100	100	5	5 max	ina	ina	1h; B
Winchester	HW-D	28-100	125	5	5 max	ina	ina	1h; B
Winchester	K	6-22	156	5	6 max	ina	ina	1ej; A
Winchester	KKM	6-22	156	5	4 max	ina	ina	1d; A
Winchester	KM	14-44	78	5	5 max	ina	ina	1d; A
Winchester	PBH	25-50	150	5	6 max	ina	ina	1dfgh; A; B
Winchester	PCM	20-100	50	1	15 max	ina	ina	1f; A; B
Winchester	PJDH	25-50	150	5	6 max	ina	ina	1dfgh; B
Winchester	PQ	31-62	125	5	6 max	ina	ina	1dfgh; A; B

1. Contact termination

- a. crimp
 - b. removable crimp
 - c. solder
 - d. solder eyelet
 - e. solder cup
 - f. dip solder
 - g. tapered pin
 - h. wire-wrap
 - i. weld
 - j. turret
 - k. Termi-Point
 - m. slip-on clip
 - n. buss line
 - p. bent pin
 - q. tuning fork
 - r. linked tapered tab
 - s. printed circuit tab
 - t. notched
- A. Single-sided connectors
 - B. Double-sided connectors
 - C. Modular unit-type connectors
 - D. Metal-plate connectors
 - E. Leaf-type connectors

F. Open and closed-entry-type sockets

- G. Chevron-shaped contacts
 - H. Ribbon-type contacts available
 - I. Right-angle connectors
 - J. Bridged design available
 - K. Test-point connectors
 - M. Modular plate-type connectors
 - N. Any number of contacts available
 - P. Two-piece connectors
 - Q. Office-of-Naval-Ordnance connectors
 - R. Jack-type connectors
 - S. Meets MIL-C-21097
 - T. Meets MIL-C-23353
 - U. Meets MIL-C-55302
 - V. Removable contacts
 - W. Closed-entry-type jacks
 - X. Connectors accept round-conductor flat cable
 - Y. Plugs only
 - Z. Receptacles only
- (1) Standard impedance is 50Ω
 - (2) Single-clip U-shaped connectors
 - (3) Straight and right-angle connectors available
 - (4) Military types SMB and SMC

Guess what our new TWIN-LEAF[★] connector saves besides space?

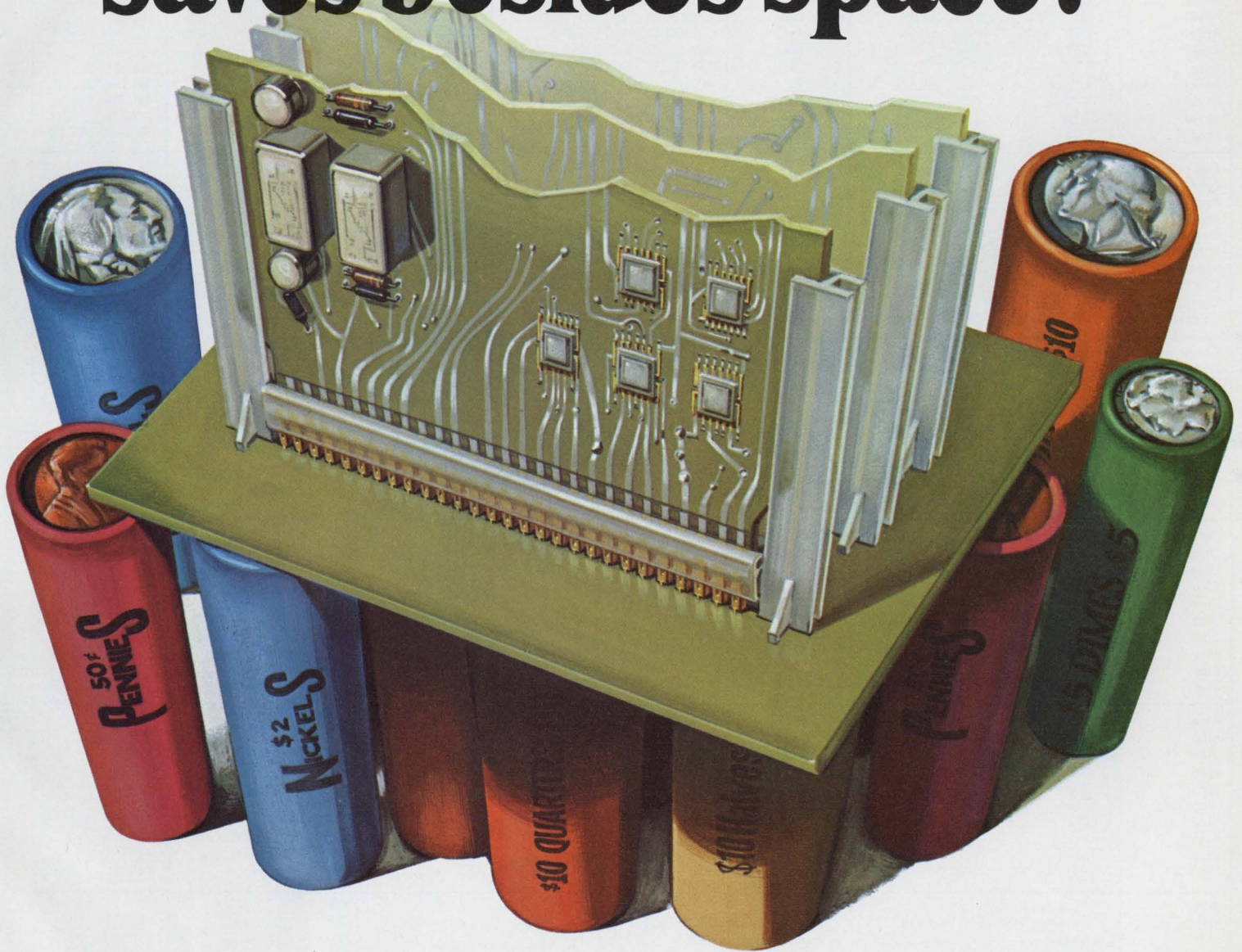

That's right. This new connector takes up very little space. For very little money.

You can choose from four different centerline spacings. Two of them—.100" and .125"—nobody else makes. And the other two—.150" and .156"—with *bifurcated* contacts—are the same spacings as anyone else's.

But that's all that's the same. You can get from 6 to 100 contacts (by 2's) per connector. Contacts are phos-

phor bronze with gold over nickel plating on contact area, and bright tin plated solder posts. Our card guides can handle two adjacent cards at the same time. There's also the unique stand-off feature of the connector housing. It exposes the contacts so you can make electrical continuity probes without damaging the contact area.

This pre-loaded TWIN-LEAF[★] connector has proven to be adaptable to every mother-daughter board appli-

cation known. And its future applications wait only for your imagination.

For more information on how you can save money and space on all your mother-daughter board applications write to **Industrial Division, AMP Incorporated, Harrisburg, Pa. 17105.**

AMP
INCORPORATED

Connectors, PC-Board (Plug-and-Receptacle)

128

Manufacturer	Series	Contacts (Min-Max)	Contact Spacing (Mils, Min-Max)	Contact Rating (A, Min-Max)	Contact Resistance (mΩ, Min-Max)	Insulation Resistance (MΩ)	Sea-Level Test Voltage (V rms)	Notes
AMP	Amp-Blade	17-47	100-125	5	5	1000	1800	1acf
AMP	Ampmodu	16-130	100-150	5	6	5000	1200	1ahk; C
AMP	Box Contact	10-180	75-100	3	6	5000	900	1cfh
AMP	Chevron	16-64	25 offset	1	25	500	450	1f; G
AMP	Termi-Grid	17-53	100	5	2	25,000	900	1k
AirBorn	WT	1-22	100	5	5	5	1000	1efh; F
AirBorn	WTA	10-70	50-100	5	5	5	1000	1efh; F
AirBorn	WTB	10-120	50-100	5	5	5	1000	1efh; F
AirBorn	WTK	10-70	50-100	5	5	5	1000	1efh; F
Amphenol	133, 143	6-22	156	5	25	5000	1800	1df; A
Armel	AP	23	50	2	4	10 ⁵	1000	1cep; A; B; I
Armel	CP	10-12	200	7.5	2	10 ⁵	2700	1cejp; A; B; I
Armel	D	11-50	62	5	2	10 ⁵	1500	1e; A; B
Armel	DEP	11-45	50-100	3-7.5	3-10	10 ⁵	1000 min	1cdehjp; A; B; I
Armel	DEP M	11-37	100	7.5	2	10 ⁵	1500	1p; A; B; I; K
Armel	EP	7-25	125	7.5	4	10 ⁵	2250	1cejp; A; B; I
Armel	LP	50	100	7.5	4	10 ⁵	1500	1acdeh; A; B
Armel	MP	6-22	125	5	2	10 ⁵	1800	1e; A; B
Armel	TBHR	7-12	100-156	5	2	10 ⁵	1500	A; B; I
Bendix	PCB	28-80	100-150	3-7.5	30-40	5000 min	1300 min	1ac; A; B
Berg	65000	16-110	100	3	12	5000 min	1000	1c
Berg	65001	8-55	100	3	12	5000 min	1000	1c
Berg	65002	16-80	150	3	12	5000 min	1000	1c
Berg	65003	8-40	150	3	12	5000 min	1000	1c
Burndy	UPC2A	17-41	150	3	10	1000	1000	1c
Burndy	UPC2B	17-41	100	3	10	1000	1000	1c
Burndy	UPC3B	13-92	100	3	10	1000	1000	1ch
Cambion	1521, 3422	1	ina	2 min	ina	ina	ina	1p; K; R; W
Cambion	2201, 2225, 3398	1	ina	8 min	ina	ina	ina	1af; R; W
Cambion	3230, 3393, 3394, 3703, 3889	1	ina	0.5 min	ina	ina	ina	1f; R; W
Cambion	3308, 3388, 3704	1	ina	2 min	ina	ina	ina	1af; R; W
Cambion	3722	1	ina	ina	ina	ina	ina	1cf; R; W; Z
Cambion	3888	1	ina	8 min	ina	ina	ina	1p; K; R; W
Cambion	7004	1	ina	ina	ina	ina	ina	1f; R; W; Z
Cambion	450-3268	1	ina	ina	ina	ina	ina	1f; R; W; Z
Cinch	Miniature 213/212	23	100 offset	7.5	4	105	2400	1e; A; I
Cinch	Standard 213/211	36	125	7.5	4	105	2400	1f; B; I
Continental	145-5	5-41	100	5	5 max	>5000	2400	1def; A; B
Continental	600-70	4-28	156	5	5 max	>5000	1650	1ef; A; B
Dale	300	7-25	250	7.5	ina	ina	2700	1ef
Dale	303	45	50	3	ina	ina	900	1ef
Dale	315	50	200	7.5	ina	ina	1875	1ef
Dale	320	7-23	156	7.5	ina	ina	1875	1ef
Elco	5004	1-44	200	10	6	5000	2500	1g
Elco	5006, 5007, 5009	12-26	200	10	6	25,000	2500	1cgh
Elco	5023	14-33	200	10	6	5000	2500	1ach
Elco	5030	15	156	10	6	25,000	2000	1cgh
Elco	7008	17-47	100	10	6	25,000	2000	1cgh
Elco	7009	24-40	100	10	6	25,000	1800	1g
Elco	7015	17-59	100	10	6	25,000	2000	1ach
Elco	7020	51	100	10	6	25,000	1800	1cgh
Elco	7024	17-41	100	10	6	25,000	1800	1cgh
Elco	7028	135	100	10	6	5000	1000	1h
Elco	7029	75-123	100	10	6	5000	2000	1h
Elco	7036	17	100	10	6	5000	1800	1g
Elco	7038	17-47	100	10	6	25,000	1800	1ach
Elco	8129	6-15	100	5	6	25,000	1350	1c
Elco	8218	2-152	50	5	6	25,000	1000	1c
Elco	8300	1-40	50	3	6	5000	1000	1c
IEH	Hypertac HGM12	12	100	3	2.5 max	5000	ina	1efp
IEH	Hypertac HGM74	74	100 offset	3	2.5 max	5000	ina	1b
IEH	Hypertac HGM100	100	100 offset	3	2.5 max	5000	ina	1h
ITT	UBS4	2-130	100	3	10	5000	1000	1ch
ITT	UBS6	2-86	150	3	10	5000	1000	1ch
3M Co.	3346, 3378, 3402, 3418, 3422, 3426, 3722, 3724	20-50	50	1	ina	ina	1500	1c; P; X
Masterite	Spade/Tuning-Fork	4-300	100-200	3	6	5000	1000	1fh; A; B
Methode	20, 22, 24	36-44	125-156	7	10	1000	1000	1g; B; Z
Methode	40, 42	17-51	100 offset	7	10	1000	1000	1ch; A
Methode	60, 61, 62, 63, 65	6-48	156	7	10	1000	1000	1df; A; B; Y
Methode	64	32	140	7	10	1000	1000	1f; A; Y
Methode	70, 71, 80, 81, 90, 91, 92	6-48	156	7	10	1000	1000	1dfh; A; B; Z
Methode	84	12-44	125-156	7	10	1000	1000	1d; B; Z
Methode	176	66-72	100	7	10	1000	1000	1d; B; Z
Methode	186	14-56	150-200	7	10	1000	1000	1h; A; B; Z
Methode	188	18	150	7	10	1000	1000	1h; A; Z
Mi-Kro	P5019, P5020, T5019, T5020	1	200	1.5	<3	>10,000	1000	1c; B; Z; (1); (3); (4)
Mi-Kro	P5021, P5022, T5021, T5022	1	200	1.5	<3	>10,000	1000	1c; R; Y; (1); (3); (4)
Milross	90253	13	100	7.5 max	5	ina	1500	1e; B
National	2333, 2334	15	140	5	5	5000	1800	1fh; P

Joint guarantee.

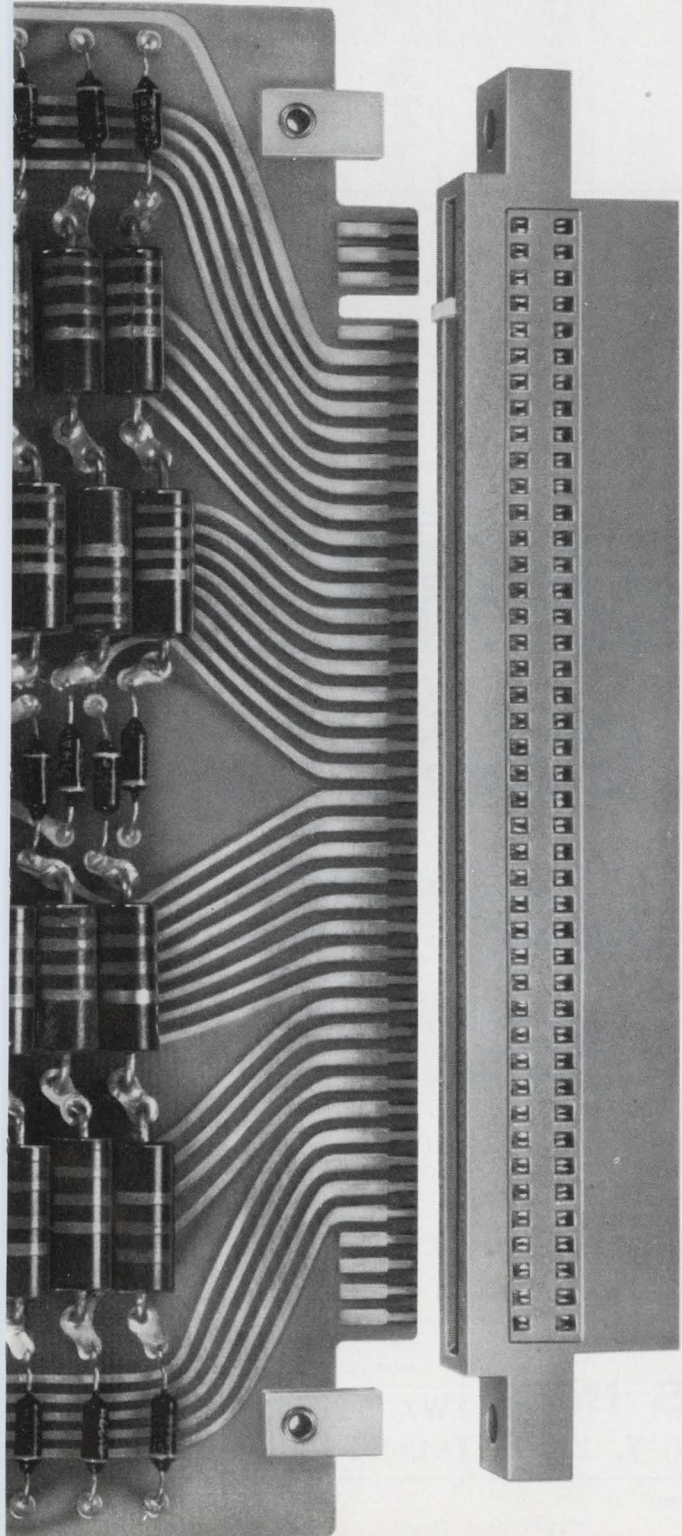

In printed circuitry, it takes two to guarantee circuit continuity and non-bridging of adjacent contacts. You and us. To cut out the guesswork (and save you a lot of expensive phone calls) we're printing this list of recommended dimensions for use with our Edge-On connectors, crimp and solder.

Connector Family	A-Contact Spacing	B	C	D	E	F-Double-Sided Board Thickness	
PA-37	.078	3.057	.123	D = C plus any whole number multiple of contact spacing	.063	.056/.069	
PA-12		.941	.040		.048		
PC4DD43-1	.156	6.785	.108		.076	.054/.072	
PC4DD36-1		5.697					
Other PC4DD	.156		.153				
PB & PBD	.100		.093			.052	.054/.072
PC4D2D	.156		.160			.092	.054/.072
PSC	.156		.160			.092	.054/.072
PSE	.050		.042			.036	.054/.072
PWC	.156		.152			.072	.054/.072

Connector Family	G	H	I	J	K	L Min.	
PA-37	±.003 x 45° ±.016	*	.095	**	**	.385	
PA-12							
PC4DD43-1			**	**	.078	.092	.330
PC4DD36-1							
Other PC4DD			*	.120	**	**	.370
PB & PBD			*	.125	.078	.089	.370
PC4D2D			**	**	.078	.101	.370
PSC			*	.051	**	**	.370
PSE			**	**	.078	.065	.370
PWC			**	**	.078	.065	.370

*H = C plus any whole number multiple of contact spacing. H should not be located in first or last position
**Not Applicable

And to meet applicable requirements of Mil C-21097, our .100" now comes in diallyl phthalate. It's impervious to chlorinated hydro-carbon but otherwise exactly like our polycarbonates — same sizes, same reliable spring contacts, same tooling and rapid installation methods. Write for samples and our new catalog #PC69.

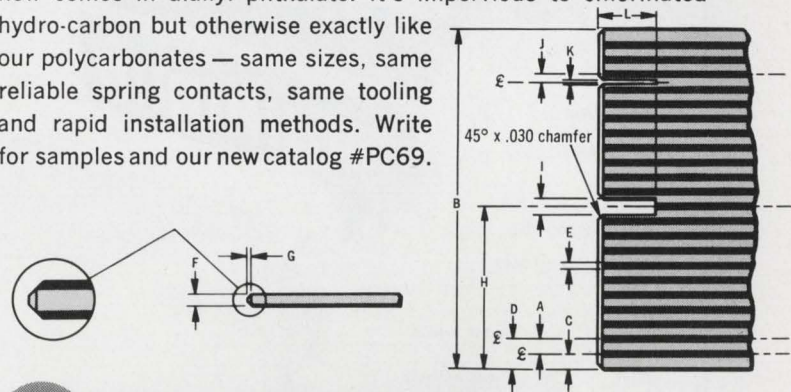

BURNDY
NORWALK, CONNECTICUT

INTERNATIONAL SALES HEADQUARTERS AND MANUFACTURING FACILITIES:
CANADA: Ontario / ENGLAND: St. Helens, Lancs.
BELGIUM: Mechelen / MEXICO: Naucalpan de Juarez / BRAZIL: Sao Paulo
JAPAN: Tokyo / Sales Offices in Other Major Cities

Manufacturer	Series	Contacts (Min-Max)	Contact Spacing (Mils, Min-Max)	Contact Rating (A, Min-Max)	Contact Resistance (mΩ, Min-Max)	Insulation Resistance (MΩ)	Sea-Level Test Voltage (V rms)	Notes
National	200219, 200220	52	150	5	5	5000 min	1800	1fh;P
National	ONO	6-55	100-125	5	5	1000	900	1f;P;Q
Sealectro	ConheX Screw-On	1	100	1.5 max	6 max	1000	1500	1c;R
Sealectro	ConheX Slide-On	1	100	1.5 max	6 max	1000	1500	1c;R
Sealectro	ConheX Snap-On	1	100	1.5 max	6 max	1000	1500	1c;R
Transitron	6040	15-37	200	5	4	5000	1800	1ef
Transitron	PE 1000	66	100	3	8.3	5000	1500	1af
U.S.C.	MIG-F, MIG-FD, MIG-M, MIG-S-M	11-37	100	7.5	4	10x10 ⁶	1060	1ef;V
U.S.C.	REPC-SGF, UPCC-SGF, UPCC-SGM	11-35	100	7.5	5	10x10 ⁶	1800	1f;T;U
U.S.C.	REPO-F, UPCC-F, UPCC-M	7-32	156	7.5	5	10x10 ⁶	1800	1bcd;fj;T;U
U.S.C.	RWG-37F, WG-37M, WG-37MR	37	100	7.5	4	10x10 ⁶	1060	1bf;U
Vero	RP16, RS16	16	ina	5 max	ina	>10 ¹²	800 V dc	
Vero	RP24, RS24	24	ina	5 max	ina	>10 ¹²	800 V dc	
Vero	RP32, RS32	32	ina	5 max	ina	>10 ¹²	800 V dc	
Vector	R100	4-20	200	5	2	5000	1800	1cs
Vector	R200	9-41	100	5	2	5000	1800	1cs
Vector	R600	12-35	100-200	5	6	25,000	1000	1cg
Winchester	42	50-74	100	5	4 max	ina	ina	1f
Winchester	W	7-23	156	7.5	2.66 max	ina	ina	1ef
Winchester	WC	23	156	7.5	2.66 max	ina	ina	1a;V
Winchester	WD	11-22	100	7.5	2.66 max	ina	ina	1ef
Winchester	WM	11-35	100	7.5	3.34 max	ina	ina	1ef
Winchester	NAS	7-23	156	7.5	2.66 max	ina	ina	1ef

COMPLETE PACKAGING CAPABILITY

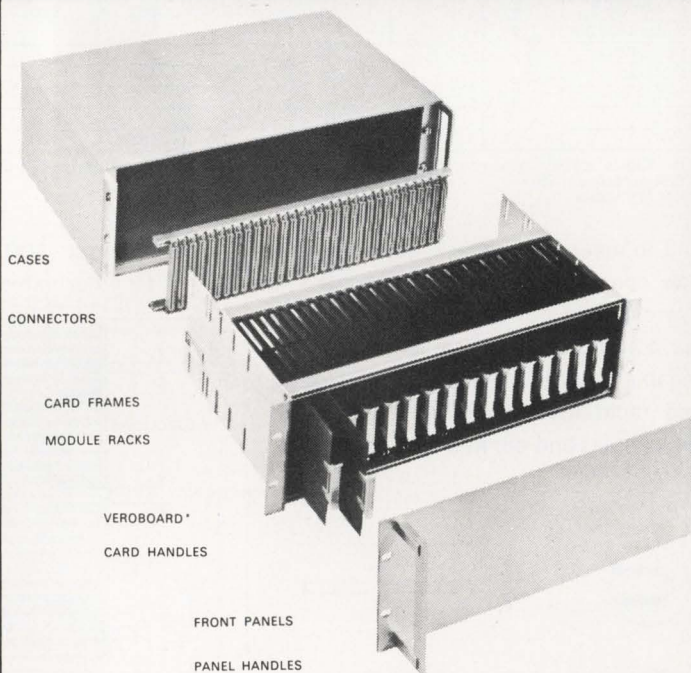

VERORACK 3 The ULTIMATE PC CARD FRAME

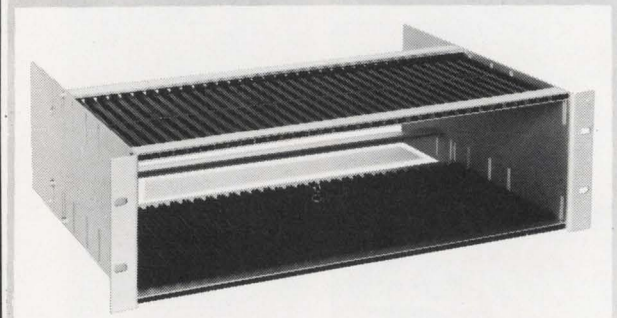

- Exceptional Strength
- Precision Aluminum Extrusion Guide Rails
- Concealed Guide Mounting
- Identification Strip Standard In Front - Optional In Rear
- Polycarbonate Guide Temp. Range -60 +125 C
- Selection of Guide Lengths
- 4" & 4½" Wide Guide Blocks With .5" Cards
- Spacing for Fastest Assembly Guides Slide Into Extrusions
- Individual Variable Spaced Guides from .4" Available
- Combine Guide Lengths for Extra Length Cards With Special Center Extrusion
- Unique Extruded Connector Rails Allow Connector Mounting at any Point and Identification of Connector Position



VERO ELECTRONICS INC. TWX 510-224-6425
176 CENTRAL AVE., FARMINGDALE, N. Y. 11735 TEL: 516 MY 4-6550

Ideas For Design

Precision voltage comparator has low power-supply drain

A simple, low-drain voltage comparator consists of a negative-resistance transistor pair, Q_3 and Q_4 , driven by a differential transistor pair, Q_1 and Q_2 . The coupling between these two pairs is also differential so that the common-mode rejection properties of the first stage are not lost. This also reduces the effects of power-supply voltage variations and drift in the constant-current source, Q_5 .

The collector resistors, R_1 and R_2 , should be matched and have low temperature coefficients. The resistors R_3 and R_4 determine the hysteresis by controlling the loop gain in the negative-resistance part of the circuit.

Diode D_1 lowers the collector voltage of Q_2 by about 0.6 V and causes triggering to occur close to zero at the input. The diode also cancels some of the temperature drift in the base-emitter diode of Q_3 and thus reduces the temperature dependence of the circuit. For the best results, D_1 and Q_3 should be in the same case. One approach is to use the base-emitter diode of another 2N930 for D_1 .

The differential pair has a specified maximum temperature drift of $10 \mu\text{V}/^\circ\text{C}$ (BCY 89, Philips) and is supplied with a current of about $15 \mu\text{A}$ from the constant-current source Q_5 . This current is determined by selecting the value of R_6 , a high-stability resistor. At $15 \mu\text{A}$ the D_1 current is $7.5 \mu\text{A}$, giving an internal resistance of about $3.3 \text{ k}\Omega$ that is compensated for by R_5 .

The output is a trigger step of about 3 V. The load must be very high impedance or an emitter-follower should be used between output and load.

The following are circuit specifications: Pow-

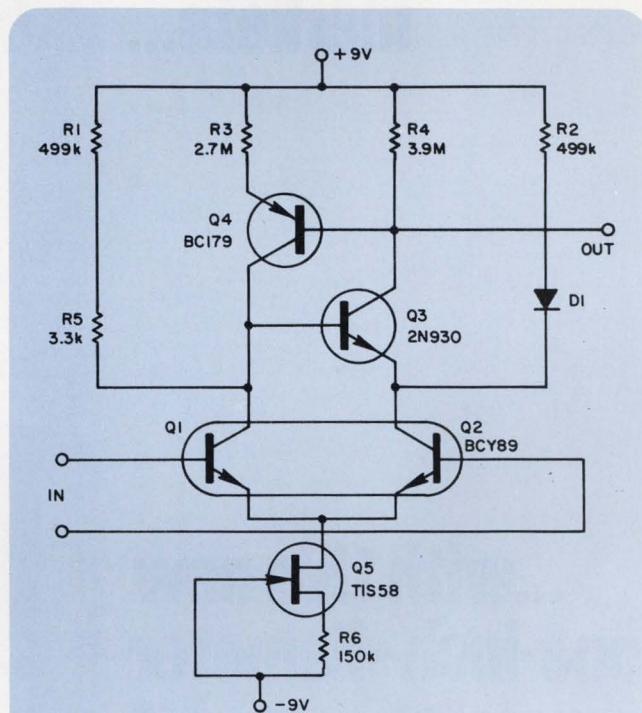

Precision comparison is achieved by a pair of transistors, Q_1 and Q_2 , used as a differential amplifier, which drive a bistable trigger circuit, Q_3 and Q_4 . Transistor Q_5 acts as a constant-current source.

er-supply requirements: ± 9 volts, $15 \mu\text{A}$; input current: 90 nA (25°C); common-mode voltage rejection: (-5 to $+3 \text{ V}$) $20 \mu\text{V}/\text{V}$; power-supply rejection: $20 \mu\text{V}/\text{V}$; total temperature drift: (25° to 75°C) $15 \mu\text{V}/^\circ\text{C}$; hysteresis: (25° to 75°C) $420 \pm 20 \mu\text{V}$.

Sverre Grimnes, Research Engineer, Department of Chemistry, University of Oslo, Postboks 1033 Blindern-Oslo 3, Norway.

VOTE FOR 311

Tunable low-cost LC oscillator has excellent stability

This tunable oscillator is very stable in both frequency and amplitude with respect to changes in temperature or supply voltage. Two outputs are available, providing almost equal voltages in phase opposition.

With proper choice of R_2 and R_3 , the distortion is less than 2% when driving a $10\text{-}\Omega$ load. Less than 2 mA are required from the power supply, and the parts cost about \$2.70, plus the

cost of the simple, untapped coil.

As the voltage on the gate of Q_2 becomes positive, the voltage at the source of Q_2 is driven more positive. This voltage is coupled through R_3 and C_2 to the source of Q_1 , turning on Q_1 and providing positive feedback to maintain oscillation. At the same time, the drain of Q_2 is being driven in a negative direction until, eventually, CR_1 begins to conduct.

**Open up
closed-circuit
markets...**

**...with this new
one-inch-diameter
Plumbicon***

*Registered trade-mark of
N.V. Philips' Gloeilampenfabrieken
Eindhoven, the Netherlands

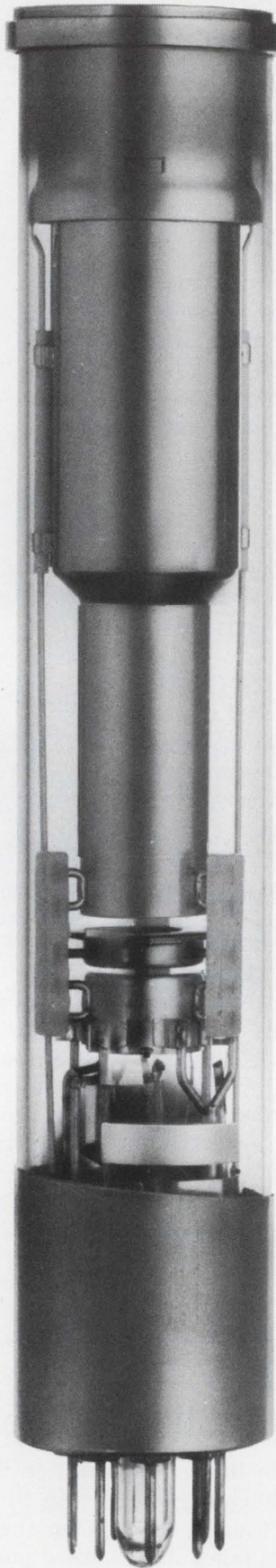

What a boost the entire CCTV industry would enjoy if existing cameras could operate well at significantly lower light levels and higher response speeds. That's exactly what this new Philips **Plumbicon** camera tube has to offer. Its one-inch-diameter makes it **retrofitable into existing cameras now using vidicons**. Developed originally to meet the exacting needs of live broadcast television, the **Plumbicon** won the industry's "Emmy" in 1967, as the year's most significant technological advance. Since then it has dominated its field - today it's in 9 out of 10 colour cameras in use throughout the world. When used in CCTV applications - in medicine, industry, education or commerce - this superb tube makes practical many applications hitherto only theoretical. The very high sensitivity, low dark current and fast response mean greatly improved picture quality - even when the subject is poorly illuminated or moving rapidly. All of which means the **Plumbicon** can make existing CCTV equipment work better, can make **CCTV colour** a practical proposition... can open up vast new markets, not only for cameras, but for related equipment as well! Let's help you open up new opportunities!

**Philips Electronic Components
and Materials Division,
Eindhoven, the Netherlands.**

Manufactured, distributed and sold
in the U.S. by
Amperex Electronic Corporation,
Electro-Optical Devices Division,
Slatersville R.I.

PHILIPS

INFORMATION RETRIEVAL NUMBER 47

FOR ACDC ELECTRONICS
REGIONAL INSERT, CIRCLE 246 ►

Our new OEM series is the best power supply you can buy for applications that don't need the best power supply you can buy.



Most OEM applications don't need all the special features we build into our best line of power supplies. And most OEM power supply users just won't pay for features they don't need. That's why we've introduced a new power supply designed especially for the OEM user.

We call it our OEM Series power supply.

There are 51 models in this new series from 4 to 32 volts and in current ranges from 0.9 to 18 amps. The OEM series offers 0.1% regulation instead of our usual 0.01% and

comes with open frame construction instead of our usual closed black box. Aside from that, you might never notice any other difference. The OEM series features the same excellent stability, same dependable overload protection, same versatile mounting capability, same "guaranteed forever" performance and same off-the-shelf delivery. The only conspicuous difference is in the price.

So now, when you don't need the best power supply that we sell, we can sell you the best power supply that you need.

acdc electronics inc.

Oceanside Industrial Center, Oceanside, California 92054, (714) 757-1880

Input	105-125 VAC, 47-63 Hz (Useable also at 400 Hz; consult factory for derating.)
Output	See table. Output is floating; either positive or negative output terminal may be grounded. Zero to full load current ratings as shown in table.
Regulation	0.1% \pm 5 mV NL-FL, \pm 0.1% \pm 5mV for 10% Input change.
Ripple	2mV RMS max., 20 mV P-P max.
Stability	Typically 10mV for eight hour period after initial warmup.
Temp. Coeff.	0.02%/°C max.
Output Impedance	DC-1KHz: 0.001 R _L or 0.005 ohm max. 1KHz-100KHz: 0.005R _L or 0.03 ohm max. (R _L is the rated load)
Transient Response	Output voltage returns to within regulation limits within 50 μ sec in response to a 50% load step.
Remote Sensing	Terminals are provided to maintain regulation at the load, compensating for the DC voltage drop in the load cable.
Remote Voltage Adjustment	Output voltage may be remotely adjusted over a limited range by insertion of a variable resistor in the positive sensing line.
Overload Protection	Inherently protected against overload and short circuit by a foldback type characteristic.
Overvoltage Protection (Optional)	Any model can be furnished with overvoltage protection which crowbars the output in the event of a rise in the output voltage of between 1 to 2 Volts or 10-20% (whichever is larger). This protection circuit is completely independent of the supply and is adjustable. The addition of overvoltage protection does not add to the outline dimensions of the supply.
Ambient Temperature	Operating: 0 to 71 °C Storage: -50 to 85 °C
Construction	Integral aluminum chassis and heatsink. Printed circuit regulator board may be removed for servicing. Three sides are open to allow unobstructed ventilation, easy inspection and accessibility.
Mounting	Units may be mounted on five surfaces for unusual mechanical versatility. Self-locking mounting hardware for all mounting variations supplied with each unit.
Connector	Barrier strip.
Dimensions	See Table Below.

DIMENSIONS				
Case Size	H	W	L	Weight Approx. (Lbs.)
R1	3 $\frac{3}{16}$	4 $\frac{1}{16}$	6 $\frac{1}{4}$	4 $\frac{1}{2}$
R2	3 $\frac{3}{16}$	4 $\frac{1}{16}$	10	7 $\frac{1}{2}$
R3	4 $\frac{1}{16}$	4 $\frac{1}{16}$	10	12

Obtain ACDC outline drawing for design and mounting details.

① NOMINAL OUTPUT VOLTAGE	ADJ. RANGE \pm V	MAXIMUM CURRENT RATING (AMPS)			CASE SIZE	MODEL NUMBER (add -1 for OVP)	PRICE③ 10-24 PIECES (Add \$10 for OVP)
		40 °C	55 °C	71 °C			
4	.25	6.0	5.1	3.9	R1	OEM4N6	59.00
		11	9.3	7.1	R2	OEM4N11	84.00
		18	15.3	11.7	R3	OEM4N18	128.00
②5	.25	5.7	4.8	3.7	R1	OEM5N5.7	59.00
		10	8.5	6.5	R2	OEM5N10	84.00
		17	14.5	11.0	R3	OEM5N17	128.00
6	.25	5.2	4.4	3.4	R1	OEM6N5.2	59.00
		9.5	8.1	6.2	R2	OEM6N9.5	84.00
		15	12.7	9.7	R3	OEM6N15	128.00
8	.25	4.2	3.6	2.7	R1	OEM8N4.2	59.00
		7.5	6.4	4.9	R2	OEM8N7.5	84.00
		12	10.2	7.8	R3	OEM8N12	128.00
10	.5	3.5	3.0	2.3	R1	OEM10N3.5	59.00
		6.5	5.5	4.2	R2	OEM10N6.5	84.00
		10.2	8.6	6.6	R3	OEM10N10.2	128.00
②12	.5	3.2	2.7	2.1	R1	OEM12N3.2	57.00
		5.8	4.9	3.8	R2	OEM12N5.8	76.00
		9.5	8.1	6.2	R3	OEM12N9.5	119.00
14	.5	2.8	2.4	1.8	R1	OEM14N2.8	57.00
		5.2	4.4	3.4	R2	OEM14N5.2	76.00
		8.7	7.4	5.6	R3	OEM14N8.7	119.00
②15	.5	2.7	2.3	1.7	R1	OEM15N2.7	57.00
		5.0	4.2	3.2	R2	OEM15N5	76.00
		8.2	7.0	5.3	R3	OEM15N8.2	119.00
16	.5	2.6	2.2	1.7	R1	OEM16N2.6	57.00
		4.7	4.0	3.0	R2	OEM16N4.7	76.00
		7.7	6.5	5.0	R3	OEM16N7.7	119.00
18	.5	2.3	1.9	1.5	R1	OEM18N2.3	57.00
		4.2	3.6	2.7	R2	OEM18N4.2	76.00
		6.9	5.9	4.5	R3	OEM18N6.9	119.00
20	1	2.1	1.8	1.4	R1	OEM20N2.1	57.00
		3.8	3.2	2.5	R2	OEM20N3.8	76.00
		6.2	5.3	4.0	R3	OEM20N6.2	119.00
22	1	1.9	1.6	1.2	R1	OEM22N1.9	57.00
		3.6	3.1	2.3	R2	OEM22N3.6	76.00
		5.9	5.0	3.8	R3	OEM22N5.9	119.00
②24	1	1.8	1.5	1.2	R1	OEM24N1.8	57.00
		3.3	2.8	2.1	R2	OEM24N3.3	76.00
		5.4	4.6	3.5	R3	OEM24N5.4	115.00
26	1	1.7	1.4	1.1	R1	OEM26N1.7	57.00
		3.1	2.6	2.0	R2	OEM26N3.1	76.00
		5.0	4.2	3.2	R3	OEM26N5.0	115.00
②28	1	1.6	1.4	1.0	R1	OEM28N1.6	57.00
		2.9	2.5	1.9	R2	OEM28N2.9	76.00
		4.7	4.0	3.1	R3	OEM28N4.7	115.00
30	1	1.5	1.3	1.0	R1	OEM30N1.5	57.00
		2.7	2.3	1.8	R2	OEM30N2.7	76.00
		4.5	3.8	2.9	R3	OEM30N4.5	115.00
32	1	1.4	1.2	0.9	R1	OEM32N1.4	57.00
		2.5	2.1	1.6	R2	OEM32N2.5	76.00
		4.3	3.6	2.8	R3	OEM32N4.3	115.00

① Contact ACDC for any voltage not listed

② In stock at ACDC (others available in 3 weeks)

③ 1-4 pcs: Add \$25

5-9 pcs: Add \$15

Contact ACDC or your local ACDC representative for higher quantity prices.

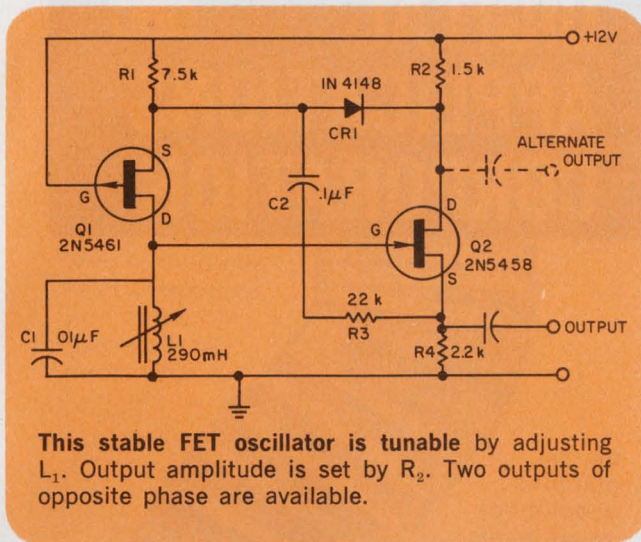

This stable FET oscillator is tunable by adjusting L_1 . Output amplitude is set by R_2 . Two outputs of opposite phase are available.

When CR_1 conducts, the feedback to Q_1 becomes negative, turning Q_1 off, and limiting the amplitude of the oscillation. The output impedance of Q_1 , operated in the grounded-gate configuration, is very high, as is the input impedance of Q_2 ; thus, the Q of the resonant circuit is kept high for excellent frequency stability.

The amount of positive feedback necessary to maintain oscillation is set by R_3 , which may vary

from a few thousand ohms for a low Q coil to more than 100 k Ω with a high Q coil. It should be set to the highest resistance that will provide reliable oscillation. The capacitance of C_2 is such that its reactance at the oscillator frequency is much less than the resistance of R_3 .

The oscillation amplitude is controlled by the resistance of R_2 , which should be set with the output load(s) applied. If a low-distortion output is desired, the amplitude must be limited so that the voltage at the gate of Q_2 does not become negative enough to cut off Q_2 completely and clip the negative peaks. However, clipping will not degrade the frequency or amplitude stability; and the resulting waveform may be preferable for some applications.

The circuit values shown are typical for a 3-kHz oscillator, producing about 1-V rms output at low distortion, using a Miller 9009 coil. Frequency shift is less than 0.01% for a 40°C change in transistor temperature. A 10% change in supply voltage causes a frequency shift of about 0.02% and an amplitude change of about 2%.

Davis E. Wilson, supervisor, support systems, Lockheed Missiles & Space Co., P.O. Box 4097, Patrick AFB, Fla.

VOTE FOR 312

Complementary transistor buffer can be used for IC interface

Interface circuits are frequently required to match IC logic outputs to load input requirements. Both amplitude and impedance must be considered. A two-transistor complementary buffer can be used to convert IC logic signals into low-impedance precision voltage signals.

The low impedance and precision amplitude are provided by a saturated transistor for both the low and high states. The idle current in the output stages is zero, with the transistors supplying current to, or sinking current from, the load on demand.

When the output of the integrated circuit is low (see drawing), transistor Q_2 is OFF and transistor Q_1 is saturated. The base current for Q_1 is determined by R_2 and R_1 . When the output of the IC is high, transistor Q_1 is OFF and transistor Q_2 is saturated. The ratio of R_2 plus R_3 to R_1 should be selected so that the base of Q_1 is greater than +5 V in this state. The IC is not required to provide base current to Q_2 .

The resistor R_5 is optional and provides short-circuit protection to ground.

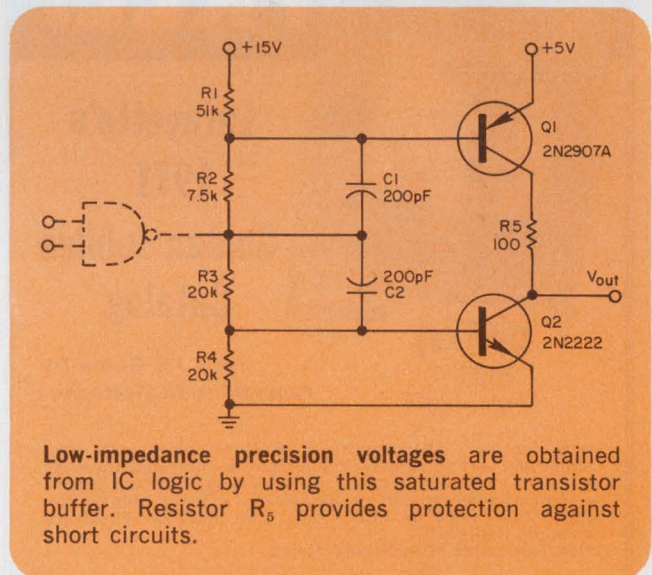

Low-impedance precision voltages are obtained from IC logic by using this saturated transistor buffer. Resistor R_5 provides protection against short circuits.

The output impedance and amplitudes are determined solely by R_{sat} and $V_{ce(sat)}$ of the transistors.

James T. Dixon III, Project Engineer, SCI Electronics, Inc., P.O. Box 4208, Huntsville, Ala. 35802.

VOTE FOR 313

(Actual Size)



Our new subminiature rotary switch ... multi-switching capability in a small package.

Flexible? 1 to 12 decks, 1 or 2 poles per deck, 2 to 10 positions per pole. Weighs 14 to 42 grams, depending on decks. Solder or printed circuit terminals available.

Tough? 50,000 operations, minimum. Makes and breaks 1/4 Amp. at 115 VAC resistive, 1/4 Amp. at 6-28 VDC resistive, 20 Ma. 115 VDC resistive, 50 Ma. 115 VAC inductive; carries 4 Amps. continuous.

For the whole story, write ...

**Arrow
Hart**

103 HAWTHORN STREET
HARTFORD, CONN. 06106

INFORMATION RETRIEVAL NUMBER 48

DIGITAL APPLICATIONS CORPORATION **dac**

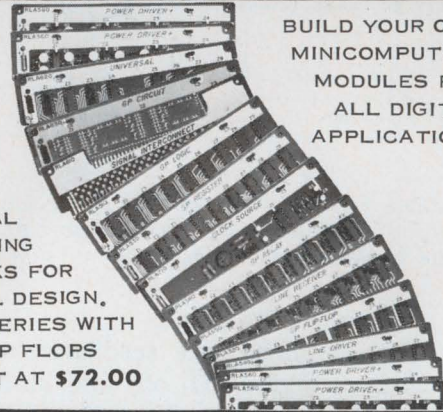

BUILD YOUR OWN MINICOMPUTER! MODULES FOR ALL DIGITAL APPLICATIONS.

DIGITAL BUILDING BLOCKS FOR TOTAL DESIGN. RLA SERIES WITH 14 FLIP FLOPS START AT \$72.00

ASK FOR OUR **FREE CATALOG TODAY**

CALL US COLLECT (213) 882-0076

dac

9168 DESOTO AVENUE
CHATSWORTH CALIFORNIA

A DIVISION OF
POWERTEC
THE POWERHOUSE

INFORMATION RETRIEVAL NUMBER 49



FREE!

Lafayette's 1971 Golden Jubilee Catalog

Your 1st Guide To Everything in Electronics

- Stereo/Hi-Fi Components • Musical Instruments and Amplifiers • Photography Equipment • Ham and CB Gear
 - Public Address Systems • Tools and Test Equipment
 - Educational and Optical Equipment • Black and White/Color Televisions • Police and Fire Monitor Receivers
 - Books and Parts
- Plus Thousands of Additional Items

Lafayette Radio Electronics, Dept. 45090
P.O. Box 10, Syosset, L.I., N.Y. 11791

Send For Your Free 1971 Lafayette Catalog Today!

Send Me the Free Lafayette Golden Jubilee 1971 Catalog 710 45090

Name

Address

City

State Zip

(Please include your zip code)

INFORMATION RETRIEVAL NUMBER 50

Shoulder and Flat Washers

FOR EVERY INSULATING PURPOSE

.. made from NYLON, TEFLON® GLASS-FILLED LEXAN and other materials.

.. hundreds of sizes and special configurations to meet the widest needs.

.. precision molded and machined to critical tolerances.

.. we can custom-make to your specifications. Write or call for free samples and complete catalog.

UNIVERSAL COMPONENTS CORPORATION

Rock Avenue & U.S. Route 22
Green Brook, N.J. 08812
Telephone (201) 968-7410

INFORMATION RETRIEVAL NUMBER 51

ELECTRONIC DESIGN 20, September 27, 1970

Remote control of a triac is made easy by using one IC

By using an IC flip-flop to control a triac, remote control of a high-power ac circuit can be easily accomplished without using any switching power at the remote switches. As the diagram shows, the switches ground either the DIRECT SET (pin 10) or DIRECT CLEAR (pin 5) input of the flip-flop. Any number of switches may be placed in parallel on either of the inputs.

When SET, the flip-flop's output (pin 6) is high and causes Q_1 to go into saturation. When saturated, Q_1 can supply sufficient gate power to drive the triac, T_1 , into the conducting state even when the ambient temperature is as low as -40°C . Resistor R_2 has been chosen large enough to limit the gate current to a safe value when Q_1 is saturated.

Although gate signals of either polarity can trigger the triac, positive voltages are used in this design because the triac is more sensitive to positive trigger signals than it is to negative trigger signals.

Lamp B₁ is used to monitor the state of the triac. It goes on when power is supplied to the load. The lamp's voltage rating should be equal to the applied ac voltage.

When CLEAR, the flip-flop's output is low, and it draws the current supplied through R_1 away from the base of Q_1 . Robbed of its base current, Q_1 turns OFF and thus allows the triac to turn OFF the next time its ac load current goes through zero.

To protect the triac against transients, R_3 and C_1 are placed across it. For 120-V applications, C_1 should have a 200-V rating; for 240-V applications, it should be rated at 400 V.

To avoid overheating, the triac should be mounted on a heat sink with a thermal resistance from the case to ambient of $2^\circ\text{C}/\text{W}$ or less. This figure assumes an ambient temperature of 25°C or less and a maximum load current of 15 A at a conduction angle of 360° . Higher ambient temperature will require lower values of thermal resistance.

A. J. Duelm, Research Engineer, Southwest Research Institute, 8500 Culebra Rd., San Antonio, Tex. 78228.

VOTE FOR 314

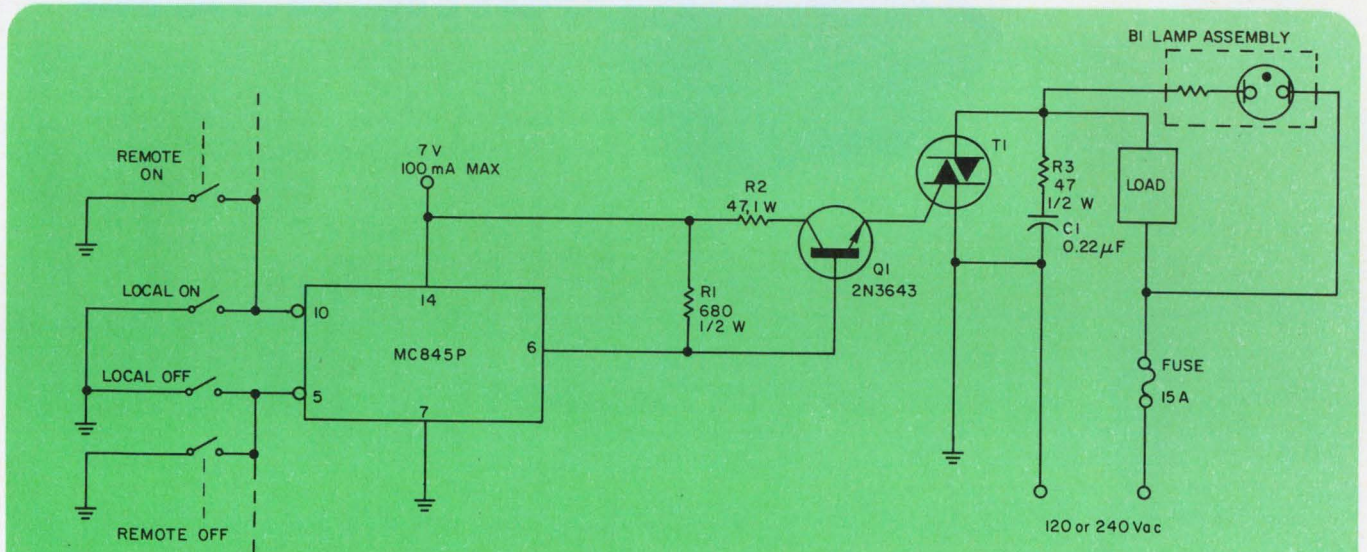

Triac T_1 will switch 3600 W of 60-Hz power at 240 V, and 1800 W at 120 V. For operation at

240 V, T_1 should be an RCA type 40576; for 120-V operation, a type 40575 will do.

Random-data generator uses only two ICs

A low-cost random-data generator for such applications as the testing of data sets can be built from only two ICs. The circuit (see drawing) generates a random sequence of bits at a rate that is set by the frequency of the externally gen-

erated square-wave signal.

ICs 1a, b and c form a free-running high-frequency oscillator. The externally generated square wave is applied to the trigger of IC 2a. At each negative edge of the square wave, the

New Helipot DAC & ADC Hybrids are MOS system compatible



Model 847 DAC & Model 871 ADC offer:

■ Integration of the best DAC/ADC functional elements from MOS/LSI, Bipolar and cermet thick-film technologies into *complete* hybrid converters.

■ MOS system compatibility (using 3750 & 3751).

■ Small, hermetic metal package & environmental specs per MIL-STD-883.

■ Resolution

■ Accuracy: (Code)
at 25°C
-20 to 85°C

■ Price (50-99 Quantity)

■ Power Consumption

MODEL 847 DAC 10 bit

D1	D2	D3
±0.025%	±0.05%	±0.1%
±0.05%	±0.1%	±0.2%
\$165.00	\$148.75	\$136.00

350mW max.

MODEL 871 ADC 12 bit

D1	D2	D3
±0.025%	±0.05%	±0.1%
±0.05%	±0.1%	±0.2%
\$252.25	\$191.25	\$165.00

950mW max.

Call your local Helipot Sales Engineering Representative for additional information and application assistance.

Beckman INSTRUMENTS, INC.

HELIPOT DIVISION FULLERTON, CALIFORNIA

INTERNATIONAL SUBSIDIARIES: AMSTERDAM; CAPETOWN; GENEVA; GLENROTHES, SCOTLAND; LONDON; MEXICO CITY; MUNICH; PARIS; STOCKHOLM; TOKYO; VIENNA

INFORMATION RETRIEVAL NUMBER 52

ELECTRONIC DESIGN 20, September 27, 1970

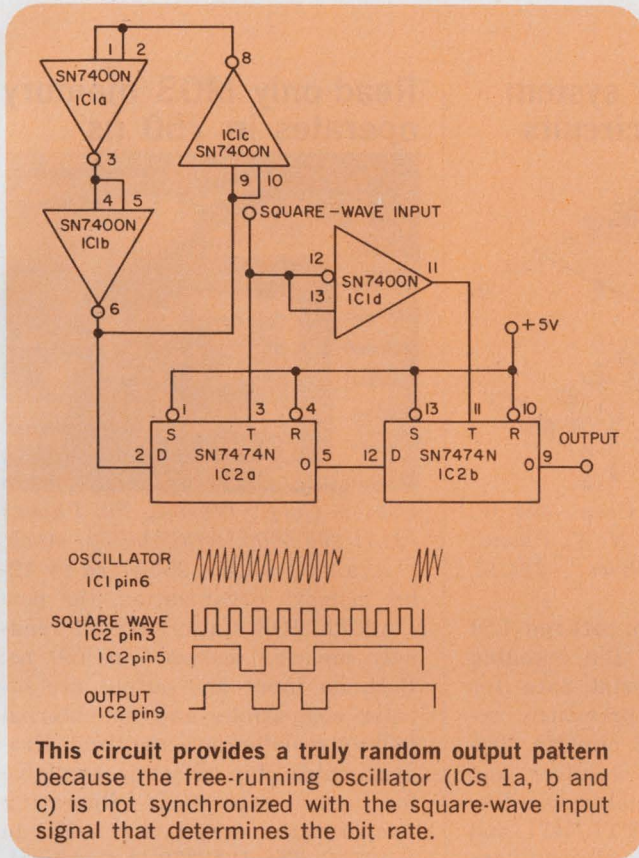

oscillator's output is transferred to the ZERO output of IC 2a and stored.

IC 1d acts as an inverter and thus transfers the oscillator's output to the ZERO output of IC 2b at each positive edge of the square wave.

IFD Winner for May 24, 1970
A. C. Burley and A. V. Aellen, Senior Engineers, Hawker Siddeley Dynamics Ltd., T.R.A.C.E. Lab., Automatic Test Equipment Dept., Napier Building, Manor Rd, Hatfield, Hertfordshire, England. Their idea "High-Frequency VCO Uses TTL Gates" has been voted the Most Valuable of Issue award.
Vote for the Best Idea in this Issue.

VOTE! Go through all Idea-for-Design entries, select the best, and circle the appropriate number on the Reader-Service-Card.

SEND US YOUR IDEAS FOR DESIGN. You may win a grand total of \$1050 (cash)! Here's how. Submit your IFD describing a new or important circuit or design technique, the clever use of a new component or test equipment, packaging tips, cost-saving ideas to our Ideas-for-Design editor. You will receive \$20 for each accepted idea, \$30 more if it is voted best-of-issue by our readers. The best-of-issue winners become eligible for the Idea Of the Year award of \$1000.

Since the free-running oscillator is not synchronized in any way with the applied square wave, the output pattern is random.

J. Renauro, Weymouth Rd., Vineland, N.J. 08360.

VOTE FOR 315

Ramp generator has adjustable retrace

This circuit produces a ramp that begins at ground level and has linear runup and linear retrace. The runup slope is proportional to R_1C , and the retrace slope is proportional to R_2C . If R_2 is replaced with a variable current source, the retrace slope is adjustable.

Low-cost plastic transistors give good performance from a slope of $0.5 \text{ V}/\mu\text{s}$ to slopes in the volts per second region. The high input impedance of Q_3 permits long gating periods to be ac-coupled, thus avoiding level translation problems.

Ralph Tenny, Equipment Tech. Master, Texas Instruments, Dallas, Tex.

VOTE FOR 316

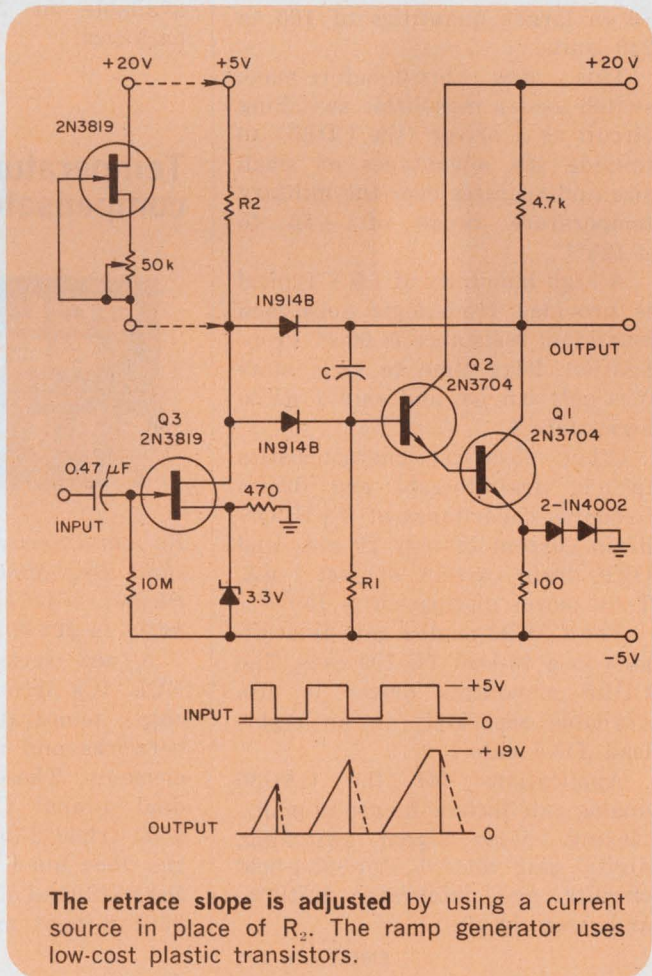

New Products

Analog gate for \$6 includes a driver

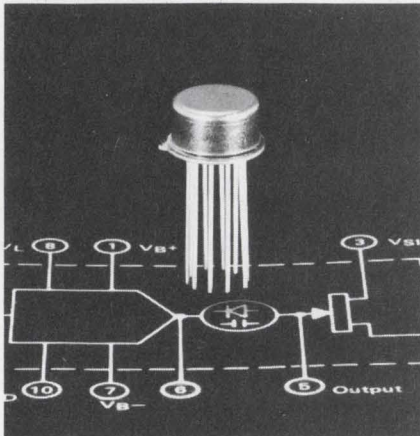

Crystalonics, a Teledyne Co., 147 Sherman St., Cambridge, Mass. Phone: (617) 491-1670. P&A: \$8.10, \$6.60; stock.

Able to switch ± 10 -V signals directly from DTL or TTL levels, the low-cost CAG30 general-purpose FET analog gate comes complete with a driver for a price of only \$8.10 in single quantities, and \$6 in larger quantities of 100 to 249 units.

This new break-before-make switch uses a monolithic switching circuit as a driver (the CDR5) to provide the advantages of small size and operates over the military temperature range of -55 to $+125^\circ\text{C}$.

A high immunity of 1.5 V typical is provided from logic noise and maximum resistance is $60\ \Omega$. Propagation delay time to logic state 0 is only $0.5\ \mu\text{s}$, and only $1\ \mu\text{s}$ to logic state 1.

Other electrical characteristics include drain-to-gate and drain-to-source capacitance of 6 pF, ON drain current of only 20 mA, and OFF drain current of just 1 nA. Total power dissipation is 75mW.

The CAG30 analog gate is available in a 10-lead TO-100 case. The CDR5 monolithic driver is also available separately in an eight-lead TO-5 case.

Applications for the CAG30 analog gate include its use in multiplexing, video signal switching, digital gain control, store-and-hold circuits and integrator initiate-and-reset circuits.

CIRCLE NO. 250

LSI 2-package system replaces 126 circuits

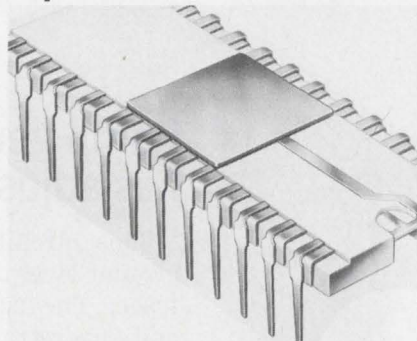

General Instrument Corp., 600 W. John St., Hicksville, N. Y. Phone: (516) 733-3333. Price: \$24.15, \$18.70.

A new unique two-package LSI system can provide the encoding and decoding of serial data for computer interface previously requiring at least 126 circuits. The AY-5-1008 terminal receiver and the AY-5-1010 terminal transmitter are compatible with TTL/DTL and MOS devices. Both devices are available in 24-lead dual-in-line packages.

CIRCLE NO. 251

Temperature-stable ICs compensate on-chip

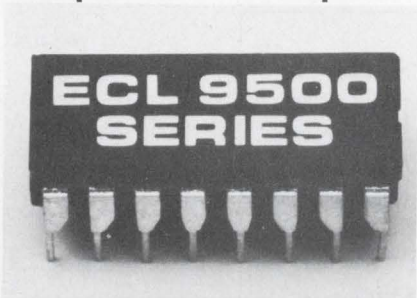

Fairchild Semiconductor, 313 Fairchild Dr., Mountain View, Calif. Phone: (415) 962-3563. P&A: \$2.95 to \$24.50; stock.

A new series of five low-cost ECL ICs incorporate unique on-chip temperature compensation networks and non-saturating gate elements. These include the 9502 dual 4-input OR/NOR gate, the 9503 triple 2-input OR/NOR gate, the 9504 quad 2-input NOR gate, the 9528 dual data flip-flop and the 9581 8-input multiplexer.

CIRCLE NO. 252

Read-only MOS memory operates in 750 ns

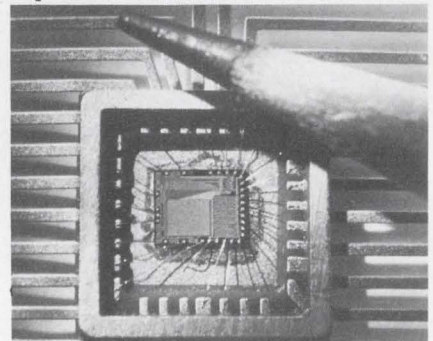

Unisem Corp., Trevose, Pa. Phone: (215) 355-5000. Availability: stock.

Available with a 256-word by 12-bit memory organization, the new UA2572 MOS static 3072-bit read-only memory accesses in 750 ns. Both its input and output are bipolar compatible, and no external pull-up resistors are required. Programmable chip select is available for easy expansion. Operating temperature range is -55 to $+125^\circ\text{C}$. The UA3572 is also available to operate from -25 to $+70^\circ\text{C}$.

CIRCLE NO. 253

Binary up/down counter clocks at 25 MHz

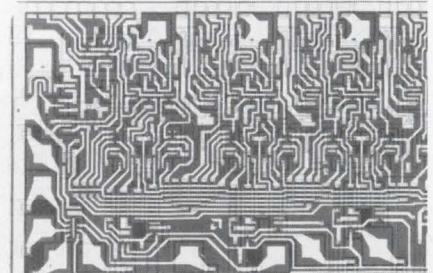

Advanced Micro Devices, Inc., 901 Thompson Pl., Sunnyvale, Calif. Phone: (408) 732-2400. Price: \$7.70.

The AM2501 is a synchronously presetable binary hexadecimal up/down counter with active pullup outputs which features a 25-MHz clock frequency. The use of input clamp diodes minimizes adverse line reflection and single-line up/down control is also available. A carry look-ahead feature allows multistage counting with no loss of speed.

CIRCLE NO. 254

Quad interface circuit steps from 5 to 12 V

Amelco Semiconductor, 1300 Terra Bella Ave., Mountain View, Calif. Phone: (415) 968-9241. P&A: \$3.80 to \$9.80; stock.

Converting 5-V logic to 12-V logic, a new quad interface operates from low-level TTL or DTL circuits to drive 12-V 40-mA outputs. The model 363 buffer is a four-circuit device with two of the circuits having expander inputs. It is designed for driving lamps or other indicators at remote locations, or as a buffer to high-noise-immunity-logic circuits.

CIRCLE NO. 255

Seven MSI TTL ICs expand 7400 line

Fairchild Semiconductor, 313 Fairchild Dr., Mountain View, Calif. Phone: (415) 962-3563. Price: \$4.10 to \$8.45.

Seven new TTL ceramic dual-in-line MSI devices expand the 7400 IC line. These are the 7480 gated full adder, the 7482 two-bit binary full adder, the 7490 decade counter and the 7491 eight-bit shift register. Also included are the 7492 divide-by-12 counter, the 7493 four-bit binary counter and the 7475 quad latch. Six are supplied in 14-pin packages. The 7475 is supplied in a 16-pin package.

CIRCLE NO. 256

MSI 256-bit memory converts alphabet codes

Signetics Corp., 811 E. Arques Ave., Sunnyvale, Calif. Phone: (408) 739-7700. Price: \$17.

A new 256-bit MSI read-only memory, organized to read 32 eight-bit words, can be wire-OR'd for operation with TTL or DTL devices. The 8224 memory is programmed to convert the seven-bit ASCII alphabet code to the eight-bit EBCDIC alphabet code and converts letters A through Z. It can convert both upper-case and lower-case letters. Propagation delay is 50 ns and power dissipation is 310 mW.

CIRCLE NO. 257

Long-term recorder records for 35 days

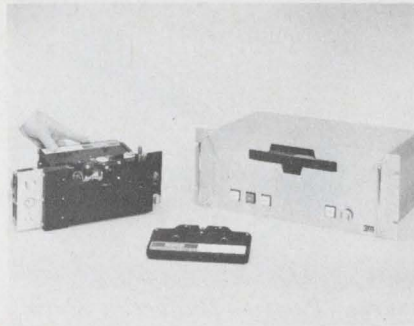

3M Co., Instrument and Data Products, 300 S. Lewis Rd., Camarillo, Calif. Price: \$3400, \$2100.

The DPM-511 is a long-term event recorder that provides up to 35 days of continuous recording on a single cartridge. Its companion DPM-521 reproducer will play back a complete cartridge in two minutes, yielding a write-to-read time-base compression of up to 25,000:1. Both use a magnetic-tape cartridge similar to the popular cassette and provide four data tracks.

CIRCLE NO. 258

Coupler/controller interfaces calculators



Hewlett-Packard, 1501 Page Mill Rd., Palo Alto, Calif. Phone: (415) 326-7000. P&A: \$1625; stock.

Communication between Hewlett-Packard desktop calculators and digital voltmeters, teleprinters and counters is provided by the 2570A coupler/controller. It allows formatted outputs with headings and labels on teleprinters. Raw measurements are processed by the calculator, displayed on its register and printed or typed out in a desired format.

CIRCLE NO. 259

Pocket-size terminal has 15-key keyboard



Fondiller Corp., 200 W. 58th St. New York, N. Y. Phone: (212) 586-6650. Price: \$1 per day for rental.

"Tape It" is a tiny 15-oz 2 by 2-1/2 by 5-in. pocket-size computer terminal with a 15-key keyboard. It can record all numbers and characters in computer code directly onto magnetic tape. It can record voice messages and has a built-in transmitter for usage with any telephone without the need of a modem.

CIRCLE NO. 260

Audio tape cassette repeats automatically

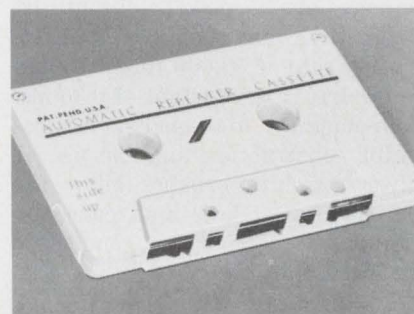

Automated Learning, Inc., 1275 Bloomfield Ave., Fairfield, N. J.

Needing no special equipment a new tape cassette operates with any recorder or player and repeats itself automatically. Simply drop the automatic repeating cassette into any player or recorder, and the recorded message will be repeated over and over automatically with true fidelity. Pre-loaded automatic repeating cassettes in lengths from 1 to 20 minutes are also available.

CIRCLE NO. 261

Silicon-target tube stores images 1 week



Sylvania Electric Products Inc., 730 3rd Ave., New York, N. Y. Availability: stock.

Using a monolithic silicon target to provide image resolution of better than 1000 lines and to provide 12 minutes of retention for gray scale and 1 hour for black and white, the new 1.5-in.-dia SP5105 storage tube holds images for over a week with its beam turned off. Its target may be scanned repeatedly without appreciable deterioration of stored information.

CIRCLE NO. 262

Variable rf capacitor withstands 5 kV

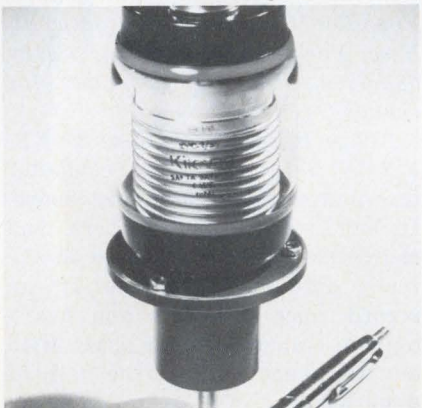

Kilovac Corp., P.O. Box 4422, Santa Barbara, Calif. Phone: (805) 963-4293.

Spanning the capacitance range of 5 to 500 pF, the KVC-2/S1 vacuum variable capacitor, developed under license from EEV Co. Ltd., has a peak rf voltage rating of 5 kV at any capacitance setting. It will carry a continuous rms current of 40 A at frequencies up to 27 MHz. Capacitance is varied by rotating a 0.25-in. shaft which covers the full capacitance range in 19 turns.

CIRCLE NO. 263

Flat pack transformer is a 0.002-in. cube

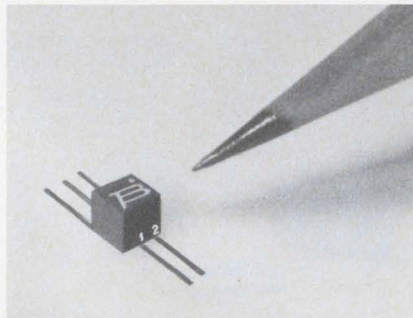

Bourns Pacific Magnetics Corp., 28151 Highway 74, Romoland, Calif. Phone: (714) 657-5195.

Model 4211-1007 is a miniature flatpack audio transformer measuring only 0.125 by 0.125 by 0.125 in. It has a frequency range of 4 to 40 kHz and a power rating of 10 mW at 20 kHz. Operating temperature range is -65 to $+105^{\circ}\text{C}$ and primary and secondary impedance is 10 k Ω . The transformer includes an electrostatic shield, a laminated core and ribbon-type leads.

CIRCLE NO. 264

One-in.-cube dc motor supplies 10-W output

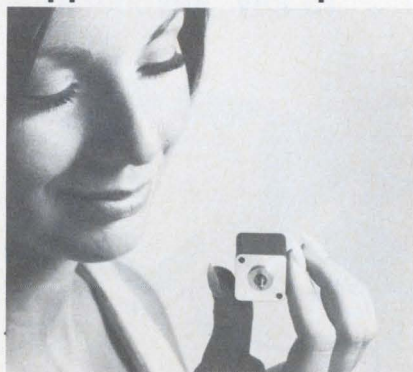

Inland Motor Corp., Radford, Va.

The NT0716 is a one-in.-cube dc torque motor rated at a peak torque of 7 oz-in. and a 10-W continuous shaft power output. It weighs less than 3 oz, has an acceleration rate of 53,000 rad/sec², and an electric time constant of 0.36 ms. Four-magnet high-energy alnico-stator construction and the use of silver graphite brushes allow for low cogging at low input currents. The rotor assembly is completely encapsulated.

CIRCLE NO. 265

Low-cost cermet trimmer has a 0.25-in. profile

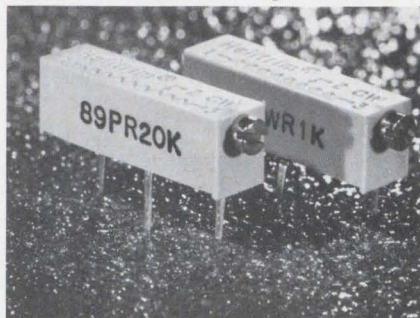

Beckman Instruments, Inc. 2500 Harbor Blvd., Fullerton, Calif. Phone: (714) 871-4848. P&A: \$1.39; stock.

Priced at \$1.35, the new series 89 15-turn cermet trimming potentiometer has a low profile of 0.25-in. high. Resistances range from 10 Ω to 2 M Ω , power rating is 0.75 W and linearity is $\pm 0.05\%$. Standard temperature coefficient is ± 100 ppm/ $^{\circ}\text{C}$ in the 100 Ω to 2-M Ω range. Special temperature coefficients of ± 50 ppm/ $^{\circ}\text{C}$ are available.

CIRCLE NO. 266

Compact 2pdt PC relay is only 0.225-in. high



Teledyne Relays, 3155 W. El Segundo Blvd., Hawthorne, Calif. Phone: (213) 679-2205. P&A: \$29.95; stock.

Reducing height above PC boards by 35%, the Centigrad series 112 two-pole double-throw relay measures only 0.225-in. high. It has a square shape of 0.137 in. to a side, and contains eight leads spaced on 0.1-in. centers. Six choices are available in coil voltages from 5 to 26.5 V dc. The Centigrad relay permits greater packaging densities on printed-circuit boards.

CIRCLE NO. 267

Monolithic op amp lowers bias to 10 nA

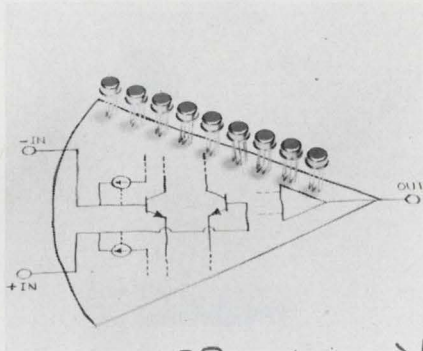

Burr-Brown Research Corp., International Airport, Industrial Park, Tucson, Ariz. Phone: (602) 294-1431. P&A: \$10; stock.

With the use of a cancellation technique, the model 3500 monolithic operational amplifier reduces its input bias current to 10 nA and thermal drift to 0.3 nA/°C. A slew rate of 1.5 V/μs is accomplished by a feedback loop that senses the instantaneous input current and supplies the appropriate compensating current.

CIRCLE NO. 268

1-in.³ active filters perform to 500 kHz

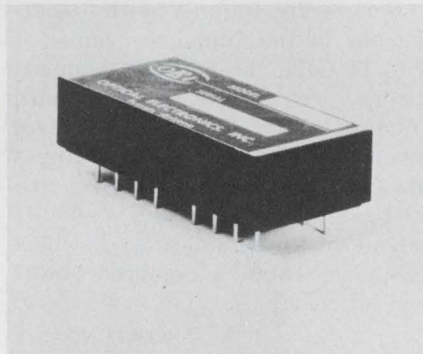

Optical Electronics, Inc., P.O. Box 11140, Tucson, Ariz. Phone: (602) 624-8358. P&A: \$87, \$189, \$295; stock.

Packaged in 1-cubic-in. modules and compatible with 0.6-in. dual-in-line sockets, the 3700 series of state-variable active filters offers independent Q and gain adjustments with performance up to 500 kHz. The 3704 (dc to 5 kHz), the 3705 (dc to 40 kHz) and the 3706 (dc to 500 kHz) have identical pin layouts.

CIRCLE NO. 269

Caption modules display 6 areas



Dialight Corp., 60 Stewart Ave., Brooklyn, N. Y.

The new series 711 caption modules provide a high degree of flexibility to numeric readouts by displaying from one to six lighted areas, either singly or in combination. The display is seen through the same viewing window as the digital portion harmoniously, and is of equal brightness. Error-free reading is possible at up to 30 feet. Incandescent lamps of 5, 6, 14 and 16 V are used.

CIRCLE NO. 270

Fast-slewing op amp settles in 0.6 μs



Dynamic Measurements Corp., 108 Summer St., Arlington, Mass. Phone: (617) 648-3610. P&A: \$37 to \$50; stock.

Featuring a maximum settling time of 0.6 μs to 0.01% of final value and a maximum recovery time from overload of 1 μs, the model FST-152 differential FET operational amplifier slews at 75 V/μs. It has a minimum dc gain of 150,000 and a common-mode rejection ratio of 10,000. The amplifier uses 6-dB/octave response shaping.

CIRCLE NO. 271

Chopper op amp slashes price to \$45

Analog Devices, Inc., 221 5th St., Cambridge, Mass. Phone: (617) 492-6000. P&A: \$45 to \$75; stock.

The model 233J chopper-stabilized operational amplifier with voltage drift of 1 μV/°C crashes the price barrier by selling for only \$45. Specifications include a 500-kHz bandwidth, 4-kHz full-power response and current drift of 2 pA/°C. Initial offset voltage is a low 50 μV. Other versions (K and L) are available with voltage drifts of 0.3 and 0.1 μV/°C, respectively.

CIRCLE NO. 272

D/a 9-bit converter works 1 million times/s

Data Technology Corp., 1050 E. Meadow Circle, Palo Alto, Calif. Phone: (415) 321-0551. P&A: \$350; 6 to 8 wks.

The model 6439 9-bit d/a converter operates glitch-free at up to 1 million conversions/second. Settling time is 500 ns and full-scale output is ±10 V into a 2-kΩ load. The new converter is packaged on a double printed-circuit board with a single-edge 44-pin connector. Overall dimensions are 4.5 by 3.33 by 0.75 in.

CIRCLE NO. 273

High-impedance op amp drives cost down to \$10

Polytron Devices, Inc., 844 E. 25 St., Paterson, N. J. Phone: (201) 523-5000. P&A: \$10; stock.

Featuring a voltage gain of 50,000, an input resistance of 10¹² Ω and offset current of 5 pA, the P201C operational amplifier costs only \$10. Other features include a voltage drift of 35 μV/°C, an output voltage of ±11 V and output current of ±5.5 mA. Gain-bandwidth product is 1 MHz (minimum), full-power output frequency is 5 kHz (minimum) and input capacitance is 4 pF.

CIRCLE NO. 274

CRT display system shows data in color

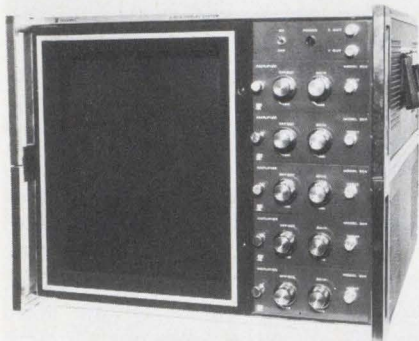

Telonic Industries, Inc., 21282 Laguna Canyon Rd., Laguna Beach, Calif. Phone: (714) 494-9401. P&A: from \$3950; 30 to 60 days.

Designated model 203, a new CRT display system provides information in full color with separate X and Y channels and 3 z-axis intensity-modulated channels (one for each color). Up to three input signals may be simultaneously displayed on its 8 by 10-in. viewing area. Input sensitivity ranges from 100 μ V/in. to 50 V/in.

CIRCLE NO. 275

Autoranging counter retails at \$1250



Monsanto Electronic Instruments, 620 Passaic Ave., W. Caldwell, N. J. Phone: (201) 228-3800. P&A: \$1250; September, 1970.

Ranging in frequency from 0.1 Hz to 20 MHz, the 107A reciprocal-taking counter with five-digit resolution retails at \$1250. It automatically displays the correct decimal point and range indication and uses a readout whose half-life is 100 years. A price of \$950, given in the Aug. 16 issue of *ELECTRONIC DESIGN*, was erroneously quoted by the manufacturer.

CIRCLE NO. 276

Phase jitter meter tests data lines

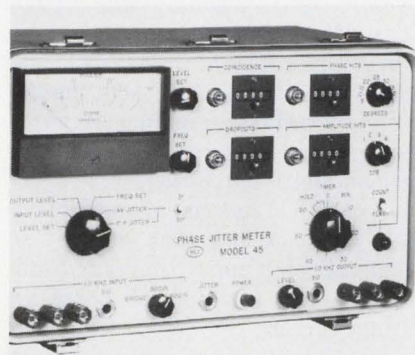

Hekimian Laboratories, Inc., 322 N. Stonestreet Ave., Rockville, Md. Phone: (301) 424-3160. P&A: \$2450 or \$2610; stock to 45 days.

A new instrument, which is available in portable or rack-mounted versions for trouble-shooting voice-frequency data communications circuits, can measure phase jitter, phase hit, gain hit and line dropouts. The model 45 phase-jitter meter checks peak-to-peak and average phase jitter up to 30 degrees with ± 1 -degree accuracy.

CIRCLE NO. 277

Digital panel meter is 0.01% accurate

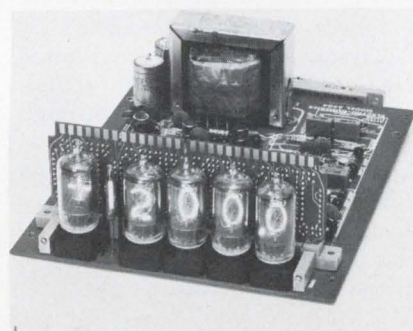

Electro-Numerics Corp., 2961 Corvin Dr., Santa Clara, Calif. Phone: (408) 738-1840. P&A: \$335; stock.

The model 3304 digital panel meter combines four digits and a 20%-over-range digit (full-scale readings of 12000), and low cost with 0.01% accuracy. Options include automatic polarity, fully buffered BCD outputs, portable battery operation, differential input, and 10 and 1- μ V resolution preamplifiers. A wide-range zero offset can suppress the meter zero up to 6000 counts.

CIRCLE NO. 278

100-mW 14-GHz impatts retail as low as \$14

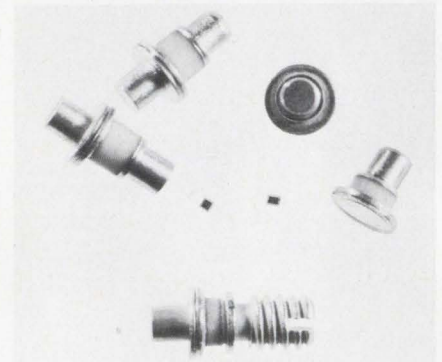

Hewlett-Packard Co., 1501 Page Mill Rd., Palo Alto, Calif. Phone: (415) 326-7000. P&A: \$14; stock.

Generating 100 mW with 3% efficiency in the frequency range of 5 to 14 GHz, the 5082-0430 impatt diodes are priced at \$14 each (quantities of 100). They are available in three frequency ranges of: 5 to 9 GHz, 8 to 12 GHz and 10 to 14 GHz. Any of the diodes can operate outside its specified frequency range at reduced power and efficiency.

CIRCLE NO. 279

Double-balanced mixer is just a TO-5 can

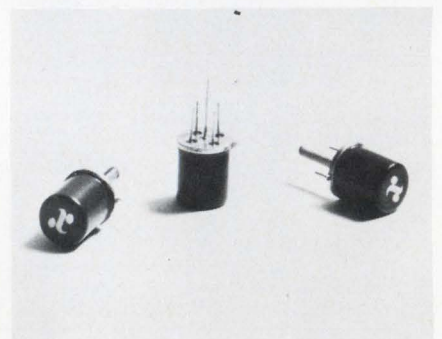

Anzac Electronics, 39 Green St., Waltham, Mass. Phone: (617) 899-1900. P&A: \$55; stock to 4 wks.

The MAC-51 is a tiny double-balanced mixer for the rf range of 2 to 500 MHz, housed in a TO-5 can. All its three ports are mutually interchangeable within their frequency ranges for large and small-signal inputs and sum and difference outputs. Isolation is 25 dB at 500 MHz and 35 dB at 50 MHz. Single-sideband conversion loss is 7 dB.

CIRCLE NO. 280

Compass for layouts doubles as calipers

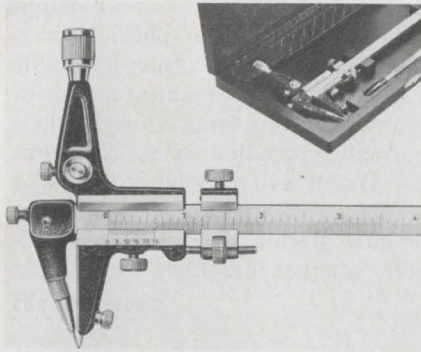

Titan Tool Supply Co., Inc., 68 Comet Ave., Buffalo, N. Y. Phone: (716) 873-9907. Price: \$36.65 to \$132.

A new compass for high-precision layout work can be accurately set directly on its own vernier scale, thus saving the time and difficulty of transferring measurements from a ruler or vernier calipers and eliminating the need for expensive layout machines. Six models range in lengths from 6 to 36 in. with diameters from 12 to 72 in.

CIRCLE NO. 281

Re-usable breadboard needs no drilling

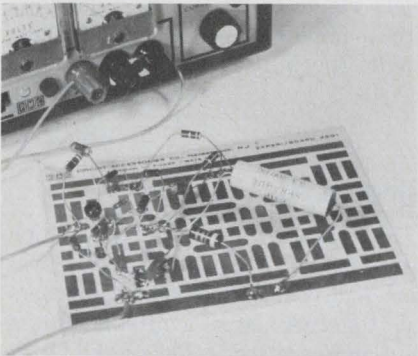

Circuit Accessories Co., Div. of Power/Mate Corp., 514 S. River St., Hackensack, N.J. Phone: (201) 343-6294. Price: \$1.95 to \$3.75.

An epoxy-fiberglass board with wide copper channels forms the new low-cost Experi/Board, re-usable breadboarding aid for engineers and experimenters. Discrete and IC components can be soldered directly to its lift-resistant copper lands with no drilling or mounting necessary. Six sizes and styles are available.

CIRCLE NO. 282

Flexible circuits can go to 200°C

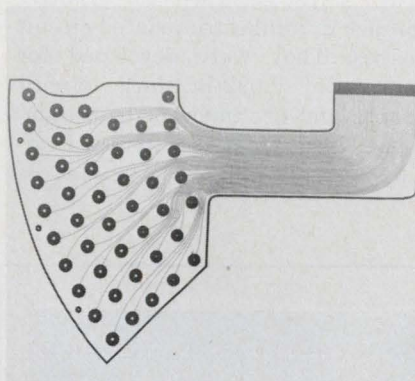

Hamby Corp., Richard Capell Co., 18376 Ventura Blvd., Tarzana, Calif.

Designed for use in extreme temperatures, new fine-line circuits on metal-clad base materials can operate from cryogenic temperatures to temperatures in excess of 200°C. Standard materials include copper, nickel, stainless and copper-nickel alloys; base materials include polyimide, epoxy glass, Mylar and Teflon. Special materials are also available.

CIRCLE NO. 283

Molded sockets accept 40-lead DIPs

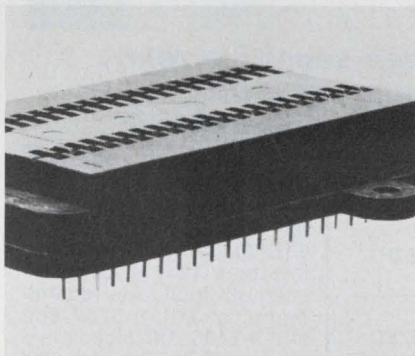

Barnes Corp., 24 N. Lansdowne Ave., Lansdowne, Pa. Phone: (215) 622-1525.

The 121-10 series of molded sockets can accept 24 to 40-lead dual-in-line devices. They will accept all standard MSI and LSI devices with either 0.5 or 0.6-in. spacing between rows, with 0.1-in. spacing between leads and with minimum lead length of 0.115 in. Contacts on the sockets have a wiping action against the side of the leads to assure positive contact.

CIRCLE NO. 284

STONEHENGE- MYSTERY SOLVED?

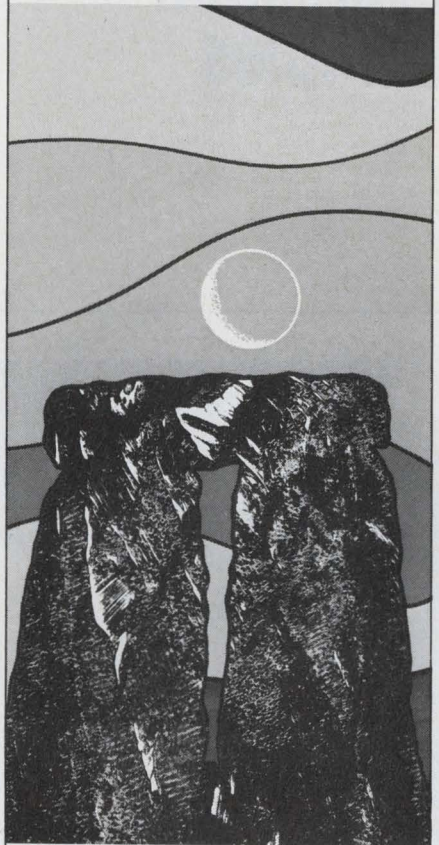

SOLVED- HOW TO PACK 100,000 pF IN A 50 MIL SQUARE CHIP CAPACITOR

Stonehenge. The enigmatic construction of giant stones, the largest of which weighs 50 tons, is now thought to be an accurate, astronomical observatory. Built by three successive races of people who came to Britain from...? We can only surmise. According to carbon dating, Stonehenge was begun about 1900 B.C. By contrast, in our age of miniaturization, ATC has solved one of the great mysteries. How to pack 100,000 pf into a 50 Mil ceramic chip capacitor. It's the ATC-300 Case "A" chip. Range: .012 MF to .1 MF. Weight: 1/10 of a grain. Your enigma solved.

BIBLIOGRAPHY

Stonehenge Decoded Gerald S. Hawkins, publ. Doubleday 1965

**American
technical
ceramics**

1 NORDEN LANE, HUNTINGTON STATION, N.Y. 11746
516/271-9600 • TWX 510-226-6993

INFORMATION RETRIEVAL NUMBER 53

Evaluation Samples

PC-board clips

The MC15 Digi-Klips are PC-board clips designed for positive contact in miniature printed-circuit boards. They were developed for use with 0.092-in.-thick circuit boards and are made of beryllium-copper heat-treated wire. A Digi-Klip mounts in two 0.021-in.-dia

holes spaced 0.3 in. apart. Normal spacing for a Digi-Klip is 0.1 or 0.156 in., but spacing of 0.078 in. is possible for high-density applications. A smooth spherical surface on each clip assures reliable contact and a burnishing action of the mating-tab connection. Each is normally supplied with a bright dip finish and can be supplied at an extra cost with tin electroplating or gold plating. Samples are available. Components Corp.

CIRCLE NO. 285

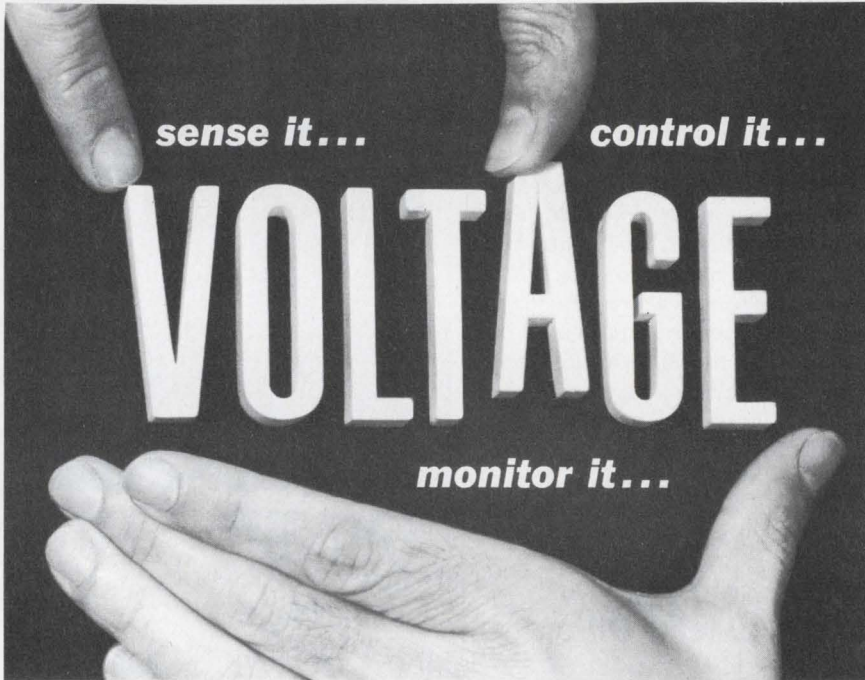

...with Tempo's new voltage-sensitive relay, designed for maximum versatility in applications where voltage is critical.

Here is a unique semiconductor device incorporating built-in signal sensing, conditioning and comparator circuits plus a relay or solid state output. It can be used for sensing and signaling an over or under-voltage condition, compared to a pre-set reference value—or, it can be utilized to operate within a pre-set voltage band, providing an output signal for alarm or load disconnection when the voltage varies from the band limits by as little as $\pm 2\frac{1}{2}\%$. Built-in hysteresis prevents output relay chatter. Models can be supplied with internal time delay to avoid false alarms

60Hz and 400Hz, 115-volt AC models are available in either 1 or 3-phase types, and are particularly suited for applications with MIL-STD-704 power systems and inverters. They meet or exceed all applicable requirements of MIL-R-5757 and MIL-R-6106. DC models are also available, for standard inputs of 28-volts or 5-volt IC supplies. The unit is packaged in a hermetically-sealed case, and is designed to operate under rugged environmental conditions, including temperatures up to 100°C.

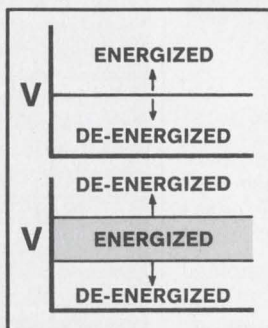

Complete tech data is yours for the asking. Send for it today, and start putting an end to your voltage problems.



Talk to Tempo When You Want to Time, Switch, Sense or Control

TEMPO INSTRUMENT DIVISION
Allen Electric and Equipment Company
PLAINVIEW, N. Y. 11803 • 516-694-4400

INFORMATION RETRIEVAL NUMBER 54

Rfi gasketing

Sticky Fingers are beryllium-copper rfi gasketing strips with adhesive surfaces that provide firm long-lasting bonds between mating surfaces. They ensure effective rfi/emi sealing and shielding between surfaces exposed to magnetic, electric, plane-wave and microwave fields. Adhesives used meet the requirements of various military specifications for exposure, water, fuel and temperature resistance, and edge, shear and peel resistance. Two test reports are available with detailed descriptions of test conditions and setups evaluating Sticky Fingers strips. In addition, a catalog showing a complete range of sizes and styles plus free samples are available. Instrument Specialties Co., Inc.

CIRCLE NO. 286

Modem ICs

Six integrated circuits which make up the heart of a modem system and cost \$39.40 when purchased together are available on a buy-and-use-first decide-later-whether-to-pay basis. The six integrated circuits are: the Motorola MC1488L quad line driver and the Motorola MC1489L quad line receiver, both which meet EIA specification RS232C; the Motorola MC1437L and MC1458G dual operational amplifiers for active filters; the Motorola MC1445G/L dual-input low-impedance frequency-shift keyer with an emitter-follower output stage; and the ultra-stable Motorola MC1550G tone generator. Schweber Electronics.

CIRCLE NO. 287

Design Aids

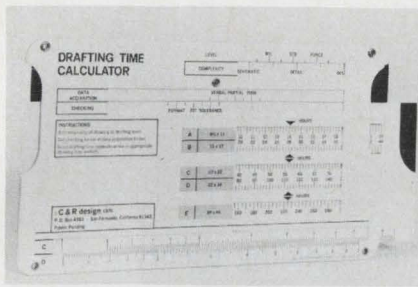

Drafting calculator

A new drafting-time calculator slide rule provides a fast and accurate method of estimating the time it takes to make an engineering drawing. Two simple settings of this new slide rule, which costs only \$5, establish parameters, delineate variables and directly convert these into hours. Adjacent to the appropriate drawing size is the estimated drawing time. A logarithmic scale is provided for multiplications of hours by dollars/hour. C&R Design.

CIRCLE NO. 288

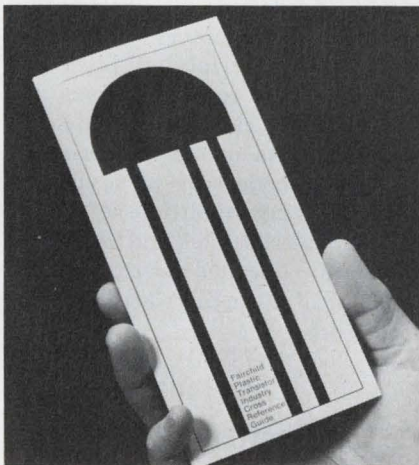

Transistors

A new transistor cross-reference guide lists the latest plastic transistors which are the nearest equivalents to more than 400 standard industry 2N types. It contains a two-color pamphlet that folds out in an accordion-like manner to form 18 panels, each measuring 7 by 3-1/2 in. In addition to the transistor listings, the names and addresses of stocking distributors are given. Fairchild Semiconductor.

CIRCLE NO. 289



There's Something New In Positioning Devices...

BRUSHLESS
WIDE ANGLE
DIRECT DRIVE
LOW COST

DC Torque Motors from Aeroflex...

Now, the maker of wide angle, high reliability, brushless DC torque motors for the critical aerospace and defense markets — Aeroflex — presents the new Valueline for commercial/industrial applications. A quality counterpart of the mil-spec Aeroflex torque motor, Valueline offers the value-engineered alternative to motor-gearhead combinations, at prices and performance criteria to meet commercial requirements.

This low cost line comes in a variety of sizes and outputs, with a direct drive design that provides space-saving packaging and simplified installation. Valueline Brushless DC Torque Motors, requiring no gear trains, offer the designer these benefits: • System simplification • High torque/power ratio • Fast response • Rapid acceleration at low speed • Low input power • Smooth, quiet output • Precise positioning • Excellent linearity • Infinite resolution • Virtually, unlimited service life.

With the Aeroflex Valueline, there's no reason to go gear train. Go direct drive at a cost savings to your systems budget. Send for the complete Valueline product performance story — VL670.



TORQUE MOTOR PRODUCTS DIVISION
AEROFLEX LABORATORIES Inc.

South Service Road, Plainview, L. I., N. Y. 11803
Tel. (516) 694-6700

WRITE
FOR
FREE
BROCHURE

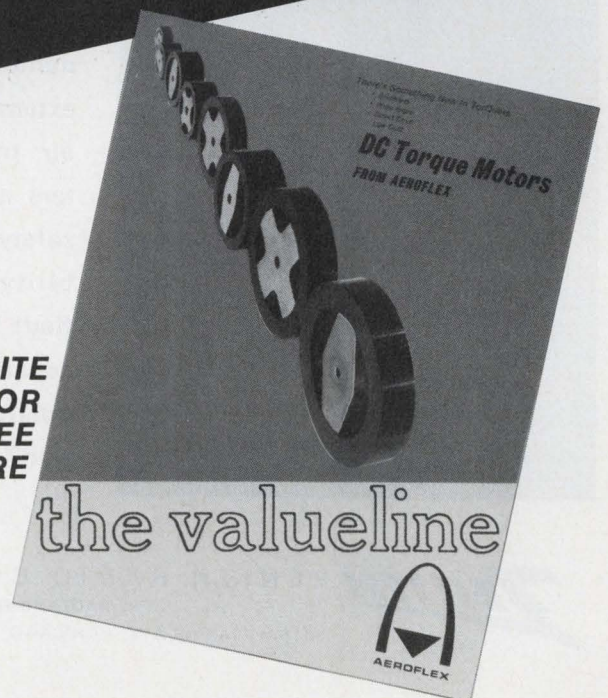

BE CAREFUL

OF FALSE ECONOMY IN DO-IT-YOURSELF A/D CONVERTERS

Most engineers recognize that high accuracy A/D converters (12 bits and up) are most economical when purchased as finished products from specialized manufacturers.

Sometimes, however, it is tempting to make converters "in-house" when lesser accuracy is required (8 or 10 bits).

This is partly because if one considers only the obvious costs (parts, assembly time, etc.) the trade-offs seem attractive. Often overlooked, however, are the "hidden costs" such as test and inventory, "de-bugging" time, calibration time, etc. Also, lead time on parts may become critical, jeopardizing an entire program.

The key, of course, is quantity. Our experience indicates that the point at which it becomes profitable to build your own converter is around 750 units per year. *For 8 or 10 bit applications, we recommend our fully calibrated, tested and guaranteed, ADC-8H or ADC-10H.* A free pamphlet suggesting some things to consider regarding in-house converter manufacturer is available from Analog Devices on request along with comprehensive data on the ADC-H series converters. Use the reader service card or contact your nearest Analog Devices Sales Office.

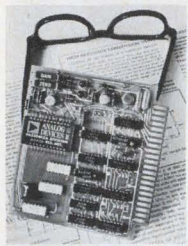

CAPSULE SPECS

Digital Control Inputs: TTL, DTL Compatible
 Analog Input Options: 0 to +10V, 0 to +5V
 0 to -10V, ±10V, ±5V
 Digital Output Options: (a) Parallel binary (TTL)
 (b) Serial binary (TTL)
 Accuracy: ±1LSB
 Size: 2" x 4" x 0.4"
 Price: (1-9) \$195. (ADC-8H), \$225. (ADC-10H)
 (10-24) \$186. (ADC-8H), \$214. (ADC-10H)



ANALOG DEVICES

PASTORIZA DIVISION
 385 Elliot St., Newton Upper Falls, Mass. 617/332-2131

INFORMATION RETRIEVAL NUMBER 56

Where reliability really counts!

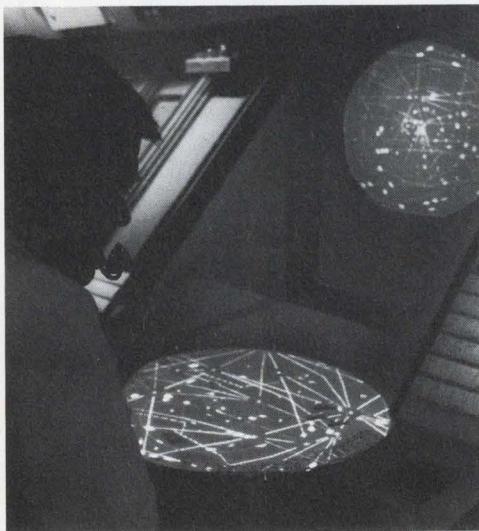

The reliability of Zenith Flat-Face Metal CRTs is demonstrated by their extensive use in enroute air traffic control centers and airports. When safety depends on reliability, Zenith is specified! Shouldn't you take advantage of Zenith CRT quality in your application? Write for details.



ZENITH RADIO CORPORATION
 THE RAULAND DIVISION
 5616 W. JARVIS AVE. • CHICAGO, ILL. 60648 • 312-647-8000

INFORMATION RETRIEVAL NUMBER 57

Application Notes

Shielding in one kind of containing or excluding EMI. Another is EMI filters.

Shielding is used to contain or exclude EMI. Another is EMI filters.

Figure 1 shows the condition of an EMI source without shielding or filtering. There are two ways of shielding the unshielded energy source from the receiver: by enclosure along wiring and cabling leaving the enclosure through shielded to direct addition system errors.

Other EMI filters are shielded (effect is the conducted interference is contained because probe de-

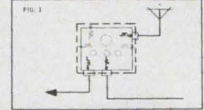
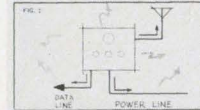
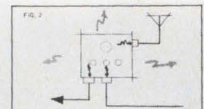

Emi shielding theory

The relationship between emi filtering and shielding is discussed and illustrated in a new twelve-page brochure. It tells why low-frequency magnetic fields and high-frequency plane-wave fields are usually the predominant shielding problems of absorption, reflection and leakage through discontinuities. A design guide for emi gaskets, derived from the presented theory, is also included. Metex Corp.

CIRCLE NO. 290

Pulse motors

A new 82-page manual covers the theory, application and maintenance of electric and electrohydraulic pulse motors. Extensive analytical material is presented with graphical representations and performance curves. Included is empirical data on the performance of eleven models of pulse motors under varying conditions of speed, torque, inertial load and other parameters. Detailed electrical and mechanical guidelines are included. Icon Corp.

CIRCLE NO. 291

Op amp settling time

Eleven pages of a sixteen-page article are devoted to a discussion of operational amplifier settling time. Reviewed is the need for amplifier settling performance of better than 0.01% of final value in 1 μ s. Linear and nonlinear factors affecting settling time are explored, and suggestions are offered for maximizing settling performance in circuits based on operational amplifiers. Graphical methods of specifying settling time are included. Analog Devices, Inc.

CIRCLE NO. 292

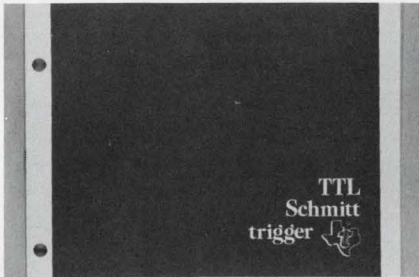

Schmitt trigger

Report CA-152 is a seven-page application report on the TTL Schmitt trigger integrated-circuit. It explains the benefits of using monolithic IC Schmitt triggers in place of discrete wired circuits. Six different applications, with circuit diagrams and operating waveforms for each, are given. Texas Instruments Inc.

CIRCLE NO. 293

Thin-films in CATV

"Two-Way Repeater Station Utilizing Hybrid Thin-Film Amplifier" is the title of a technical paper that reports on micro-electronic circuit design of hybrid thin-film push-pull integrated-circuit amplifiers. The amplifiers are for use in CATV systems repeater and two-way transmission stations. The six-page well-illustrated paper was delivered at the National Cable Television Association Convention in Chicago and was received with enthusiasm. Anaconda Electronics Co.

CIRCLE NO. 294

Stepper motors

Valuable information for the systems engineer and designer is contained in a 40-page guide which reviews the theory of operation of stepper and control motors. It describes motor excitation, selection factors, applications, and includes a glossary of stepper motor terms. The guide is complete with illustrations, diagrams, tables and useful formulas. A separate section contains a catalog of stepper motors with their electrical and mechanical specifications, performance curves, dimensional drawings and wiring data. IMC Magnetics Corp.

CIRCLE NO. 295

76.4% of the time EG&G will have the photodiode you need.

Nobody's perfect.

But with the introduction of a number of new photodiode types, including the SGD 040 silicon diffused photodiode, EG&G now

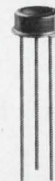

has the most complete line of photodiodes available. The low price of the new SGD 040 makes it especially suitable for OEM applications or anywhere else an inexpensive silicon photodiode is required.

All EG&G silicon diffused photodiodes feature wide spectral range, high sensitivity, fast response and low noise characteristics. Applications include CW, pulsed light and laser detection and measurement, star tracking, optical navigation, communication, guidance and range-finding systems.

Our catalog covers specification and performance details on all EG&G photodiodes. For your free copy write EG&G Inc., 170 Brookline Ave., Boston, Mass. 02215. Or call 617-267-9700.

Types	Features
Photoconductive and photovoltaic	Reliability
Bicells and quadrants	High quantum efficiency
1.06 μ detectors	Nanosecond response
Linear and matrix arrays	Low noise
Photodiode/amplifier/logic	Wide spectral range
Cooled photodiodes	Linearity
Calibrated photodiodes	Low OEM costs
Custom configurations	Diffused p-i-n structure



EG&G

ELECTRONIC PRODUCTS DIVISION

INFORMATION RETRIEVAL NUMBER 58

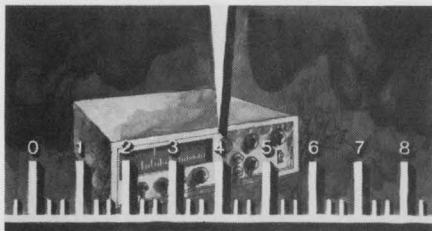

Rent- a Test

Are the instruments in your lab the latest and most accurate available? Do you have all the equipment necessary to handle peak work loads? Does it provide enough versatility to take care of special requirements? Are you able to keep it in use during a respectable portion of the 8-hour day?

If you hesitated before answering yes, maybe you should think about putting RENTAL to the test. R.E.I. gives you a wide choice of the latest equipment, precision-calibrated and in perfect working condition. You can have as much as you need, when you need it, and you can keep it only as long as you need it.

R.E.I. can give you the fastest service, the widest selection and the lowest rates of any rental firm in the country. One of our inventory centers is located near you, wherever you are, for instant delivery. Let us tell you more about the many advantages of renting vs. buying. Send today for your free copy of the new R.E.I. Instrument Rental Handbook.

Amplifiers	Filters	Power Supplies
Analizers	Generators	Recorders
Attenuators	Meters	Sources
Bridges	Oscillators	Stroscopes
Cameras	Oscilloscopes	Synthesizers
Counters	Plug-In Units	Test Chambers
Detectors	Generator/Synchronizer	

INSTANT INSTRUMENTS FROM THESE INVENTORY CENTERS:

Waltham, Mass. 02154

69 Hickory Drive
(617) 891-7610—Telex 923472

Anaheim, Calif. 92801

159 East Freedom Ave.
(714) 879-0561—Telex 655473

Gaithersburg, Md. 20760

16600 Oakmont Ave.
(301) 948-0620—Telex 898446

Rosemont, Ill. 60018

5607 Pearl St.
(312) 671-2464—Telex 726488

Ft. Lauderdale, Fla. 33308

4808 N.E. 10th Ave.
(305) 771-3500—Telex 51-4467



Dallas, Texas 75207

1341 Crampton St.
(214) 638-4180
Telex 732617

MORE INVENTORY CENTERS COMING SOON

Rental Electronics inc.

A PEPSICO LEASING COMPANY

New Literature

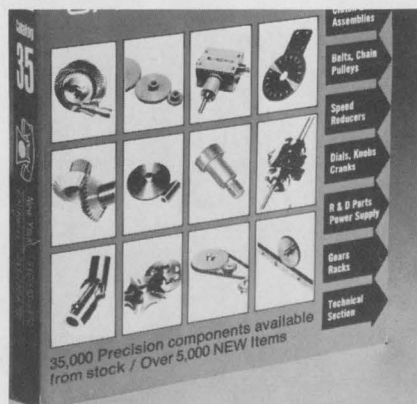

Components

Over 5000 new precision mechanical components are among the 35,000 components listed in this 446-page catalog with an easy-to-use thumb index to identify groups of similar components. A comprehensive technical section is included providing information about design and performance of precision components. PIC Design Corp.

CIRCLE NO. 296

Electronic hardware

Just issued, a 32-page catalog lists all specifications of a complete line of standard component holders, clips, circuit-board holders and other electronic hardware. Special sizes and shapes required for unusual applications are discussed. Atlee Corp.

CIRCLE NO. 297

Relays

"Technical Data TR-3" describes an entire line of miniature reed-type relays including several new types, and gives electrical and mechanical specifications. Thermo-sen, Inc.

CIRCLE NO. 298

Plug-in IC hardware

A 32-page catalog describes logic hardware, software and wiring services for plug-in dual-in-line integrated circuits. Electronic Engineering Co. of Calif.

CIRCLE NO. 299

Power conditioning

The 20-page "Power Conditioning Data Handbook and Product Index" booklet contains theoretical and practical descriptions of basic power-conditioning concepts, comparisons (with graphs and charts) and a delineation of products available utilizing standard engineering techniques. Wannlass Electric Co.

CIRCLE NO. 340

ICs and semiconductors

A complete line of integrated circuits and semiconductors for hybrid microelectronic fabricators is detailed in a catalog. These include the related advanced products of a number of manufacturers. Semiconductor devices, digital and analog integrated circuits and memory networks are covered. Starnetics Co.

CIRCLE NO. 341

54/74 ICs

A 52-page publication gives descriptions of 54/74 integrated circuits including information about electrical characteristics, logic diagrams, and pin configuration. Recommended operating conditions are also indicated. The brochure is abundantly illustrated, with 20 pages of diagrams and schematic drawings showing test circuits and voltage waveforms. Fairchild Semiconductor.

CIRCLE NO. 342

PC drafting aids

This 20-page catalog contains thousands of shapes, patterns and conductor line tapes for use in the production of precision PC master artwork layouts. Features include donuts, tees, elbows, universal corners, teardrops, ovals, connector contacts, spaced integrated-circuit pad sets and registrations marks. By-Buk Co.

CIRCLE NO. 343

Sweep generators

A 72-page catalog outlines specifications of sweep generators, rf attenuators and other related rf components. Also included is an eight page technical section explaining signal flatness, linearity, isolation and effective sweep generator measurement procedures. Texscan Corp.

CIRCLE NO. 344

Thermal instruments

A comprehensive, illustrated 20-page bulletin covering a complete line of thermal instruments and systems is now available. The bulletin contains six pages of thermal and solar-energy conversion tables, a unique thermal radiation nomograph, plus numerous other charts, graphs and tables which are helpful for heat and temperature engineering. Hy-Cal Engineering.

CIRCLE NO. 345

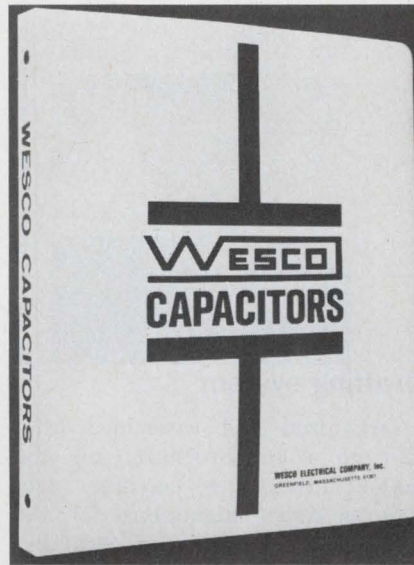

Capacitors

Film-foil and metallized capacitors are featured in a polyethylene-bound catalog. Seven product lines are described in detail and feature precision-type capacitors. Wesco Electrical Co., Inc.

CIRCLE NO. 346

Technical papers

Four technical papers are available. They include "Philosophy and design of MSI," "A comparison of solid-state subcarrier oscillators for color TV receivers," "An integrated-circuit age i-f amplifier" and "Temperature-compensated ECL." Fairchild Semiconductor.

CIRCLE NO. 347

Connectors

A 32-page fully-illustrated catalog features rack-and-panel connectors for signal and coaxial conductors with either crimp or solder contacts. Both metal-shelled and general-purpose shell-less connectors are shown along with modular-frame connectors, hood and latch hardware and hand and semi-automatic installation tooling. Burndy Corp.

CIRCLE NO. 348

CERAMIC CAPACITORS WITH SUPERIOR TEMPERATURE COEFFICIENT

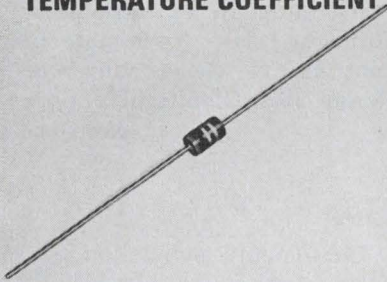

- Available in range of 0.1 to 10 picofarads.
- Tolerances of 5%-10%-20%, at rated working voltage of 500V DC.
- Temperature coefficient is $\pm 2\%$ for values of 0.1 to 5.1 pf over a temperature range of -55°C to 85°C .
- Only $\pm 3\%$ temperature coefficient for values of 5.1 to 10.0 for temperatures ranging from -55°C to $+85^\circ\text{C}$.
- Power factor less than 1% at 1 megacycle at less than 80% RH.
- Write for bulletin.

 **STACKPOLE**
CARBON COMPANY
Electronic Components Division
St. Marys, Pa. 15857

GUARANTEED UNIFORMITY IN ELECTRICAL, PHYSICAL CHARACTERISTICS

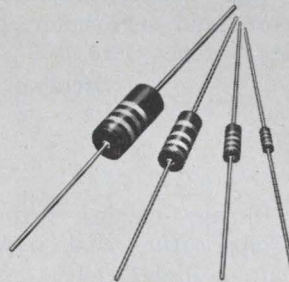

- Available in 2, 1, $\frac{1}{2}$ and $\frac{1}{4}$ watt sizes.
- Uniform from resistor to resistor, order to order.
- 100% tested for resistance value.
- Solderability, load life and humidity-temperature characteristic checked.
- Impregnated to assure moisture resistance.
- Write for literature.

 **STACKPOLE**
CARBON COMPANY
Electronic Components Division
Kane, Pa. 16735

TWO, NEW POWERFUL CERAMAG® FERRITE MATERIALS

24H
5000
PERM

24K
7500
PERM

- True 5000 and 7500 permeability ratings.
- Both 24H and 24K stay at designated perm over a wide range of sizes.
- Curie point for 24H and 24K is 175°C , typical.
- Precision engineered materials produced through exact processing, density checks and controls.
- Terrific inductance in a small size.
- Residual magnetism is 850 (24H) and 700 (24K) gauss.
- Write for data about these production materials.

 **STACKPOLE**
CARBON COMPANY
Electronic Components Division
St. Marys, Pa. 15857

SPACERS STANDOFFS

SHIPPED
SAME
DAY
FROM
STOCK

STANDARDIZED & CUSTOM
We cross Ref. most MFRS.

MIL
SPEC
PLATING &
MATERIALS

CONCORD
ELECTRONICS CORPORATION
37 GREAT JONES ST. • NEW YORK, N.Y. 10012
(212) 777-6571 TWX 710-581-4930

INFORMATION RETRIEVAL NUMBER 63



Soldering irons for every use

Specify Wallbrand for top value — choose from such "firsts" as the IDL (Instant Heat), DH (Duo Heat) and XLS (9 interchangeable elements), plus numerous other pencils, irons and guns for many metal joining jobs. All Wall products are made in U.S.A.



and
accessories



SEND FOR CATALOG I-669A

WALL MANUFACTURING CO.
Dept. ED-90 Box 3349 Kinston, N. C. 28501

INFORMATION RETRIEVAL NUMBER 64

NEW LITERATURE

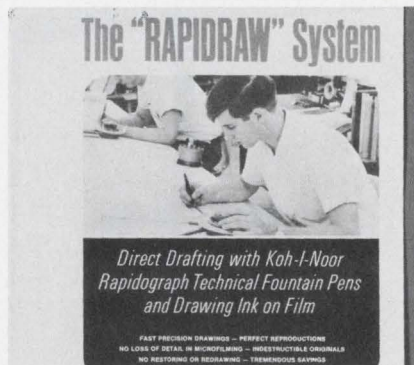

Drafting system

Organized and assembled in a 12-page color brochure, all the major advantages, savings, procedures and instructions for the "Rapiddraw" system of drafting are presented in simple, readable but highly technical form. Koh-I-Noor.

CIRCLE NO. 349

Motors

A 40-page precision motor catalog, featuring fractional-horsepower synchronous, non-synchronous, and motor gearheads for computer peripheral equipment is available. It describes induction, torque and various special non-synchronous motors, gear motors, generators, tachometers and servomotors. Instrument Systems Corp.

CIRCLE NO. 361

Filters

This 16-page catalog features general, application, and specification data on high-frequency, button-style and advanced-version filters. Also shown are performance curves and terminal configurations. The Potter Co.

CIRCLE NO. 362

Thermistors

A 32-page catalog has complete information and specifications on a comprehensive line of thermistors. The catalog contains many curves and tables, definitions and application notes. Gulton Industries, Inc.

CIRCLE NO. 363

Probes

A 12-page catalog describes over 200 probes and other special-purpose equipment used for measuring temperature, total and static pressure, velocity and flow direction of fluids, gases, and liquids at any point in a flow stream. The catalog includes photos, drawings, technical data and price lists. United Sensor and Control Corp.

CIRCLE NO. 364

CRTs

A 20-page illustrated catalog provides important data on over 100 cathode-ray tubes for industrial and military applications. The catalog is both a guide to specific cathode-ray tubes and a demonstration of capability for the design and manufacture of CRT's for special applications. Westinghouse.

CIRCLE NO. 354

Component selector

Highlighted in a 36-page short-form catalog are components including resistors, rheostats/potentiometers, trimmers, potentiometers, tap switches, variable transformers, relays, solid-state power controls, rf chokes and various design aids. Ohmite Mfg. Co.

CIRCLE NO. 355

FETs

Conveniently printed on 8-1/2 by 11-in. cards is a side-by-side listing of FET specifications and prices. A designer can quickly pick the proper FET of his choice depending on his application and budget. Siliconix Inc.

CIRCLE NO. 356

Ceramic capacitors

A 28-page full-color catalog provides specifications, performance data and application notes on chip, axial-lead tubular, radial-lead, axial-lead rectangular and radial-lead dipped capacitors. Illinois Tool Works, Inc.

CIRCLE NO. 357

Bulletin board

of product news
and developments

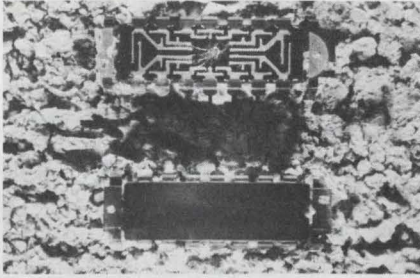

Corning Glass Works has introduced a new devitrifying **solder glass for sealing IC packages**. Designed specifically for sealing alumina ceramics, the new glass known as Code 7588 is available as a powder in a variety of mesh sizes with or without coloring additives. Sealing is accomplished at temperatures under 500° C, when used for thin seals.

In response to a petition by Micro-Link Products/Varian Solid State Div., the Federal Communications Commission has amended its rules to permit the use of a new **subscriber television service known as STV** in the 2150 to 2160-MHz band. The system consists of a traveling-wave-tube TV transmitter and a microwave down-converter for use with standard TV receivers. It can be used by anyone wishing to provide closed-circuit TV programs within a transmission radius of about 20 miles. Receivers are remotely turned on or off by means of coded signals to assure closed-circuit operation of the system.

LCAP (Linear Circuit Analysis Program) is a new computer-aided design tool for ac and dc circuit analysis. Circuits of up to 100 nodes and 400 branches can be accommodated with the new program. It performs both worst-case and Monte Carlo simulations and retains standard engineering conventions allowing an engineer with no programming experience to make use of it. LCAP contains 28 basic commands and is a development of On-Line Systems, Inc., of New York, N.Y.

CIRCLE NO. 358

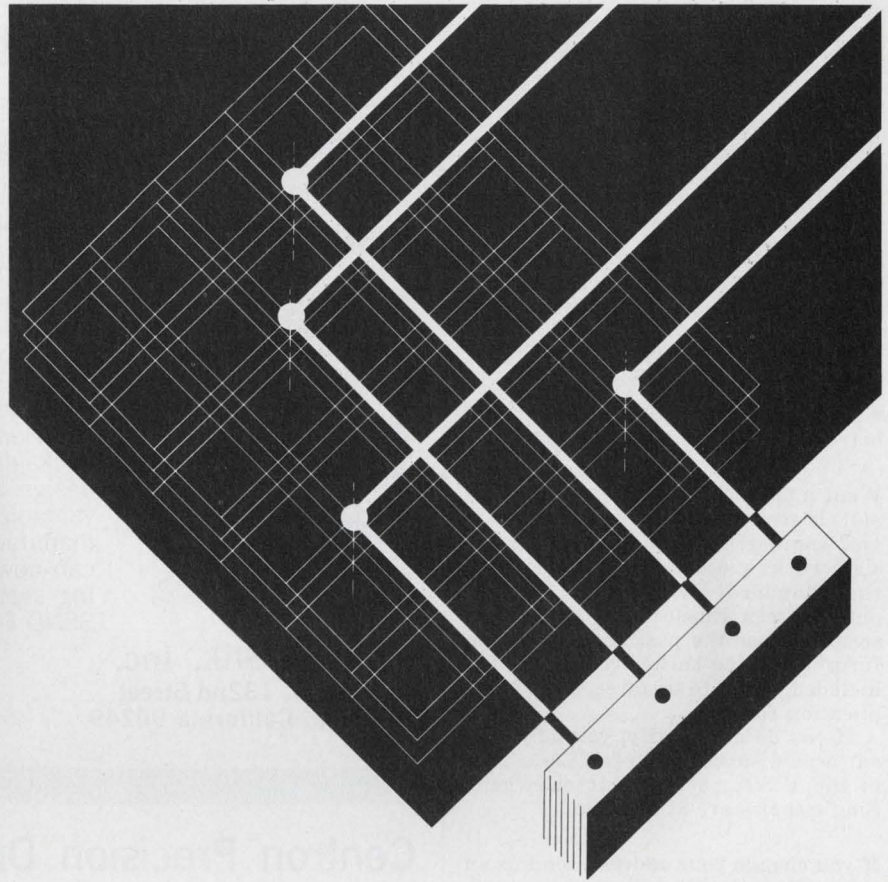

**What multi-point switch
is so reliable that more than 20 million
closures per crosspoint are common?**

The Cunningham Crossbar

This high performance, electro-mechanical switch assures long life with minimum signal distortion for the full range of switching applications—from very low voltage up to 1000 volts.

A unique contact structure is the main reason for the crossbar's reliability. Twin gold contacts, high tension, low mass and friction levels, self-wiping action... all assure superb low-level switching down to micro-volt level—at high speed.

Inherent in the crossbar design is exceptional isolation of each signal path from other paths and from the control circuits. The crossbar is not susceptible to major failure from erroneous voltages or circuit breakdown—nor to chain type failures as in solid state circuitry.

Two matrix patterns: Type A for group-to-group switching; Type F for group-to-one switching. Each covers a specific segment

of data acquisition or broadband switching and is readily programmable by every control device from tape to direct computer input.

Uses include:

- Switching video, radar and antenna signals.
- Memory and logic functions.
- Machine tool programming.
- Data acquisition systems such as outputs from strain-gages, transducers, thermocouples, component test devices, or where signal levels are in the micro-volt range.

Write or phone for Bulletin No. 130, Cunningham Corporation, 10 Carriage Street, Honeoye Falls, New York 14472. Phone (716) 624-2000.

Cunningham Corporation

SUBSIDIARY OF GLEASON WORKS

Electronic Design

ELECTRONIC DESIGN'S function is:

- To aid progress in the electronics manufacturing industry by promoting good design.
- To give the electronic design engineer concepts and ideas that make his job easier and more productive.
- To provide a central source of timely electronics information.
- To promote two-way communication between manufacturer and engineer.

Want a subscription? ELECTRONIC DESIGN is sent free to qualified engineers and engineering managers doing design work, supervising design or setting standards in the United States and Western Europe. For a free subscription, use the postfree application form inside the back cover. If none is included, write to us direct for an application form.

If you do not qualify, you may take out a paid subscription for \$25 a year in the U.S.A., \$35 a year elsewhere. Single copies are \$1.50 each.

If you change your address, send us an old mailing label and your new address; there is generally a prepaid postcard for this inside the back cover. You will have to requalify to continue receiving ELECTRONIC DESIGN free.

The accuracy policy of ELECTRONIC DESIGN is:

- To make reasonable efforts to ensure the accuracy of editorial matter.
- To publish prompt corrections whenever inaccuracies are brought to our attention. Corrections appear at the end of the Letters column.
- To refuse any advertisement deemed to be misleading or fraudulent.

Microfilm copies are available of complete volumes of ELECTRONIC DESIGN at \$19.00 per volume, beginning with Volume 9, 1961. Work is now in process to complete the microfilm edition of Volumes 1-8. Reprints of individual articles may be obtained for \$2.00 each, prepaid (\$.50 for each additional copy of the same article) no matter how long the article. For further details and to place orders, contact the Customer Services Department, University Microfilms, 300 North Zeeb Road, Ann Arbor, Michigan 48106; telephone (313) 761-4700.

Want to contact us? If you have any comments or wish to submit a manuscript or article outline, address your correspondence to:

Editor
ELECTRONIC DESIGN,
850 Third Avenue,
New York, N.Y. 10022.

Design Data from

Instant Circuit Boards!

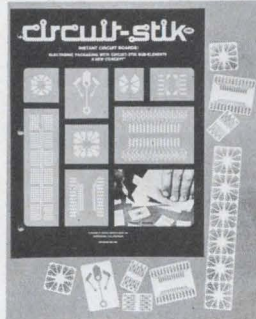

Circuit-Stik, Inc.
1518 W. 132nd Street
Gardena, California 90249

CIRCUIT-STIK'S 16 page catalog shows you how to go from schematic drawings to card cage systems — IN ONE STEP! All types of circuit-element configurations may be mixed and combined on the same board. Engineers at CIRCUIT-STIK, INC., have developed a complete family of circuit sub-elements* and circuit materials designed as a packaging system. This system will greatly reduce design and drafting expenses and save weeks of valuable schedule time normally lost to outside manufacturing services. Individual circuit boards can now be assembled and tested from engineering sketches the same day! (* Patent Pending) SEND FOR YOUR FREE CATALOG AND SAMPLES.

CIRCLE NO. 171

Centron Precision Drafting Aids Catalog

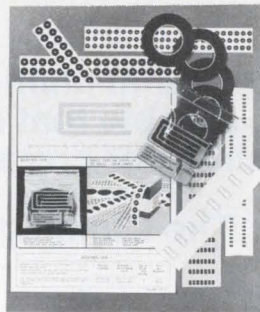

The latest catalog in pressure-sensitive precision component matched artwork symbols and drafting aids. Completely opaque pre-cut symbols are printed on pressure sensitive .0015" matte acetate film accurate to $\pm .001$ ". Featured are choices in packaging to the user which affords greater convenience and cost savings. Donut pads are offered in both roll and strip form and precision tape is packaged in air-tight zipper bags to preserve freshness even after use. SEND FOR YOUR FREE CATALOG AND SAMPLES.

CIRCLE NO. 172

Centron Engineering, Inc.
1518 W. 132nd Street
Gardena, California 90249

FUNDAMENTALS OF INTEGRATED CIRCUITS

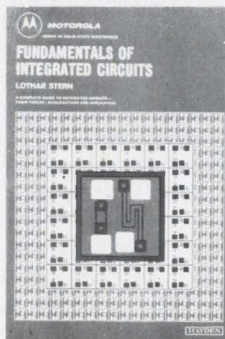

A practical guide to integrated circuits, their theory, manufacture, and applications. This new guide by Lothar Stern offers complete, highly readable coverage of the various techniques of circuit fabrication, and their effect on circuit design and performance. As to marketing considerations, it compares the characteristics of the numerous IC structures devised to date in terms of economics and logistics. A volume in the **Motorola Series in Solid-State Electronics**. 198 pages, 7 x 10, illustrated. \$8.95, clothbound. Circle the reader-service number below for 15-day examination copies.

CIRCLE NO. 173

Hayden Book Company, Inc.
116 West 14th Street
New York, N.Y. 10011

Manufacturers

Advertisements of booklets, brochures, catalogs and data sheets. To order use Reader-ServiceCard (Advertisement)

New PC Drafting Aids Catalog

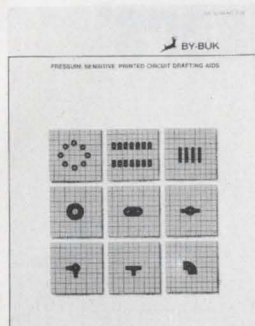

The By-Buk 1970-71 catalog of pressure sensitive printed circuit drafting aids is now available. With thousands of ideas to promote accuracy and efficiency in printed circuit master artwork layouts. Featured are new artwork patterns for: TO cans, multi-pads, dual in-lines and flat packs. Also the most comprehensive listings of conductor line tapes, pads, donuts, connector strips, elbows, corners, etc. Available in opaque black, transparent red and transparent blue materials. Send for your free catalog and samples.

By-Buk Company

4326 W. Pico Blvd.
Los Angeles, California 90019
(213) 937-3511

CIRCLE NO. 174

Minimizing Capacitance Changes



Causes of capacitance value changes in wound dielectric capacitors are treated in an Electro Cube technical bulletin to aid designers in selecting and using capacitors. Graphs and formulas are used to illustrate the straight-forward discussion and to compare performance of various dielectrics with changes in operating and environmental conditions. Also available are bulletins treating the sometimes confusing considerations of capacitor dissipation factor and insulation resistance, as part of a continuing series of two and four page technical discussions by Fred L. Johnson.

CIRCLE NO. 175

Electro Cube, Inc.
1710 South Del Mar Avenue
San Gabriel, California 91776

How To Write Technical Articles



A guide for the engineer-author, "How to Write Articles for Electronic Design" shows how easy it is to write for publication—once the engineer knows what to write and how to write it. The Author's Guide includes a complete run-down of the types of articles published by Electronic Design—plus detailed instructions on how to prepare technical articles and short special features. A MUST for every "would-be-writer" in the electronics industry. Send for your complimentary copy by circling the number to the right.

CIRCLE NO. 176

Electronic Design

850 Third Avenue
New York, N.Y. 10022

Electronic Design

Advertising Sales Staff

Keith Aldrich
Sales Manager

New York 10022

Robert W. Gascoigne
Samuel M. Deitch
Daniel J. Rowland
850 Third Avenue
(212) Plaza 1-5530
TWX: 867-7866

Philadelphia 19025

Mort Sullivan
P.O. Box 126
Dresher, Pa.
(215) 884-6880

Boston 02154

Joseph F. Palmer
1268 Main Street
Waltham, Mass.
(617) 894-2700

Chicago 60611

Thomas P. Kavooras
Berry Conner, Jr.
200 East Ontario
(312) 337-0588

Cleveland

Thomas P. Kavooras
(Chicago)
(312) 337-0588
(call collect)

Los Angeles 90303

Stanley I. Ehrenclou
W. James Bischof
2930 Imperial Highway
Inglewood, Calif.
(213) 757-0183

San Francisco 94022

Arthur R. Shields, Jr.
95 Main Street
Los Altos, Calif.
(415) 941-3084

London W. 1

For United Kingdom and Holland
Brayton C. Nichols
44 Conduit Street
Tel: REGent 4714

Verviers, Belgium

For Continental Europe
Andre Jamar
1, Rue Mallar, 1
087) 253.83 Telex 41563

Tokyo

Haruki Hirayama
Electronic Media Service
5th Floor, Lila Bldg.,
4-9-8 Roppongi
Minato-ku
Phone: 402-4556
Cable: Electronicmedia, Tokyo



HIGH DENSITY IC PACKAGING PANEL

Increase flexibility — save time, space, money

HIGH PERFORMANCE
FAST DELIVERY
LOW COST

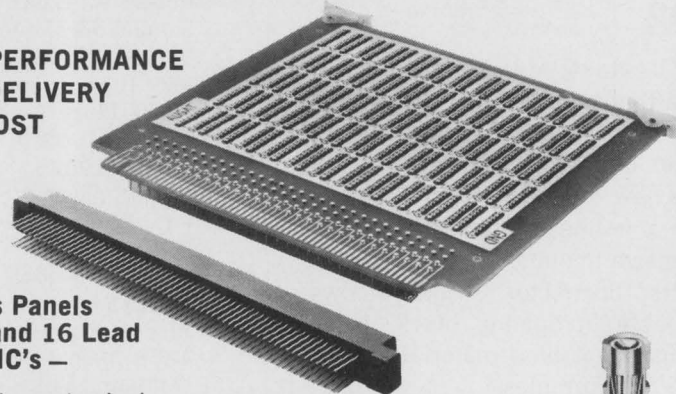

**R-Series Panels
For 14 and 16 Lead
Plug-In IC's —**

- 60 patterns standard
- Mates with Augat's new 120 contact edge connector with Wire Wrap terminations on .100 inch centers. Connector supplied separately.
- 1/8" double-sided board has power and ground planes connected to each IC pattern.
- Machined contacts assure high reliability and retention.
- Wire Wrap terminations on IC patterns.

AUGAT
INC.

Request Complete I. C. Folder
Tel: 617-222-2202
31 Perry Ave., Attleboro, Mass. 02703



INFORMATION RETRIEVAL NUMBER 70

ARITECH VOLTAGE CONTROLLED FILTERS

VCFs can help you

solve problems
in radar, telemetry, voice coding,
signal conditioning, data acquisition,
plus many other areas.

VCFs allow you to electronically shift cut-off frequency without affecting the shape of the response. They are compact, stable, and extremely reliable.

Our standard VCFs — now in stock — are 4-pole Butterworth, 24 dB/octave, either high-pass, low-pass, or band-pass.

Cut-off Frequency Range	0.1 Hz to 20 kHz
Tuning Ratio	50:1
Tuning Voltage	0 to 5 VDC
Module Size	0.75" x 2.15" x 2.15"
Quantity prices for some versions — under \$80.	

See us also for custom active filters.

ARITECH
CORP

130 Lincoln St., Brighton, Mass. 02135
Telephone: (617) 254-2990

INFORMATION RETRIEVAL NUMBER 71

Advertisers' Index

Advertiser	Page
AMP, Incorporated	61
Acopian Corporation	11
Aeroflex Laboratories, Incorporated..	79
Allco	17A
Allen-Bradley Co.	6, 7
American Technical Ceramics	77
Amperex Electronic Corporation	26
Analog Devices, Inc., Pastoriza Division	80
Aritech Corp.	88
Arrow-Hart, Inc.	68
Augat, Inc.	88
Bal-seal Engineering Co.	52
Beckman Instruments, Inc., Helipot Division	70
Boston Insulated Wire and Cable Co.	58
Burndy Corporation	63
Burroughs Corporation	22
By-Buk Company	87
Cambridge Thermionic Corporation..	52
Centron Engineering, Inc.	86
Ceramic Magnetics, Inc.	39
Circuit-Stik, Inc.	86
Concord Electronics Corporation.....	84
Cunningham Corporation	85
Dale Electronics, Inc.	Cover III
Decitek Division of Jamesbury Corp.	89
Digital Applications Corporation, A Division of Powertec	68
EG&G, Inc.	81
ENM Company	52
Electro Cube, Inc.	87
Electronic Design	18D, 87
Exact Electronics, Inc.	15
General Radio Company	1
Grant Pulley & Hardware Corporation	14
Harris Semiconductor, a Division of Harris Intertype Corporation	33, 34, 35
Hayden Book Company, Inc.	17B, 18A, 86
Hewlett-Packard	Cover II

The "no maintenance" Punched Tape Reader:

No edge guides.

No capstans, pinch rolls
or brakes.

No lenses.

No lubrication.

No adjustments.

Advertiser	Page
ISE Electronics Corporation	16
Jamesbury Corp., Decitek Division	89
Lafayette Radio Electronics	68
Molex Incorporated	25
PFC Division, Arco Electronics	90
Philips Electronics Measuring Instruments	66
Power/Mate Corp.	13
Power-Tec Division, Airtronics, Inc.	68
Qualidyne Corporation	19
RCA Electronic Components and Devices	40, Cover IV
Radiation Incorporated	33, 34, 35
Rental Electronics, Inc.	82
Schauer Manufacturing Corp.	36
Signetics Corporation	29
Singer Company, The, Electronic Products Division	53
Sprague Electric Company	20
Stackpole Carbon Company	83
TRW Semiconductor Division of TRW, Inc.	48, 49
Tektronix, Inc.	4, 5
Teletype Corporation	8, 9
Tempo Instruments Division	78
Teradyne	2
Triplett Corporation	12
Tung Sol Division, Wagner Electric Corporation	10
Universal Components Corporation..	68
Union Carbide Corporation, Components Department	18 B-C
Vero Electronics Inc.	64
Wall Manufacturing Co.	84
Zenith Radio Corporation	80

You may have to
replace this bulb
after 25,000 hours.



Simple, logical design of the new DECITEK Punched Tape Readers gives direct benefits in higher degrees of performance accuracy, greater freedom from maintenance, longer cycle life of tapes and a more economical Reader to buy.

With 20% to 30% fewer parts than units of comparable performance, DECITEK Readers start, stop and hold tape accurately in response to commands, through a stepping motor/dual sprocket bi-directional drive system. There are no edge guides or keepers to wear or damage tape, or require adjustment . . . tests with a 10' paper tape loop run at 300 cps for more than a quarter-million cycles showed insignificant sprocket hole wear.

For accurate reading of standard 5, 6, 7 or 8-level paper, paper-polyester or metallized polyester tapes, DECITEK Readers provide uniform light to all channels by 9 discrete fiber optic elements, illuminated by a single, easily replaced bulb. Crosstalk and partial or bit failure are eliminated . . . photo-transistors deliver high signal-to-noise ratio outputs. Tapes of different levels can be read interchangeably without adjustment.

Write for full details on 60- to 600-character/sec., competitively-priced DECITEK Photo-Electronic Tape Readers. DECITEK, 16 Sagamore Rd., Worcester, Mass. 01605 U.S.A. Call (617) 757-4577.



DECITEK

A DIVISION OF JAMESBURY CORP.

INFORMATION RETRIEVAL NUMBER 72

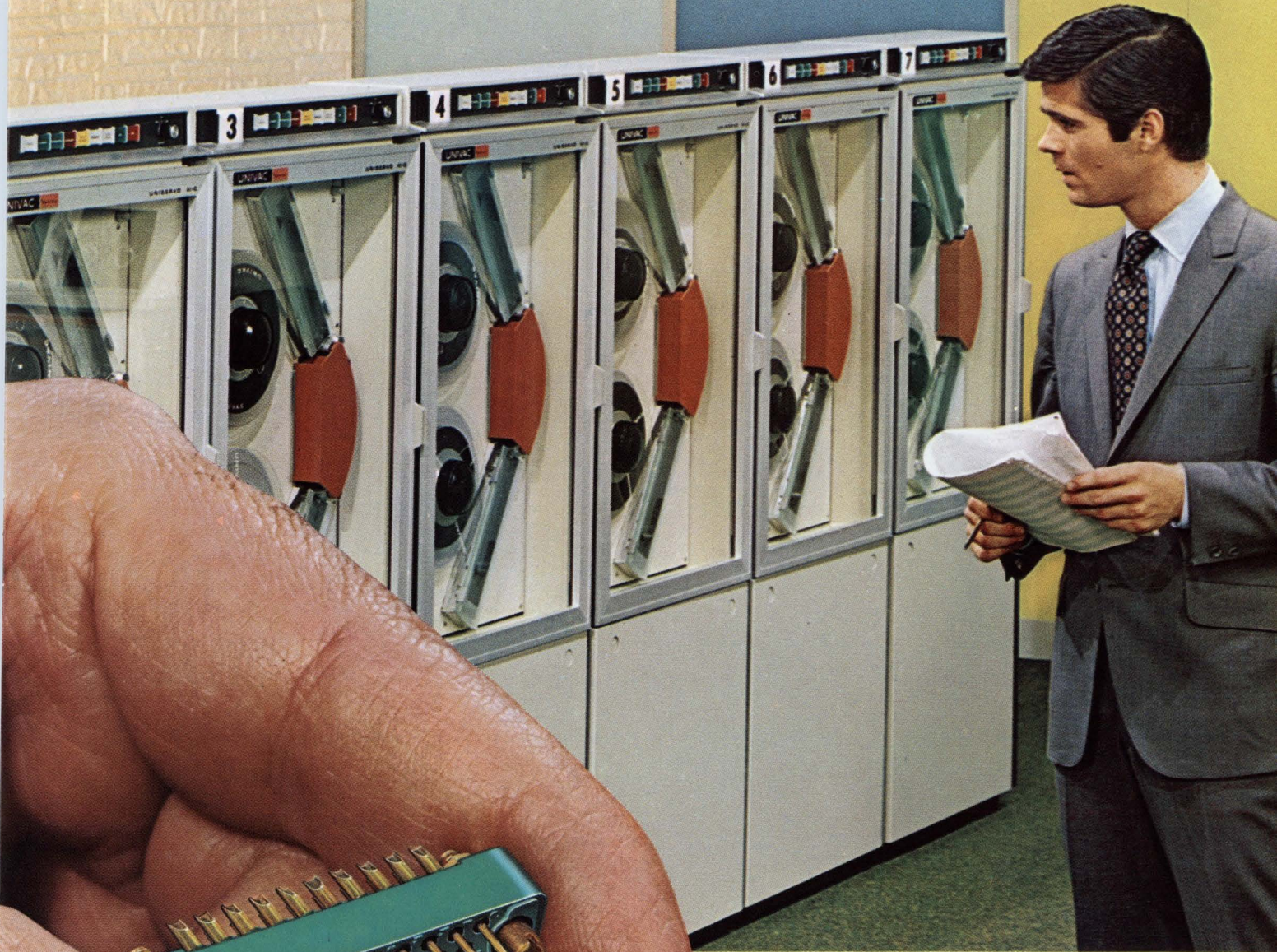

UNIVAC Servo Tape Systems rely on Dale microminiature connectors to provide a precise signal interface between magnetic heads and read/write circuits.

Dale Rack & Panel Connectors read right, write right, priced right

Critical signal transfer applications in UNIVAC Servo Tape Systems are typical of the growing uses for Dale rack and panel connectors. Available in microminiature, subminiature and miniature styles with up to 75 contacts in standard models. All use precision machined phosphor bronze contacts designed to float into easy alignment. Gold over silver plating assures good solderability, low contact resistance. Ask for details today... including Dale's very competitive price.

Phone 605-665-9301 or write for Connector Catalog.

DALE ELECTRONICS, INC.

East Highway 50, Yankton, South Dakota 57078

In Canada: Dale Electronics Canada, Ltd. • A subsidiary of The Lionel Corporation

INFORMATION RETRIEVAL NUMBER 75

DALE[®]

Take advantage of RCA's ability to supply superior SCR's and Triacs... when you need them.

Ask our solid-state specialists why RCA's broad line of industrial SCR's and triacs excel in quality, reliability, and performance. They'll tell you that RCA thyristors are subjected to some of the toughest quality assurance tests in the industry. Thus, they save design dollars by virtue of superior performance in critical applications.

Ask users of industrial thyristors why RCA is a key supplier and they'll tell you RCA services the industry! Whatever the application—area lighting to avionics, regulators to inverters, or power supplies to modulators—RCA has SCR's and triacs to meet your application requirements.

Use these SCR's and triacs in your control applications:

SCR Family	Rating		Triac Family	Rating	
	$I_T(\text{RMS})$	V_{DROM}		$I_T(\text{RMS})$	V_{DROM}
40740	10 A	600 V	40795	10 A	600 V
40752	20 A	600 V	40797	15 A	600 V
2N690	25 A	600 V	40671	30 A	600 V
2N3899	35 A	600 V	2N5443	40 A	600 V

NOTE: SCR ratings of 100, 200, & 400 volts and triac ratings of 200 & 400 volts are available in each family. Stud packages & isolated-stud packages are also available in each rating.

For further details and your copy of the latest thyristor catalog, THC-500, see your local RCA Representative or your RCA Distributor. Or write RCA Electronic Components, Commercial Engineering Section 571-27, Harrison, N.J. 07029. International: RCA, 2-4 rue du Lièvre, 1227 Geneva, Switzerland, or Post Office Box 112, Hong Kong.

RCA
Thyristors

INFORMATION RETRIEVAL NUMBER 79

