

HP 1000 M/E/F-Series Firmware

Installation and Reference Manual

The following products are covered:

HP 13304A Firmware Accessory Board
HP 12791A Firmware Expansion Module
HP 13197A Writable Control Store Board
HP 1000 E/F-Series Dynamic Mapping System
HP 12731A Memory Expansion Module
HP 13307B Dynamic Mapping Instruction Firmware
HP RTE-IV A/B Extended Memory Area Firmware
HP 13306B E-Series Fast FORTRAN Processor Firmware
HP 1000 F-Series Dynamic Mapping Instructions and
Fast FORTRAN Processor Firmware
HP 1000 F-Series Scientific Instruction Set Firmware
HP 12824A Vector Instruction Set Firmware
HP 91740B Distributed System (DS/1000) Firmware
HP 1000 E-Series Base Set and EIG/Floating Point Firmware
HP 1000 F-Series Base Set and EIG/Floating Point Firmware
HP RTE-6/VM Operating System/EMA/VMA Firmware

PRINTING HISTORY

The Printing History below identifies the Edition of this Manual and any Updates that are included. Periodically, Update packages are distributed which contain replacement pages to be merged into the manual, including an updated copy of this Printing History page. Also, the update may contain write-in instructions.

Each reprinting of this manual will incorporate all past Updates, however, no new information will be added. Thus, the reprinted copy will be identical in content to prior printings of the same edition with its user-inserted update information. New editions of this manual will contain new information, as well as all Updates.

To determine what software manual edition and update is compatible with your current software revision code, refer to the appropriate Software Numbering Catalog, Software Product Catalog, or Diagnostic Configurator Manual.

Third Edition	Jun 1981	
Fourth Edition	Nov 1981	RTE-6/VM Op Sys/EMA/VMA Firmware
Update 1	Apr 1982	ROM changes to maintain network compatibility with 91750A, DS/1000-IV
Reprint	Apr 1982	Update 1 has been incorporated.
Update 2	Dec 1982	
Reprint	Dec 1982	Update 2 has been incorporated.
Update 3	Sep 1983	Correction of Control Memory Map
Reprint	Sep 1983	Update 3 has been incorporated.

NOTICE

The information contained in this document is subject to change without notice.

HEWLETT-PACKARD MAKES NO WARRANTY OF ANY KIND WITH REGARD TO THIS MATERIAL, INCLUDING, BUT NOT LIMITED TO, THE IMPLIED WARRANTIES OF MERCHANTABILITY AND FITNESS FOR A PARTICULAR PURPOSE. Hewlett-Packard shall not be liable for errors contained herein or for incidental or consequential damages in connection with the furnishing, performance or use of this material.

Hewlett-Packard assumes no responsibility for the use or reliability of its software on equipment that is not furnished by Hewlett-Packard.

This document contains proprietary information which is protected by copyright. All rights are reserved. No part of this document may be photocopied, reproduced or translated to another program language without the prior written consent of Hewlett-Packard Company.

PREFACE

The firmware described in this manual is standard or optional firmware for the HP 1000 E/F-Series Computer. The 13304A FAB, 12791A FEM, and 13197A WCS are options for M/E/F-Series Computers. M-Series firmware options are not included in this manual, information for these can be found in the following manuals.

- a. *HP 21MX Computer Series Installation and Service Manual*, part no. 02108-90006.
- b. *HP 21MX Computer Series Reference Manual*, part no. 02108-90002.
- c. *HP 21MX Computer Series Operator's Manual*, part no. 02108-90004.
- d. *HP 21MX M-Series Computer HP 2108B and HP 2112B Operating and Reference Manual*, part no. 02108-90037.
- e. *HP 1000 M-Series Computer HP 2108B and HP 2112B Installation and Service Manual*, part no. 02108-90035.
- f. *HP 12945A M-Series User Control Store Board Installation Manual*, part no. 12945-90001.
- g. *HP 12978A M-Series Writable Control Store Board Reference Manual*, part no. 12978-90007.
- h. *HP 12976B M-Series Dynamic Mapping System Installation Manual*, part no. 12976-90005.
- i. *HP 12977B M-Series Fast Fortran Processor Installation Manual*, part no. 12977-90008.
- j. *HP 91740A M-Series Distributed System (DS/1000) Firmware Installation Manual*, part no. 91740-90007.

Additional information for E/F-Series Computers is provided in the following manuals.

- a. *HP 1000 E-Series or F-Series Operating and Reference Manual*.
- b. *HP 1000 E-Series or F-Series Installation and Service Manual*.
- c. *HP 1000 E/F-Series Computer Microprogramming Reference Manual*, part no. 02109-90001.
- d. *HP 12892A Memory Protect Installation Manual*, part no. 12892-90007.

CONTENTS

Section I	Page	Section VIII	Page
HP 13304A FIRMWARE ACCESSORY BOARD		HP 1000 F-SERIES SCIENTIFIC INSTRUCTION SET FIRMWARE	
Introduction	1-1	Introduction	8-1
Description	1-1	Description	8-1
Installation/Removal	1-3	Installation	8-1
Service Information	1-5	Verification	8-1
Section II	Page	Section IX	Page
HP 12791A FIRMWARE EXPANSION MODULE		HP 12824A VECTOR INSTRUCTION SET FIRMWARE	
Introduction	2-1	Introduction	9-1
Description	2-1	Description	9-1
Installation/Removal	2-2	Installation	9-1
Service Information	2-6	Verification	9-1
Section III	Page	Section X	Page
HP 13197A WRITABLE CONTROL STORE		HP 91740B DISTRIBUTED SYSTEM FIRMWARE	
Introduction	3-1	Introduction	10-1
Installation/Removal	3-1	Description	10-1
Programming	3-4	Installation	10-1
General Theory of Operation	3-8	Verification	10-2
Section IV	Page	Section XI	Page
HP 1000 E/F-SERIES DYNAMIC MAPPING SYSTEM		M/E/F-SERIES CONTROL MEMORY ALLOCATION	
Introduction	4-1	Control Memory Maps	11-1
Description	4-1	Section XII	Page
Installation	4-1	HP 1000 E-SERIES BASE INSTRUCTION SET AND EIG/FLOATING POINT FIRMWARE	
Verification	4-3	Introduction	12-1
Section V	Page	Description	12-1
HP RTE IV A/B EXTENDED MEMORY AREA FIRMWARE		Installation	12-1
Introduction	5-1	Verification	12-2
Description	5-1	Section XIII	Page
Installation	5-1	HP 1000 F-SERIES BASE INSTRUCTION SET AND EIG/FLOATING POINT FIRMWARE	
Verification	5-2	Introduction	13-1
Section VI	Page	Description	13-1
HP 13306B FAST FORTRAN PROCESSOR FIRMWARE		Installation	13-1
Introduction	6-1	Verification	13-2
Description	6-1	Section XIV	Page
Installation	6-1	HP 1000 E-SERIES RTE-6/VM OPERATING SYSTEM/EMA/VMA FIRMWARE	
Verification	6-1	Introduction	14-1
Section VII	Page	Description	14-1
HP 1000 F-SERIES DYNAMIC MAPPING INSTRUCTION AND FAST FORTRAN PROCESSOR FIRMWARE		Installation	14-1
Introduction	7-1	Verification	14-2
Description	7-1		
Installation	7-1		
Verification	7-1		

CONTENTS (Continued)

Section XV	Page	Appendix A	Page
HP 1000 F-SERIES RTE-6/VM OPERATING SYSTEM/EMA/VMA FIRMWARE		HP 12823F F-SERIES ENHANCEMENT UPGRADE KIT	
Introduction	15-1	Description	A-1
Description	15-1	Installation	A-1
Installation	15-1		
Verification	15-1		

HP 13304A FIRMWARE ACCESSORY BOARD

SECTION

I

1-1. INTRODUCTION

This section provides installation instructions and service information for the HP 13304A Firmware Accessory Board (FAB) which is an accessory for HP 1000 E/F-Series Computers. Installation and reference information for the various HP firmware options which can be installed on the FAB can be found in the appropriate section of this manual. Additional information is provided in the manuals listed in the preface.

1-2. DESCRIPTION

The 16,384 words of addressable control store in the HP 1000 E/F-Series Computer are divided into sixty-four 256-word modules (0 through 63). See figure 11-2 or 11-3 in section XI for the allocation of Control Memory. The computer base instruction set is not available to the user microprogrammer. Any other control store module not filled by microprogrammed Hewlett-Packard options are available to the user microprogrammer. It is recommended that the user microprogrammer only use modules which are not HP reserved or specified for HP microprogrammed options.

The HP 13304A Firmware Accessory Board (FAB) includes space for 3,584 words of addressable control memory and consists of 30 integrated-circuit (IC) sockets to accommodate up to 14 modules of control memory. These 14 modules are arranged into four addressable blocks (A, B, C, and D) of control memory. Each addressable block has its own jumper configuration which will determine its associated control memory module addresses.

BLOCK ADDRESSING

Block A (sockets A1 through A12) consists of twelve 1K (256 word by 4 bit) read-only-memory (ROM) IC's which include space for 512 words (two modules) of addressable control memory. ROM IC's to be installed in block A must be configured as two contiguous modules; e.g., modules 46 (sockets A1 through A6) and 47 (sockets A7 through A12). The least significant module (LSM) corresponds to the lower number IC sockets (A1 through A6). The most significant module (MSM) corresponds to the higher number IC sockets (A7 through A12). (See figure 1-2 and table 1-1).

Blocks B, C, and D (sockets B1 through B6, sockets C1 through C6, and sockets D1 through D6, respectively) each consist of six 4K (512 word by 8 bit) ROM IC's; each of these three blocks includes space for 1,024 words (four modules) of addressable control memory. ROM IC's to be installed in blocks B, C, or D must be configured as four contiguous modules; e.g., modules 60, 61, 62, and 63. If block B is used, the least significant module pair (LSMP) corresponds to the lower number IC sockets (B1 through B3) and the most significant module pair (MSMP) corresponds to the higher number IC sockets (B4 through B6). (See figure 1-2 and table 1-2.) Each ROM IC must be tested, burned, and verified according to the user's need, or purchased from Hewlett-Packard as an option.

PRIORITY

Control Store modules installed on the FAB assembly have lower priority than the HP 13197A Writable Control Store (WCS), the HP 12791A Firmware Expansion Module (FEM), and the base instruction set located on the CPU PCA (modules 0-3). In other words, if the instruction set or the optional WCS, or FEM is enabled and then addressed, control store installed on the FAB assembly is disabled.

KIT CONTENTS

The HP 13304A Firmware Accessory Board Kit consists of the following:

<u>Description</u>	<u>HP Part No.</u>	<u>Quantity</u>
Screw, machine, panhead, no. 6-32, 1/4 in. (with external toothed lockwasher)	2360-0113	4
Jumper, plug	1258-0124	14
Firmware Accessory Board Assembly	5061-1339	1
Ribbon Cable Assembly	5061-1336	1
M/E/F-Series Firmware Installation and Reference Manual	12791-90001	1

MODULE NO.	ADDRESSES		JUMPER PREFIX				UPPER/LOWER 8K JUMPER
	DECIMAL	OCTAL	NOTE 1 9	10	11	12	NOTE 2 13
0	0-00255	00000-00377	0				
1	00256-00511	00400-00777	0	0	0	0	0
2	00512-00767	01000-01377	1				
3	00768-01023	01400-01777	1				
4	01024-01279	02000-02377	0				
5	01280-01535	02400-02777	0	1	0	0	0
6	01536-01761	03000-03377	1				
7	01762-02047	03400-03777	1				
8	02048-02303	04000-04377	0				
9	02304-02559	04400-04777	0	0	1	0	0
10	02560-02815	05000-05377	1				
11	02816-03071	05400-05777	1				
12	03072-03327	06000-06377	0				
13	03328-03583	06400-06777	0	1	1	0	0
14	03584-03849	07000-07377	1				
15	03850-04095	07400-07777	1				
16	04096-04351	10000-10377	0				
17	04352-04607	10400-10777	0	0	0	1	0
18	04608-04863	11000-11377	1				
19	04864-05119	11400-11777	1				
20	05120-05375	12000-12377	0				
21	05376-05631	12400-12777	0	1	0	1	0
22	05632-05887	13000-13377	1				
23	05888-06143	13400-13777	1				
24	06144-06399	14000-14377	0				
25	06400-06655	14400-14777	0	0	1	1	0
26	06656-06911	15000-15377	1				
27	06912-07167	15400-15777	1				
28	07168-07423	16000-16377	0				
29	07424-07679	16400-16777	0	1	1	1	0
30	07680-07935	17000-17377	1				
31	07936-08191	17400-17777	1				
32	08192-08447	20000-20377	0				
33	08448-08703	20400-20777	0	0	0	0	1
34	08704-08959	21000-21377	1				
35	08960-09215	21400-21777	1				
36	09216-09571	22000-22377	0				
37	09572-09727	22400-22777	0	1	0	0	1
38	09728-09983	23000-23377	1				
39	09984-10239	23400-23777	1				
40	10240-10495	24000-24377	0				
41	10496-10751	24400-24777	0	0	1	0	1
42	10752-10917	25000-25377	1				
43	10918-11263	25400-25777	1				
44	11264-11519	26000-26377	0				
45	11520-11775	26400-26777	0	1	1	0	1
46	11776-12031	27000-27377	1				
47	12032-12287	27400-27777	1				
48	12288-12543	30000-30377	0				
49	12544-12799	30400-30777	0	0	0	1	1
50	12800-13055	31000-31377	1				
51	13056-13311	31400-31777	1				
52	13312-13557	32000-32377	0				
53	13558-13823	32400-32777	0	1	0	1	1
54	13824-14079	33000-33377	1				
55	14080-14335	33400-33777	1				
56	14336-14591	34000-34377	0				
57	14592-14847	34400-34777	0	0	1	1	1
58	14848-15103	35000-35377	1				
59	15104-15359	35400-35777	1				
60	15360-15615	36000-36377	0				
61	15616-15871	36400-36777	0	1	1	1	1
62	15872-16127	37000-37377	1				
63	16128-16383	37400-37777	1				

1. Jumper 9 applies to block A only.
 2. Jumper 13 selects upper or lower 8K of control store.
 3. See figure 1-2 for jumper locations.

Figure 1-1. FAB Assembly Jumper Configurations

RECOMMENDED PROMs

One of the following recommended PROMs must be used to ensure reliable operation.

<u>4K PROMs</u>		<u>1K PROMs</u>	
HP Part No. 1816-1142		HP Part No. 1816-0782	
Signetics	N82S141F	Signetics	N82S129F
Harris	HMI-7641-5	Harris	HMI-7611-5
		Monolithic Memories	6301

1K ROM IC's in sockets A1 through A6. If part of the microprogram operates in the MSM (27400₈ to 27777₈), install the corresponding six 1K ROM IC's in sockets A7 through A12. (Refer to table 1-1 and figure 1-2.) Ensure that the IC's are oriented correctly as shown in figure 1-2 by matching pin 1 of each IC with the white dot of each IC socket.

- Determine the jumper requirements to match the module(s) selected. For modules 46 and 47, install jumpers 9A, 10A, 11A, 12A, and 13 as 1, 1, 1, 0, and 1, respectively. (See figure 1-1.)

1-3. INSTALLATION/REMOVAL

Figure 1-2 shows the locations of the addressable block jumpers and ROM IC sockets. The shaded areas show the location of each ROM IC socket. Jumpers are designated 9A through 12A, 10B through 12B, 10C through 12C, 10D through 12D, and 13. The numerical jumper notations represent the ROM address register bits 9 through 13. The alphabetical jumper notations represent the associated block of addressable control store. In other words, jumper notations A, B, C, and D correspond to blocks A, B, C, and D, respectively.

Table 1-1. ROM Locations for Block A

4-BIT SET	ROM PACKAGE LOCATION	
	LEAST SIGNIFICANT MODULE (LSM)	MOST SIGNIFICANT MODULE (MSM)
23-20 MSB	A6 (XU608)	A12 (XU808)
19-16	A5 (XU607)	A11 (XU807)
15-12	A4 (XU606)	A10 (XU806)
11-8	A3 (XU604)	A9 (XU804)
7-4	A2 (XU603)	A8 (XU803)
3-0 LSB	A1 (XU602)	A7 (XU802)

Notes:

- Locations A1-A6 are selected first (the lower 1/4K configuration).
- Locations A7-A12 are selected last (the upper 1/4K configuration).
- See figure 1-2 for ROM locations.

INSTALLATION PROCEDURE

CAUTION

ROM IC's may be permanently damaged if oriented incorrectly when installed and power is applied.

- Consult with the system programmer and determine the starting address and length of control store required for the microprogram.
- For block A configuration, use table 1-1 and figure 1-1 for ROM location and jumper configuration requirements, respectively. Use the following example as a guide:
 - Assuming the microprogram operates between 27000₈ and 27777₈, figure 1-1 shows that modules 46 and 47 are required.
 - Determine if the microprogram operates in the least significant module (LSM) or the most significant module (MSM). Module 46 is the LSM and module 47 is the MSM.
 - If part of the microprogram operates in the LSM (27000₈ to 27377₈) install the corresponding six

Table 1-2. ROM Locations for Blocks B, C, and D

8-BIT SET	ROM PACKAGE LOCATION	
	LEAST SIGNIFICANT MODULE PAIR (LSMP)	MOST SIGNIFICANT MODULE PAIR (MSMP)
23-16 MSB	B3 (XU404) C3 (XU204) D3 (XU104)	B6 (XU409) C6 (XU209) D6 (XU109)
15-8	B2 (XU402) C2 (XU202) D2 (XU102)	B5 (XU408) C5 (XU208) D5 (XU108)
7-0 LSB	B1 (XU401) C1 (XU201) D1 (XU101)	B4 (XU406) C4 (XU206) D4 (XU106)

Notes:

- Locations suffixed 1, 2, and 3 are selected first (the lower 1/2K configuration).
- Locations suffixed 4, 5, and 6 are selected last (the upper 1/2K configuration).
- See figure 1-2 for ROM locations.

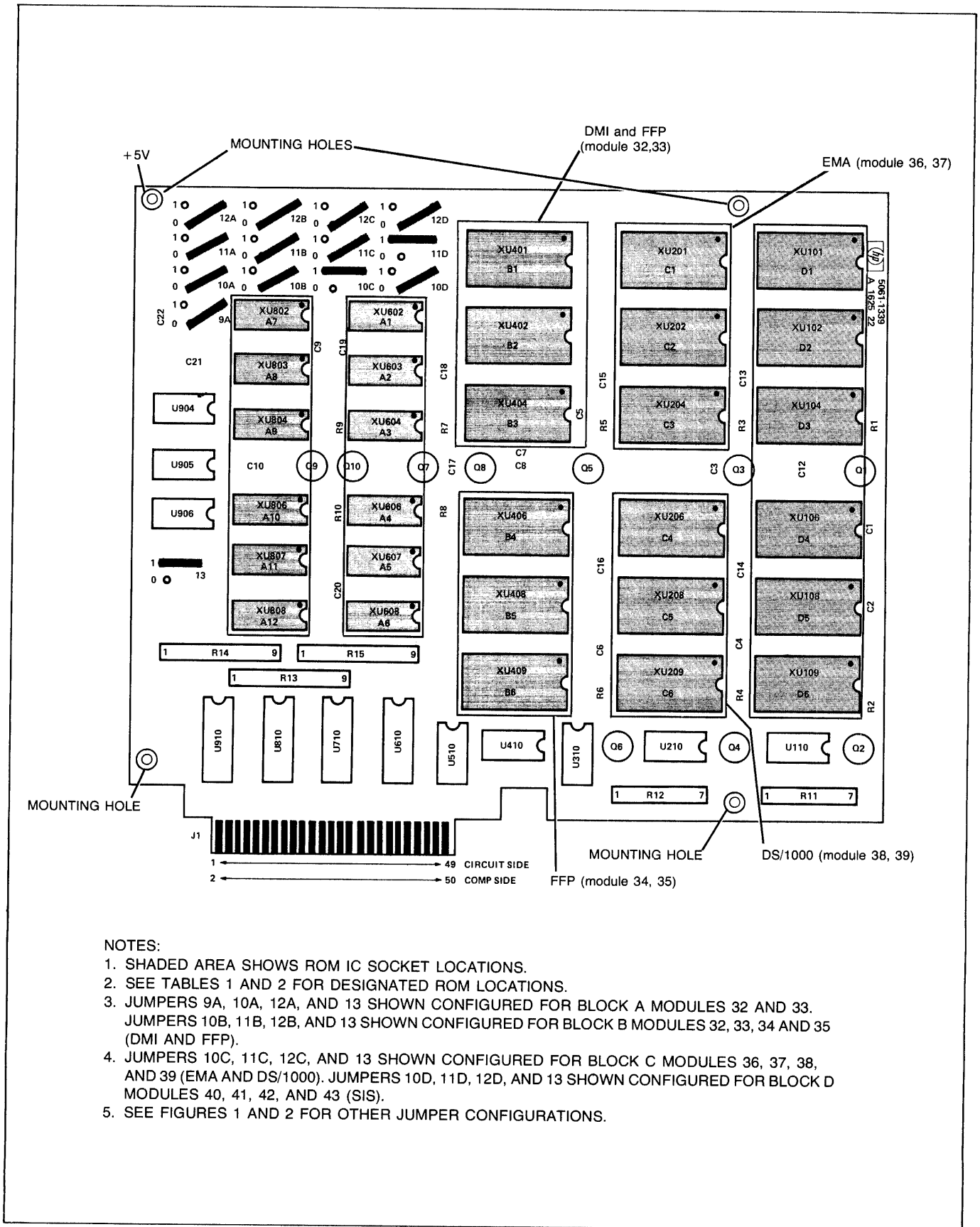

NOTES:

1. SHADED AREA SHOWS ROM IC SOCKET LOCATIONS.
2. SEE TABLES 1 AND 2 FOR DESIGNATED ROM LOCATIONS.
3. JUMPERS 9A, 10A, 12A, AND 13 SHOWN CONFIGURED FOR BLOCK A MODULES 32 AND 33. JUMPERS 10B, 11B, 12B, AND 13 SHOWN CONFIGURED FOR BLOCK B MODULES 32, 33, 34 AND 35 (DMI AND FFP).
4. JUMPERS 10C, 11C, 12C, AND 13 SHOWN CONFIGURED FOR BLOCK C MODULES 36, 37, 38, AND 39 (EMA AND DS/1000). JUMPERS 10D, 11D, 12D, AND 13 SHOWN CONFIGURED FOR BLOCK D MODULES 40, 41, 42, AND 43 (SIS).
5. SEE FIGURES 1 AND 2 FOR OTHER JUMPER CONFIGURATIONS.

Figure 1-2. Firmware Accessory Board

- c. For block B, C, or D configuration, use table 1-2 and figure 1-1 for ROM location and jumper configuration requirements, respectively. Use the following example as a guide:
1. Assuming the microprogram operates between 34000₈ and 35777₈, figure 1 shows that modules 56, 57, 58, and 59 are required.
 2. Determine if the microprogram operates in the least significant module pair (LSMP) or the most significant module pair (MSMP). Modules 56 and 57 are the LSMP and modules 58 and 59 are the MSMP.
 3. If part of the microprogram operates in the LSMP (34000₈ to 34777₈), install the corresponding three 4K ROM IC's in sockets B1 through B3. (Refer to table 1-2 and figure 1-2.) If part of the microprogram operates in the MSMP (35000₈ to 35777₈), install the corresponding three 4K ROM IC's in sockets B4 through B6. Although blocks B, C, or D may be used, it is recommended that block B be used first, block C second, and block D last. Ensure that the IC's are oriented correctly as shown in figure 1-2 by matching pin 1 of each IC with the white dot of each IC socket.
 4. Determine the jumper requirements to match the modules selected. For modules 56 through 59, install jumpers 10B, 11B, 12B, and 13 as 0, 1, 1, and 1, respectively. (See figures 1-1 and 1-2.)

WARNING

Hazardous voltages are present inside the computer mainframe! Before installing the FAB, set the ~LINE and BATTERY switches to OFF and DISCONNECT THE POWER CORD!

- d. Set ~LINE and BATTERY switches to OFF and disconnect the power cord.
- e. Disconnect I/O extender cable assembly (if present) from CPU PCA edge connector.
- f. Loosen screw located in rear fold of bottom cover; slide cover toward rear and remove.
- g. Position FAB assembly over the CPU PCA standoffs and fasten it securely with the four screws and lockwashers. (See figure 1-3.) Note that the FAB assembly obtains its dc power from the CPU PCA standoffs.
- h. Connect FAB connector assembly between FAB assembly connector J1 and CPU PCA connector J2.

- i. Replace bottom cover.
- j. Connect I/O extender cable assembly (if present) to CPU PCA connector J3.
- k. Connect power cord to the computer and set ~LINE and BATTERY switches to ON.
1. Check that the +5V CPU voltage, when measured at the crossover board test point is 5.15 Volts. Adjust if necessary. The adjustment procedure is located in the appropriate Installation and Service Manual.

Installation is now complete and ready for the user's control store microprogramming application.

REMOVAL PROCEDURE

- a. Set ~LINE and BATTERY switches to OFF and disconnect the power cord.
- b. Disconnect I/O extender cable assembly (if present) from CPU PCA edge connector.
- c. Loosen screw located in rear fold of bottom cover; slide cover toward rear and remove.
- d. Remove FAB ribbon connector assembly between FAB assembly connector J1 and CPU PCA connector J2.
- e. Remove the four screws and lockwashers (see figure 1-3) which fasten the FAB to the CPU standoffs.

Removal is now complete, refer to the previous section for configuration and installation procedures.

1-4. SERVICE INFORMATION

Because of its design, the FAB assembly is field replaceable as an assembly. However, a system failure can be isolated to the FAB-ROM combination by running the appropriate self test and/or diagnostic corresponding to the firmware that is installed on the FAB.

- a. If Scientific Instruction Set (SIS), Extended Memory Area (EMA), Dynamic Mapping Instructions (DMS), Fast Fortran Processor (FFP), or Distributed System Firmware (DS/1000) is installed on the FAB, run the associated selftest and/or diagnostic. Self tests are described in the appropriate section of this manual. For diagnostic operation, the appropriate diagnostic manual must be consulted.
- b. If a particular test fails, verify that the address jumpers on the FAB are configured correctly. Ensure that the ribbon cable is correctly seated.

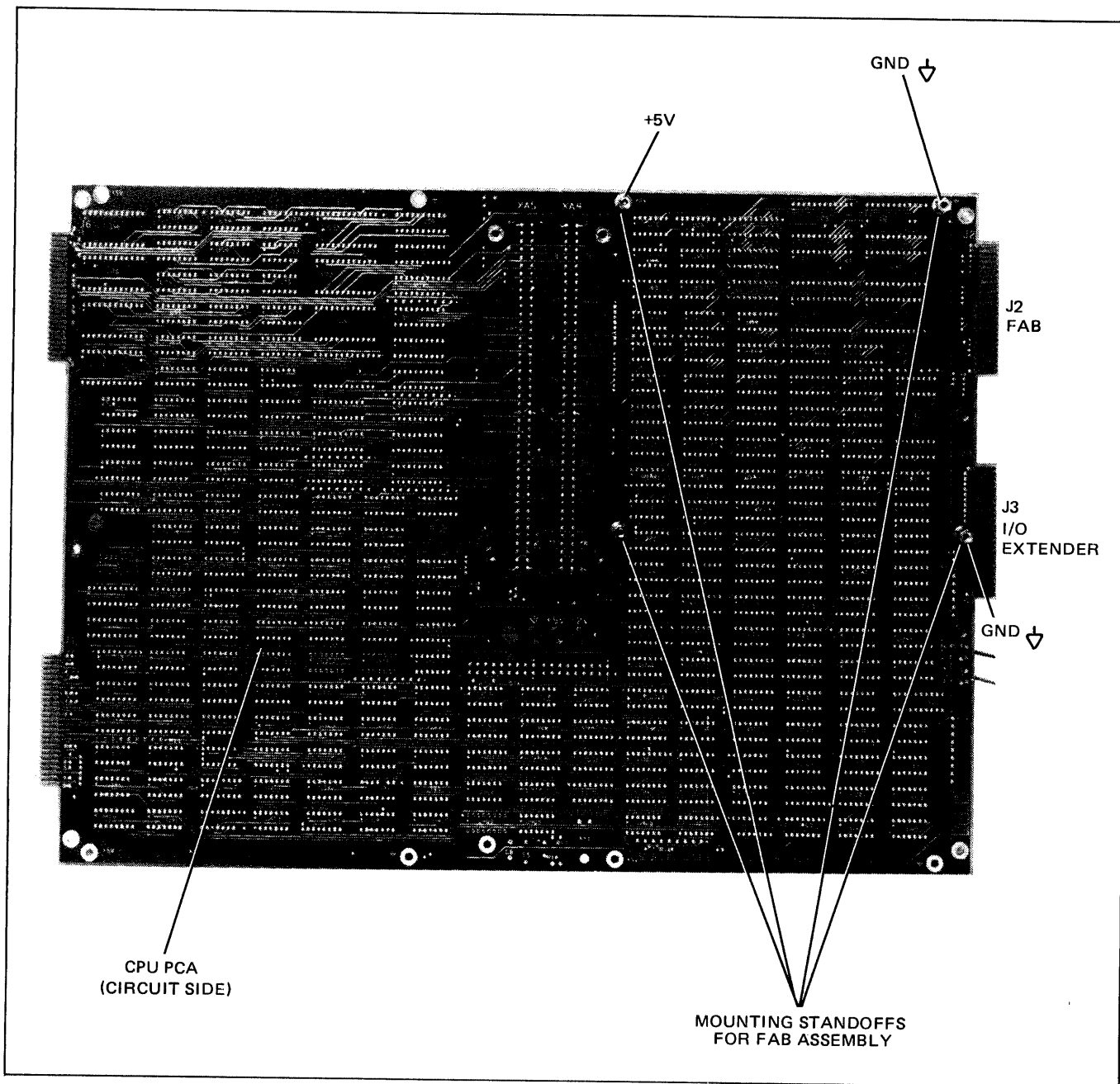

Figure 1-3. Firmware Accessory Board Mounting Details

- c. Verify that the +5V CPU voltage is set at the recommended setting of 5.15 volts when measured at the crossover PCA test point. Refer to the appropriate installation and service manual for the power supply voltage adjustment.
- d. If the test still fails, insert a known good set of ROMs in the failing locations and re-run the diagnostic and/or self test.
- e. If the test now passes, defective ROMs are indicated. Change one ROM at a time to isolate the defective ROM(s).

If after installing a new FAB, the test still fails, install a new ribbon cable assembly and run the tests again.

If the test still fails, a defective FAB or ribbon cable assembly is indicated. Install a new FAB and run the tests.

- f. If a failure still exists, contact your nearest Hewlett-Packard Sales and Service Office. A list of HP Sales and Service Offices is provided in the appropriate HP 1000 Series Computer Installation and Service Manual.

HP 12791A FIRMWARE EXPANSION MODULE

SECTION

II

2-1. INTRODUCTION

This section provides installation and service information for the HP 12791A Firmware Expansion Module (FEM) which is standard on the HP 1000 E/F-Series Computers and is an accessory for the HP 1000 M-Series Computer. Installation and reference information for the various HP firmware options which can be installed on the FEM can be found in the appropriate section of this manual. Additional information is provided in this manual listed in the preface.

NOTE

Terminology may differ somewhat between the M-Series and E/F-Series computers. The E/F-Series terminology will be used, but the M-Series user should note that the following are synonymous.

<u>E/F-Series</u>	<u>M-Series</u>
Control Memory	Control Store
Control Memory Address Register (CMAR)	ROM Address Register (RAR)
Microinstruction Register (MIR)	ROM Instruction Register (RIR)

2-2. DESCRIPTION

The 16,384 words of addressable Control Memory in the HP 1000 E/F-Series computers are divided into sixty-four 256 word modules (0 through 63). The 4,196 words of addressable Control Memory in the HP 1000 M-Series computer are divided into sixteen 256 word modules (0 through 15). See the appropriate figure, 11-1, 11-2, or 11-3 in section XI for the allocation of Control Memory. The modules which hold the computer base instruction set are not available to the user microprogrammer (modules 0,1,14,15 in M-Series and modules 0,1,2,3 in E/F-Series computers). Any other Control Memory modules not filled by microprogrammed Hewlett-Packard options are available to the user microprogrammer. It is recommended that the user microprogrammer only use modules which are not HP reserved, or specified for HP microprogrammed options. If the user microprogrammer uses modules which are specified for HP firmware options or HP reserved, he will not be able to use present or future HP microprogrammed options which reside in those Control Memory modules.

The HP 12791A Firmware Expansion Module (FEM) contains 24 integrated-circuit (IC) sockets which are divided into eight sets of three sockets each (see figure 2-1). Each

set of three 24 pin sockets can accommodate 4k (512 × 8) or 8k (1024 × 8) read-only-memory (ROM) ICs. Since each set is individually addressable, up to eight discrete sections (or blocks) of Control Memory can be installed on the FEM. Each set of sockets has a corresponding 10 rocker switch DIP pack which is configured to enable or disable the set, specify the size of ROMs used, and specify the Control Memory modules which will be addressed by these sockets (see table 2-1 for switch configuration settings).

BLOCK ADDRESSING

The eight sets of three 24-pin sockets are identified as SETA, SETB, SETC, SETD, SETE, SETF, SETG, and SETH. Within each set, the sockets are designated as sockets 1, 2, or 3 (e.g. A1, A2, and A3). Socket A1 contains the least significant bits (bits 0-7) of the microinstruction, socket A2 contains bits 8-15, and socket A3 contains the most significant bits (bits 16-23). The corresponding 10 rocker switch DIP packs are identified as SWA, SWB, SWC, SWD, SWE, SWF, SWG, and SWH.

If 4k ROMs (512 word by 8 bit) are used in a set, the set contains 512 words (two contiguous modules) of Control Memory. The two contiguous modules begin on an even module number (e.g., 36 and 37, or 52 and 53). If 8k ROMs (1024 word by 8 bit) are used in a set, the set contains 1024 words (four contiguous modules) of Control Memory. The four contiguous modules begin on a module number which is an even multiple of 4 (e.g., 24 through 27, or 48 through 51). Both 4k and 8k ROMs can be used on the FEM at the same time, since each set of 3 sockets can be individually configured for ROM size. Switch settings and part locations are shown in table 2-1 and figure 2-1 respectively.

PRIORITY

Control Memory modules installed on the FEM assembly have lower priority than the 13197A Writable Control Store (WCS) but higher priority than the base instruction set located on the CPU PCA or the FAB board.

In an E/F-Series Computer the priority is as follows:

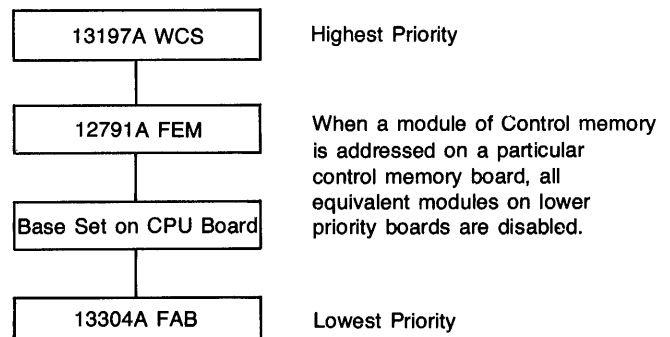

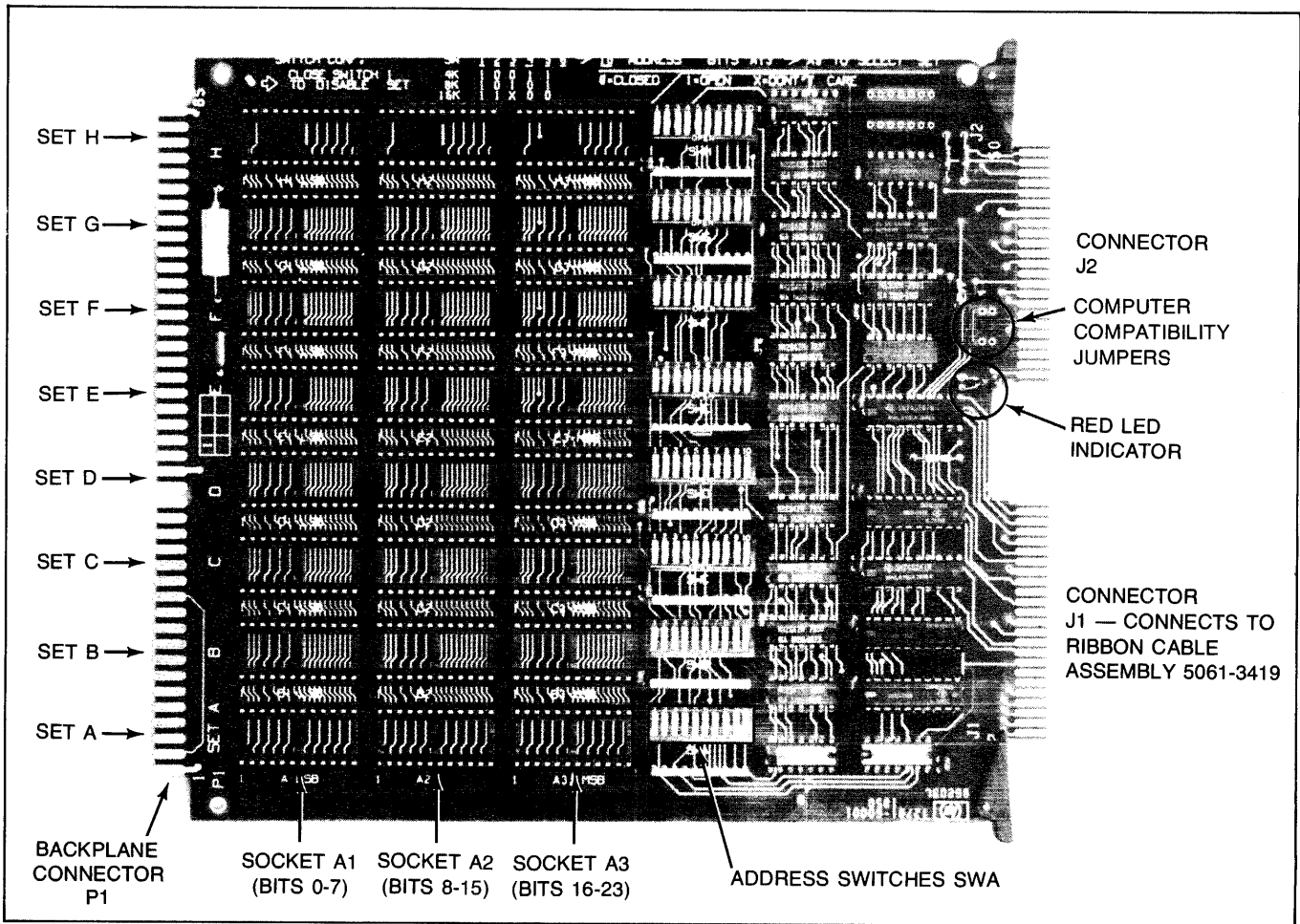
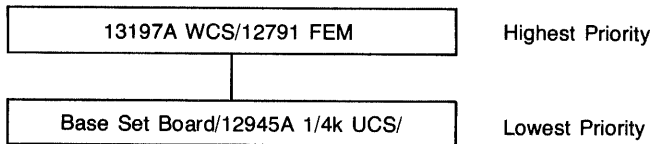

Figure 2-1. Firmware Expansion Module

In a M-Series Computer the priority is as follows:



RECOMMENDED PROMs

The following are the recommended PROMs for use with the FEM.

<u>4k PROMs</u>		<u>8k PROMs</u>	
HP Part No.	1816-1163	HP Part No.	1816-1160
Signetics	N82S141F	Signetics	N82S181F
Harris	7641	Harris	7681
Monolithic Memories	6341	Monolithic Memories	6381

PRODUCT CONTENTS

The HP 12791A Firmware Expansion Module Product consists of the following:

<u>Description</u>	<u>HP Part No.</u>	<u>Quantity</u>
Firmware Expansion Module Assembly	12791-60001	1
Ribbon Cable Assembly	5061-3419	1
HP 1000 M/E/F-Series Firmware Installation and Reference Manual	12791-90001	1

2-3. INSTALLATION/REMOVAL

POWER REQUIREMENTS

The +5V power required by the Firmware Expansion Module is obtained from the processor I/O backplane. An unloaded FEM (no ROMs installed) sinks 1.20 amperes of +5V I/O current. Each set of three ROMs installed on the

FEM sinks an additional .525 amperes of current, regardless if the ROMs are 4k or 8k ROMs. Therefore, a fully loaded FEM will sink 5.4 amperes. Calculate the total current required by the FEM and all other printed-circuit assemblies (PCA's) resident in the processor I/O cage. If the total current requirement is greater than the +5V I/O supply capability, then one or more interface PCA's must be removed and installed in a HP 12979A/B I/O Extender.

NOTE

The processor I/O current availability is given in the appropriate HP 1000 Operating and Reference Manual.

INSTALLATION PROCEDURE

Figure 2-1 identifies each set of sockets and the associated address switches. Control Memory allocation is contained in tables 11-1, 11-2, and 11-3 in section XI. Refer to the appropriate table to determine the starting address of the Control Memory modules which are to be installed on the FEM. Table 2-1 contains the switch settings which determine the Control Memory modules that will be addressed by the set of sockets.

To install the FEM, proceed as follows:

CAUTION

ROM IC's may be permanently damaged if oriented incorrectly when installed and power is applied.

- If the firmware is HP supplied optional firmware, see the appropriate table in section XI to determine the module number and starting address of the firmware. If user written firmware is to be installed, the microcode should occupy Control Memory modules which are specified for user microprogramming.
- On the FEM, load the three ROM IC's corresponding to the Control Memory modules to be installed into one of the eight sets of sockets. Ensure that the ROM IC's are oriented with the notched ends facing the same direction as the other IC's on the board (towards backplane connector P1). The ROM containing the least significant bits (bits 0-7) of the microinstruction is to be installed in socket 1, the ROM containing bits 8-15 is to be installed in socket 2, and the ROM containing the most significant bits (bits 16-23) is to be installed in socket 3.
- Set the associated address switches for the appropriate modules of Control Memory as specified in table 2-1.
- Repeat steps a, b, and c for each section of Control Memory which is to be installed.
- All unused socket sets must be disabled by setting switch S1 of the unused sets to the closed position.

WARNING

Hazardous voltages are present inside the processor mainframe! Before installing the FEM, set the AC LINE AND BATTERY switches to OFF and DISCONNECT THE POWER CORD!

- Set the computer compatibility jumpers on the FEM as shown below. The jumpers should be in the appropriate sockets to correspond to the type of computer with which the FEM is to be used.

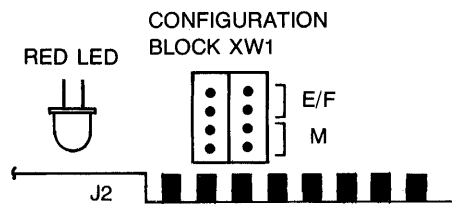

- Set the AC LINE and BATTERY switches to OFF and disconnect the power cord.
- Disconnect battery cable (if present) from BAT. INPUT connector and remove I/O PCA cage cover.
- Disconnect I/O extender cable assembly (if present) from the CPU PCA edge connector J3.
- Loosen screw located in rear fold of bottom cover; slide cover toward rear and remove.
- Remove existing connector assembly from CPU PCA and FAB (E/F-Series), or CPU PCA and ROM PCA (M-Series), if installed. See figure 2-2.
- Pass the ribbon cable assembly (part no. 5061-3419) through the opening in chassis below I/O PCA cage cover.

NOTE

The ribbon cable assembly (part no. 5061-3419) supplied with the FEM must be used for reliable operation. Use of any other ribbon cable assembly may result in intermittent or unpredictable errors.

- Connect the ribbon cable assembly (part no. 5061-3419) to FAB and CPU PCA in a E/F-Series computer, (ROM PCA and CPU PCA in a M-Series computer).
- Replace bottom cover. Reconnect I/O extender cable assembly (if present) to CPU edge connector J3.
- Install the FEM in I/O PCA cage slot 10 or 11 depending on whether or not a 13197A Writable Control Store Board (WCS) is present. If no WCS is present, install the FEM in slot 10. If one WCS is present install the FEM in slot 11.

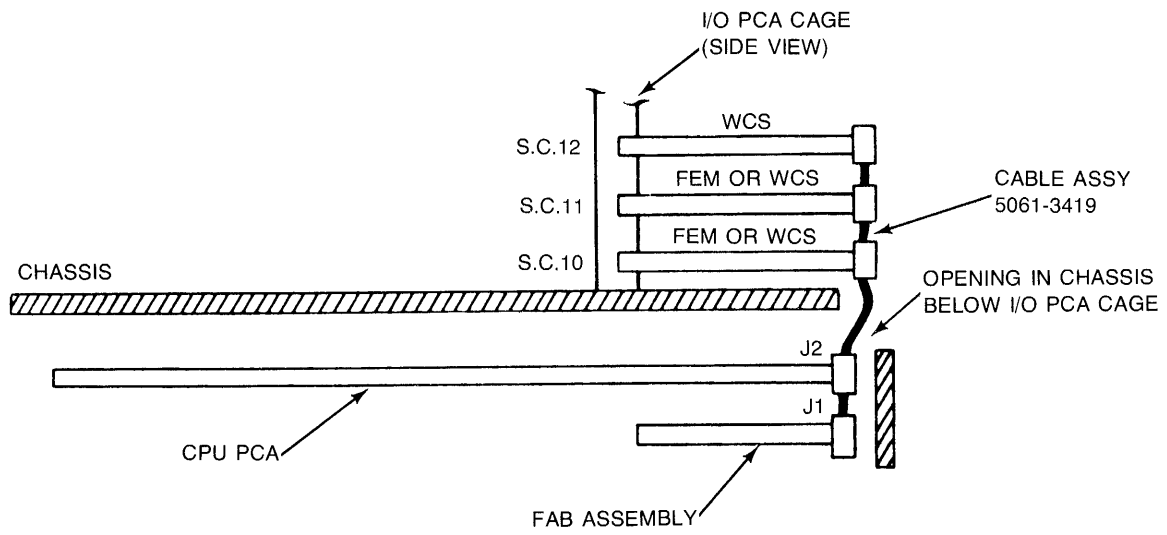

a. Installation Details (HP 1000 E/F-Series Computer)

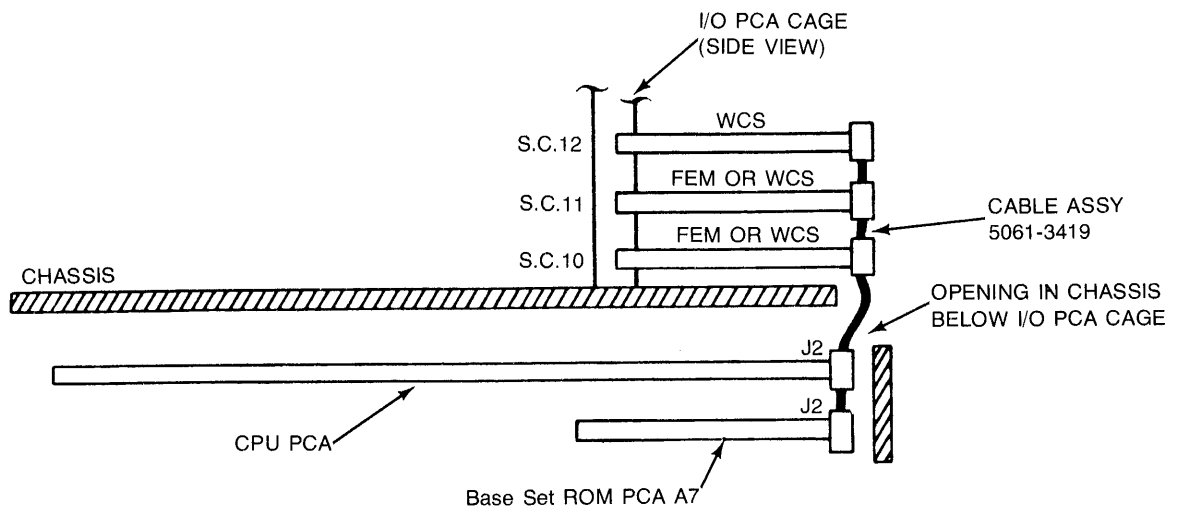

NOTES:

- FEM → 12791A FIRMWARE EXPANSION MODULE
- FAB → 13304A FIRMWARE ACCESSORY BOARD
- WCS → 13197A WRITABLE CONTROL STORE

b. Installation Details (HP 1000 M-Series Computer)

Figure 2-2. Installation Details

- p. Connect the cable assembly to FEM board connector J1 and to WCS PCA(s) if present. Any unused connectors should be left on if they do not interfere with the I/O PCA cage cover or I/O cable hoods directly above the FEM. If it is necessary, unused connectors can be carefully removed with a sharp knife or scissors. After removal, inspect the ribbon cable to verify that there are no shorts between any ribbon cable conductors.
- q. Replace I/O PCA cage cover and reconnect battery cable (if present) to BAT. INPUT connector.
- r. Plug processor power cord into power mains receptacle and set AC LINE to ON, and BATTERY switch to INT., if the power fail option is installed. If the battery is discharged upon turning on the AC LINE, it will take a few minutes for the battery to charge up to a minimum level before the processor will begin operation.

The installation is now complete and ready for use of HP optional firmware, or the user's own microprogramming application.

REMOVAL PROCEDURE

- a. Set AC LINE and BATTERY switches to OFF and disconnect the power cord.
- b. Disconnect battery cable (if present) from BAT. INPUT connector and remove I/O PCA cage cover.
- c. Remove ribbon cable connector from FEM board connector J1, and remove FEM from I/O slot.

The removal is now complete, and additional HP optional or user written firmware can be installed as described in the installation procedure.

VERIFICATION

If HP supplied optional firmware is installed of the FEM, correct operation can be verified by running the appropriate self test and/or diagnostic on the installed firmware.

2-4. SERVICE INFORMATION

A system failure can be isolated to the FEM-ROM combination by running the appropriate self test and/or diagnostic corresponding to the firmware that is installed on the FEM.

The red LED indicator on the FEM is lit whenever a set of ROMs on the board is being addressed (i.e. the address sent to the board corresponds to the switch settings on one of the enabled sets).

If the base set is installed on the FEM, the LED will appear to be continuously lit when the computer is in the halt mode.

- a. If Scientific Instruction Set (SIS), Extended Memory Area (EMA), Vector Instruction Set (VIS), or Distributed System Firmware (DS/1000) is installed on the FEM, run the associated self test and/or diagnostic. Self tests are described in the appropriate section of this manual. For diagnostic operation, the appropriate diagnostic manual must be consulted.
- b. If a particular test fails, verify that the address switches on the FEM are configured correctly. All unused sets of sockets must be disabled by setting switch 1 to the closed position. Ensure that the ribbon cable and FEM are correctly seated.
- c. Verify that the +5V CPU voltage is set at the recommended setting of 5.15 volts when measured at the crossover PCA test point. Refer to the appropriate installation and service manual for the power supply voltage adjustment.
- d. If the test still fails, insert a known good set of ROMs in the failing locations and re-run the diagnostic and/or self test.
- e. If the test now passes, defective ROMs are indicated. Change one ROM at a time to isolate the defective ROM(s).

If the test still fails, defective FEM or ribbon cable assembly is indicated. Install a new FEM and run the tests.

If after installing a new FEM, the test still fails, install a new ribbon cable assembly and run the tests again.

- f. If a failure still exists, contact your nearest Hewlett-Packard Sales and Service Office. A list of HP Sales and Service Offices is provided in the appropriate HP 1000 Series Computer Installation and Service Manual.

HP 13197A WRITABLE CONTROL STORE

SECTION

III

3-1. INTRODUCTION

This section describes the HP 13197A Writable Control Store (WCS) Kit used with the HP 1000 M-Series (2105/2108/2112), E-Series (2109/2113), and F-Series (2111/2117) computers. This section covers general information, installation, programming, and general theory of operation. It is written for the individual who already has experience as an Assembly language programmer. Additional information is provided in the following manuals.

- a. Manuals listed in the Preface of this manual.
- b. *RTE Driver DVR36 for HP 12978/13197A Writable Control Store Board Programming and Reference Manual*, part no. 13197-90001.

The HP 13197A Writable Control Store Kit is fully compatible with the HP 1000 M/E/F-Series computers. The Writable Control Store (WCS) holds 1024 words (four control memory modules) and is commonly called a 1K WCS. Computer commands specify which four control memory modules are contained on each HP 13197A WCS printed circuit assembly (PCA).

NOTE

Where installation or operational data for the kit is affected by differences in the HP 1000 M-Series and E/F-Series computers, these differences are noted in text. Also, terminology may differ somewhat between the M-Series and E/F-Series computers. The E/F-Series terminology will be used, but the M-Series user should note the following:

<u>E/F-Series</u>	<u>M-Series</u>
Control Memory	Control Store
Control Memory Address Register (CMAR)	ROM Address Register (RAR)
Microinstruction Register (MIR)	ROM Instruction Register (RIR)

KIT CONTENTS

The HP 13197A WCS Kit consists of the following:

- a. Writable Control Store PCA, part no. 13197-60001.
 - b. Ribbon Cable Assembly, part no. 5061-3419.
 - c. *HP 1000 M/E/F-Series Firmware Installation and Reference Manual*, part no. 12791-90001.
- The printed circuit assembly and ribbon cable assembly contained in the kit are shown in figure 3-1.

SPECIFICATIONS

Table 3-1 lists the characteristics and specifications of the HP 13197A Writable Control Store PCA.

3-2. INSTALLATION/REMOVAL

POWER CONSIDERATIONS

The +5V power required by the WCS is obtained from the computer I/O backplane. Each WCS PCA installed requires 2.2 amperes of current. Calculate the total current required by the WCS PCA and all other printed-circuit assemblies resident in the I/O PCA cage. If the total current requirement is greater than the +5V supply capability, then one or more interface PCA's must be removed and installed in a compatible I/O extender.

NOTE

The I/O current availability is given in the appropriate *HP 1000 Series Computer Operating and Reference Manual*.

INSTALLATION PROCEDURE

The Base Set ROM PCA occupies position A7 in the HP 1000 M-Series computer as standard equipment. In the HP 1000 E/F-Series computer, position A7 is occupied by the Firmware Accessory Board (FAB). For installation of WCS in the E/F-Series, see figure 2-2a. For installation in the M-Series, see figure 2-2b.

Install the Writable Control Store kit as follows:

- a. Ensure that the computer operates properly prior to installing the writable control store kit.
- b. If WCS is to be installed in an M-Series computer, remove computer compatibility jumper W1 (see figure 3-2). If WCS is to be installed in an E/F-Series computer, jumper W1 remains installed.

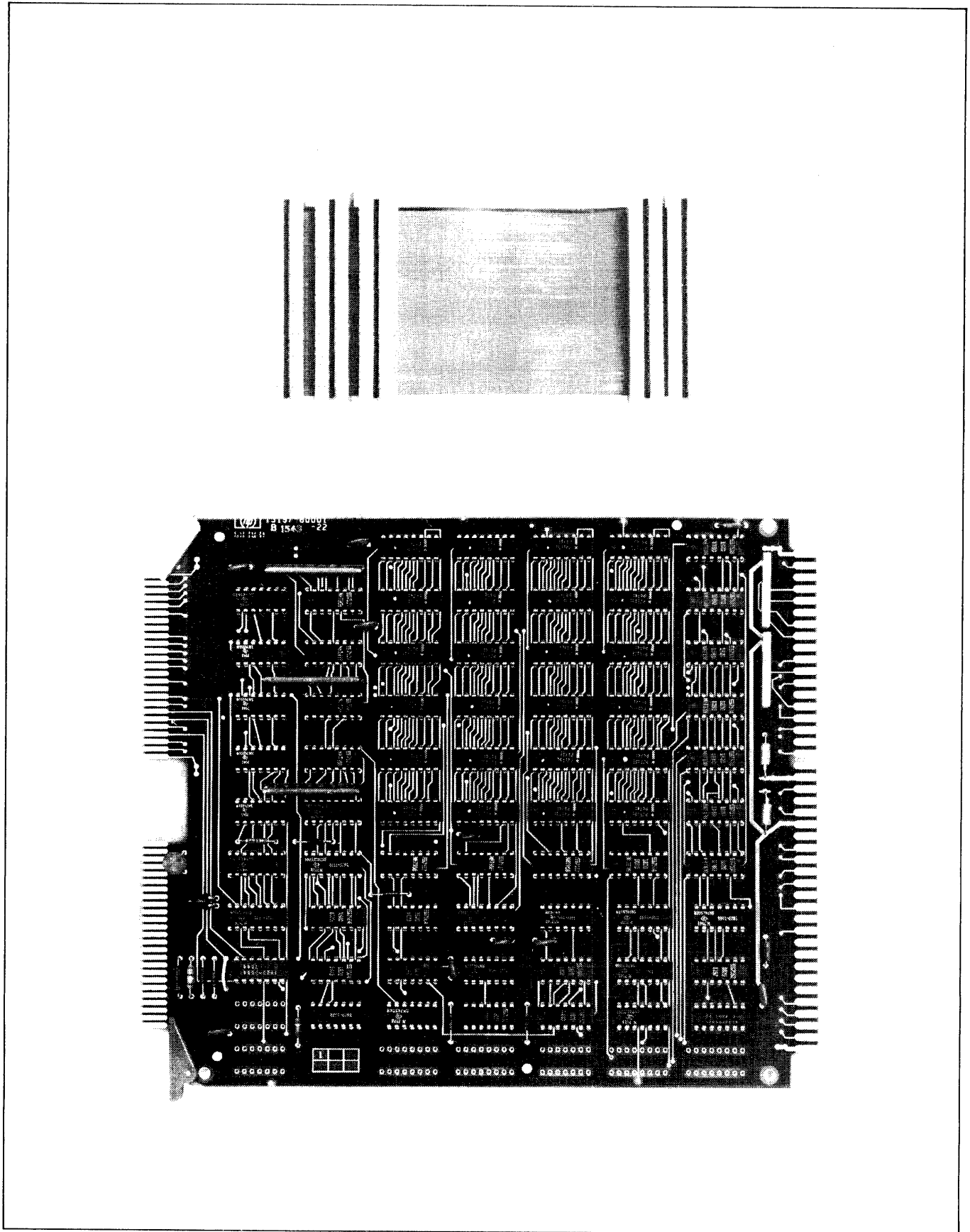

Figure 3-1. HP 13197A Writable Control Store Kit

WARNING

Hazardous voltages are present inside the processor mainframe! Before installing the writable control store board, set the ~LINE and BATTERY switches to off and DISCONNECT THE POWER CORD!!

- c. Set ~LINE and BATTERY switches to OFF and disconnect the power cord.
- d. Disconnect I/O extender cable assembly (if present) from CPU PCA edge connector J3.
- e. Loosen screw located in rear fold of bottom cover; slide cover toward rear and remove.
- f. Remove existing connector assembly from CPU PCA and FAB in an E/F-Series, (CPU PCA and ROM PCA in a M-Series Computer), if installed (See figure 2-2).
- g. Disconnect battery cable (if present) from BAT.INPUT connector and remove I/O PCA cage cover.
- h. Pass the flat cable assembly (part no. 5061-3419) through opening in chassis below I/O PCA cage.
- i. Connect cable assembly to FAB and CPU PCA in a E/F-Series computer, (ROM PCA and CPU PCA in a M-Series Computer).
- j. Replace processor bottom cover. Reconnect I/O extender cable assembly (if present) to CPU PCA edge connector J3.

- k. Place the first writable control store PCA in slot number 10 (select code 10) of the I/O section of the computer. Any additional writable control store PCA's should be placed first in slot 11 then in slot 12.
- l. Install the connectors of the flat cable assembly to WCS board connector J1 as shown in figure 2-2.

NOTE

If an I/O PCA that requires a cable (hood) connector on the back is installed immediately above the WCS, double the flat cable assembly back or cut it to make room for the I/O cable connector. The cable may be carefully cut with scissors or a sharp knife. If cut, inspect the cable conductors for possible shorts.

- m. Replace I/O PCA cage cover and reconnect battery cable (if present) to BAT.INPUT connector.
- n. Plug processor power cord into power mains receptacle and set ~LINE to ON, and BATTERY switch in INT. if the power fail option is installed.

REMOVAL PROCEDURE

- a. Set ~LINE and BATTERY switches to OFF and disconnect the power cord.
- b. Remove the connectors of the flat cable assembly from WCS board edge connector J1 and any other Control Memory boards installed in the I/O card cage.

Table 3-1. HP 13197A Writable Control Store PCA Specifications

<p>CAPACITY</p> <p>Words Available: 1024 per WCS PCA Maximum WCS PCS's: two per HP 2105; three per 2108/ 2109/2111/2112/2113/2117 Word Size: 24 bits</p> <p>MEMORY SPEED</p> <p>Access: 132 nsec maximum Full Microinstruction Cycle: M-Series: 325 nsec. E/F-Series: 175 or 280 nsec.</p> <p>INSTALLATION</p> <p>Each WCS PCA requires the use of one Input/Output slot (slot 10, 11, or 12).</p> <p>DATA STORAGE OR READBACK</p> <p>Input/Output Group instructions or a Dual Channel Port Controller are used to load into or read from the WCS.</p>	<p>WCS CURRENT REQUIREMENTS</p> <p>+5 volt supply: 2.2A rms -2 volt supply: 7 mA rms</p> <p>DIMENSIONS</p> <p>Width: 7-3/4 inches (196.8 mm) Height: 8-11/16 inches (220.7 mm)</p> <p>WEIGHT</p> <p>Net Weight: 18 oz (511.2 gm) (card and cable only) Shipping Weight: 4 lb (2.27 kg)</p> <p>INPUT LEVELS</p> <p>"1" state: 1.9 volts minimum "0" state: 1.1 volts maximum</p> <p>OUTPUT LEVELS</p> <p>"1" state: 2.4 volts minimum "0" state: 0.8 volt maximum</p>
---	--

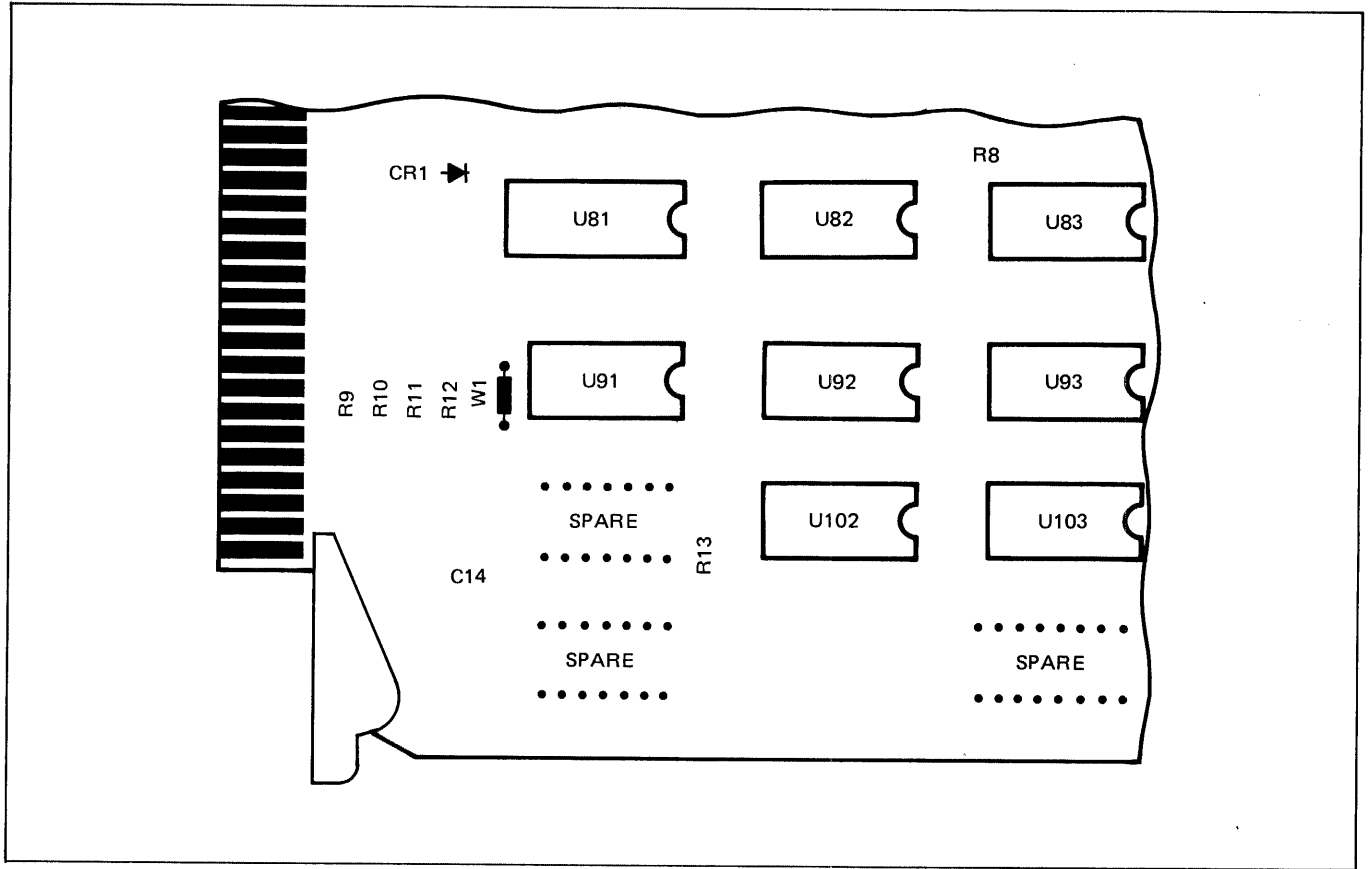

Figure 3-2. Computer Compatibility Jumper W1 Location

- c. Remove the WCS board from the I/O card cage.

VERIFICATION. Perform the diagnostic test as outlined in the *WCS Diagnostic Reference Manual*, part no. 13197-90002. If the diagnostic program is completed without error, the PCA is installed and operating properly. If the diagnostic program indicates errors, halt the computer, turn off power, and recheck all of the above installation procedures. Correct where necessary, then recheck and repeat the diagnostic test.

3-3. PROGRAMMING

Standard I/O instructions control the HP 13197A WCS operation. The WCS operates in the following states:

1. Control memory operation enabled.
2. Control memory operation disabled.
3. WCS commands accepted (command state).
4. WCS data (i.e., microinstructions) can be read or written (data state).

The first two states (1 and 2) are called minor states. The second two states (3 and 4) are called major states. One

minor state and one major state operate concurrently whenever power is applied to the WCS. Upon initial application of power, control memory operation is disabled (state 2), and WCS commands are accepted (state 3).

Data can be transferred via the Dual Channel Port Controller (DCPC) while in the data state.

ENABLING CONTROL MEMORY OPERATION

To allow microinstructions stored in the WCS to execute, control memory operation must be enabled. Control memory operation is enabled by the execution of a Set Flag instruction to the WCS select code (SC):

STF SC

When this instruction is executed, the WCS is enabled sometime during T5 of the I/O cycle.

DISABLING CONTROL MEMORY OPERATION

To prevent microinstructions stored in the WCS from executing, control memory operation must be disabled.

This is accomplished by execution of a Clear Flag instruction to the WCS select code (SC):

CLF SC

WCS does not become disabled until sometime during T5 of the I/O cycle.

The operation of the WCS is temporarily disabled when any I/O instruction is executed in the WCS select code. Thus, if the microprocessor is executing microcode contained in the WCS, no I/O instructions (except CLF, as above) may be executed to or from the WCS. This means that no microinstructions stored in a WCS can execute I/O instructions to itself.

NOTE

Since WCS does not return the FLG signal to the I/O backplane, the enable/disable status of the board cannot be determined by executing an SFS instruction.

SENDING COMMANDS

When the WCS is in the command state, two commands are accepted, each of which is in the form of a 16-bit word. The first word is interpreted as a WCS address specification. The second word is interpreted as a specification for the four control memory module numbers. WCS interprets words received in the command state as alternately address or module numbers until the data state is initiated. Thus, the third word is interpreted as a WCS address, the fourth as module numbers, etc.

The command state is initiated by execution of a Clear Control Instruction to the WCS select code (SC):

CLC SC

The WCS address word commands the WCS to set the WCS Address Register to the specified address. The WCS Address Register value determines which WCS location is read from or written into when the WCS is in the data state. The format of the WCS address word is the following:

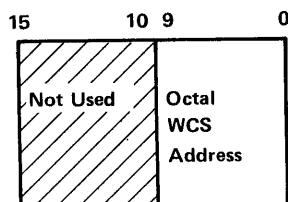

This address is octal and is relative to the first location in the WCS. The first location is at address 0 (zero). The last location is at address 1777.

The four control memory module numbers are assigned by blocks. The 1024 words contained in the WCS are divided into two blocks of 512 words each. Each block is in turn divided into two 256-word modules. WCS addresses 0-511 (0-777 octal) are contained in the first block; addresses 512-1023 (1000-1777 octal) are contained in the second block. The modules assignment word specifies which two control memory modules are stored in each block. The module assignment word has the following format:

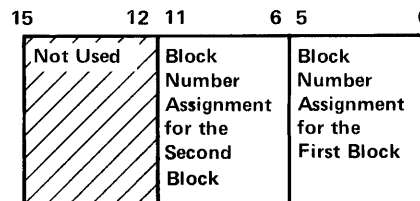

Bits 5-0 determine the control memory module numbers assigned to the two modules in the first block. Bits 11-6 determine the module numbers assigned to the two modules in the second block. The number of the first module is given by multiplying the block number by 2. Thus, the module number of a block is always even. For example, if bits 5-0 specify 5 for the block number assignment, the first block serves as control memory for modules 10 and 11.

The two blocks may be assigned block numbers that are not adjoining. For example, the first block can be assigned as block 5 (control memory modules 10 and 11) and the second block can be assigned as block 2 (control memory modules 4 and 5).

Control memory modules available to the user for HP 1000 M/E/F-Series computers are shown in tables 11-1, 11-2 and 11-3, respectively.

READING AND WRITING WCS DATA

When the WCS is in the data state, data (microinstructions) can be read from and written into the WCS Random Access Memory (RAM) by standard I/O instructions. The address of the location transferred is contained in the WCS Address Register. The WCS Address Register is automatically incremented by one after each pair of input or output instructions.

The data state is initiated by execution of a Set Control instruction to the WCS select code (SC):

STC SC

Two 16-bit words are required to transfer each 24-bit WCS word. Bits 7-0 of the first word transferred hold bits 23-16

of the WCS word. Bits 15-8 of the first word are not used. The second word holds bits 15-0 of the WCS word. The format of the word pair is the following:

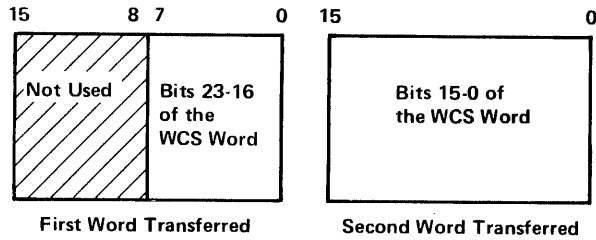

Thus, the WCS data requires a main memory buffer of up to 512 words per control memory module (2048 words to transfer the entire WCS contents).

PROGRAMMING EXAMPLES

The following Assembly language programs illustrate how to use the WCS facility.

LOADING WCS FROM MEMORY. The following program disables control memory operation and then loads the WCS with microinstructions stored in main memory.

Note: "SC" indicates the WCS select code.

CLC SC	Puts the WCS in the command state (readies the WCS to accept command).
LDA ADDR	Places the address of the first WCS location to be loaded in the A-register.
OTA SC	Sends the beginning WCS address to the WCS.
STC SC	Puts the WCS in the data state (readies WCS to accept data).
LOOP1 DLD BUFP,I	Places first word pair to be sent to WCS in the A- and B-registers.
ISZ BUFP	Increments main memory buffer pointer to next word pair.
ISZ BUFP	
OTA SC	Outputs first word to WCS.
OTB SC	Outputs second word to WCS.

ISZ COUNT Increments negative WCS word count; if 0, skip because load is complete.

JMP LOOP1 Repeats loop to load two more words.

READING WCS INTO MEMORY. The following program reads microinstructions stored in WCS and stores them in main memory.

CLC SC Puts WCS in command state.

LDA ADDR Places address of first WCS location to be read in the A-register.

OTA SC Sends the beginning address to the WCS.

STC SC Puts the WCS in the data state.

LOOP2 LIA SC Reads bits 23-16 of WCS location into bits 7-0 of the A-register.

LIB SC Reads bits 15-0 of WCS location into bits 15-0 of the B-register.

DST BUFP,I Stores two words (holding contents of single WCS location) into main memory buffer.

ISZ BUFP Increments main memory buffer pointer to next word pair.

ISZ BUFP

ISZ COUNT Increments negative WCS word count; if 0, skip because read is complete.

JMP LOOP2 Repeats loop to read the next WCS location.

SETTING BLOCK NUMBERS AND CONTROL MEMORY OPERATION. The following program assigns block numbers and, hence, control memory numbers to the WCS. Then the program enables the WCS for operation as control memory.

CLC SC Puts WCS in the command state.

LDA BLKN Places block numbers in the A-register.

OTB SC	Outputs to the WCS a relative address; the block numbers must be output in the second word.	CLC 2	Prepares DCPC channel 1 to receive the second DCPC control word.
OTA SC	Sends the block numbers from the A-register to the WCS.	LDA CW2	Gets the second DCPC control word from main memory and loads it into the A-register.
STF SC	Initiates control memory operation of WCS at T5 of this I/O instruction; address 0-511 become modules 10 and 11 and addresses 512-1023 become modules 4 and 5.	OTA 2	Sends the second DCPC control word to DCPC channel 1.
:		STC 2	Prepares the DCPC channel to receive the third DCPC word.
:		LDA CW3	Gets the third DCPC control word.
:		OTA 2	Sends the third DCPC control word to DCPC channel 1.
BLKN OCT 00205	This constant specifies that the first block is block number 5 and the second block is block number 2.	STC 6,C	Turns on the selected DCPC channel.
		STC 10	Starts the DCPC transfer.
		SFS 6	Tests for completion of the transfer.
		JMP *-1	Loops until transfer complete.
		:	
		:	

READING WCS INTO MEMORY USING DCPC. To read the WCS using the Dual Channel Port Controller (DCPC), replace LOOP2 in the Reading WCS into Memory Section with the DCPC initialization sequence. Issue the Set Control (STC) to the WCS select code *after* starting DCPC. DCPC will use every I/O cycle until the entire block of data is read from the WCS into main memory.

The STC and CLC options of DCPC (contained in Control Word 1) should not be utilized for transfers to/from WCS, as each STC or CLC reinitializes the WORD flip-flop.

Note that DCPC issues a CLF after each word transferred, disabling operation of the board as control memory.

The following program is an example of using DCPC channel 1 to read a block of 1000₈ words from the WCS on select code 10 into main memory starting at address 10,000₈.

CLC 10	Puts WCS in the command state.
LDA ADDR	Places address of first location to be read in the A-register.
OTA 10	Sends the beginning address to the WCS.
(LOOP2) LDA CW1	Gets the first DCPC control word from main memory and loads it into the A-register.
OTA 6	Sends the first DCPC control word to DCPC channel 1.

CW1	OCT 10	
CW2	OCT 110000	Specifies DCPC input and the starting address (10,000 ₈) of the block to be output.
CW3	OCT 177000	Specifies two's complement of the number (1000 ₈) of computer words to be transferred.

USING WCS AS MODULE 0

When attempting to use the WCS as module 0, special care must be taken when enabling and disabling the WCS operation because of the use of the IOG signal to select the address presented to the RAM's. When an I/O instruction is being executed referencing the WCS select code, the on-board address counter is selected to supply the RAM address; if not, then the Control Memory Address Register (CMAR) is selected to supply the RAM address. The two instructions STF and CLF, respectively, enable and disable WCS operation and cause the IOG signal to be as-

served. Thus, when executing a STF with WCS containing module 0 code, the IOG signal disappears at the same time that WCS becomes enabled. When trying to disable operation of WCS as module 0, there is a more troublesome problem. Here, as soon as IOG comes up when executing the CLF instruction to the board, the on-board address counter is selected to specify the RAM address. To avoid problems encountered by executing the microinstruction at the address contained in the on-board counter, the counter should be set to the address of some harmless microinstruction (such as a jump to FETCH) contained in WCS. When WCS is finally disabled, the base-set ROM's will again function, starting from the address specified in the CMAR.

3-4. GENERAL THEORY OF OPERATION

Writable Control Store (WCS) consists of a bipolar semiconductor Random Access Memory (RAM) containing 24 integrated-circuit (IC) packages mounted on a printed-circuit assembly (PCA). Also included is the flat jumper cable assembly necessary for complete mechanization within the computer. The WCS PCA should be installed only in slots 10 (standard), 11, and 12 of the computer I/O slots. Each IC package is configured in 1024 bits and organized as one bit per word. Thus, one module of WCS is capable of storing 1024 words of 24 bits each. For the purpose of execution of WCS instructions, WCS can be configured to be addressed as any four of the computer's control memory modules. Two WCS PCA's can be installed on an HP 2105 Computer. Three WCS PCA's can be installed on an HP 2108, 2109, 2111, 2112, 2113, or 2117 Computer.

WCS MODULE IDENTIFICATION

For proper addressing of WCS, an integrated-circuit comparator and two block number registers are used on the WCS PCA to identify the PCA as particular modules of control memory. For example, if the WCS board is configured for block 2, the PCA will be enabled when the Control Memory Address Register (CMAR) contains the pattern "000010" in its six most-significant bits (14-9), and will be disabled otherwise. When enabled, the word in WCS addressed by CMAR bits 8-0 will be sent to the Microinstruction Register (MIR) as signals ROM0 through ROM23. The computer will then execute this word (microinstruction as though it came from standard control memory.

WCS CONNECTION

WCS is connected to the computer CPU through the I/O structure (for loading and checking), and also through a 50-conductor ribbon cable connector. It is this connector that enables WCS to be used as an extension of the computer's basic control memory. The cable connects one, two or three WCS PCA's to the CPU PCA and the FAB in the HP 1000 E/F-Series. (In an M-Series, WCS connects to CPU and ROM PCA.) The CMAR on the CPU sends a 14-bit address (12-bit address in an M-Series) to the WCS PCA(s) through this cable and the addressed WCS then sends its data (microinstruction) from that address back through this cable to the MIR.

WCS ADDRESSING

The WCS Address Register determines which address is loaded or read while the WCS is in the data state. Thus, before loading or reading the WCS Random Access Memory, the WCS Address Register must be set. This is accomplished by sending the WCS address to the WCS while it is in the command state. Refer to section 3-3 for the explanation of how to set the WCS Address Register.

WCS OPERATION AS CONTROL MEMORY

Once loaded and enabled, WCS becomes an extension of control memory. Microprograms stored in the WCS are executed exactly as those stored in ROM. Since the WCS can be loaded via standard I/O instructions, it may be used to debug and store additions to the computer instruction set while the computer is in an operating condition. This feature permits dynamic expansion of the computer instruction set.

WCS TIMING DIAGRAM

Figure 3-3 illustrates the HP 13197A WCS timing.

NOTE

Pressing the PRESET switch on the operator panel, or executing the CLC 0 instruction, issues the CRS signal to all I/O boards installed in HP 1000 Series computers. The CRS signal disables all WCS boards from operation as control memory.

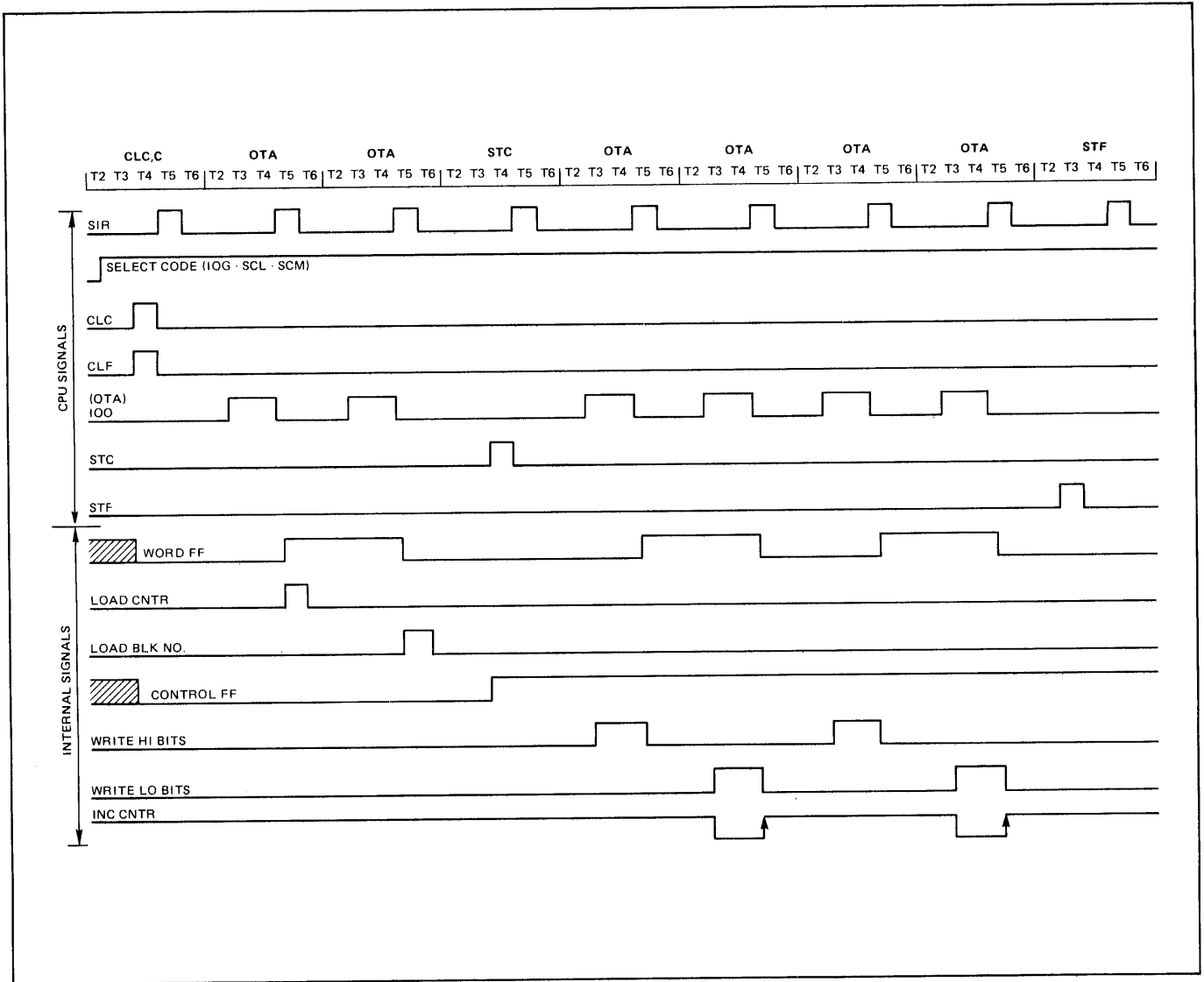

Figure 3-3. HP 13197A WCS Timing Diagram

HP 1000 E/F-SERIES DYNAMIC MAPPING SYSTEM

SECTION

IV

4-1. INTRODUCTION

This section provides installation instructions for the HP Dynamic Mapping System, which is an accessory for the HP 1000 E/F-Series Computers. Additional information is provided in the manuals listed in the Preface.

4-2. DESCRIPTION

The Dynamic Mapping System consists of the following hardware:

DESCRIPTION	HP PART NO.	HP PRODUCT NO.
Memory Expansion Module	12731-60001	12731A
Memory Protect PCA	12892-60003	12892B
4K ROM IC (bits 7-0)	13307-80033	13307B (Standard on E-Series)
4K ROM IC (bits 15-8)	13307-80034	
4K ROM IC (bits 23-16)	13307-80035	
8K ROM IC (bits 7-0)	5180-0141	F-Series (Standard)
8K ROM IC (bits 15-8)	5180-0142	
8K ROM IC (bits 23-16)	5180-0143	

REQUIRED HARDWARE

One of the following accessories is required for the installation of the three ROM ICs in the E/F-Series Computer:

- HP 13304A Firmware Accessory Board Kit for E-Series only
- HP 12791A Firmware Expansion Module for E- or F-Series.

The 12791A Firmware Expansion Module is standard in 2109E, 2113E, 2111F, and 2117F Ccomputers.

4-3. INSTALLATION

Install the memory expansion module (MEM) and memory protect PCA in the computer memory PCA cage as follows:

- On MEM, ensure that jumpers W1 through W4 are configured as shown in figure 4-1. The functions of these jumpers are described in table 4-1.
- On memory protect PCA, ensure that configuration jumper block U21 is configured as shown in figure 4-2.

- On the rear of the computer set the battery EXT/INT OFF switch to OFF.
- Switch the ~LINE ON/OFF switch to OFF, and disconnect the power cord.
- Remove memory PCA retainer and install memory expansion module, part no. 12731-60001, in slot 112.
- Install memory protect PCA, part no. 12892-60003, in slot 111; replace memory PCA retainer.

The three E-Series 4K ROM integrated circuits (ICs) are allocated to control store modules 32 and 33 (decimal) and can be installed on either the HP 13304A Firmware Accessory Board (FAB) or the HP 12791A Firmware Expansion Module (FEM). Install the ROM ICs as described in one of the following two procedures.

The three F-Series 8K ROM ICs are allocated to control store modules 32, 33, 34, and 35. These ROMs contain the DMI instructions and the Fast FORTRAN Processor instructions. These ROMs must be installed on the FEM. Refer to section VII of this manual for the installation of these ROMs.

FIRMWARE ACCESSORY BOARD

- Refer to section I of this manual for the FAB removal procedure.
- Install the following 4K ROM ICs in the specified sockets on the FAB and set the jumpers as shown below to correspond to Control Memory module 32 (decimal).

LOCATION	ROM IC	BITS	MODULE NO.
B1	13307-80033	7-0	} 32, 33
B2	13307-80034	15-8	
B3	13307-80035	23-16	

JUMPER

SETTING

10B	0
11B	0
12B	0
13	1

- Install the FAB following the procedures in section I.
- Perform verification as described in section 4-4.

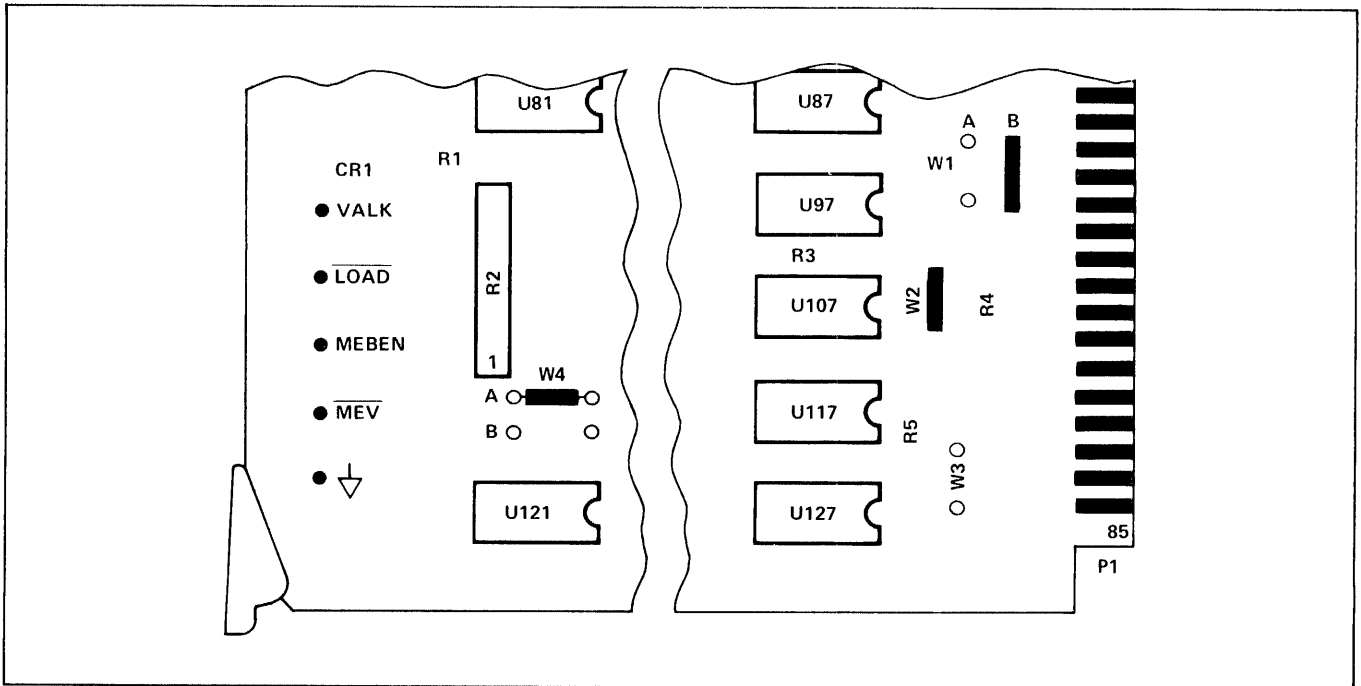

Figure 4-1. MEM Configuration Jumpers

Table 4-1. Memory Expansion Module Jumper Functions

JUMPER	DESCRIPTION
W1	<p>Plug-in jumper; selects computer compatibility as follows:</p> <p>W1 = A = HP 1000 M-Series Computer (2108/2112) W1 = B = HP 1000 E/F-Series Computer (2109/2113/2111/2117)</p>
W2	<p>Plug-in jumper; factory test only:</p> <p>W2 = IN = Normal operation W2 = OUT = Factory test</p>
W3	<p>Hardwired jumper; factory test only:</p> <p>W3 = IN = Factory test W3 = OUT = Normal operation</p>
W4	<p>Hardwired jumper: Reset Memory Expansion Module.</p> <p>With the Memory Protect enabled and the computer issues IAK (Interrupt Acknowledge) in response to an IRQ (Interrupt Request), Memory Protect is turned off and the Memory Expansion Module (MEM) is switched automatically to the System Map. If an I/O instruction is in the trap cell allocated to the interrupting device, Memory Protect is turned back on and asserts the RME signal which controls the following:</p> <p>W4 = A = MEM remains in System Map. W4 = B = MEM returns to same map in use prior to IAK being issued.</p> <p>Note: MEM jumper W4 and Memory Protect RME jumper <i>must</i> be configured alike to respond to the RME signal. That is, if the Memory Protect RME jumper is OUT, MEM jumper W4 must be in position "A"; if the Memory Protect RME jumper is IN, MEM jumper W4 must be in position "B".</p>

FIRMWARE EXPANSION MODULE

- a. Refer to section II of this manual for FEM removal procedure.
- b. The three DMI ROMs can be installed in any available socket set on the FEM. For example, assume we are going to install the ROMs in SET A. Refer to figure 2-1 for location of the sockets.

LOCATION	ROM IC	BITS	MODULE NO.
A1	13307-80033	7-0	} 32, 33
A2	13307-80034	15-8	
A3	13307-80035	23-16	

- c. Configure the SET A control memory address switches, SWA, for modules 32 and 33. See figure 2-1 and table 2-1 for reference.

SWITCH	SWA	SETTING
S1		1
S2		0
S3		0
S4		1
S5		1
S6		1
S7		0
S8		0
S9		0
S10		0

- d. Refer to section II of this manual for the FEM installation procedure
- e. Perform verification as described below.

4-4. VERIFICATION

Verify the Dynamic Mapping System operation by running the following diagnostics:

<u>DIAGNOSTIC</u>	<u>MANUAL</u>	<u>ABSOLUTE BINARY NO.</u>
Memory Protect-Parity Error Test	12892-90005	12892-16001
Memory Expansion Module Test	12929-90003	12929-16001

If the diagnostic tests are completed without an error halt, the DMS is operating correctly. If the tests indicate an error halt, refer to the FAB section or FEM for troubleshooting information. If trouble still persists, contact your nearest HP Sales and Service Office. (A list of HP Sales and Service Offices is given in the *HP 1000 E/F-Series Computer Operating and Reference Manual*, and the *HP 1000 E/F-Series Computer Installation and Service Manual*.)

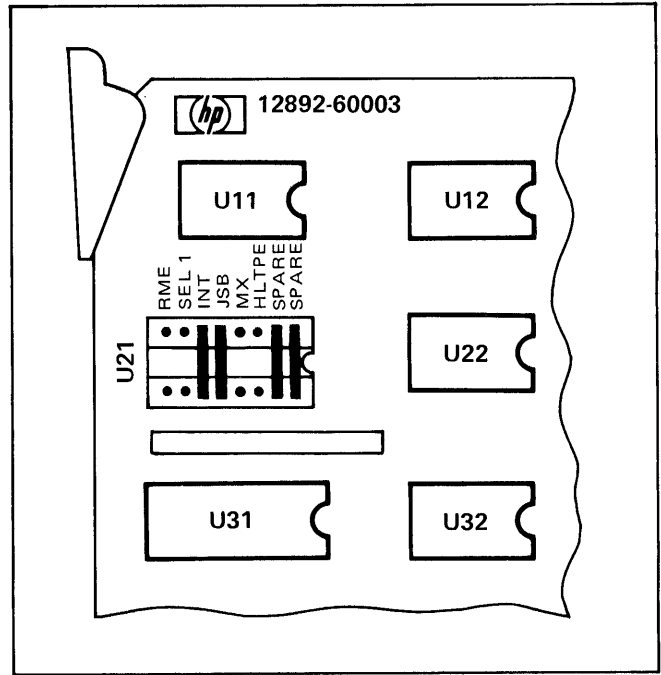

Figure 4-2. Memory Protect Configuration Jumpers

HP RTE IV A/B EXTENDED MEMORY AREA FIRMWARE

SECTION

V

5-1. INTRODUCTION

This section provides installation instructions for the HP Extended Memory Area (EMA) Firmware. This firmware is to be installed in an E-Series Computer or an F-Series Computer for use with RTE IV A/B: Additional information is provided in the manuals listed in the Preface.

5-2. DESCRIPTION

The HP EMA firmware consists of three 4K ROMs that are installed on the FAB board or FEM board. The firmware routines handle map switching (if required) and addressing to data words located in extended memory.

The HP EMA firmware consists of the following:

DESCRIPTION	PART NO.
4K ROM IC (Bits 23-16)	92067-80003
4K ROM IC (Bits 15-8)	92067-80002
4K ROM IC (Bits 7-0)	92067-80001

5-3. INSTALLATION

The three EMA ROMs can be installed on the HP 13304A Firmware Accessory Board (FAB) or the HP 12791A Firmware Expansion Module (FEM). If a FEM with an unused block of sockets is available, it may be desirable to install the ROMs on the FEM to facilitate future access to the ROMs.

FIRMWARE ACCESSORY BOARD

- Refer to section I of this manual for the FAB removal procedure.
- Install the following ROM ICs in the specified sockets on the FAB and set the jumpers to correspond to Control Memory modules 36 and 37.

NOTE

Sockets C1 through C3 are recommended for the EMA firmware location, due to location requirements of other HP firmware accessories, such as the HP 13306B Fast Fortran Processor.

If DS/1000 ROMs, part numbers 91740-80067, 91740-80068, and 91740-80069,

are presently installed on the FAB board, they should be residing in the MSMP of blocks B, C, or D. For this case, the EMA ROMs should be installed in the LSMP of this block. For example, if DS/1000 ROMs are occupying C4, C5, and C6, then the EMA ROMs should be installed in sockets C1, C2, and C3 (refer to the table below and figure 1-2 to associate each EMA ROM with the appropriate socket).

LOCATION	ROM IC	BITS	MODULE NO.
B1 (XU401) C1 (XU201) D1 (XU101)	92067-80001 (EMA ROM)	7-0	} 36, 37
B2 (XU402) C2 (XU202) D2 (XU102)	92067-80002 (EMA ROM)	15-8	
B3 (XU404) C3 (XU202) D3 (XU104)	92067-80003 (EMA ROM)	23-16	
B4 (XU406) C4 (XU206) D4 (XU106)	91740-80067 (DS/1000 ROM)	7-0	} 38, 39
B5 (XU408) C5 (XU208) D5 (XU108)	91740-80068 (DS/1000 ROM)	15-8	
B6 (XU409) C6 (XU209) D6 (XU109)	91740-80069 (DS/1000 ROM)	23-16	

- Set jumpers 10 through 13 as shown in below. Jumper notations A, B, C, and D correspond to blocks A, B, C, and D respectively.

JUMPER	SETTING
10C	1
11C	0
12C	0
13	1

- Refer to section I of this manual for the FAB installation procedure.
- Perform the verification as described in section 5-4.

FIRMWARE EXPANSION MODULE

- a. Refer to section II of this manual for the FEM removal and installation procedure.
- b. Install the three ROM ICs in any available set of sockets and configure the switches as shown in table 2-1 for Control Memory modules 36 and 37. The following are the switch settings for control memory modules 36 and 37.

<u>SWITCH</u>	<u>SETTING</u>
S1	1
S2	0
S3	0
S4	1
S5	1
S6	1
S7	0
S8	0
S9	1
S10	0

- c. Refer to section II for the FEM installation procedure.
- d. Perform verification as described below.

5-4. VERIFICATION

Installation

After installing the EMA ROMs, verify correct installation by running the EMA self-test. The EMA self-test

checks for correct IC orientation and correct EMA firmware addressing.

To execute the EMA self-test proceed as follows:

- a. Store 105242 (octal) in the A-Register.
- b. Store 0 in the P-Register.
- c. Store 0 in the S-Register.
- d. Press PRESET.
- e. Press INSTR STEP.

If the EMA self-test completes with the S-Register equal to 102077 then the firmware is operational. If the test completes with the S-Register NOT EQUAL to 102077, then check for the following conditions:

- a. Incorrect IC orientation on the FAB or FEM.
- b. Incorrect jumper positioning on the FAB board, or switch settings on the FEM.
- c. IC pin(s) are bent under or broken off.

If a failure still exists, refer to the Service Information paragraph of the FAB or FEM section of this manual for troubleshooting procedures.

Operation

To verify functional operation of the EMA firmware, the EMA on-line diagnostic should be run. Refer to the EMA On-Line Diagnostic Reference Manual, part number 92067-90007, for operating instructions. Follow the troubleshooting procedures recommended in the EMA On-Line Diagnostic Reference Manual if a failure exists.

HP 13306B FAST FORTRAN PROCESSOR FIRMWARE

**SECTION
VI**

6-1. INTRODUCTION

This section provides installation instructions for the HP 1000 Fast FORTRAN Processor firmware, which is an accessory for the HP 1000 E-Series Computer. Additional information is provided in the manuals listed in the Preface.

6-2. DESCRIPTION

The HP 1000 Fast FORTRAN Processor (FFP) firmware consists of six read-only-memory (ROM) integrated-circuits (IC's). Three 4K ROM IC's are allocated to control memory module 32 and 33 (decimal) and three 4K ROM IC's are allocated to control memory modules 34 and 35 (decimal).

E-Series computers with a serial prefix of 21xx or greater contain the ROMs listed below under option 100 as a standard part of the computer.

13306B standard includes:

<u>DESCRIPTION</u>	<u>HP PART NO.</u>
4K ROM IC (Bits 7-0)	5090-0589
4K ROM IC (Bits 15-8)	5090-0590
4K ROM IC (Bits 23-16)	5090-0591

Option 100 adds the following three ROMs:

4K ROM IC (Bits 7-0)	13307-80033
4K ROM IC (Bits 15-8)	13307-80034
4K ROM IC (Bits 23-16)	13307-80035

6-3. INSTALLATION

The HP 13304A Firmware Accessory Board or HP 12791A Firmware Expansion Module is required for the installation of the six FFP ROM IC's.

FIRMWARE ACCESSORY BOARD

- Refer to section I of this manual for removal of the FAB.
- On the FAB, install the six ROM IC's in the following locations (see figure 1-2):

<u>LOCATION</u>	<u>ROM IC</u>	<u>BITS</u>	<u>MODULE NO.</u>
B1 (XU401)	13307-80033	7-0	} 32, 33
B2 (XU402)	13307-80034	15-8	
B3 (XU404)	13307-80035	24-16	
B4 (XU406)	5090-0589	7-0	} 34, 35
B5 (XU408)	5090-0590	15-8	
B6 (XU409)	5090-0591	24-16	

Ensure that the IC's are oriented correctly as shown in figure 1-2 by matching pin 1 of each IC with the white dot on each IC socket.

- Configure the control store module address jumpers for modules 32, 33, 34, and 35 as shown below. Figures 1-1 and 1-2 can be used for reference.

<u>JUMPER</u>	<u>SETTING</u>
10B	0
11B	0
12B	0
13	1

- Refer to section I for the FAB installation procedure.
- Perform verification as described below.

FIRMWARE EXPANSION MODULE

- Refer to section II of this manual for the FEM removal procedure.
- The six FFP ROMs can be installed in any available socket sets on the FEM. For example, assume we are going to install the ROMs in SET A and SET B. Refer to figure 2-1 for location of the sockets.

<u>LOCATION</u>	<u>ROM IC</u>	<u>BITS</u>	<u>MODULE NO.</u>
A1	13307-80033	7-0	} 32, 33
A2	13307-80034	15-8	
A3	13307-80035	23-16	
B1	5090-0589	7-0	} 34, 35
B2	5090-0590	15-8	
B3	5090-0591	23-16	

- Configure the SET A and SET B control memory address switches, SWA and SWB for modules 32, 33 and 34, 35 respectively. See figure 2-1 and table 2-1 for reference.

<u>SWA</u>		<u>SWB</u>	
<u>SWITCH</u>	<u>SETTING</u>	<u>SWITCH</u>	<u>SETTING</u>
S1	1	S1	1
S2	0	S2	0
S3	0	S3	0
S4	1	S4	1
S5	1	S5	1
S6	1	S6	1
S7	0	S7	0
S8	0	S8	0
S9	0	S9	0
S10	0	S10	1

FFP

- d. Refer to section II of this manual for the FEM installation procedure.
- e. Perform the verification as described below.

6-4.

After installing the FFP, verify proper operation by performing the Fast FORTRAN Processor diagnostic test de-

scribed in the *Diagnostic Reference Manual*. Part numbers for the diagnostic test are as follows:

<u>DIAGNOSTIC</u>	<u>MANUAL</u>	<u>ABSOLUTE BINARY PROGRAM NO.</u>
Fast FORTRAN Processor	12977-90002	12997-16004 12977-16005

If the diagnostic test is completed without an error halt, the FFP is operating correctly. If the diagnostic test indicates an error halt, refer to the FAB or FEM section of this manual for troubleshooting information.

HP 1000 F-SERIES DYNAMIC MAPPING INSTRUCTIONS AND FAST FORTRAN PROCESSOR FIRMWARE

SECTION

VII

7-1. INTRODUCTION

This section provides installation and reference information for the F-Series Dynamic Mapping Instructions and Fast FORTRAN Processor. Additional information is provided in the manuals listed in the Preface.

7-2. DESCRIPTION

The F-Series DMI/FFP consists of three 8K read-only-memory (ROM) integrated-circuits (IC's). The DMI instructions are contained within these three ROMs.

<u>DESCRIPTION</u>	<u>HP PART NO.</u>
8K ROM IC (Bits 7-0)	5180-0141
8K ROM IC (Bits 15-8)	5180-0142
8K ROM IC (Bits 23-16)	5180-0143

7-3. INSTALLATION

The F-Series DMI/FFP ROMs are standard on the F-Series Computer. They are installed on the HP 12791A Firmware Expansion Module (FEM). To install or remove the DMI/FFP ROMs, proceed as follows.

- Refer to section II of this manual for the FEM removal procedure.
- The three ROM IC's can be installed in any vacant socket set. For example, assume we will use SETA.

<u>LOCATION</u>	<u>ROM IC</u>	<u>BITS</u>	<u>MODULE NO.</u>
A1	5180-0141	7-0	32, 33, 34, 35
A2	5180-0142	15-8	
A3	5180-0143	23-16	

- Configure control memory address switches SWA for modules 32, 33, 34, and 35 as shown below. Figures 2-1 and 2-2 can be used for reference.

<u>SWITCH</u>	<u>SETTING</u>
S1	1
S2	0
S3	1
S4	0
S5	1
S6	1
S7	0
S8	0
S9	0
S10	X (Don't care)

- Refer to section II for the FEM installation procedure.
- Perform verification as described below.

7-4. VERIFICATION

INSTALLATION

After installing the DMI/FFP ROMs, verify proper installation by running the firmware self-test. The firmware self-test checks for correct IC orientation and if the DMI/FFP firmware is correctly addressed.

To execute the FFP self-test proceed as follows:

- Store 105200 (octal) in the A-register.
- Store 0 in the P-register.
- Press PRESET.
- Press INSTR STEP.

One of three results should be displayed in the S-register:

- S = 102077 indicates successful completion.

DMS/FFP

- b. S = 102001 indicates module 33 defective or missing.
- c. S = 102002 indicates module 35 defective or missing.

Any other indication in the S-register indicates that DMI/FFP is defective or not installed properly. If other than a 102077B is displayed on the S-register, check for the following conditions.

- a. Incorrect IC orientation on the FEM.
- b. Incorrect switch settings on the FEM.
- c. IC pin(s) are bent under or broken off.

If a failure still exists, refer to the Service Information paragraph of the FEM section of this manual (section I) for troubleshooting procedure.

OPERATION

To verify functional operation of the DMI/FFP firmware, the FFP/Floating Point Processor/Scientific Instruction Set and the Memory Expansion Module off-line diagnostics should be run. Refer to the appropriate Diagnostic Reference Manual for execution procedure.

<u>DIAGNOSTIC</u>	<u>MANUAL</u>	<u>ABSOLUTE BINARY NO.</u>
Floating Point Processor/ Scientific Instruction Set/ Fast FORTRAN Processor	12740-90004	12740-16001
Memory Expansion Module Test	12929-90003	12929-16001

If the diagnostic test is complete without an error halt, the DMI/FFP is operating correctly. If the diagnostic test indicates an error halt, refer to the FEM section of this manual for troubleshooting information.

HP 1000 F-SERIES SCIENTIFIC INSTRUCTION SET FIRMWARE

SECTION

VIII

8-1. INTRODUCTION

This section provides installation and reference information for the F-Series Scientific Instruction Set (SIS) firmware. Additional information is provided in the manuals listed in the Preface.

8-2. DESCRIPTION

The Scientific Instruction Set (SIS) firmware consists of six read-only-memory (ROM) integrated-circuits (IC's). The three ROMs are allocated to control memory modules 40, 41, 42, and 43 as follows:

<u>DESCRIPTION</u>	<u>HP PART NO.</u>
8K ROM IC (Bits 7-0)	12823-80019
8K ROM IC (Bits 15-8)	12823-80020
8K ROM IC (Bits 23-16)	12823-80021

8-3. INSTALLATION

The F-Series SIS ROMs are standard on the F-Series Computer. They are installed on the HP 12791A Firmware Expansion Module. To install or remove the SIS ROMs, proceed as follows.

- Refer to section II of this manual for the FEM removal procedure.
- The three SIS ROMs can be installed in any vacant socket set. For example, assume we will use SETA. Refer to figure 2-2 in section II for socket locations.

<u>LOCATION</u>	<u>ROM IC</u>	<u>BITS</u>	<u>MODULE NO.</u>
A1	12823-80019	7-0	} 40, 41, 42, 43
A2	12823-80020	15-8	
A3	12823-80021	23-16	

- Configure control memory address switches SWA for modules 40, 41, 42, and 43 as shown below. Figures 2-1 and 2-2 can be used for reference.

<u>SWITCH</u>	<u>SETTING</u>
S1	1
S2	0
S3	1
S4	0
S5	1
S6	1
S7	0
S8	1
S9	0
S10	X (Don't care)

- Refer to section II of this manual for the FEM installation procedure.
- Perform verification as described below.

8-4. VERIFICATION

INSTALLATION

After installing the SIS ROMs, verify proper installation by running the firmware self-test. The firmware self-test checks for correct IC orientation and correct SIS firmware addressing.

To execute the SIS self-test proceed as follows:

- Store 105337 (octal) in the A-register.
- Store 0 in the P-register.
- Press RESET.
- Press INSTR STEP.

A 102077 (octal) in the S-register indicates successful completion. Any other value displayed in the S-register indicates the SIS firmware self test failed. Refer to the Service Information paragraph of the FEM section of this manual (section II) for troubleshooting procedure.

S = 102001 Indicates floating point PCA's not cabled or not powered.

S = 102002 Indicates a numerical error in the diagnostic calculation; defective floating point PCA(s) or ROMs.

DIAGNOSTIC

MANUAL

ABSOLUTE
BINARY NO.

Floating Point Processor/
Scientific Instruction Set/
Fast FORTRAN Processor

12740-90004

12740-16001

OPERATION

To verify functional operation of the SIS firmware, the FPP/SIS/FFP off-line diagnostic should be run. Refer to the FPP/SIS/FFP Diagnostic Reference Manual for execution procedure.

If the diagnostic test is completed without an error halt, the SIS is operating correctly. If the diagnostic test indicates an error halt, refer to the Service Information paragraph of the FEM section of this manual (section II) for troubleshooting procedure.

HP 12824A/29A VECTOR INSTRUCTION SET FIRMWARE

SECTION

IX

9-1. INTRODUCTION

This section provides installation and reference information for the HP 12824A/29A Vector Instruction Set (VIS) firmware, which is an option for the F-Series Computer. Additional information is provided in the manuals listed in the Preface.

9-2. DESCRIPTION

The Vector Instruction Set (VIS) firmware consists of three read-only-memory (ROM) integrated-circuits (IC's) the three ROMs are allocated to control memory modules 12, 13, 14, and 15.

<u>DESCRIPTION</u>	<u>HP PART NO.</u>
8K ROM IC (Bits 7-0)	12824-80007
8K ROM IC (Bits 15-8)	12824-80008
8K ROM IC (Bits 23-16)	12824-80009

The 12791A Firmware Expansion Module is an accessory which is required for the installation of the three 8K ROMs in a F-Series Computer.

9-3. INSTALLATION

The VIS ROMs are installed on the 12791A Firmware Expansion Module (FEM). To install or remove the three VIS ROMs, proceed as follows.

- Refer to section II of this manual for the FEM removal procedure (if necessary).
- The three VIS ROMs can be installed in any available socket set on the FEM. For example, assume we are going to install the ROMs in SETA. Refer to figure 2-1 for location of the sockets.

<u>LOCATION</u>	<u>ROM IC</u>	<u>BITS</u>	<u>MODULE NO.</u>
A1	12824-80007	7-0	} 12, 13, 14, 15
A2	12824-80008	15-8	
A3	12824-80009	23-16	

- Configure the SETA control memory address switches, SWA, for modules 12, 13, 14, and 15. Refer to figure 2-1 and table 2-1 for reference.

<u>SWITCH</u>	<u>SWA</u>	<u>SETTING</u>
S1		1
S2		0
S3		1
S4		0
S5		1
S6		0
S7		0
S8		1
S9		1
S10		X (Don't care)

- Refer to section II of this manual for the FEM installation procedure.
- Perform verification as described below.

9-4. VERIFICATION

Installation

After installing the VIS ROMs, verify proper installation by running the VIS firmware self-test. The firmware self test checks for correct IC orientation and correct VIS firmware addressing.

To execute the VIS self-test proceed as follows:

- Store 105477 (octal) in the A-register.
- Store 0 in the P-register.
- Press PRESET.
- Press INSTR STEP.

A 102077 (octal) in the S-register indicates successful completion. Any other value displayed in the S-register indicates the VIS firmware self-test failed. Refer to the Service Information paragraph of the FEM section of this manual (section II) for troubleshooting procedure.

Operation

To verify functional operation of the VIS firmware, the VIS on-line diagnostic should be run. Refer to the *VIS Users Manual*, part number 12824-90001, for operating instructions. Troubleshooting procedures are recommended in the FEM section of this manual.

HP 91740B DISTRIBUTED SYSTEM FIRMWARE

SECTION

X

10-1. INTRODUCTION

This section provides quick reference information for the HP 91740B E/F-Series Distributed System (DS/1000) Firmware. Complete installation information can be found in the *HP 91740B Distributed System (DS/1000) Firmware Installation Manual*, part no. 91740-90009, which is supplied with the product. Additional information is provided in the manuals listed in the Preface.

10-2. DESCRIPTION

The HP 91740B Firmware consists of one DS/1000 Communications Bootstrap Loader (CBL) ROM and three DS/1000 Driver Microcode ROM's. The CBL is an Initial Binary Loader (IBL) that is installed in one of the loader ROM sockets on the Central Processing Unit (CPU) PCA. The driver ROM's contain a microprogram that allows communication between other Hewlett-Packard computers that are equipped with DS/1000 and the appropriate communication interfaces. These driver ROM's are installed on the HP 13304A Firmware Accessory Board

(FAB). The HP part numbers for the HP 91740B Firmware are as follows:

DESCRIPTION	HP PART NO.
CBL ROM	
1k ROM IC	91740-80048
DRIVER MICROCODE ROM's	
4k ROM IC (Bits 7-0)	91740-80067
4k ROM IC (Bits 15-8)	91740-80068
4k ROM IC (Bits 23-16)	91740-80069

10-3. INSTALLATION

A loader ROM socket on the CPU board is required for installation of CBL ROM (Figure 10-1). The HP 13304A Firmware Accessory Board is required for installation of the three driver microcode ROM's. These ROM's should be installed in the MSMP (most significant module pair) of block C.

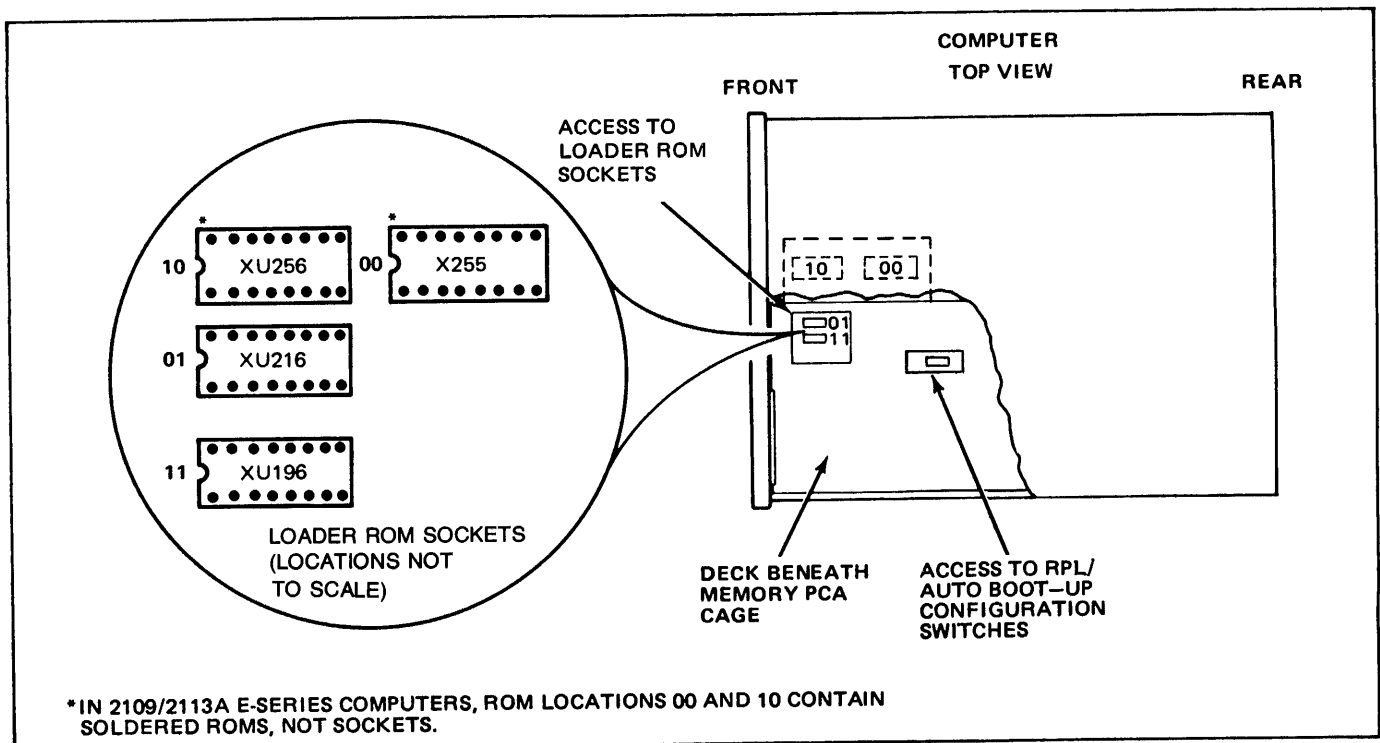

- a. Install the CBL ROM in loader ROM socket 11 in an A-Model computer (2109A, 2113A), or in socket 10 or 11 in a 2109B/E, 2113B/E, 2111F, or 2117F model computer.
- b. Refer to section I of this manual for the FAB removal procedure.
- c. Due to the allocations of the FAB for other HP optional firmware, and that the DS/1000 driver microcode operates in a most significant module pair (MSMP) block, the DS/1000 ROMs should be installed in the following locations. Refer to figure 1-2 in section I for socket locations.

LOCATION	ROM IC	BITS	MODULE NO.
C4 (XU106)	91740-80067	7-0	} 38,39
C5 (XU108)	91740-80068	15-8	
C6 (XU109)	91740-80069	23-16	

- c. Configure control memory address jumpers for modules 38 and 39 as shown below. Refer to figures 1-1 and 1-2 for location of jumper and settings.

JUMPER	SETTING
10C	1
11C	0
12C	0
13	1

- d. Refer to section I of this manual for the FAB installation procedure.
- e. Perform verification as described below.

10-4. VERIFICATION

After reinstalling the computer in your system, verify correct DS/1000 Firmware installation by running the DS/1000 Self-Test. The DS/1000 Self-Test checks for correct IC orientation and correct DS/1000 firmware addressing.

To execute the DS/1000 Self-Test proceed as follows:

- a. Press < Register Select >, as required, to select the S-register for display in the Display Register. The light associated with the S-register will be on, once the S-register is selected.
- b. Press CLEAR DISPLAY to clear the contents of the Display Register. If the CBL ROM was installed in

loader socket 11₂ (XU196), press switches 14 and 15. If the CBL ROM was installed in loader socket 10₂ (XU256), press switch 15. This sets the bits in the Display Register which selects the CBL ROM.

- c. Set bits 6 through 11 of the Display Register to the select code of the DS/1000 communications interface. The select code corresponds to the octal number marked on the computer chassis adjacent to the card slot containing the DS/1000 communications interface card. If a system contains multiple DS/1000 communications PCA's, choose the select code of the primary downloading PCA.
- d. Press STORE.
- e. Press PRESET and then IBL/TEST. Do NOT press RUN!
- f. Press < Register Select >, as required, to select the P-register. Do NOT clear the display. Press switches 3, 4, and 5 to set bits 3, 4, and 5 in the Display Register. Press STORE.
- g. Press RUN.

If the DS/1000 CBL ROM and Driver Microcode ROM's are installed properly, the RUN light will remain lit and the Display Register will indicate the date code of the installed firmware. If the Display Register is partitioned into four equal sections (Table 10-1) with each section representing a BCD digit (bits 15-12 representing the most significant digit), the number displayed corresponds to the approximate release time of this firmware.

If the Display Register indicates 10205₈, the RUN light is off, and the T-register select light is on, then the CBL ROM is installed properly; but, a problem concerning the DS/1000 Driver Microcode ROM's has been detected. The FAB assembly should be removed and inspected for the following:

- a. Incorrect ROM IC orientation.
- b. Incorrect jumper positioning.
- c. Bent or broken ROM IC pin(s).
- d. Incorrect 4K ROM IC part numbers.
- e. Damaged parts.

If the Display Register contains any other value, the CBL ROM should be inspected for the following.

- a. Incorrect orientation.
- b. Bent or broken pin(s).

- c. Incorrect part number. Also, other Display Register values may result from a CPU failure.

If these inspections locate a problem, correct it and run the DS/1000 Self-Test again. If the failure still exists, isolate the faulty ROM IC(s) by substituting a good ROM IC(s). If failure still exists, contact your nearest Hewlett-Packard Sales and Service Office. A list of HP Sales and Service Offices is provided in your Computer Installation and Service Manual.

To perform verification without a CBL ROM installed, proceed as follows:

- a. Select the A-Register and set it as follows:
E/F-Series = 105304 octal
- b. Set the P and S-Registers to 0.
- c. Press PRESET and INSTR STEP.
- d. If the firmware passes the self-test, the S-Register will display the date code in BCD as shown in table 10-1.

This firmware requires that the software communications driver (%DVA65, HP Part Number 91740-16071) must be revision level 1805 or later.

Refer to *Network Manager's Manual*, part no. 91740-90003 for generation and operating procedures.

Table 10-1. Display Register with Self-Test Passed

BCD	2			0			0			3							
LAMPS ON BITS	☆															☆	☆
	15	14	13	12	11	10	9	8	7	6	5	4	3	2	1	0	
OCTAL	0	2			0			0			0			3			

M/E/F-SERIES CONTROL MEMORY ALLOCATION

SECTION

XI

11-1. CONTROL MEMORY MAPS

This section contains the Control Memory allocation for HP 1000 M/E/F-Series computers.

CONTROL MEMORY MODULE ALLOCATION	MODULE NO.	ADDRESS		SOFTWARE ENTRY POINT	
		DECIMAL	OCTAL		
HP BASE SET HP DYNAMIC MAPPING INSTRUCTIONS →	0	0-00255	00000-00377	YES	-1K
	1	00256-00511	00400-00777	YES	
	2	00512-00767	01000-01377	YES	
HP FAST FORTRAN PROCESSOR	3	00768-01023	01400-01777	YES	-2K
	4	01024-01279	02000-02377	YES	
	5	01280-01535	02400-02777	YES	
HP RESERVED	6	01536-01761	03000-03377	YES	-3K
	7	01762-02047	03400-03777	YES	
DS/1000	8	02048-02303	04000-04377	YES	-4K
	9	02304-02559	04400-04777	YES	
RECOMMENDED FOR USER MICROPROGRAMMING	10	02560-02815	05000-05377	YES	
	11	02816-03071	05400-05777	YES	
HP BASE SET	12	03072-03327	06000-06377	YES	
	13	03328-03583	06400-06777	YES	
HP BASE SET	14	03584-03849	07000-07377	YES	
	15	03850-04095	07400-07777	YES	

Figure 11-1. M-Series Control Memory Map

CONTROL MEMORY MAPS

CONTROL MEMORY MODULE ALLOCATION	MODULE NO.	ADDRESS		SOFTWARE ENTRY POINT		
		DECIMAL	OCTAL			
HP BASE SET	0	0-00255	00000-00377	YES	1K	
	1	00256-00511	00400-00777	YES		
	2	00512-00767	01000-01377	YES		
	3	00768-01023	01400-01777	YES		
AVAILABLE FOR USER MICROPROGRAMMING	4	01024-01279	02000-02377	NO	2K	
	5	01280-01535	02400-02777	NO		
	6	01536-01761	03000-03377	NO		
	7	01762-02047	03400-03777	NO		
	8	02048-02303	04000-04377	NO		3K
	9	02304-02559	04400-04777	NO		
	10	02560-02815	05000-05377	NO		
AVAILABLE FOR USER MICROPROGRAMMING	11	02816-03071	05400-05777	NO	4K	
	12	03072-03327	06000-06377	NO		
	13	03328-03583	06400-06777	NO		
	14	03584-03849	07000-07377	NO		
AVAILABLE FOR USER MICROPROGRAMMING	15	03850-04095	07400-07777	NO	5K	
	16	04096-04351	10000-10377	NO		
	17	04352-04607	10400-10777	NO		
	18	04608-04863	11000-11377	NO		
AVAILABLE FOR USER MICROPROGRAMMING	19	04864-05119	11400-11777	NO	6K	
	20	05120-05375	12000-12377	NO		
	21	05376-05631	12400-12777	NO		
	22	05632-05887	13000-13377	NO		
AVAILABLE FOR USER MICROPROGRAMMING	23	05888-06143	13400-13777	NO	7K	
	24	06144-06399	14000-14377	NO		
	25	06400-06655	14400-14777	NO		
	26	06656-06911	15000-15377	NO		
AVAILABLE FOR USER MICROPROGRAMMING	27	06912-07167	15400-15777	NO	8K	
	28	07168-07423	16000-16377	NO		
	29	07424-07679	16400-16777	NO		
	30	07680-07935	17000-17377	NO		
HP DYNAMIC MAPPING SYSTEM	31	07936-08191	17400-17777	NO		
HP FAST FORTRAN PROCESSOR	32	08192-08447	20000-20377	YES	9K	
	33	08448-08703	20400-20777	NO		
	34	08704-08959	21000-21377	YES		
	35	08960-09215	21400-21777	YES		
RTE-IV EMA OR RTE-6/VM EMA/VMA DS/1000	36	09216-09571	22000-22377	YES	10K	
	37	09572-09727	22400-22777	YES		
	38	09728-09983	23000-23377	YES		
	39	09984-10239	23400-23777	YES		
HP RESERVED	40	10240-10495	24000-24377	YES	11K	
	41	10496-10751	24400-24777	NO		
	42	10752-10917	25000-25377	NO		
	43	10918-11263	25400-25777	NO		
RTE-6/VM OPERATING SYSTEM	44	11264-11519	26000-26377	YES	12K	
	45	11520-11775	26400-26777	YES		
	46	11776-12031	27000-27377	YES		
	47	12032-12287	27400-27777	YES		
RECOMMENDED FOR USER MICROPROGRAMMING	48	12288-12543	30000-30377	YES	13K	
	49	12544-12799	30400-30777	YES		
	50	12800-13055	31000-31377	YES		
	51	13056-13311	31400-31777	NO		
RECOMMENDED FOR USER MICROPROGRAMMING	52	13312-13557	32000-32377	NO	14K	
	53	13558-13823	32400-32777	NO		
	54	13824-14079	33000-33377	NO		
	55	14080-14335	33400-33777	NO		
RECOMMENDED FOR USER MICROPROGRAMMING	56	14336-14591	34000-34377	YES	15K	
	57	14592-14847	34400-34777	YES		
	58	14848-15103	35000-35377	YES		
	59	15104-15359	35400-35777	YES		
RECOMMENDED FOR USER MICROPROGRAMMING	60	15360-15615	36000-36377	YES	16K	
	61	15616-15871	36400-36777	NO		
	62	15872-16127	37000-37377	YES		
	63	16128-16383	37400-37777	NO		

Figure 11-2. E-Series Control Memory Map

CONTROL MEMORY MODULE ALLOCATION	MODULE NO.	ADDRESS		SOFTWARE ENTRY POINT	
		DECIMAL	OCTAL		
HP BASE SET	0	0-00255	00000-00377	YES	1K
	1	00256-00511	00400-00777	YES	
	2	00512-00767	01000-01377	YES	
HP RESERVED	3	00768-01023	01400-01777	YES	2K
	4	01024-01279	02000-02377	YES	
	5	01280-01535	02400-02777	NO	
	6	01536-01761	03000-03377	NO	
VECTOR INSTRUCTION SET	7	01762-02047	03400-03777	NO	3K
	8	02048-02303	04000-04377	YES	
	9	02304-02559	04400-04777	NO	
RTE-6/VM OPERATING SYSTEM	10	02560-02815	05000-05377	NO	4K
	11	02816-03071	05400-05777	NO	
	12	03072-03327	06000-06377	YES	
HP RESERVED	13	03328-03583	06400-06777	NO	5K
	14	03584-03849	07000-07377	NO	
	15	03850-04095	07400-07777	NO	
	16	04096-04351	10000-10377	YES	
HP RESERVED	17	04352-04607	10400-10777	NO	6K
	18	04608-04863	11000-11377	YES	
	19	04864-05119	11400-11777	NO	
AVAILABLE FOR USER MICROPROGRAMMING	20	05120-05375	12000-12377	YES	7K
	21	05376-05631	12400-12777	NO	
	22	05632-05887	13000-13377	NO	
	23	05888-06143	13400-13777	NO	
HP DYNAMIC MAPPING SYSTEM	24	06144-06399	14000-14377	NO	8K
	25	06400-06655	14400-14777	NO	
	26	06656-06911	15000-15377	NO	
HP FAST FORTRAN PROCESSOR	27	06912-07167	15400-15777	NO	9K
	28	07168-07423	16000-16377	NO	
	29	07424-07679	16400-16777	NO	
RTE-IV EMA OR RTE-6/VM EMA/VMA DS/1000	30	07680-07935	17000-17377	NO	10K
	31	07936-08191	17400-17777	NO	
	32	08192-08447	20000-20377	YES	
	33	08448-08703	20400-20777	NO	
SCIENTIFIC INSTRUCTION SET	34	08704-08959	21000-21377	YES	11K
	35	08960-09215	21400-21777	YES	
	36	09216-09571	22000-22377	YES	
HP RESERVED	37	09572-09727	22400-22777	NO	12K
	38	09728-09983	23000-23377	YES	
	39	09984-10239	23400-23777	NO	
	40	10240-10495	24000-24377	YES	
RECOMMENDED FOR USER MICROPROGRAMMING	41	10496-10751	24400-24777	NO	13K
	42	10752-10917	25000-25377	NO	
	43	10918-11263	25400-25777	NO	
HP RESERVED	44	11264-11519	26000-26377	NO	14K
	45	11520-11775	26400-26777	NO	
	46	11776-12031	27000-27377	YES	
	47	12032-12287	27400-27777	YES	
HP RESERVED	48	12288-12543	30000-30377	YES	15K
	49	12544-12799	30400-30777	YES	
	50	12800-13055	31000-31377	YES	
RECOMMENDED FOR USER MICROPROGRAMMING	51	13056-13311	31400-31777	NO	16K
	52	13312-13557	32000-32377	NO	
	53	13558-13823	32400-32777	NO	
	54	13824-14079	33000-33377	NO	
HP RESERVED	55	14080-14335	33400-33777	NO	15K
	56	14336-14591	34000-34377	YES	
	57	14592-14847	34400-34777	YES	
HP RESERVED	58	14848-15103	35000-35377	YES	16K
	59	15104-15359	35400-35777	YES	
	60	15360-15615	36000-36377	YES	
HP RESERVED	61	15616-15871	36400-36777	NO	16K
	62	15872-16127	37000-37377	YES	
	63	16128-16383	37400-37777	NO	

Figure 11-3. F-Series Control Memory Map

HP 1000 E-SERIES BASE INSTRUCTION SET AND EIG/FLOATING POINT FIRMWARE

SECTION XII

12-1. INTRODUCTION

This section provides installation and reference information for the E-Series Base Set (BS) and Extended Instruction Group/Floating Point (EIG/FP) Firmware. Additional information is provided in the manuals listed in the Preface.

12-2. DESCRIPTION

The E-Series Base Set and EIG/Floating Point ROMs (BS and EIG/FP) consist of 3 read-only-memory (ROM) integrated-circuits (IC's).

Description	HP Part No.
8K ROM IC (bits 7-0)	02113-80006
8K ROM IC (bits 15-8)	02113-80007
8K ROM IC (bits 23-16)	02113-80008

12-3. INSTALLATION

The BS and EIG/FP ROMs can be installed on the CPU board or a Firmware Expansion Module (FEM). If a FEM is available, it is recommended that the ROMs be installed here to facilitate future service.

CPU BOARD

- Remove the CPU board as described in the appropriate Installation and Service Manual.
- The ROMs must be installed in the following locations.

Location	ROM IC	Bits	Module No.
U21	VACANT	—	—
U41	VACANT	—	—
U81	VACANT	—	—
U23	02113-80006	7-0	0, 1, 2, 3
U43	02113-80007	8-15	
U83	02113-80008	16-23	

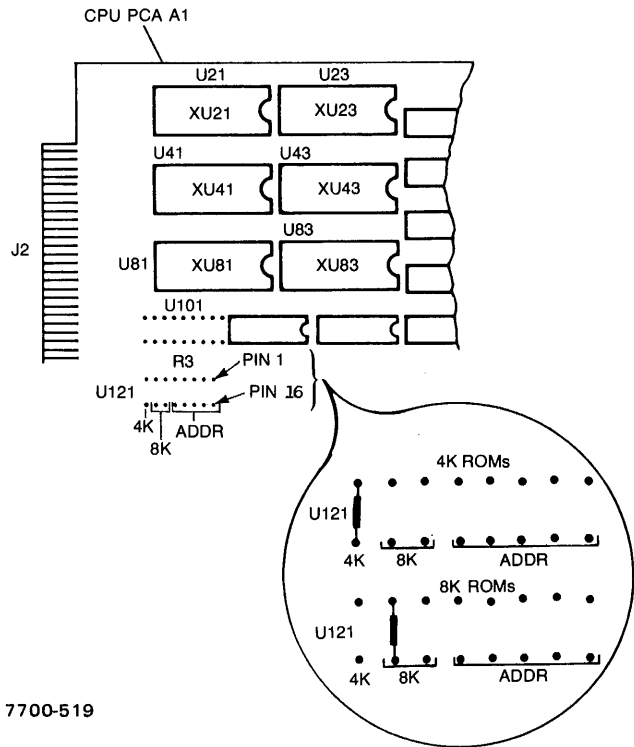

7700-519

- Configure the CPU board for operation with 8K ROMs.
- Only the 8K jumper nearest the 4K jumper must be in (pins 7 and 10 of IC location U121). All other jumpers must be out. The silk screen indicating a second 8K jumper (pins 6 and 11) is in error, and this jumper must be out.
- Install the CPU board as described in the appropriate Installation and Service Manual.
 - Perform the verification as described below.

FIRMWARE EXPANSION MODULE

- Refer to section II of this manual for the FEM removal procedure (if necessary).
- The ROMs can be installed in any available socket set on the FEM. For example, assume we are going to use SET A.

Location	ROM IC
A1	02113-80006
A2	02113-80007
A3	02113-80008

- c. Configure SWA for 8K ROMs modules 0, 1, 2, 3. Refer to figure 2-1 and table 2-1.

All unused socket sets must have switch S1 closed.

SWA

Switch	Setting
S1	1
S2	0
S3	1
S4	0
S5	1
S6	0
S7	0
S8	0
S9	0
S10	X (Don't care)

- d. Install the FEM board.
- e. Perform the verification as described below.

12-4. VERIFICATION

INSTALLATION

After installing the ROMs, verify proper installation by running the firmware self test.

The base set includes three tests that quickly test the computer and memory. These firmware self-tests are not designed as a substitute for more complex software diagnostics and it may frequently be the case that you require a more thorough and detailed testing than provided by these standard self-test routines.

Test 1 tests most of the computer registers and functions. This test will not alter or destroy the contents of any working register or memory. An error condition will set all display register indicator bits (A, B, M, T, P, S) and the overflow register. The execution time is negligible.

Test 2 is a fast microprogrammed memory test that checks the presently enabled memory space (up to 32k words). The microprogram reads each memory location, complements the data and writes it back, reads it, compares it to expected data, then complements it and writes it back into memory. The execution time is negligible and is non-destructive to memory data. An error condition is usually accompanied by a parity error indication and will set all display register indicator bits and clear the overflow register. The A-register will contain the expected (good) data, the B-register will contain the actual (bad) data, and the M-register will contain the logical memory location of the failure.

Test 3 is a significantly more sophisticated microprogrammed memory test. All memory installed in the computer will be tested. Execution time is dependent on

the amount of memory installed; approximately one second per 32k words. The display register will increment as each 32k words of memory are tested. Error reporting is the same as in Test 2 except the S-register will contain the number of the 32k words where the memory failure occurred.

On a cold power-up (as described below), Tests 1 and 3 will each be executed once. Pressing the IBL/TEST switch on the operator panel will not only perform the loader function, it will also cause the execution of Tests 1 and 2.

Executing the octal instruction 100000 via the INSTR STEP switch on the operator panel with the LOCK/OPERATE switch in the OPERATE position will execute Tests 1 and 3 once. The information contained in the S-register (when selected) will be the final background pattern used to test memory. This may also be used to easily load the entire memory with the same bit pattern. While the tests are executing, the LOCK/OPERATE switch may be set to the LOCK position and the microprogrammed self-tests will loop continuously until the LOCK/OPERATE switch is returned to the OPERATE position. A memory failure, of course, will terminate the test and report the error.

To check most computer registers and functions and all physical memory, perform the cold power-up procedure as follows:

- a. Set ~ POWER switch to OFF. If computer is equipped with an optional power fail recovery system, set BATTERY switch to OFF.
- b. Set the LOCK/OPERATE switch to OPERATE. Wait approximately six seconds and then set ~ POWER switch to ON.
- c. Set BATTERY switch to INT (if installed).
- d. The self-test will begin execution and the Display Register can be observed incrementing if a dynamic mapping system (DMS) is installed.
- e. Upon successful completion, the T-register will automatically be selected for display.
- f. If a computer failure is detected, the Display Register, all six working register indicators (A, B, M, T, P, S), and the OVERFLOW indicator are lighted. Refer to the appropriate Installation and Service manual for troubleshooting procedure.
- g. If a memory failure is detected, the Display Register, and all six working register indicators (A, B, M, T, P, S) are lighted and the OVERFLOW indicator is not lighted. To isolate the memory failure, refer to the appropriate Memory Systems Installation and Service Manual.

To execute tests 1 and 3 once from the operator panel:

- a. Store 100000 (octal) in the A-register.
- b. Store 0 in the P-register.
- c. Press PRESET.
- d. Press INSTR STEP.

Upon successful completion, the T-register will automatically be selected for display. A failure will result in the conditions indicated in steps f and g above.

OPERATION

To verify operation of the CPU and all Base Set instructions, refer to the Diagnostic Configurator Reference

Manual (part no. 02100-90157), Table A-1 or A-2, and run the appropriate instruction group diagnostic.

<u>Description</u>	<u>Manual</u>	<u>Absolute Binary No.</u>
Memory Reference Instruction Group	02100-90218	24315-16001
Alter Skip Instruction Group	02100-90211	24316-16001
Shift Rotate Instruction Group	02100-90212	24317-16001
EAU Instruction Group	02100-90214	24319-16001
Floating Point Instruction Group	24320-90001	24320-16001
I/O Instruction Group/I/O Extender	02100-90213	24318-16001
Extended Instruction Group (Index)	12943-90004	12943-16002
Extended Instruction Group (Word, Byte, Bit)	12943-90004	12943-16001

HP 1000 F-SERIES BASE INSTRUCTION SET AND EIG/FLOATING POINT FIRMWARE

SECTION XIII

13-1. INTRODUCTION

This section provides installation and reference information for the F-Series Base Set (BS) and Extended Instruction Group/Floating Point (EIG/FP) Firmware. Additional information is provided in the manuals listed in the Preface.

13-2. DESCRIPTION

The F-Series Base Set and EIG/Floating Point ROMs (BS and EIG/FP) consist of 3 read-only-memory (ROM) integrated circuits (IC's).

Description	HP Part No.
8K ROM IC (bits 7-0)	02117-80016
8K ROM IC (bits 15-8)	02117-80017
8K ROM IC (bits 23-16)	02117-80018

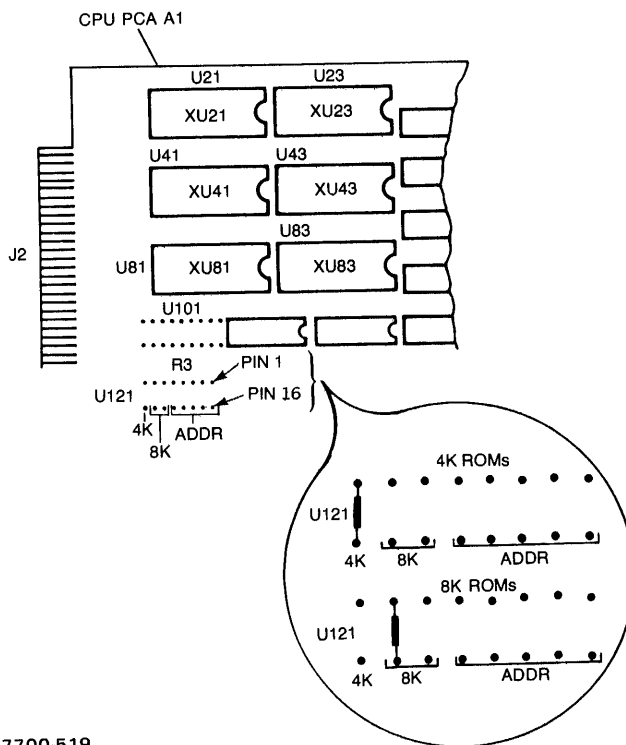

7700-519

13-3. INSTALLATION

The BS and EIG/FP ROMs can be installed on the CPU board or a Firmware Expansion Module (FEM). If a FEM is available, it is recommended that the ROMs be installed here to facilitate future service.

CPU BOARD

- Remove the CPU board as described in the appropriate Installation and Service Manual.
- The ROMs must be installed in the following locations.

Location	ROM IC	Bits	Module No.
U21	VACANT	—	—
U41	VACANT	—	—
U81	VACANT	—	—
U23	02117-80016	7-0	0, 1, 2, 3
U43	02117-80017	15-8	
U83	02117-80018	23-16	

- Configure the CPU board for operation with 8K ROMs.

Only the 8K jumper nearest the 4K jumper must be in (pins 6 and 9 of IC location U121). All other jumpers must be out. The silk screen indicating a second 8K jumper is in error.

- Install the CPU board as described in the appropriate Installation and Service Manual.
- Perform the verification as described below.

FIRMWARE EXPANSION MODULE

- Refer to section II of this manual for the FEM removal procedure (if necessary).
- The ROMs can be installed in any available socket set on the FEM. For example, assume we are going to use Set A.

Location	ROM IC
A1	02117-80016
A2	02117-80017
A3	02117-80018

- c. For 8K ROM configuration, configure SWA for modules 0, 1, 2, 3. Refer to figure 2-1 and table 2-1 for reference.

All unused socket sets must have switch S1 closed.

SWA

Switch	Setting
S1	1
S2	0
S3	1
S4	0
S5	1
S6	0
S7	0
S8	0
S9	0
S10	X (Don't care)

- d. Install the FEM board.
- e. Perform the verification as described below.

13-4. VERIFICATION

INSTALLATION

After installing the ROMs, verify proper installation by running the firmware self test.

CPU AND MEMORY. The base set includes three tests that quickly test the computer and memory. These firmware self-tests are not designed as a substitute for more complex software diagnostics and it may frequently be the case that you require a more thorough and detailed testing than provided by these standard self-test routines.

Test 1 tests most of the computer registers and functions. This test will not alter or destroy the contents of any working register or memory. An error condition will set all display register indicator bits (A, B, M, T, P, S) and the overflow register. The execution time is negligible.

Test 2 is a fast microprogrammed memory test that checks the presently enabled memory space (up to 32k words). The microprogram reads each memory location, complements the data and writes it back, reads it, compares it to expected data, then complements it and writes it back into memory. The execution time is negligible and is non-destructive to memory data. An error condition is usually accompanied by a parity error indication and will set all display register indicator bits and clear the overflow register. The A-register will contain the expected (good) data, the B-register will contain the actual (bad) data, and the M-register will contain the logical memory location of the failure.

Test 3 is a significantly more sophisticated microprogrammed memory test. All memory installed in the

computer will be tested. Execution time is dependent on the amount of memory installed; approximately one second per 32k words. The display register will increment as each 32k words of memory are tested. Error reporting is the same as in Test 2 except the S-register will contain the number of the 32k words where the memory failure occurred.

On a cold power-up (as described below), Tests 1 and 3 will each be executed once. Pressing the IBL/TEST switch on the operator panel will not only perform the loader function, it will also cause the execution of Tests 1 and 2.

Executing the octal instruction 100000 via the INSTR STEP switch on the operator panel with the LOCK/OPERATE switch in the OPERATE position will execute Tests 1 and 3 once. The information contained in the S-register (when selected) will be the final background pattern used to test memory. This may also be used to easily load the entire memory with the same bit pattern. While the tests are executing, the LOCK/OPERATE switch may be set to the LOCK position and the microprogrammed self-tests will loop continuously until the LOCK/OPERATE switch is returned to the OPERATE position. A memory failure, of course, will terminate the test and report the error.

To check most computer registers and functions and all physical memory, perform the cold power-up procedure as follows:

- a. Set ~ POWER switch to OFF. If computer is equipped with an optional power fail recovery system, set BATTERY switch to OFF.
- b. Set the LOCK/OPERATE switch to OPERATE. Wait approximately six seconds and then set ~ POWER switch to ON.
- c. Set BATTERY switch to INT (if installed).
- d. The self-test will begin execution and the Display Register can be observed incrementing if a dynamic mapping system (DMS) is installed.
- e. Upon successful completion, the T-register will automatically be selected for display.
- f. If a computer failure is detected, the Display Register, all six working register indicators (A, B, M, T, P, S), and the OVERFLOW indicator are lighted. Refer to the appropriate Installation and Service manual for troubleshooting procedure.
- g. If a memory failure is detected, the Display Register, and all six working register indicators (A, B, M, T, P, S) are lighted and the OVERFLOW indicator is not lighted. To isolate the memory failure, refer to the appropriate Memory Systems Installation and Service Manual.

To execute tests 1 and 3 once from the operator panel:

- a. Store 100000 (octal) in the A-register.
- b. Store 0 in the P-register.
- c. Press PRESET.
- d. Press INSTR STEP.

Upon successful completion, the T-register will automatically be selected for display. A failure will result in the conditions indicated in steps f and g above.

FLOATING POINT. The F-Series computer includes a firmware self-test for testing the floating point PCA's. This self-test detects obvious trouble symptoms but is not intended as a substitute for the more comprehensive software diagnostic. (The self-test can only be executed in the single-step front panel mode; if entered in the run-mode, a NOP is performed.) To execute the firmware self-test, proceed as follows:

- a. Store 105004 (octal) in the A-register.
- b. Store 0 in the P-register and press PRESET. If the OVFL light remains on, check that the FPP-MPP cable is installed correctly (not twisted). Otherwise, a defective CPU, floating point PCA, or FPP is indicated. Use software diagnostics for further troubleshooting.
- c. Press INSTR STEP.
- d. A 102077 (octal) in the display register (S) indicates successful completion. If 10200X (octal) is returned in the display register, the firmware test failed and the halt code is interpreted as shown in table 13-1. If the firmware test returns an error halt code, use software diagnostics for further troubleshooting.

Table 13-1. Floating Point Self-Test Error Halts

HALT	PROBABLE PROBLEM
102001	<ol style="list-style-type: none"> a. Power not supplied to floating-point PCA's. b. FPP-MPP cable not properly connected. Refer to Installation and Reference Manual. c. Floating point CONTROL PCA not installed or not connected properly. d. If A-register not 177777 (octal) and B-register not 0, then floating point ROMs defective.
102002	<ol style="list-style-type: none"> a. If A- and B-registers equal 0 and OVFL lit, then FPP-MPP cable twisted. b. If A- and B-registers equal 177777 (octal), then floating point ARITH PCA not connected properly or CPU-MPP cable not connected.
102003	<ol style="list-style-type: none"> a. Floating point PCA, ALU PCA, or cables defective.
102004	<ol style="list-style-type: none"> a. Floating point PCA, ALU PCA, or cables defective.
XXXXXX	<ol style="list-style-type: none"> a. If display register does not indicate any of the above halts, either the floating point ROMs are not present, ROMs are defective, or computer is defective.

OPERATION

To verify operation of the CPU and all Base Set Instructions, and HFPP, refer to the Diagnostic Configurator Reference Manual (part no. 02100-90157), Table A-1 or A-2, and run the appropriate instruction group diagnostic.

<u>Description</u>	<u>Manual</u>	<u>Absolute Binary No.</u>
Memory Reference Instruction Group	02100-90218	24315-16001
Alter Skip Instruction Group	02100-90211	24316-16001
Shift Rotate Instruction Group	02100-90212	24317-16001
EAU Instruction Group	02100-90214	24319-16001
I/O Instruction Group/I/O Extender	02100-90213	24318-16001
Extended Instruction Group (Index)	12943-90004	12943-16002
Extended Instruction Group (Word, Byte, Bit)	12943-90004	12943-16001
F-Series FPP/SIS/FFP	12740-90004	12740-16001

E-SERIES RTE-6/VM OPERATING SYSTEM/EMA/VMA FIRMWARE

SECTION

XIV

14-1. INTRODUCTION

This section provides installation and reference information for the HP RTE-6/VM Operating System/Extended Memory Area/Virtual Memory Area (OS/EMA/VMA) Firmware for the HP 1000 E-Series. See Section XV for similar information for an HP 1000 F-Series. Additional information is provided in the manuals listed in the Preface.

14-2. DESCRIPTION

The HP RTE-6/VM OS/VMA/EMA firmware consists of six 4K ROMs that are installed on the FEM board. The six ROMs are divided into two groups, a set of three 4K ROMs for the RTE-6/VM Operating System firmware allocated to control memory modules 44 and 45, and a set of three 4K ROMs for the RTE-6/VM EMA/VMA firmware allocated to control memory modules 36 and 37 as follows:

DESCRIPTION	HP PART NO.	CONTROL MEMORY MODULE NO.
4K ROM IC (bits 7-0)	92084-80001	44, 45
4K ROM IC (bits 15-8)	92084-80102	44, 45
4K ROM IC (bits 23-16)	92084-80103	44, 45
4K ROM IC (bits 7-0)	92084-80004	36, 37
4K ROM IC (bits 15-8)	92084-80005	36, 37
4K ROM IC (bits 23-16)	92084-80006	36, 37

14-3. INSTALLATION

The six RTE-6/VM OS/VMA/EMA ROMs can be installed on the HP 13304A Firmware Accessory Board (FAB) or the HP 12791A Firmware Expansion Module (FEM). If a FEM with an unused block of sockets is available, it may be desirable to install the ROMs on the FEM to facilitate future access to the ROMs.

NOTE

The RTE-IV EMA firmware is allocated to the same Control Store modules as the RTE-6/VM EMA/VMA firmware. Therefore, RTE-6/VM EMA/VMA and RTE-IV EMA firmware must not both be installed in the same computer.

14-4. FIRMWARE ACCESSORY BOARD

- Install the six ROM ICs in the following locations on the FAB (see figure 1-2):

LOCATION	ROM IC	BITS	MODULE NO.
D1 (XU101)	92084-80001	7-0	44, 45
D2 (XU102)	92084-80102	15-8	44, 45
D3 (XU103)	92084-80003	23-16	44, 45
C1 (XU201)	92084-80004	7-0	36, 37
C2 (XU202)	92084-80005	15-8	36, 37
C3 (XU203)	92084-80006	23-16	36, 37

NOTE

If DS/1000 ROMs 91740-80064, 91740-80065, and 91740-80066 are located on the FAB board, they must be located in sockets C4, C5, and C6 respectively.

- Set jumpers on FAB as follows:

JUMPER	SETTING
10C	1
11C	0
12C	0
13C	1
10D	1
11D	1
12D	0
13D	1

- Refer to Section I for the FAB installation procedure.
- Perform verification as described below in Section 14-5.

14-5. FIRMWARE EXPANSION MODULE

- Refer to section II of this manual for the FEM removal and installation procedure.
- Install the six ROM ICs in any available set of sockets and configure the switches as shown in table 2-1 for Control Memory modules 36, 37, 44, and 45.
- Refer to section II for the FEM installation procedure.
- Perform verification as described below.

14-6. VERIFICATION

After reinstalling the computer in your system, verify correct RTE-6/VM OS/EMA/VMA Firmware installation by running the two RTE-6/VM Firmware Self-Tests. Both Self-Tests check for correct IC orientation and firmware addressing — one checks the RTE-6/VM OS firmware and the other checks the RTE-6/VM EMA/VMA firmware. To execute the RTE-6/VM OS Firmware Self-Test proceed as follows:

- a. Store 105355B in the A-Register.
- b. Store 0 in the P-Register.
- c. Press PRESET.
- d. Press INSTR STEP.

If the Self-Test passes, a 102077B will appear in the S-Register. The contents of the x-Register will indicate the revision of the installed firmware. Any other value displayed in the S-Register indicates the RTE-6/VM OS Firmware Self-Test failed. Refer to the Service Information paragraph of the FEM section of this manual (section II) for troubleshooting procedure.

To execute the RTE-6/VM EMA/VMA Firmware Self-Test proceed as follows:

- a. Store 105242B in the A-Register.
- b. Store 0 in the P-Register.
- c. Press PRESET.
- d. Press INSTR STEP.

If the Self-Test passes, a 102077B will appear in the S-Register. The contents of the x-Register indicate the revision of the installed firmware. Any other value displayed in the S-Register indicates the RTE-6/VM VMA/EMA Firmware Self-Test failed. Refer to the Service Information paragraph of the FEM section of this manual (section II) for troubleshooting procedure.

F-SERIES RTE-6/VM OPERATING SYSTEM/EMA/VMA FIRMWARE

SECTION

XV

15-1. INTRODUCTION

This section provides installation and reference information for the HP RTE-6/VM Operating System/Extended Memory Area/Virtual Memory Area (OS/EMA/VMA) Firmware for the HP 1000 F-Series. See section XIV for similar information for an HP 1000 E-Series. Additional information is provided in the manuals listed in the Preface.

15-2. DESCRIPTION

The HP RTE-6/VM OS/VMA/EMA firmware consists of six 4K ROMs that are installed on the FEM board. The six ROMs are divided into two groups, a set of three 4K ROMs for the RTE-6/VM Operating System firmware allocated to control memory modules 16 and 17, and a set of three 4K ROMs for the RTE-6/VM EMA/VMA firmware allocated to control memory modules 36 and 37 as follows:

DESCRIPTION	HP PART NO.	CONTROL MEMORY MODULE NO.
4K ROM IC (bits 7-0)	92084-80001	16, 17
4K ROM IC (bits 15-8)	92084-80102	16, 17
4K ROM IC (bits 23-16)	92084-80103	16, 17
4K ROM IC (bits 7-0)	92084-80004	36, 37
4K ROM IC (bits 15-8)	92084-80005	36, 37
4K ROM IC (bits 23-16)	92084-80006	36, 37

15-3. INSTALLATION

The RTE-6/VM OS/EMA/VMA ROMs are installed on the 12791A Firmware Expansion Module (FEM). To install or remove the six RTE-6/VM ROMs, proceed as follows.

- Refer to section II of this manual for the FEM removal and installation procedure.
- Install the six ROM ICs in any available set of sockets and configure the switches as shown in table 2-1 for Control Memory modules 36, 37, 16, and 17.
- Refer to section II for the FEM installation procedure.
- Perform verification as described below.

NOTE

The RTE-IV EMA firmware is allocated to the same Control Store modules as the RTE-6/VM EMA/VMA firmware. Therefore, the RTE-6/VM EMA/VMA and the RTE-IV firmware must not both be installed in the same computer.

15-4. VERIFICATION

After reinstalling the computer in your system, verify correct RTE-6/VM OS/EMA/VMA Firmware installation by running the two RTE-6/VM Firmware Self-Tests. Both Self-Tests check for correct IC orientation and firmware addressing — one checks the RTE-6/VM OS firmware and the other checks the RTE-6/VM EMA/VMA firmware. To execute the RTE-6/VM OS Firmware Self-Test proceed as follows:

- Store 105355B in the A-Register.
- Store 0 in the P-Register.
- Press PRESET.
- Press INSTR STEP.

If the Self-Test passes, a 102077B will appear in the S-Register. The contents of the x-Register will indicate the revision of the installed firmware. Any other value displayed in the S-Register indicates the RTE-6/VM OS firmware self-test failed. Refer to the Service Information paragraph of the FEM section of this manual (section II) for troubleshooting procedure.

To execute the RTE-6/VM EMA/VMA Firmware Self-Test proceed as follows:

- Store 105242B in the A-Register.
- Store 0 in the P-Register.
- Press PRESET.
- Press INSTR STEP.

If the Self-Test passes, a 102077B will appear in the S-Register. The contents of the x-Register will indicate the current revision of the installed firmware. Any other value displayed in the S-Register indicates the RTE-6/VM EMA/VMA Firmware Self-Test failed. Refer to the Service Information paragraph of the FEM section of this manual (section II) for troubleshooting procedure.

HP 12823F F-SERIES ENHANCEMENT UPGRADE KIT

APPENDIX

A

A-1. DESCRIPTION

The HP 12823F F-Series Enhancement Upgrade Kit allows the customer to upgrade a F-Series Computer (2111F or 2117F) which was shipped with a serial prefix less than 1920 with the enhanced Base Set, enhanced FFP, and enhanced SIS ROMs. The 12823F product consists of the eighteen read-only-memory (ROM) integrated circuits (ICs) which are listed under the designation "New Part No." below.

BASE INSTRUCTION SET

<u>Description</u>	<u>New Part No.</u>	<u>Location</u>
8K ROM IC (bits 7-0)	02117-80016	A1U23
8K ROM IC (bits 15-8)	02117-80017	A1U43
8K ROM IC (bits 23-16)	02117-80018	A1U83
	VACANT	A1U21
	VACANT	A1U41
	VACANT	A1U81

SCIENTIFIC INSTRUCTION SET (SIS)

<u>Description</u>	<u>New Part No.</u>
8K ROM IC (bits 7-0)	5180-0141
8K ROM IC (bits 15-8)	5180-0142
8K ROM IC (bits 23-16)	5180-0143

FAST FORTRAN PROCESSOR (FFP)

<u>Description</u>	<u>New Part No.</u>
8K ROM IC (bits 7-0)	12823-80019
8K ROM IC (bits 15-8)	12823-80020
8K ROM IC (bits 23-16)	12823-80021

A-2. INSTALLATION

- For installation of the Base Instruction Set, refer to section XIII of this manual.
- For installation of the Scientific Instruction Set ROMs, refer to section VIII of this manual.
- For installation of the Fast FORTRAN Processor ROMs, refer to section VII of this manual.
- Perform the appropriate self-test and diagnostic to verify installation and functional operation of the firmware.

SALES & SUPPORT OFFICES

Arranged alphabetically by country

1



Product Line Sales/Support Key

Key Product Line

- A Analytical
- CM Components
- C Computer Systems Sales only
- CH Computer Systems Hardware Sales and Services
- CS Computer Systems Software Sales and Services
- E Electronic Instruments & Measurement Systems
- M Medical Products
- MP Medical Products Primary SRO
- MS Medical Products Secondary SRO
- P Personal Computation Products
- Sales only for specific product line
- .. Support only for specific product line

IMPORTANT: These symbols designate general product line capability. They do not insure sales or support availability for all products within a line, at all locations. Contact your local sales office for information regarding locations where HP support is available for specific products.

HP distributors are printed in italics.

HEADQUARTERS OFFICES

If there is no sales office listed for your area, contact one of these headquarters offices.

NORTH/CENTRAL AFRICA

Hewlett-Packard S.A.
7, Rue du Bois-du-Lan
CH-1217 MEYRIN 2, Switzerland
Tel: (022) 83 12 12
Telex: 27835 hpse
Cable: HEWPACKSA Geneve

ASIA

Hewlett-Packard Asia Ltd.
6th Floor, Sun Hung Kai Centre
30 Harbour Rd.
G.P.O. Box 795
HONG KONG
Tel: 5-832 3211
After Jan. 1, 1984
47th Floor, China Resources Bldg.
26 Harbour Rd., Wanchai
HONG KONG
Tel: 66678 HEWPA HX
Cable: HEWPACK HONG KONG

CANADA

Hewlett-Packard (Canada) Ltd.
6877 Goreway Drive
MISSISSAUGA, Ontario L4V 1M8
Tel: (416) 678-9430
Telex: 610-492-4246

EASTERN EUROPE

Hewlett-Packard Ges.m.b.h.
Liebigasse 1
P.O.Box 72
A-1222 VIENNA, Austria
Tel: (222) 2365 110
Telex: 1 3 4425 HEPA A

NORTHERN EUROPE

Hewlett-Packard S.A.
Uilenstede 475
P.O.Box 999
NL-1180 AZ AMSTELVEEN
The Netherlands
Tel: 20 437771

SOUTH EAST EUROPE

Hewlett-Packard S.A.
7, Rue du Bois-du-Lan
CH-1217 MEYRIN 2, Switzerland
Tel: (022) 83 12 12
Telex: 27835 hpse
Cable: HEWPACKSA Geneve

OTHER EUROPE

Hewlett-Packard S.A.
P.O. Box
150, Rte du Nant-D'Avril
CH-1217 MEYRIN 2, Switzerland
Tel: (022) 83 8111
Telex: 22486 hpsa
Cable: HEWPACKSA Geneve

MEDITERRANEAN AND MIDDLE EAST

Hewlett-Packard S.A.
Mediterranean and Middle East
Operations
Atrina Centre
32 Kifissias Ave.
Paradissos-Amarousion, ATHENS
Greece
Tel: 682 88 11
Telex: 21-6588 HPAT GR
Cable: HEWPACKSA Athens

EASTERN USA

Hewlett-Packard Co.
4 Choke Cherry Road
ROCKVILLE, MD 20850
Tel: (301) 258-2000

MIDWESTERN USA

Hewlett-Packard Co.
5201 Tolview Drive
ROLLING MEADOWS, IL 60008
Tel: (312) 255-9800

SOUTHERN USA

Hewlett-Packard Co.
2000 South Park Place
P.O. Box 105005
ATLANTA, GA 30348
Tel: (404) 955-1500

WESTERN USA

Hewlett-Packard Co.
3939 Lankershim Blvd.
P.O. Box 3919
LOS ANGELES, CA 91604
Tel: (213) 506-3700

OTHER INTERNATIONAL AREAS

Hewlett-Packard Co.
Intercontinental Headquarters
3495 Deer Creek Road
PALO ALTO, CA 94304
Tel: (415) 857-1501
Telex: 034-8300
Cable: HEWPACK

ANGOLA

Telectra
Empresa Técnica de Equipamentos
R. Barbosa Rodrigues, 41-I DT.
Caixa Postal 6487
LUANDA
Tel: 355 15,355 16
E,P

ARGENTINA

Hewlett-Packard Argentina S.A.
Avenida Santa Fe 2035
Martinez 1640 BUENOS AIRES
Tel: 798-5735, 792-1293
Telex: 17595 BIONAR
Cable: HEWPACKARG
A,E,CH,CS,P
Biotron S.A.C.I.M. e I.
Av Paseo Colon 221, Piso 9
1399 BUENOS AIRES
Tel: 30-4846, 30-1851
Telex: 17595 BIONAR
M

AUSTRALIA

Adelaide, South Australia Office

Hewlett-Packard Australia Ltd.
153 Greenhill Road
PARKSIDE, S.A. 5063
Tel: 272-5911
Telex: 82536
Cable: HEWPARAD Adelaide
A*,CH,CM,,E,MS,P

Brisbane, Queensland Office

Hewlett-Packard Australia Ltd.
10 Payne Road
THE GAP, Queensland 4061
Tel: 30-4133
Telex: 42133
Cable: HEWPARAD Brisbane
A,CH,CM,E,M,P

Canberra, Australia Capital Territory Office

Hewlett-Packard Australia Ltd.
121 Wollongong Street
FYSHWICK, A.C.T. 2609
Tel: 80 4244
Telex: 62650
Cable: HEWPARAD Canberra
CH,CM,E,P

Melbourne, Victoria Office

Hewlett-Packard Australia Ltd.
31-41 Joseph Street
BLACKBURN, Victoria 3130
Tel: 895-2895
Telex: 31-024
Cable: HEWPARAD Melbourne
A,CH,CM,CS,E,MS,P

Perth, Western Australia Office

Hewlett-Packard Australia Ltd.
261 Stirling Highway
CLAREMONT, W.A. 6010
Tel: 383-2188
Telex: 93859
Cable: HEWPARAD Perth
A,CH,CM,E,MS,P

Sydney, New South Wales Office

Hewlett-Packard Australia Ltd.
17-23 Talavera Road
P.O. Box 308
NORTH RYDE, N.S.W. 2113
Tel: 887-1611
Telex: 21561
Cable: HEWPARAD Sydney
A,CH,CM,CS,E,MS,P

AUSTRIA

Hewlett-Packard Ges.m.b.h.
Grottenhofstrasse 94
A-8052 GRAZ
Tel: (0316) 291 5 66
Telex: 32375
CH,E
Hewlett-Packard Ges.m.b.h.
Liebigasse 1
P.O. Box 72
A-1222 VIENNA
Tel: (0222) 23 65 11-0
Telex: 134425 HEPA A
A,CH,CM,CS,E,MS,P

BAHRAIN

Green Salon
P.O. Box 557
Manama
BAHRAIN
Tel: 255503-255950
Telex: 844 19
P

Wael Pharmacy

P.O. Box 648
BAHRAIN
Tel: 256 123
Telex: 8550 WAEL BN
E,C,M

BELGIUM

Hewlett-Packard Belgium S.A./N.V.
Blvd de la Woluwe, 100
Woluwedal
B-1200 BRUSSELS
Tel: (02) 762-32-00
Telex: 23-494 paloben bru
A,CH,CM,CS,E,MP,P

BRAZIL

Hewlett-Packard do Brasil I.e.C. Ltda.
Alameda Rio Negro, 750
Alphaville
06400 BARUERI SP
Tel: (011) 421.1311
Telex: (011) 33872 HPBR-BR
Cable: HEWPACK Sao Paulo
A,CH,CM,CS,E,M,P
Hewlett-Packard do Brasil I.e.C. Ltda.
Avenida Epitacio Pessoa, 4664
22471 RIO DE JANEIRO-RJ
Tel: (021) 286.0237
Telex: 021-21905 HPBR-BR
Cable: HEWPACK Rio de Janeiro
A,CH,CM,E,MS,P*
ANAMED I.C.E.I. Ltda.
Rua Bage, 103
04012 SAO PAULO
Tel: (011) 570-5726
Telex: 021-21905 HPBR-BR
M



SALES & SUPPORT OFFICES

Arranged alphabetically by country

CANADA

Alberta

Hewlett-Packard (Canada) Ltd.
3030 3rd Avenue N.E.
CALGARY, Alberta T2A 6T7
Tel: (403) 235-3100
A,CH,CM,E*,MS,P*

Hewlett-Packard (Canada) Ltd.
11120A-178th Street
EDMONTON, Alberta T5S 1P2
Tel: (403) 486-6666
A,CH,CM,CS,E,MS,P

British Columbia

Hewlett-Packard (Canada) Ltd.
10691 Shelbridge Way
RICHMOND,
British Columbia V6X 2W7
Tel: (604) 270-2277
Telex: 610-922-5059
A,CH,CM,CS,E*,MS,P*

Manitoba

Hewlett-Packard (Canada) Ltd.
380-550 Century Street
WINNIPEG, Manitoba R3H 0Y1
Tel: (204) 786-6701
A,CH,CM,E,MS,P*

Nova Scotia

Hewlett-Packard (Canada) Ltd.
P.O. Box 931
900 Windmill Road
DARTMOUTH, Nova Scotia B2Y 3Z6
Tel: (902) 469-7820
CH,CM,CS,E*,MS,P*

Ontario

Hewlett-Packard (Canada) Ltd.
3325 N. Service Rd., Unit 6
BURLINGTON, Ontario P3A 2A3
Tel: (416) 335-8644
CS,M*

Hewlett-Packard (Canada) Ltd.
552 Newbold Street
LONDON, Ontario N6E 2S5
Tel: (519) 686-9181
A,CH,CM,E*,MS,P*

Hewlett-Packard (Canada) Ltd.
6877 Goreway Drive
MISSISSAUGA, Ontario L4V 1M8
Tel: (416) 678-9430
A,CH,CM,CS,E,MP,P

Hewlett-Packard (Canada) Ltd.
2670 Queensview Dr.
OTTAWA, Ontario K2B 8K1
Tel: (613) 820-6483
A,CH,CM,CS,E*,MS,P*

Hewlett-Packard (Canada) Ltd.
220 Yorkland Blvd., Unit #11
WILLOWDALE, Ontario M2J 1R5
Tel: (416) 499-9333
CH

Quebec

Hewlett-Packard (Canada) Ltd.
17500 South Service Road
Trans-Canada Highway
KIRKLAND, Quebec H9J 2M5
Tel: (514) 697-4232
A,CH,CM,CS,E,MP,P*

Hewlett-Packard (Canada) Ltd.
Les Galeries du Vallon
2323 Du Versant Nord
STE. FOY, Quebec G1N 4C2
Tel: (418) 687-4570
CH

CHILE

Jorge Calcagni y Cia. Ltda.
Av. Italia 634 Santiago
Casilla 16475
SANTIAGO 9
Tel: 222-0222
Telex: Public Booth 440001
A,CM,E,M

Olympia (Chile) Ltda.
Av. Rodrigo de Araya 1045
Casilla 256-V
SANTIAGO 21
Tel: (02) 22 55 044
Telex: 240-565 OLYMP CL
Cable: Olympiachile Santiagochile
CH,CS,P

CHINA, People's Republic of

China Hewlett-Packard Rep. Office
P.O. Box 418
1A Lane 2, Luchang St.
Beiwei Rd., Xuanwu District
BEIJING
Tel: 33-1947, 33-7426
Telex: 22601 CTSHP CN
Cable: 1920
A,CH,CM,CS,E,P

COLOMBIA

Instrumentación
H. A. Langebaek & Kier S.A.
Carrera 4A No. 52A-26
Apartado Aereo 6287
BOGOTA 1, D.E.
Tel: 212-1466
Telex: 44400 INST CO
Cable: AARIS Bogota
CM,E,M

Casa Humboldt Ltda.
Carrera 14, No. 98-60
Apartado Aereo 51283
BOGOTA 1, D.E.
Tel: 256-1686
Telex: 45403 CCAL CO.
A

COSTA RICA

Científica Costarricense S.A.
Avenida 2, Calle 5
San Pedro de Montes de Oca
Apartado 10159
SAN JOSE
Tel: 24-38-20, 24-08-19
Telex: 2367 GALGUR CR
CM,E,M

CYPRUS

Telexa Ltd.
P.O. Box 4809
14C Stassinou Avenue
NICOSIA
Tel: 62698
Telex: 2894 LEVIDO CY
E,M,P

DENMARK

Hewlett-Packard A/S
Datavej 52
DK-3460 **BIRKEROD**
Tel: (02) 81-66-40
Telex: 37409 hpas dk
A,CH,CM,CS,E,MS,P
Hewlett-Packard A/S
Rolighedsvej 32
DK-8240 **RISSKOV**, Aarhus
Tel: (06) 17-60-00
Telex: 37409 hpas dk
CH,E

DOMINICAN REPUBLIC

Microprog S.A.
Juan Tomás Mejía y Cotes No. 60
Arroyo Hondo
SANTO DOMINGO
Tel: 565-6268
Telex: 4510 ARENTA DR (RCA) P

ECUADOR

CYEDE Cia. Ltda.
Avenida Eloy Alfaro 1749
Casilla 6423 CCI
QUITO
Tel: 450-975, 243-052
Telex: 2548 CYEDE ED
CM,E,P

Hospitalar S.A.

Robles 625
Casilla 3590
QUITO
Tel: 545-250, 545-122
Telex: 2485 HOSP TL ED
Cable: HOSPITALAR-Quito
M

EGYPT

International Engineering Associates
24 Hussein Hegazi Street
Kastr-el-Aini
CAIRO
Tel: 23829, 21641
Telex: IEA UN 93830
CH,CS,E,M
EGYPTOR
P.O. Box 2558
42 El Zahraa Street
CAIRO, Egypt
Tel: 65 00 21
Telex: 93 337
P

EL SALVADOR

IPESA de El Salvador S.A.
29 Avenida Norte 1216
SAN SALVADOR
Tel: 26-6858, 26-6868
Telex: 20539 IPESASAL
A,CH,CM,CS,E,P

FINLAND

Hewlett-Packard Oy
Revontulentie 7
PL 24
SF-02101 **ESPOO 10**
Tel: (90) 4550211
Telex: 121563 hewpa sf
CH,CM,CS,P
Hewlett-Packard Oy
(Olarinluoma 7)
PL 24
02101 **ESPOO 10**
Tel: (90) 4521022
A,E,MS
Hewlett-Packard Oy
Aatoksenkatv 10-C
SF-40720-72 **JYVASKYLA**
Tel: (941) 216318
CH
Hewlett-Packard Oy
Kainvuntie 1-C
SF-90140-14 **OULU**
Tel: (981) 338785
CH

FRANCE

Hewlett-Packard France
Z.I. Mercure B
Rue Berthelot
F-13763 Les Milles Cedex
AIX-EN-PROVENCE
Tel: 16 (42) 59-41-02
Telex: 410770F
A,CH,E,MS,P*

Hewlett-Packard France
64, rue Marchand Saillant
F-61000 **ALENCON**
Tel: 16 (33) 29 04 42

Hewlett-Packard France
Boite Postale 503
F-25026 **BESANCON**
28 rue de la Republique
F-25000 **BESANCON**
Tel: 16 (81) 83-16-22
CH,M

Hewlett-Packard France
13, Place Napoleon III
F-29000 **BREST**
Tel: 16 (98) 03-38-35

Hewlett-Packard France
Chemin des Mouilles
Boite Postale 162
F-69130 **ECULLY** Cedex (Lyon)
Tel: 16 (78) 833-81-25
Telex: 310617F
A,CH,CS,E,MP

Hewlett-Packard France
Tour Lorraine
Boulevard de France
F-91035 **EVRY** Cedex
Tel: 16 6 077-96-60
Telex: 692315F
E

Hewlett-Packard France
Parc d'Activite du Bois Briard
Ave. du Lac
F-91040 **EVRY** Cedex
Tel: 16 6 077-8383
Telex: 692315F
E

Hewlett-Packard France
5, avenue Raymond Chanas
F-38320 **EYBENS** (Grenoble)
Tel: 16 (76) 25-81-41
Telex: 980124 HP GRENOB EYBE
CH

Hewlett-Packard France
Centre d'Affaire Paris-Nord
Bâtiment Ampère 5 étage
Rue de la Commune de Paris
Boite Postale 300
F-93153 **LE BLANC MESNIL**
Tel: 16 (1) 865-44-52
Telex: 211032F
CH,CS,E,MS

Hewlett-Packard France
Parc d'Activités Cadera
Quartier Jean Mermoz
Avenue du Président JF Kennedy
F-33700 **MERIGNAC** (Bordeaux)
Tel: 16 (56) 34-00-84
Telex: 550105F
CH,E,MS

Hewlett-Packard France
Immueble "Les 3 B"
Nouveau Chemin de la Garde
ZAC de Bois Briard
F-44085 **NANTES** Cedex
Tel: 16 (40) 50-32-22
CH**

**FRANCE (Cont'd)**

Hewlett-Packard France
125, rue du Faubourg Bannier
F-45000 ORLEANS
Tel: 16 (38) 68 01 63

Hewlett-Packard France
Zone Industrielle de Courtaboeuf
Avenue des Tropiques
F-91947 Les Ulis Cedex ORSAY
Tel: (6) 907-78-25
Telex: 600048F
A,CH,CM,CS,E,MP,P

Hewlett-Packard France
Paris Porte-Maillot
15, Avenue de L'Amiral Bruix
F-75782 PARIS CEDEX 16
Tel: 16 (1) 502-12-20
Telex: 613663F
CH,MS,P

Hewlett-Packard France
124, Boulevard Tourasse
F-64000 PAU
Tel: 16 (59) 80 38 02

Hewlett-Packard France
2 Allée de la Bourgonnette
F-35100 RENNES
Tel: 16 (99) 51-42-44
Telex: 740912F
CH,CM,E,MS,P*

Hewlett-Packard France
98 Avenue de Bretagne
F-76100 ROUEN
Tel: 16 (35) 63-57-66
CH* *,CS

Hewlett-Packard France
4 Rue Thomas Mann
Boite Postale 56
F-67033 STRASBOURG Cedex
Tel: 16 (88) 28-56-46
Telex: 890141F
CH,E,MS,P*

Hewlett-Packard France
Le Péripole
20, Chemin du Pigeonnier de la
Cépière
F-31083 TOULOUSE Cedex
Tel: 16 (61) 40-11-12
Telex: 531639F
A,CH,CS,E,P*

Hewlett-Packard France
9, rue Baudin
F-26000 VALENCE
Tel: 16 (75) 42 76 16

Hewlett-Packard France
Carolor
ZAC de Bois Briand
F-57640 VIGY (Metz)
Tel: 16 (8) 771 20 22
CH

Hewlett-Packard France
Immeuble Péricentre
F-59658 VILLENEUVE D'ASCQ Cedex
Tel: 16 (20) 91-41-25
Telex: 160124F
CH,E,MS,P*

**GERMAN FEDERAL
REPUBLIC**

Hewlett-Packard GmbH
Geschäftsstelle
Keithstrasse 2-4
D-1000 BERLIN 30
Tel: (030) 24-90-86
Telex: 018 3405 hpbln d
A,CH,E,M,P

Hewlett-Packard GmbH
Geschäftsstelle
Herrenberger Strasse 130
D-7030 BOBLINGEN
Tel: (7031) 14-0
Telex:
A,CH,CM,CS,E,MP,P

Hewlett-Packard GmbH
Geschäftsstelle
Emanuel-Leutze-Strasse 1
D-4000 DUSSELDORF
Tel: (0211) 5971-1
Telex: 085/86 533 hpdd d
A,CH,CS,E,MS,P

Hewlett-Packard GmbH
Geschäftsstelle
Schleefstr. 28a
D-4600 DORTMUND-Aplerbeck
Tel: (0231) 45001

Hewlett-Packard GmbH
Vertriebszentrale Frankfurt
Berner Strasse 117
Postfach 560 140
D-6000 FRANKFURT 56
Tel: (0611) 50-04-1
Telex: 04 13249 hpffm d
A,CH,CM,CS,E,MP,P

Hewlett-Packard GmbH
Geschäftsstelle
Aussenstelle Bad Homburg
Louisenstrasse 115
D-6380 BAD HOMBURG
Tel: (06172) 109-0

Hewlett-Packard GmbH
Geschäftsstelle
Kapstadtring 5
D-2000 HAMBURG 60
Tel: (040) 63804-1
Telex: 021 63 032 hphh d
A,CH,CS,E,MS,P

Hewlett-Packard GmbH
Geschäftsstelle
Heidering 37-39
D-3000 HANNOVER 61
Tel: (0511) 5706-0
Telex: 092 3259
A,CH,CM,E,MS,P

Hewlett-Packard GmbH
Geschäftsstelle
Rosslauer Weg 2-4
D-6800 MANNHEIM
Tel: (0621) 70050
Telex: 0462105
A,C,E

Hewlett-Packard GmbH
Geschäftsstelle
Messerschmittstrasse 7
D-7910 NEU ULM
Tel: 0731-70241
Telex: 0712816 HP ULM-D
A,C,E*

Hewlett-Packard GmbH
Geschäftsstelle
Ehhericherstr. 13
D-8500 NÜRNBERG 10
Tel: (0911) 5205-0
Telex: 0623 860
CH,CM,E,MS,P

Hewlett-Packard GmbH
Geschäftsstelle
Eschenstrasse 5
D-8028 TAUFKIRCHEN
Tel: (089) 6117-1
Telex: 0524985
A,CH,CM,E,MS,P

GREAT BRITAIN**See United Kingdom****GREECE**

Kostas Karaynnis S.A.
8 Omirou Street
ATHENS 133
Tel: 32 30 303, 32 37 371
Telex: 215962 RKAR GR
A,CH,CM,CS,E,M,P

PLAISIO S.A.
G. Gerardos
24 Stournara Street
ATHENS
Tel: 36-11-160
Telex: 221871
P

GUATEMALA

IPESA
Avenida Reforma 3-48, Zona 9
GUATEMALA CITY
Tel: 316627, 314786
Telex: 4192 TELTRO GU
A,CH,CM,CS,E,M,P

HONG KONG

Hewlett-Packard Hong Kong, Ltd.
G.P.O. Box 795
5th Floor, Sun Hung Kai Centre
30 Harbour Road
HONG KONG
Tel: 5-8323211
Telex: 66678 HEWPA HX
Cable: HEWPACK HONG KONG
E,CH,CS,P

CET Ltd.
1402 Tung Wah Mansion
199-203 Hennessy Rd.
Wanchia, HONG KONG
Tel: 5-729376
Telex: 85148 CET HX
CM

Schmidt & Co. (Hong Kong) Ltd.
Wing On Centre, 28th Floor
Connaught Road, C.
HONG KONG
Tel: 5-455644
Telex: 74766 SCHMX HX
A,M

ICELAND

Elding Trading Company Inc.
Hafnarnvoli-Tryggvagolou
P.O. Box 895
IS-REYKJAVIK
Tel: 1-58-20, 1-63-03
M

INDIA

Computer products are sold through
Blue Star Ltd. All computer repairs and
maintenance service is done through
Computer Maintenance Corp.

Blue Star Ltd.
Sabri Complex II Floor
24 Residency Rd.
BANGALORE 560 025
Tel: 55660
Telex: 0845-430
Cable: BLUESTAR
A,CH*,CM,CS*,E

Blue Star Ltd.
Band Box House
Prabhadevi
BOMBAY 400 025
Tel: 422-3101
Telex: 011-3751
Cable: BLUESTAR
A,M

Blue Star Ltd.
Sahas
414/2 Vir Savarkar Marg
Prabhadevi
BOMBAY 400 025
Tel: 422-6155
Telex: 011-4093
Cable: FROSTBLUE
A,CH*,CM,CS*,E,M

Blue Star Ltd.
Kalyan, 19 Vishwas Colony
Alkapuri, BORODA, 390 005
Tel: 65235
Cable: BLUE STAR
A

Blue Star Ltd.
7 Hare Street
CALCUTTA 700 001
Tel: 12-01-31
Telex: 021-7655
Cable: BLUESTAR
A,M

Blue Star Ltd.
133 Kodambakkam High Road
MADRAS 600 034
Tel: 82057
Telex: 041-379
Cable: BLUESTAR
A,M

Blue Star Ltd.
Bhandari House, 7th/8th Floors
91 Nehru Place
NEW DELHI 110 024
Tel: 682547
Telex: 031-2463
Cable: BLUESTAR
A,CH*,CM,CS*,E,M

Blue Star Ltd.
15/16:C Wellesley Rd.
PUNE 411 011
Tel: 22775
Cable: BLUE STAR
A

Blue Star Ltd.
2-2-47/1108 Bolarum Rd.
SECUNDERABAD 500 003
Tel: 72057
Telex: 0155-459
Cable: BLUEFROST
A,E

Blue Star Ltd.
T.C. 7/603 Poornima
Maruthankuzhi
TRIVANDRUM 695 013
Tel: 65799
Telex: 0884-259
Cable: BLUESTAR
E
Computer Maintenance Corporation
Ltd.
115, Sarojini Devi Road
SECUNDERABAD 500 003
Tel: 310-184, 345-774
Telex: 031-2960
CH**



SALES & SUPPORT OFFICES

Arranged alphabetically by country

INDONESIA

BERCA Indonesia P.T.
P.O.Box 496/Jkt.
Jl. Abdul Muis 62
JAKARTA
Tel: 21-373009
Telex: 46748 BERSAL IA
Cable: BERSAL JAKARTA P

BERCA Indonesia P.T.
P.O.Box 2497/Jkt
Antara Bldg., 17th Floor
Jl. Medan Merdeka Selatan 17
JAKARTA-PUSAT
Tel: 21-344-181
Telex: BERSAL IA
A,CS,E,M

BERCA Indonesia P.T.
P.O. Box 174/SBY.
Jl. Kutei No. 11
SURABAYA
Tel: 68172
Telex: 31146 BERSAL SB
Cable: BERSAL-SURABAYA
A*,E,M,P

IRAQ

Hewlett-Packard Trading S.A.
Service Operation
Al Mansoor City 9B/3/7
BAGHDAD
Tel: 551-49-73
Telex: 212-455 HEPAIRAQ IK
CH,CS

IRELAND

Hewlett-Packard Ireland Ltd.
82/83 Lower Leeson Street
DUBLIN 2
Tel: 0001 608800
Telex: 30439
A,CH,CM,CS,E,M,P
Cardiac Services Ltd.
Kilmore Road
Artane
DUBLIN 5
Tel: (01) 351820
Telex: 30439
M

ISRAEL

Eidan Electronic Instrument Ltd.
P.O.Box 1270
JERUSALEM 91000
16, Ohaliav St.
JERUSALEM 94467
Tel: 533 221, 553 242
Telex: 25231 AB/PAKRD IL
A

Electronics Engineering Division
Motorola Israel Ltd.
16 Kremenetski Street
P.O. Box 25016
TEL-AVIV 67899
Tel: 3 88 388
Telex: 33569 Motil IL
Cable: BASTEL Tel-Aviv
CH,CM,CS,E,M,P

Electronics Engineering Division
Motorola Israel Ltd.
16 Kremenetski Street
P.O. Box 25016
TEL-AVIV 67899
Tel: 3 88 388
Telex: 33569 Motil IL
Cable: BASTEL Tel-Aviv
CH,CM,CS,E,M,P

ITALY

Hewlett-Packard Italiana S.p.A.
Traversa 99C
Via Giulio Petroni, 19
I-70124 **BARI**
Tel: (080) 41-07-44
M

Hewlett-Packard Italiana S.p.A.
Via Martin Luther King, 38/III
I-40132 **Bologna**
Tel: (051) 402394
Telex: 511630
CH,E,MS

Hewlett-Packard Italiana S.p.A.
Via Principe Nicola 43G/C
I-95126 **CATANIA**
Tel: (095) 37-10-87
Telex: 970291
C,P

Hewlett-Packard Italiana S.p.A.
Via G. Di Vittorio 9
I-20063 **CERNUSCO SUL NAVIGLIO**
(Milano)
Tel: (02) 923691
Telex: 334632
A,CH,CM,CS,E,MP,P

Hewlett-Packard Italiana S.p.A.
Via C. Colombo 49
I-20090 **TREZZANO SUL NAVIGLIO**
(Milano)
Tel: (02) 4459041
Telex: 322116
C,M

Hewlett-Packard Italiana S.p.A.
Via Nuova San Rocco a
Capodimonte, 62/A
I-80131 **NAPOLI**
Tel: (081) 7413544
Telex: 710698
A,CH,E

Hewlett-Packard Italiana S.p.A.
Viale G. Modugno 33
I-16156 **GENOVA PEGLI**
Tel: (010) 68-37-07
Telex: 215238
E,C

Hewlett-Packard Italiana S.p.A.
Via Pelizzo 15
I-35128 **PADOVA**
Tel: (049) 664888
Telex: 430315
A,CH,E,MS

Hewlett-Packard Italiana S.p.A.
Viale C. Pavese 340
I-00144 **ROMA EUR**
Tel: (06) 54831
Telex: 610514
A,CH,CM,CS,E,MS,P*

Hewlett-Packard Italiana S.p.A.
Via di Casellina 57/C
I-50018 **SCANDICCI-FIRENZE**
Tel: (055) 753863

Hewlett-Packard Italiana S.p.A.
Corso Svizzera, 185
I-10144 **TORINO**
Tel: (011) 74 4044
Telex: 221079
CH,E

JAPAN

Yokogawa-Hewlett-Packard Ltd.
152-1, Onna
ATSUGI, Kanagawa, 243
Tel: (0462) 28-0451
CM,C*,E

Yokogawa-Hewlett-Packard Ltd.
Meiji-Seimei Bldg. 6F
3-1 Hon Chiba-Cho
CHIBA, 280
Tel: 472 25 7701
E,CH,CS

Yokogawa-Hewlett-Packard Ltd.
Yasuda-Seimei Hiroshima Bldg.
6-11, Hon-dori, Naka-ku
HIROSHIMA, 730
Tel: 82-241-0611

Yokogawa-Hewlett-Packard Ltd.
Towa Building
2-3, Kaigan-dori, 2 Chome Chuo-ku
KOBE, 650
Tel: (078) 392-4791
C,E

Yokogawa-Hewlett-Packard Ltd.
Kumagaya Asahi 82 Bldg
3-4 Tsukuba
KUMAGAYA, Saitama 360
Tel: (0485) 24-6563
CH,CM,E

Yokogawa-Hewlett-Packard Ltd.
Asahi Shinbun Daiichi Seimei Bldg.
4-7, Hanabata-cho
KUMAMOTO, 860
Tel: (0963) 54-7311
CH,E

Yokogawa-Hewlett-Packard Ltd.
Shin-Kyoto Center Bldg.
614, Higashi-Shiokoji-cho
Karasuma-Nishiiru
Shiokoji-dori, Shimogyo-ku
KYOTO, 600
Tel: 075-343-0921
CH,E

Yokogawa-Hewlett-Packard Ltd.
Mito Mitsui Bldg
4-73, Sanno-maru, 1 Chome
MITO, Ibaraki 310
Tel: (0292) 25-7470
CH,CM,E

Yokogawa-Hewlett-Packard Ltd.
Sumitomo Seimei 14-9 Bldg.
Meieki-Minami, 2 Chome
Nakamura-ku
NAGOYA, 450
Tel: (052) 571-5171
CH,CM,CS,E,MS

Yokogawa-Hewlett-Packard Ltd.
Chuo Bldg.,
4-20 Nishinakajima, 5 Chome
Yodogawa-ku
OSAKA, 532
Tel: (06) 304-6021
Telex: YHPOSA 523-3624
A,CH,CM,CS,E,MP,P*

Yokogawa-Hewlett-Packard Ltd.
27-15, Yabe, 1 Chome
SAGAMIHARA Kanagawa, 229
Tel: 0427 59-1311

Yokogawa-Hewlett-Packard Ltd.
Daiichi Seimei Bldg.
7-1, Nishi Shinjuku, 2 Chome
Shinjuku-ku, **TOKYO** 160
Tel: 03-348-4611
CH,E

Yokogawa-Hewlett-Packard Ltd.
29-21 Takaido-Higashi, 3 Chome
Suginami-ku **TOKYO** 168
Tel: (03) 331-6111
Telex: 232-2024 YHPTOK
A,CH,CM,CS,E,MP,P*

Yokogawa-Hewlett-Packard Ltd.
Daiichi Asano Building
2-8, Odori, 5 Chome
UTSUNOMIYA, Tochigi 320
Tel: (0286) 25-7155
CH,CS,E

Yokogawa-Hewlett-Packard Ltd.
Yasuda Seimei Nishiguchi Bldg.
30-4 Tsuruya-cho, 3 Chome
YOKOHAMA 221
Tel: (045) 312-1252
CH,CM,E

JORDAN

Mouasher Cousins Company
P.O. Box 1387
AMMAN
Tel: 24907, 39907
Telex: 21456 SABCO JO
CH,E,MP

KENYA

ADCOM Ltd., Inc., Kenya
P.O.Box 30070
NAIROBI
Tel: 331955
Telex: 22639
E,M

KOREA

Samsung Electronics HP Division
12 Fl. Kinam Bldg.
San 75-31, Yeoksam-Dong
Kangnam-Ku
Yeongdong P.O. Box 72
SEOUL
Tel: 555-7555, 555-5447
Telex: K27364 SAMSAN
A,CH,CM,CS,E,MP

KUWAIT

Al-Khaldiya Trading & Contracting
P.O. Box 830 Safat
KUWAIT
Tel: 42-4910, 41-1726
Telex: 22481 Areeg kt
CH,E,M

Photo & Cine Equipment
P.O. Box 270 Safat
KUWAIT
Tel: 42-2846, 42-3801
Telex: 22247 Matin kt
P

LEBANON

G.M. Dolmadjian
Achrafieh
P.O. Box 165.167
BEIRUT
Tel: 290293
MP**

Computer Information Systems
P.O. Box 11-6274
BEIRUT
Tel: 89 40 73
Telex: 22259
C

LUXEMBOURG

Hewlett-Packard Belgium S.A./N.V.
Blvd de la Woluwe, 100
Woluwedal
B-1200 **BRUSSELS**
Tel: (02) 762-32-00
Telex: 23-494 paloben bru
A,CH,CM,CS,E,MP,P

MALAYSIA

Hewlett-Packard Sales (Malaysia)
Sdn. Bhd.
1st Floor, Bangunan British
American
Jalan Semantan, Damansara Heights
KUALA LUMPUR 23-03
Tel: 943022
Telex: MA31011
A,CH,E,MP*

**MAYLAISIA (Cont'd)**

Protel Engineering
P.O.Box 1917
Lot 6624, Section 64
23/4 Pending Road
Kuching, SARAWAK
Tel: 36299
Telex: MA 70904 PROMAL
Cable: PROTELENG
A,E,M

MALTA

Philip Toledo Ltd.
Notabile Rd.
MRIEHEL
Tel: 447 47, 455 66
Telex: Media MW 649
E,P

MEXICO

Hewlett-Packard Mexicana, S.A.
de C.V.
Av. Periferico Sur No. 6501
Tepepan, Xochimilco
16020 MEXICO D.F.
Tel: 6-76-46-00
Telex: 17-74-507 HEWPACK MEX
A,CH,CS,E,MS,P
Hewlett-Packard Mexicana, S.A.
de C.V.
Ave. Colonia del Valle 409
Col. del Valle
Municipio de Garza Garcia
MONTERREY, Nuevo Leon
Tel: 78 42 41
Telex: 038 410
CH
ECISA
José Vasconcelos No. 218
Col. Condesa Deleg. Cuauhtémoc
MEXICO D.F. 06140
Tel: 553-1206
Telex: 17-72755 ECE ME
M

MOROCCO

Dolbeau
81 rue Karatchi
CASABLANCA
Tel: 3041-82, 3068-38
Telex: 23051, 22822
E

Gerep

2 rue d'Agadir
Boite Postale 156
CASABLANCA
Tel: 272093, 272095
Telex: 23 739
P

NETHERLANDS

Hewlett-Packard Nederland B.V.
Van Heuven Goedhartlaan 121
NL 1181KK AMSTELVEEN
P.O. Box 667
NL 1180 AR AMSTELVEEN
Tel: (020) 47-20-21
Telex: 13 216 HEPA NL
A,CH,CM,CS,E,MP,P
Hewlett-Packard Nederland B.V.
Bongerd 2
NL 2906VK CAPELLE A/D IJSSEL
P.O. Box 41
NL 2900AA CAPELLE A/D IJSSEL
Tel: (10) 51-64-44
Telex: 21261 HEPAC NL
A,CH,CS,E

Hewlett-Packard Nederland B.V.
Pastoor Petersstraat 134-136
NL 5612 LV EINDHOVEN
P.O. Box 2342
NL 5600 CH EINDHOVEN
Tel: (040) 326911
Telex: 51484 hepae nl
A,CH** ,E,M

NEW ZEALAND

Hewlett-Packard (N.Z.) Ltd.
5 Owens Road
P.O. Box 26-189
Epsom, AUCKLAND
Tel: 687-159
Cable: HEWPACK Auckland
CH,CM,E,P*
Hewlett-Packard (N.Z.) Ltd.
4-12 Cruickshank Street
Kilbirnie, WELLINGTON 3
P.O. Box 9443
Courtenay Place, WELLINGTON 3
Tel: 877-199
Cable: HEWPACK Wellington
CH,CM,E,P

Northrop Instruments & Systems Ltd.
369 Khyber Pass Road
P.O. Box 8602
AUCKLAND
Tel: 794-091
Telex: 60605
A,M

Northrop Instruments & Systems Ltd.
110 Mandeville St.
P.O. Box 8388
CHRISTCHURCH
Tel: 486-928
Telex: 4203
A,M

Northrop Instruments & Systems Ltd.
Sturdee House
85-87 Ghuznee Street
P.O. Box 2406
WELLINGTON
Tel: 850-091
Telex: NZ 3380
A,M

NORTHERN IRELAND

See United Kingdom

NORWAY

Hewlett-Packard Norge A/S
Folke Bernadottes vei 50
P.O. Box 3558
N-5033 FYLLINGSDALEN (Bergen)
Tel: 0047/5/16 55 40
Telex: 16621 hpnas n
CH,CS,E,MS
Hewlett-Packard Norge A/S
Østerdalen 16-18
P.O. Box 34
N-1345 ØSTERÅS
Tel: 0047/2/17 11 80
Telex: 16621 hpnas n
A,CH,CM,CS,E,M,P

OMAN

Khimjil Ramdas
P.O. Box 19
MUSCAT
Tel: 722225, 745601
Telex: 3289 BROKER MB MUSCAT
P
Suhail & Saud Bahwan
P.O.Box 169
MUSCAT
Tel: 734 201-3
Telex: 3274 BAHWAN MB

PAKISTAN

Mushko & Company Ltd.
1-B, Street 43
Sector F-8/1
ISLAMABAD
Tel: 51071
Cable: FEMUS Rawalpindi
A,E,M
Mushko & Company Ltd.
Oosman Chambers
Abdullah Haroon Road
KARACHI 0302
Tel: 524 131, 524 132
Telex: 2894 MUSKO PK
Cable: COOPERATOR Karachi
A,E,M,P*

PANAMA

Electrónico Balboa, S.A.
Calle Samuel Lewis, Ed. Alfa
Apartado 4929
PANAMA 5
Tel: 63-6613, 63-6748
Telex: 3483 ELECTRON PG
A,C,M,E,M,P

PERU

Cía Electro Médica S.A.
Los Flamencos 145, San Isidro
Casilla 1030
LIMA 1
Tel: 41-4325, 41-3703
Telex: Pub. Booth 25306
CM,E,M,P

PHILIPPINES

The Online Advanced Systems
Corporation
Rico House, Amorsolo Cor. Herrera
Street
Legaspi Village, Makati
P.O. Box 1510
Metro MANILA
Tel: 85-35-81, 85-34-91, 85-32-21
Telex: 3274 ONLINE
A,CH,CS,E,M
Electronic Specialists and Proponents
Inc.
690-B Epifanio de los Santos Avenue
Cubao, QUEZON CITY
P.O. Box 2649 Manila
Tel: 98-96-81, 98-96-82, 98-96-83
Telex: 40018, 42000 ITT GLOBE
MACKAY BOOTH
P

PORTUGAL

Mundinter
Intercambio Mundial de Comércio
S.A.R.L.
P.O. Box 2761
Av. Antonio Augusto de Aguiar 138
P-LISBON
Tel: (19) 53-21-31, 53-21-37
Telex: 16691 munter p
M
Soquimica
Av. da Liberdade, 220-2
1298 LISBOA Codex
Tel: 56 21 81/2/3
Telex: 13316 SABASA
P
Telectra-Empresa Técnica de
Equipamentos Eléctricos S.A.R.L.
Rua Rodrigo da Fonseca 103
P.O. Box 2531
P-LISBON 1
Tel: (19) 68-60-72
Telex: 12598
CH,CS,E,P

PUERTO RICO

Hewlett-Packard Puerto Rico
Ave. Muñoz Rivera #101
Esq. Calle Ochoa
HATO REY, Puerto Rico 00918
Tel: (809) 754-7800
Hewlett-Packard Puerto Rico
Calle 272 Edificio 203
Urb. Country Club
RIO PIEDRAS, Puerto Rico
P.O. Box 4407
CAROLINA, Puerto Rico 00628
Tel: (809) 762-7255
A,CH,CS

QATAR

Computeabia
P.O. Box 2750
DOHA
Tel: 883555
Telex: 4806 CHPARB
P

Eastern Technical Services
P.O.Box 4747
DOHA

Tel: 329 993
Telex: 4156 EASTEC DH

Nasser Trading & Contracting
P.O.Box 1563
DOHA

Tel: 22170, 23539
Telex: 4439 NASSER DH
M

SAUDI ARABIA

Modern Electronic Establishment
Hewlett-Packard Division
P.O. Box 22015
Thuobah
AL-KHOBAR
Tel: 895-1760, 895-1764
Telex: 671 106 HPMEEK SJ
Cable: ELECTA AL-KHOBAR
CH,CS,E,M

Modern Electronic Establishment
Hewlett-Packard Division
P.O. Box 1228
Redec Plaza, 6th Floor
JEDDAH
Tel: 644 38 48
Telex: 4027 12 FARNAS SJ
Cable: ELECTA JEDDAH
CH,CS,E,M

Modern Electronic Establishment
Hewlett-Packard Division
P.O.Box 22015
RIYADH

Tel: 491-97 15, 491-63 87
Telex: 202049 MEERYD SJ
CH,CS,E,M

Abdul Ghani El Ajou

P.O. Box 78
RIYADH
Tel: 40 41 717
Telex: 200 932 EL AJOU
P

SCOTLAND

See United Kingdom

SINGAPORE

Hewlett-Packard Singapore (Sales)
Pte. Ltd.
#08-00 Inchange House
450-2 Alexandra Road
P.O. Box 58 Alexandra Rd. Post Office
SINGAPORE, 9115
Tel: 631788
Telex: HPSGSO RS 34209
Cable: HEWPACK, Singapore
A,CH,CS,E,MS,P



SALES & SUPPORT OFFICES

Arranged alphabetically by country

SINGAPORE (Cont'd)

Dynamar International Ltd.
Unit 05-11 Block 6
Kolam Ayer Industrial Estate
SINGAPORE 1334
Tel: 747-6188
Telex: RS 26283
CM

SOUTH AFRICA

Hewlett-Packard So Africa (Pty.) Ltd.
P.O. Box 120
Howard Place **CAPE PROVINCE 7450**
Pine Park Center, Forest Drive,
Pinelands

CAPE PROVINCE 7405

Tel: 53-7954
Telex: 57-20006
A,CH,CM,E,MS,P

Hewlett-Packard So Africa (Pty.) Ltd.
P.O. Box 37099
92 Overport Drive
DURBAN 4067
Tel: 28-4178, 28-4179, 28-4110
Telex: 6-22954
CH,CM

Hewlett-Packard So Africa (Pty.) Ltd.
6 Linton Arcade
511 Cape Road
Linton Grange
PORT ELIZABETH 6000
Tel: 041-302148
CH

Hewlett-Packard So Africa (Pty.) Ltd.
P.O. Box 33345
Glenstantia 0010 **TRANSVAAL**
1st Floor East
Constantia Park Ridge Shopping
Centre
Constantia Park
PRETORIA
Tel: 982043
Telex: 32163
CH,E

Hewlett-Packard So Africa (Pty.) Ltd.
Private Bag Wendywood
SANDTON 2144
Tel: 802-5111, 802-5125
Telex: 4-20877
Cable: HEWPACK Johannesburg
A,CH,CM,CS,E,MS,P

SPAIN

Hewlett-Packard Española S.A.
Calle Entenza, 321
E-BARCELONA 29
Tel: 322.24.51, 321.73.54
Telex: 52603 hpbee
A,CH,CS,E,MS,P

Hewlett-Packard Española S.A.
Calle San Vicente S/No
Edificio Albia II
E-BILBAO 1
Tel: 423.83.06
A,CH,E,MS

Hewlett-Packard Española S.A.
Cta. de la Coruña, Km. 16, 400
Las Rozas
E-MADRID
Tel: (1) 637.00.11
CH,CS,M

Hewlett-Packard Española S.A.
Avda. S. Francisco Javier, S/no
Planta 10. Edificio Sevilla 2,
E-SEVILLA 5
Tel: 64.44.54
Telex: 72933
A,CS,MS,P

Hewlett-Packard Española S.A.
Calle Ramon Gorrillo, 1 (Entlo.3)
E-VALENCIA 10
Abu Rumnaneh
Tel: 361-1354
CH,P

SWEDEN

Hewlett-Packard Sverige AB
Sunnanvagen 14K
S-22226 **LUND**
Tel: (046) 13-69-79
Telex: (854) 17886 (via Spånga
office)
CH

Hewlett-Packard Sverige AB
Östra Tullgatan 3
S-21128 **MALMÖ**
Tel: (040) 70270
Telex: (854) 17886 (via Spånga
office)

Hewlett-Packard Sverige AB
Våstra Vintergatan 9
S-70344 **ÖREBRO**
Tel: (19) 10-48-80
Telex: (854) 17886 (via Spånga
office)
CH

Hewlett-Packard Sverige AB
Skalholtsgatan 9, Kista
Box 19
S-16393 **SPÅNGA**
Tel: (08) 750-2000
Telex: (854) 17886
Telefax: (08) 7527781
A,CH,CM,CS,E,MS,P

Hewlett-Packard Sverige AB
Frötällsgatan 30
S-42132 **VÄSTRA-FRÖLUNDA**
Tel: (031) 49-09-50
Telex: (854) 17886 (via Spånga
office)
CH,E,P

SWITZERLAND

Hewlett-Packard (Schweiz) AG
Clarastrasse 12
CH-4058 **BASEL**
Tel: (61) 33-59-20
A

Hewlett-Packard (Schweiz) AG
7, rue du Bois-du-Lan
Case Postale 365
CH-1217 **MEYRIN 2**
Tel: (0041) 22-83-11-11
Telex: 27333 HPAG CH
CH,CM,CS

Hewlett-Packard (Schweiz) AG
Allmend 2
CH-8967 **WIDEN**
Tel: (0041) 57 31 21 11
Telex: 53933 hpag ch
Cable: HPAG CH
A,CH,CM,CS,E,MS,P

SYRIA

General Electronic Inc.
Nuri Basha Ahnaf Ebn Kays Street
P.O. Box 5781
DAMASCUS
Tel: 33-24-87
Telex: 411 215
Cable: ELECTROBOR DAMASCUS
E

Middle East Electronics
P.O. Box 2308
Abu Rumnaneh
DAMASCUS
Tel: 33 4 5 92
Telex: 411 304
M

TAIWAN

Hewlett-Packard Far East Ltd.
Kaohsiung Office
2/F 68-2, Chung Cheng 3rd Road
KAOHSIUNG
Tel: (07) 241-2318
CH,CS,E

Hewlett-Packard Far East Ltd.
Taiwan Branch
8th Floor
337 Fu Hsing North Road
TAIPEI

Tel: (02) 712-0404
Telex: 24439 HEWPACK
Cable: HEWPACK Taipei
A,CH,CM,CS,E,M,P
Ing Lih Trading Co.
3rd Floor, 7 Jen-Ai Road, Sec. 2
TAIPEI 100
Tel: (02) 3948191
Cable: INGLIH TAIPEI
A

THAILAND

Unimesa
30 Patpong Ave., Suriwong
BANGKOK 5
Tel: 235-5727
Telex: 84439 Simonco TH
Cable: UNIMESA Bangkok
A,CH,CS,E,M
Bangkok Business Equipment Ltd.
5/5-6 Dejo Road
BANGKOK
Tel: 234-8670, 234-8671
Telex: 87669-BEQUIPT TH
Cable: BUSIQUIPT Bangkok
P

TRINIDAD & TOBAGO

Caribbean Telecoms Ltd.
50/A Jerningham Avenue
P.O. Box 732
PORT-OF-SPAIN
Tel: 62-44213, 62-44214
Telex: 235,272 HUGCO WG
CM,E,M,P

TUNISIA

Tunisie Electronique
31 Avenue de la Liberte
TUNIS
Tel: 280-144
E,P

Corema
1 ter. Av. de Carthage
TUNIS
Tel: 253-821
Telex: 12319 CABAM TN
M

TURKEY

Teknim Company Ltd.
Iran Caddesi No. 7
Kavaklidere, **ANKARA**
Tel: 275800
Telex: 42155 TKNM TR
E

E.M.A.
Medina Eldem Sokak No.41/6
Yuksel Caddesi
ANKARA
Tel: 175 622
Telex: 42 591
M

UNITED ARAB EMIRATES

Emilac Ltd.
P.O. Box 2711
ABU DHABI
Tel: 82 04 19-20
Cable: EMITAC ABUDHABI
Emilac Ltd.
P.O. Box 1641
SHARJAH
Tel: 591 181
Telex: 68136 Emilac Sh
CH,CS,E,M,P

UNITED KINGDOM

GREAT BRITAIN

Hewlett-Packard Ltd.
Trafalgar House
Navigation Road
ALTRINCHAM
Cheshire WA14 1NU
Tel: 061 928 6422
Telex: 668068
A,CH,CS,E,M,MS,P

Hewlett-Packard Ltd.
Elstree House, Elstree Way
BOREHAMWOOD, Herts WD6 1SG
Tel: 01 207 5000
Telex: 8952716
E,CH,CS,P

Hewlett-Packard Ltd.
Oakfield House, Oakfield Grove
Clifton **BRISTOL**, Avon BS8 2BN
Tel: 0272 736806
Telex: 444302
CH,CS,E,P

Hewlett-Packard Ltd.
Bridewell House
Bridewell Place
LONDON EC4V 6BS
Tel: 01 583 6565
Telex: 298163
CH,CS,P

Hewlett-Packard Ltd.
Fourier House
257-263 High Street
LONDON COLNEY
Herts. AL2 1HA, St. Albans
Tel: 0727 24400
Telex: 1-8952716
CH,CS

Hewlett-Packard Ltd.
Pontefract Road
NORMANTON, West Yorkshire WF6 1RN
Tel: 0924 895566
Telex: 557355
CH,CS,P

Hewlett-Packard Ltd.
The Quadrangle
106-118 Station Road
REDHILL, Surrey RH1 1PS
Tel: 0737 68655
Telex: 947234
CH,CS,E,P

**GREAT BRITAIN (Cont'd)**

Hewlett-Packard Ltd.
Avon House
435 Stratford Road
Shirley, **SOLIHULL**, West Midlands
B90 4BL

Tel: 021 745 8800
Telex: 339105
CH,CS,E,P

Hewlett-Packard Ltd.
West End House
41 High Street, West End
SOUTHAMPTON

Hampshire SO3 3DQ
Tel: 04218 6767
Telex: 477138
CH,CS,P

Hewlett-Packard Ltd.
Eskdale Rd.
Winnersh, **WOKINGHAM**
Berkshire RG11 5DZ
Tel: 0734 696622
Telex: 848884
E

Hewlett-Packard Ltd.
King Street Lane
Winnersh, **WOKINGHAM**
Berkshire RG11 5AR
Tel: 0734 784774
Telex: 847178
A,CH,CS,E,M,MP,P

Hewlett-Packard Ltd.
Nine Mile Ride
Easthampstead, **WOKINGHAM**
Berkshire, 3RG11 3LL
Tel: 0344 773100
Telex: 848805
CH,CS,E,P

IRELAND**NORTHERN IRELAND**

Hewlett-Packard Ltd.
Cardiac Services Building
95A Finaghy Road South
BELFAST BT10 0BY
Tel: 0232 625-566
Telex: 747626
CH,CS

SCOTLAND

Hewlett-Packard Ltd.
SOUTH QUEENSFERRY
West Lothian, EH30 9TG
Tel: 031 331 1188
Telex: 72682
CH,CM,CS,E,M,P

UNITED STATES**Alabama**

Hewlett-Packard Co.
700 Century Park South, Suite 128
BIRMINGHAM, AL 35226
Tel: (205) 822-6802
A,CH,M

Hewlett-Packard Co.
420 Wynn Drive
HUNTSVILLE, AL 35805
P.O. Box 7700
HUNTSVILLE, AL 35807
Tel: (205) 830-2000
CH,CM,CS,E,M*

Arizona

Hewlett-Packard Co.
8080 Pointe Parkway West
PHOENIX, AZ 85044
Tel: (602) 273-8000
A,CH,CM,CS,E,MS

Hewlett-Packard Co.
2424 East Aragon Road
TUCSON, AZ 85706
Tel: (602) 889-4631
CH,E,MS**

California

Hewlett-Packard Co.
99 South Hill Dr.
BRISBANE, CA 94005
Tel: (415) 330-2500
CH,CS

Hewlett-Packard Co.
P.O. Box 7830 (93747)
5060 E. Clinton Avenue, Suite 102
FRESNO, CA 93727
Tel: (209) 252-9652
CH,CS,MS

Hewlett-Packard Co.
P.O. Box 4230
1430 East Orangethorpe
FULLERTON, CA 92631
Tel: (714) 870-1000
CH,CM,CS,E,MP

Hewlett-Packard Co.
320 S. Kellogg, Suite B
GOLETA, CA 93117
Tel: (805) 967-3405
CH

Hewlett-Packard Co.
5400 W. Rosecrans Boulevard
LAWDALE, CA 90260
P.O. Box 92105
LOS ANGELES, CA 90009
Tel: (213) 970-7500
Telex: 910-325-6608
CH,CM,CS,MP

Hewlett-Packard Co.
3155 Porter Oaks Drive
PALO ALTO, CA 94304
Tel: (415) 857-8000
CH,CS,E

Hewlett-Packard Co.
4244 So. Market Court, Suite A
P.O. Box 15976
SACRAMENTO, CA 95852
Tel: (916) 929-7222
A*,CH,CS,E,MS

Hewlett-Packard Co.
9606 Aero Drive
P.O. Box 23333
SAN DIEGO, CA 92139
Tel: (619) 279-3200
CH,CM,CS,E,MP

Hewlett-Packard Co.
2305 Camino Ramon "C"
SAN RAMON, CA 94583
Tel: (415) 838-5900
CH,CS

Hewlett-Packard Co.
3005 Scott Boulevard
SANTA CLARA, CA 95050
Tel: (408) 988-7000
Telex: 910-338-0586
A,CH,CM,CS,E,MP

Hewlett-Packard Co.
5703 Corsa Avenue
WESTLAKE VILLAGE, CA 91362
Tel: (213) 706-6800
E*,CH*,CS*

Colorado

Hewlett-Packard Co.
24 Inverness Place, East
ENGLEWOOD, CO 80112
Tel: (303) 649-5000
A,CH,CM,CS,E,MS

Connecticut

Hewlett-Packard Co.
47 Barnes Industrial Road South
P.O. Box 5007
WALLINGFORD, CT 06492
Tel: (203) 265-7801
A,CH,CM,CS,E,MS

Florida

Hewlett-Packard Co.
2901 N.W. 62nd Street
P.O. Box 24210
FORT LAUDERDALE, FL 33307
Tel: (305) 973-2600
CH,CS,E,MP

Hewlett-Packard Co.
6177 Lake Ellenor Drive
P.O. Box 13910
ORLANDO, FL 32859
Tel: (305) 859-2900
A,CH,CM,CS,E,MS

Hewlett-Packard Co.
5750B N. Hoover Blvd., Suite 123
P.O. Box 15200
TAMPA, FL 33614
Tel: (813) 884-3282
A*,CH,CM,CS,E*,M*

Georgia

Hewlett-Packard Co.
2000 South Park Place
P.O. Box 105005
ATLANTA, GA 30348
Tel: (404) 955-1500
Telex: 810-766-4890
A,CH,CM,CS,E,MP

Hawaii

Hewlett-Packard Co.
Kawaiahao Plaza, Suite 190
567 South King Street
HONOLULU, HI 96813
Tel: (808) 526-1555
A,CH,E,MS

Illinois

Hewlett-Packard Co.
304 Eldorado Road
P.O. Box 1607
BLOOMINGTON, IL 61701
Tel: (309) 662-9411
CH,MS**

Hewlett-Packard Co.
1100 31st Street, Suite 100
DOWNERS GROVE, IL 60515
Tel: (312) 960-5760
CH,CS

Hewlett-Packard Co.
5201 Tollview Drive
ROLLING MEADOWS, IL 60008
Tel: (312) 255-9800
Telex: 910-687-1066
A,CH,CM,CS,E,MP

Indiana

Hewlett-Packard Co.
7301 No. Shadeland Avenue
P.O. Box 50807
INDIANAPOLIS, IN 46250
Tel: (317) 842-1000
A,CH,CM,CS,E,MS

Iowa

Hewlett-Packard Co.
1776 22nd Street, Suite 1
WEST DES MOINES, IA 50265
Tel: (515) 224-1435
CH,MS**

Kansas

Hewlett-Packard Co.
7804 East Funston Road, #203
WICHITA, KS 67207
Tel: (316) 684-8491
CH

Kentucky

Hewlett-Packard Co.
10300 Linn Station Road, #100
LOUISVILLE, KY 40223
Tel: (502) 426-0100
A,CH,CS,MS

Louisiana

Hewlett-Packard Co.
160 James Drive East
ST. ROSE, LA 70087
P.O. Box 1449
KENNER, LA 70063
Tel: (504) 467-4100
A,CH,CS,E,MS

Maryland

Hewlett-Packard Co.
3701 Koppers Street
BALTIMORE, MD 21227
Tel: (301) 644-5800
Telex: 710-862-1943
A,CH,CM,CS,E,MS

Hewlett-Packard Co.
2 Choke Cherry Road
ROCKVILLE, MD 20850
Tel: (301) 948-6370
A,CH,CM,CS,E,MP

Massachusetts

Hewlett-Packard Co.
1775 Minuteman Road
ANDOVER, MA 01810
Tel: (617) 682-1500
A,C,CH,CS,CM,E,MP,P*
Hewlett-Packard Co.
32 Hartwell Avenue
LEXINGTON, MA 02173
Tel: (617) 861-8960
CH,CS,E

Michigan

Hewlett-Packard Co.
4326 Cascade Road S.E.
GRAND RAPIDS, MI 49506
Tel: (616) 957-1970
CH,CS,MS

Hewlett-Packard Co.
1771 W. Big Beaver Road
TROY, MI 48084
Tel: (313) 643-6474
CH,CS

Minnesota

Hewlett-Packard Co.
2025 W. Larpenteur Ave.
ST. PAUL, MN 55113
Tel: (612) 644-1100
A,CH,CM,CS,E,MP

Missouri

Hewlett-Packard Co.
11131 Colorado Avenue
KANSAS CITY, MO 64137
Tel: (816) 763-8000
A,CH,CM,CS,E,MS

Hewlett-Packard Co.
13001 Hollenberg Drive
BRIDGETON, MO 63044
Tel: (314) 344-5100
A,CH,CS,E,MP



SALES & SUPPORT OFFICES

Arranged alphabetically by country

UNITED STATES (Cont'd)

Nebraska

Hewlett-Packard
10824 Old Mill Rd., Suite 3
OMAHA, NE 68154
Tel: (402) 334-1813
CM,MS

New Jersey

Hewlett-Packard Co.
120 W. Century Road
PARAMUS, NJ 07652
Tel: (201) 265-5000
A,CH,CM,CS,E,MP
Hewlett-Packard Co.
60 New England Av. West
PISCATAWAY, NJ 08854
Tel: (201) 981-1199
A,CH,CM,CS,E

New Mexico

Hewlett-Packard Co.
11300 Lomas Blvd.,N.E.
P.O. Box 11634
ALBUQUERQUE, NM 87112
Tel: (505) 292-1330
CH,CS,E,MS

New York

Hewlett-Packard Co.
5 Computer Drive South
ALBANY, NY 12205
Tel: (518) 458-1550
A,CH,E,MS
Hewlett-Packard Co.
9600 Main Street
P.O. Box AC
CLARENCE, NY 14031
Tel: (716) 759-8621
CH
Hewlett-Packard Co.
200 Cross Keys Office Park
FAIRPORT, NY 14450
Tel: (716) 223-9950
CH,CM,CS,E,MS
Hewlett-Packard Co.
7641 Henry Clay Blvd.
LIVERPOOL, NY 13088
Tel: (315) 451-1820
A,CH,CM,E,MS
Hewlett-Packard Co.
No. 1 Pennsylvania Plaza
55th Floor
34th Street & 8th Avenue
MANHATTAN NY 10119
Tel: (212) 971-0800
CH,CS,E*,M*
Hewlett-Packard Co.
250 Westchester Avenue
WHITE PLAINS, NY 10604
Tel: (914) 684-6100
CM,CH,CS,E
Hewlett-Packard Co.
3 Crossways Park West
WOODBURY, NY 11797
Tel: (516) 921-0300
A,CH,CM,CS,E,MS
North Carolina
Hewlett-Packard Co.
5605 Roanne Way
P.O. Box 26500
GREENSBORO, NC 27420
Tel: (919) 852-1800
A,CH,CM,CS,E,MS

Ohio

Hewlett-Packard Co.
9920 Carver Road
CINCINNATI, OH 45242
Tel: (513) 891-9870
CH,CS,MS
Hewlett-Packard Co.
16500 Sprague Road
CLEVELAND, OH 44130
Tel: (216) 243-7300
A,CH,CM,CS,E,MS
Hewlett-Packard Co.
962 Crupper Ave.
COLUMBUS, OH 43229
Tel: (614) 436-1041
Eff: Nov. 25, 1983
675 Brookside Blvd.
WESTERVILLE, OH 43081
CH,CM,CS,E*
Hewlett-Packard Co.
330 Progress Rd.
DAYTON, OH 45449
Tel: (513) 859-8202
A,CH,CM,E*,MS
Oklahoma
Hewlett-Packard Co.
304 N. Meridian, Suite A
P.O. Box 75609
OKLAHOMA CITY, OK 73147
Tel: (405) 946-9499
A*,CH,E*,MS
Hewlett-Packard Co.
3840 S. 103rd E. Avenue, #100
P.O. Box 35747
TULSA, OK 74153
Tel: (918) 665-3300
A**,CH,CS,M*
Oregon
Hewlett-Packard Co.
9255 S. W. Pioneer Court
P.O. Box 328
WILSONVILLE, OR 97070
Tel: (503) 682-8000
A,CH,CS,E*,MS
Pennsylvania
Hewlett-Packard Co.
111 Zeta Drive
PITTSBURGH, PA 15238
Tel: (412) 782-0400
A,CH,CS,E,MP
Hewlett-Packard Co.
2750 Monroe Boulevard
P.O. Box 713
VALLEY FORGE, PA 19482
Tel: (215) 666-9000
A,CH,CM,E,M
South Carolina
Hewlett-Packard Co.
Brookside Park, Suite 122
1 Harbison Way
P.O. Box 21708
COLUMBIA, SC 29221
Tel: (803) 732-0400
CH,E,MS
Hewlett-Packard Co.
Koger Executive Center
Chesterfield Bldg., Suite 124
GREENVILLE, SC 29615
Tel: (803) 297-4120
Tennessee
Hewlett-Packard Co.
224 Peters Road, Suite 102
P.O. Box 22490
KNOXVILLE, TN 37922
Tel: (615) 691-2371
A*,CH,MS

Hewlett-Packard Co.
3070 Directors Row
MEMPHIS, TN 38131
Tel: (901) 346-8370
A,CH,MS

Texas

Hewlett-Packard Co.
4171 North Mesa
Suite C-110
EL PASO, TX 79902
Tel: (915) 533-3555
CH,E*,MS*
Hewlett-Packard Co.
10535 Harwin Drive
P.O. Box 42816
HOUSTON, TX 77042
Tel: (713) 776-6400
A,CH,CM,CS,E,MP
Hewlett-Packard Co.
930 E. Campbell Rd.
P.O. Box 1270
RICHARDSON, TX 75080
Tel: (214) 231-6101
A,CH,CM,CS,E,MP
Hewlett-Packard Co.
1020 Central Parkway South
P.O. Box 32993
SAN ANTONIO, TX 78216
Tel: (512) 494-9336
CH,CS,E,MS
Utah
Hewlett-Packard Co.
3530 W. 2100 South
SALT LAKE CITY, UT 84119
Tel: (801) 974-1700
A,CH,CS,E,MS

Virginia

Hewlett-Packard Co.
4305 Cox Road
GLEN ALLEN, VA 23060
P.O. Box 9669
RICHMOND, VA 23228
Tel: (804) 747-7750
A,CH,CS,E,MS
Washington
Hewlett-Packard Co.
15815 S.E. 37th Street
BELLEVUE, WA 98006
Tel: (206) 643-4000
A,CH,CM,CS,E,MP
Hewlett-Packard Co.
Suite A
708 North Argonne Road
SPOKANE, WA 99212
Tel: (509) 922-7000
CH,CS

West Virginia

Hewlett-Packard Co.
4604 MacCorkle Ave.
P.O. Box 4297
CHARLESTON, WV 25304
Tel: (304) 925-0492
A,MS
Wisconsin
Hewlett-Packard Co.
150 S. Sunny Slope Road
BROOKFIELD, WI 53005
Tel: (414) 784-8800
A,CH,CS,E*,MP

URUGUAY

Pablo Ferrando S.A.C. e i.
Avenida Italia 2877
Casilla de Correo 370
MONTEVIDEO
Tel: 80-2586
Telex: Public Booth 901
A,CM,E,M

VENEZUELA

Hewlett-Packard de Venezuela C.A.
3RA Transversal Los Ruices Norte
Edificio Segre 1, 2 & 3
Apartado 50933
CARACAS 1071
Tel: 239-4133
Telex: 251046 HEWPACK
A,CH,CS,E,MS,P
Hewlett-Packard de Venezuela C.A.
Calle 72-Entre 3H y 3Y, No. 3H-40
Edificio Ada-Evelyn, Local B
Apartado 2646
4001, **MARACAIBO**, Estado Zulia
Tel: (061) 80.304
C,E*
Hewlett-Packard de Venezuela C.A.
Calle Vargas Rondon
Edificio Seguros Carabobo, Piso 10
VALENCIA
Tel: (041) 51 385
CH,CS,P
Bioelectronica Medica C.A.
Calle Buen Pastor
Edif. Cota Mil-Piso 2 y Semi Sotano 1
Bolivia Norte
Apartado 50710 CARACAS 1050A
Tel: 239 84 41
Telex: 26518
ZIMBABWE
Field Technical Sales
45 Kelvin Road, North
P.B. 3458
SALISBURY
Tel: 705 231
Telex: 4-122 RH
C,E,M,P
July 1983 5952-6900
Indicates main office
HP distributors are printed in italics.

READER COMMENT SHEET

HP 1000 M/E/F-SERIES FIRMWARE
Installation and Reference Manual

12791-90001

September 1983

Update No. _____
(If Applicable)

We welcome your evaluation of this manual. Your comments and suggestions help us improve our publications. Please use additional pages if necessary. If you have technical questions or if you want to order publications, make your inquiries to a representative of your local HP office. Thank you for your comments! No postage necessary if mailed in the U.S.A.

FROM:

Name _____

Company _____

Address _____

Phone No. _____ **Ext.** _____

FOLD

FOLD



NO POSTAGE
NECESSARY
IF MAILED
IN THE
UNITED STATES

BUSINESS REPLY MAIL

FIRST CLASS PERMIT NO. 141 CUPERTINO, CA.

— POSTAGE WILL BE PAID BY —

Hewlett-Packard Company
Data Systems Division
11000 Wolfe Road
Cupertino, California 95014
ATTN: Technical Publications

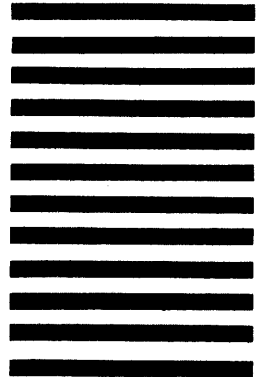

FOLD

FOLD



MANUAL PART NO. 12791-90001
Printed in U.S.A. September 1983
E0983

HEWLETT-PACKARD COMPANY
Data Systems Division
11000 Wolfe Road
Cupertino, California 95014