

# Intel® PRO/100+

## Dual Port Server Adapter

### *Installation Guide*



# Where to go for more information

## Readme files



For detailed information about the adapter, see the readme files. To view them, insert the Configuration and Drivers disk in a disk drive, switch to that drive, and type

SETUP /README 

Topics include:

- Installing adapter drivers
- Latest news and general adapter information
- Hardware specifications and cabling information
- Adapter installation and special configurations
- Running diagnostics
- Setting up Adapter Teaming

## Online services



You can use your modem or Internet connection to download drivers, troubleshooting tips, and more. (When downloading new drivers, make sure the archive is for the **PRO/100+ Dual Port Server** adapter (not PRO/100). See the last page of the manual for details.



An Intel product, when used in accordance with its associated documentation, is "Year 2000 Capable" when, upon installation, it accurately stores, displays, processes, provides, and/or receives date data from, into, and between the twentieth and twenty-first centuries. This includes leap year calculations, provided that all other technology used in combination with said product properly exchanges date data with it.

See [www.intel.com/support/year2000](http://www.intel.com/support/year2000) for more information.

Copyright © 1995-1998 Intel Corporation. All rights reserved.  
Intel Corporation, 5200 N.E. Elam Young Parkway, Hillsboro, Oregon 97124-6497

Intel Corporation assumes no responsibility for errors or omissions in this guide. Nor does Intel make any commitment to update the information contained herein.

\* Other product and corporate names may be trademarks of other companies and are used only for explanation and to the owners' benefit, without intent to infringe.

# Installation Overview

<b>Put the Adapter(s) in the Server .....</b>	<b>2</b>
<b>Connect the Network Cables .....</b>	<b>3</b>
<b>Configure the Adapters and Install the Drivers .....</b>	<b>4</b>
Windows NT* Automatic Configuration .....	4
Novell NetWare* 4.1x .....	7
Windows* 95 .....	8
Windows 98 .....	10
DOS and Windows 3.1 Setup for Novell NetWare Clients .....	11
NetWare Server 3.11, 3.12, Client 32, UNIX*, OS/2*, Banyan, and Other Operating Systems .....	13
<b>Installing Multiple Adapters .....</b>	<b>13</b>
<b>Select Duplex Mode (Optional) .....</b>	<b>14</b>
<b>Choose Adapter Teaming Options .....</b>	<b>16</b>
Setting Up Adapter Fault Tolerance Only .....	16
Setting Up Adaptive Load Balancing .....	18
Setting Up Fast EtherChannel* .....	20
Teaming Options Supported by OS and Protocol .....	22
Using the Adapter Teaming Configuration Dialog Box ..	23
<b>Troubleshooting and FAQs .....</b>	<b>24</b>
If the Adapter Can't Connect to the Network .....	24
Testing the Adapter (Diagnostics) .....	25
Viewing the Status of an Adapter in Event Viewer .....	26
Frequently Asked Questions (FAQs) .....	27
<b>Technical Information .....</b>	<b>28</b>
PCI Installation Tips .....	28
"Push" Installation for Windows 95 .....	29
Fast Ethernet Wiring .....	29
Fast Ethernet Hubs and Switches .....	29
Switching Hubs .....	30
Adapter Specifications .....	30
<b>Customer Support .....</b>	<b>34</b>

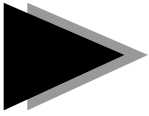

# Put the Adapter(s) in the Server

- 1 Turn off the computer and unplug the power cord. Then remove its cover.



Warning: Turn off and unplug power to the computer before removing its cover. Failure to do so could shock you and may damage the adapter or computer.

- 2 Remove the cover bracket from a PCI busmaster adapter slot. In most servers, all slots are busmaster-enabled. If you have configuration problems, see your server's documentation to determine if the PCI slots are busmaster-enabled.
- 3 Write down the adapter's 12-digit, hexadecimal Ethernet address that is printed on a sticker placed on the adapter. Note also which adapter this address applies to. You will need this number often in configuring and monitoring the adapter.



For dual port adapters, the Ethernet address printed on the identification sticker refers to the port closest to the PCI slot. Increment this address by one for the second port. For example, if the Ethernet address on the sticker reads 00A0C93F7F77, then the address of the port furthest from the PCI slot would be 00A0C93F7F78.

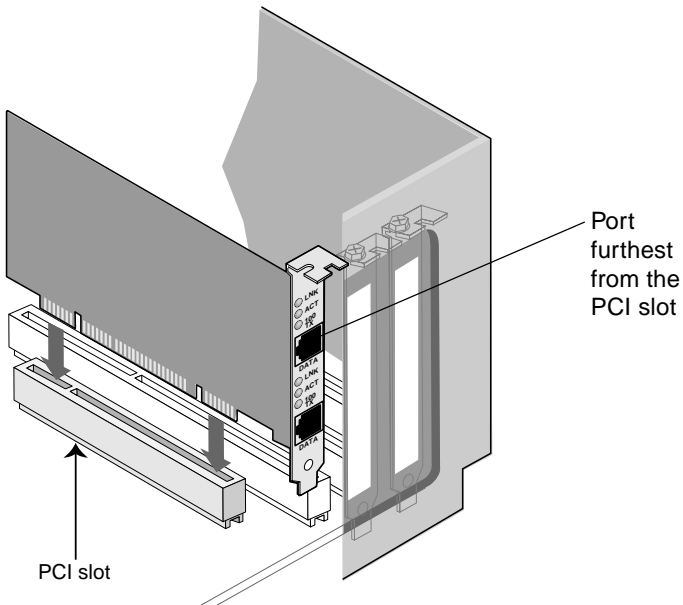

- 4 Push the adapter into the slot until it's seated firmly. Then secure the adapter bracket.  
If you're installing multiple adapters, see *Installing Multiple Adapters*.
- 5 Replace the computer cover and plug in the power cord.

## Connect the Network Cables

- 1 Connect a TPE network cable to each port of the adapter as shown below.

For 100BASE-TX, your network cable must be Category 5, twisted-pair wiring. If you plan to run the adapter at 100 Mbps, it must be connected to a 100BASE-TX hub or switch (not a 100BASE-T4 hub).

For 10BASE-T, use Category 3, 4, or 5 twisted-pair wiring. If you want to use this adapter in a residential environment, you must use a Category 5 cable.

### 100BASE-TX Wiring

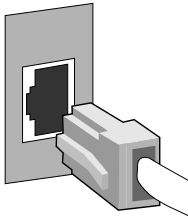

**Twisted Pair Ethernet (TPE).** Use Category 5 cable and an RJ-45 connector for this adapter. Do not use Category 3 wiring at 100 Mbps. At 100 Mbps, connect to a TX hub, not a T4 hub. For full duplex, see *Select Duplex Mode* further in this guide.



**NOTE:** For more information on 100BASE-TX wiring requirements and limitations, see *Fast Ethernet Wiring* and refer to the CABLE100.TXT file on the installation disk.

- 2 To configure the adapter, continue with the procedures specific to your operating system on the following pages.



# Configure the Adapters and Install the Drivers



## Windows NT Automatic Configuration

PCI computers automatically detect and configure PCI-compliant adapters while booting. The adapter IRQ level and I/O address are automatically set by the BIOS each time you start your computer.

Start your computer to automatically configure the adapter. Configuration is complete when Windows NT starts or the DOS prompt appears.

If your computer displays an error while booting, it may require additional steps to configure. See *PCI Installation Tips* for more information.



## Windows NT Version 4.0 Only

After putting the adapter in the computer, connecting the cables, and starting Windows NT, you need to install the correct drivers.

- 1 Double-click the Network icon in the Control Panel.
- 2 Click the Adapters tab.
- 3 Click Add. You'll see a list of adapters.
- 4 **Don't select an adapter from this list.** Instead, insert the PRO/100+ Server adapter disk into your disk drive and click Have Disk.
- 5 Type D:\ (for CD) or A:\ (for floppy) in the dialog box and click OK. Then follow the prompts to complete the installation. When both adapters are added, you'll see two new adapters listed in the Network adapters list, one for each port of the Intel® PRO/100+ Dual Port Server adapter. Even if you've installed multiple PRO/100+ Server adapters, all are configured at this time.
- 6 Select one of the new adapter listings and click Properties to run PROSet and view the adapter configuration. Adapter hardware diagnostics are available only when the drivers aren't loaded (before you restart your computer). Driver diagnostics are available when the drivers are loaded.

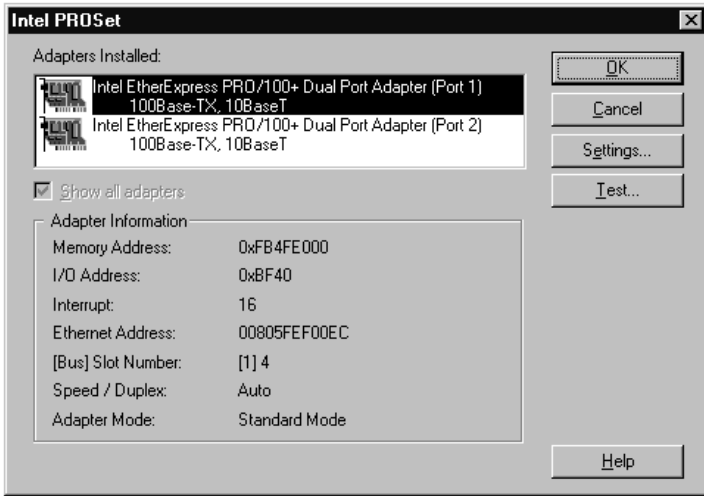

PROSet is an enhanced utility that you can use to easily configure and test your adapter in Windows NT. PROSet also displays the computer resources that were assigned to each adapter installed.

- 7 Click OK in the main PROSet window to return to Windows NT.
- 8 The adapters now appear on the list in the Network window. Click Close to finish.
- 9 Restart Windows NT when prompted.

To set duplexing options, continue to the section *Select Duplex Mode*.

To set teaming options, continue to the section *Choose Adapter Teaming Options*.

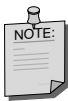

To run the PROSet utility at any time, go to the Adapters tab in the Network control panel and click Properties.



## Windows NT Version 3.51 Only

After putting the adapter in the computer, connecting the cables, and starting Windows NT, you need to install the correct drivers and test the adapter.

- 1 Double-click the Network icon in the Control Panel.
- 2 Click Add Adapter.
- 3 When the list of adapters appears, scroll to the end of the list and select *<Other> Requires disk from manufacturer*.
- 4 Insert the PRO/100+ Server adapter disk in the drive and click OK. Drivers and the PROSet utility are installed. To start PROSet, click Configure.

PROSet is an enhanced utility that you can use to easily configure and test your adapter in Windows NT. PROSet also displays the computer resources that were assigned to each adapter installed. The PROSet main window is shown on the preceding page.

- 5 Click OK in the PROSet main window to return to Windows NT. You'll see the Network Settings dialog box.
- 6 Click OK and remove the installation disk. When prompted, restart Windows NT.

To set duplexing options, see *Select Duplex Mode*.

## Windows NT Troubleshooting



If Windows NT reports an error or you can't connect to the network, try the suggestions here first, then turn to *Troubleshooting and FAQs* if necessary.

- Make sure that you use the drivers for this adapter. Drivers are located on the PRO/100+ Server adapter disk.
- Make sure the driver is loaded and the protocols are bound. Check the Network Bindings dialog box in Windows NT.
- Check the Windows NT Event Viewer for error messages.
- If you are attaching to a NetWare network, check your frame type and verify that NetWare client or server software has been installed.
- Test the adapter with PROSet. After installing the adapter you can run PROSet from your hard disk. To do this, double-click the PROSet icon in the Control Panel. Click Test to run diagnostics. For additional information, click Help in the PROSet window.
- Check with your LAN administrator — you may need to install supplemental networking software.





## Novell NetWare 4.1x Only

Use the NetWare Install program to install the PRO/100+ adapter driver in Novell NetWare 4.1x. For Novell NetWare 3.11 and 3.12, see the Readme files. The following procedure is a condensed description of the installation process.



Prior to installing, either load DOS or NetWare drivers for your server's CD-ROM drive **or** create a floppy disk from the compact disc on a different computer. See Readme.txt in the root of the compact disc for details.

- 1 From the NetWare console, type `LOAD INSTALL` 
- 2 From the Installation Options screen, choose "Driver options" and press Enter.
- 3 Choose "Configure network drivers" and press Enter. If any drivers are already loaded, a list of them appears.
- 4 Choose "Select an additional driver" and press Enter. A list of drivers appears.
- 5 Insert the Intel floppy disk or compact disc and choose "Install an unlisted driver" by clicking Insert.
- 6 Specify the correct path to your media if necessary by pressing F3. Press Enter to search the floppy or compac disc.
- 7 The driver name is displayed: Intel (R) PRO/100+ Dual Port Server Adapter. Press Enter to select it.
- 8 The next screens ask for frame and protocol types. Use the arrow keys to select specific items or choose the defaults. Select "Save parameters and load driver" to continue.
- 9 To install an additional adapter or port, press the Esc key to go back to the Step 7 prompt "Select an adapter to install." Then, repeat steps 7-9 for each additional adapter or port you want to install.
- 10 To complete the driver installation process, go back to the Installation Options screen by pressing the Esc key until you see it.
- 11 Choose Exit to return to the server console prompt.



If the adapter cannot transmit or receive following the installation, you may need to modify the frame type in the AUTOEXEC.NCF file.

If you are installing multiple PRO/100+ adapters, repeat the driver installation process for each new adapter in the server.

# Windows 95



## Windows 95 Automatic Configuration

PCI servers automatically detect and configure PCI-compliant adapters while booting. The BIOS automatically sets the adapter IRQ level and I/O address each time you start your server.

Start your server to automatically configure the adapter. Resource configuration is complete when Windows 95 starts.

If your server displays an error while booting, it may require additional steps to configure. See the section *PCI Installation Tips* for more information.



## 1 Install Network Drivers from Disk

Have your Windows 95 installation compact disc or diskettes available, as Windows 95 prompts for them when you install the new adapter.

- 1 After you put the adapter in the server and connect the cables, start Windows 95.  
You'll see the New Hardware Found dialog box. *If this box does not appear and Windows 95 starts normally, you may need to manually add the adapter. See the MSWIN95.TXT file.*
- 2 Click "Driver from disk provided by hardware manufacturer," then click OK. You'll see the Install From Disk dialog box.
- 3 Insert the PRO/100+ Server adapter disk.
- 4 Specify D:\ (for compact disc) or A:\ (for floppy) as the path, then click OK.
- 5 Follow prompts for any Windows 95 installation disks and restart when prompted. (If you installed from the compact disc, the installation files are typically located at D:\Win95, where D is your CD-ROM drive.)

After restarting Windows 95, connect to your network by double-clicking the Network Neighborhood icon on the desktop.



## 2 Install PROSet Software (recommended)

PROSet is an enhanced utility you can use to easily configure and test your adapter in Windows 95 or Windows 98. To install PROSet:

- 1 Insert the PRO/100+ Server adapter disk in the disk drive.
- 2 From My Computer or the Windows Explorer, double-click the appropriate drive icon.
- 3 Click the PROSet icon or filename and click the right mouse button. From the menu that appears, click Install.
- 4 The PROSet files are copied to your hard disk.

- 5 To start PROSet, double-click the PROSet icon in the Control Panel:



- 6 The PROSet software examines your computer and displays this window or a similar one:

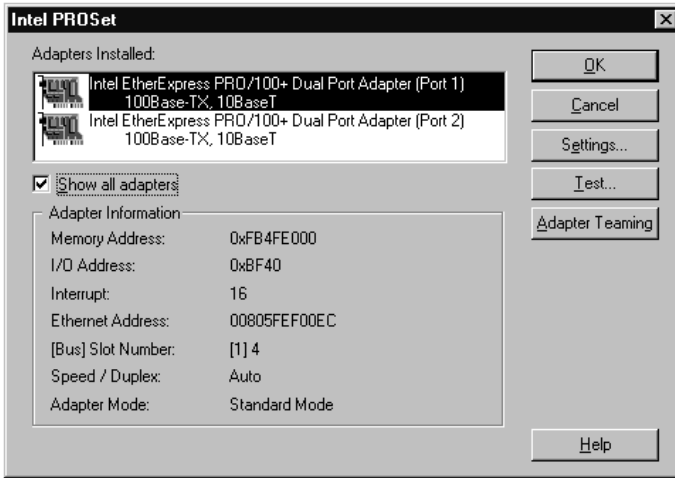

- 7 Click OK to exit PROSet and return to Windows.  
To set duplexing options, see *Select Duplex Mode*.



## Windows 95 Troubleshooting

If you can't connect to a server or if Windows 95 reports an error after you double-click Network Neighborhood, try the suggestions here first, then turn to the section *Troubleshooting and FAQs* if necessary.

- Make sure you're using the drivers that are on the drivers disk that ships with this adapter.
- Make sure the driver is loaded and the protocols are bound. Check the Device Properties list for trouble indicators (an X or ! symbol).
- Test each port of the adapter. Start PROSet, select a port, and click Test to run diagnostics.
- Check with your LAN administrator — you may need to install additional networking software.

# Windows 98



## Windows 98 Automatic Configuration

PCI servers automatically detect and configure PCI-compliant adapters while booting. The BIOS automatically sets the adapter IRQ level and I/O address each time you start your server.

Start your server to automatically configure the adapter. Resource configuration is complete when Windows 98 starts.

If your server displays an error while booting, it may require additional steps to configure. See *PCI Installation Tips* for more information.



## 1 Install Network Drivers from Disk

- 1 After you put the adapter in the server and connect the cables, start Windows 98. You'll see the New Hardware Found dialog box. *If this box does not appear and Windows 98 starts normally, you may need to manually add the adapter. See Manually Installing the Network Drivers in the section that follows.*
- 2 When prompted, insert the PRO/100+ Server adapter disk.
- 3 Specify D:\ (for CD) or A:\ (for floppy) as the path, then click OK.
- 4 Restart the system when prompted.  
To install PROSet software (recommended), refer to *Install PROSet Software* in the Windows 95 section.



## 2 Manually Installing the Network Drivers

- 1 After you put the adapter in the server and connect the cables, start Windows 98.
- 2 From the Control Panel, double-click the System icon.
- 3 Click the Device Manager tab.
- 4 Double-click Network Adapters in the list area.
- 5 Double-click one of the Intel PRO/100+ Dual Port Adapters.  
The Update Device Driver Wizard appears.
- 6 Select "Search for a better driver than the one your device is using now."  
Make sure the PRO/100+ Server adapter disk is in the drive, and click Next.
- 7 Select the appropriate drive and click Next.
- 8 Select "Choose the updated driver (Recommended)" and continue to click Next at each dialog until the driver files are copied.
- 9 When Windows has finished, click Close and restart your system.



It is important that you restart the system immediately after configuring *each* port.

- 10 Repeat these steps for the second port of the adapter. Then, see *Install PROSet Software* in the Windows 95 section.

# DOS and Windows 3.1 Setup for Novell NetWare Clients

## Important Note:

Windows 95, Windows 98 and Windows NT users: refer to the previous sections on Windows 95, Windows 98 and Windows NT. NetWare Client 32 users: refer to the NetWare readme files.

## DOS and Windows 3.1 Automatic Configuration

PCI computers automatically detect and configure PCI-compliant adapters while booting. The BIOS sets the adapter IRQ level and I/O memory address automatically each time you start your computer.

Start your computer to automatically configure the adapter. Resource configuration is complete when the DOS prompt appears. You can now continue with the procedure below.

If your computer displays an error while booting, it may require additional steps to configure a PCI adapter. See *PCI Installation Tips* for more information.

## Run Setup to Install Network Drivers

Setup can automatically install NetWare DOS ODI client drivers for you or display a readme file with installation instructions for other NOS drivers.

- 1 If your computer already has network drivers installed, restart the computer without loading them. If the drivers are loaded from the AUTOEXEC.BAT or CONFIG.SYS file, type REM in front of each line that loads a network driver. Or, with DOS 6.x or later press **F5** as DOS starts, to bypass the drivers.
- 2 Insert the PRO/100+ Server adapter disk in a drive, switch to that drive, and at the DOS prompt, type  
SETUP 
- 3 An adapter selection menu appears on the screen. Select the adapter you want by noting the Ethernet address. See *Installing Multiple Adapters* for more information on multiple adapters.
- 4 Select Automatic Setup from the Main menu. Then follow the instructions on the screen. (If you want to test the adapter with a responder on the network, see the next procedure.)

Setup displays the adapter's configuration and then runs a series of diagnostic tests that make sure the adapter and network are functioning properly. If Setup finds a problem, it displays the results and some possible solutions.

- 5 When Setup finishes the tests, you'll see the Install Network Drivers screen.
- 6 Select the driver you want to install. Setup can install a NetWare client driver for you. If you want to install other drivers, Setup displays a readme file with installation instructions.

To set duplexing options, see *Select Duplex Mode*.



## Troubleshooting

If you can't connect to a server, first try the suggestions here, then turn to the section *Troubleshooting and FAQs*.

- Make sure you're using the drivers for this adapter. The driver filename contains the letter B (for example, E100BODI.COM).
- If you're replacing an existing adapter, make sure the LINK statement in your NET.CFG is correct for the new adapter. For example, the LINK statement for a NetWare client is:  

```
LINK DRIVER E100BODI
```
- Verify that the frame type in your NET.CFG file matches your network.
- If setting up a server, check your LOAD and BIND statements.
- Test the adapter by running diagnostics in Setup. Additional testing is available by using a responder (see the next section).
- Check the readme files (see the inside front cover for instructions).

## Responder Testing on the Network (Optional)

Setup can test the adapter more thoroughly if there is a responder on the network while you run the tests.

- 1 Go to a computer on the network with a comparable PCI adapter installed.
- 2 Run the appropriate configuration program for the installed adapter and set it up as a responder.
- 3 Return to the server with the new adapter. Run Setup and test the adapter.

# NetWare Server 3.11, 3.12, Client 32, UNIX, OS/2, Banyan, and Other Operating Systems

Refer to the online documents. On a DOS server, view the appropriate readme file for information on installing your network driver.



To view the readme files, insert the PRO/100+ Server Adapter disk into a drive, switch to that drive, and type:

```
SETUP /README 
```

Refer to *Installing Adapter Drivers* for the operating system you need.

## Installing Multiple Adapters

**All users:** The adapter's 12-digit, hexadecimal Ethernet address is printed on a sticker placed on the adapter. The Ethernet address is sometimes called the node address or the MAC address. For dual port adapters, the Ethernet address printed on the identification sticker refers to the port closest to the PCI slot. Increment this address by one for the other port, furthest from the PCI slot. (For example, if the Ethernet address on the sticker reads 00A0C93F7F77, then the address of the port furthest from the PCI slot would be 00A0C93F7F78).

**NetWare users:** The server drivers use the PCI slot number to identify each installed port. You can correlate the PCI slot number to the port by using the Ethernet address that is printed on a label on the adapter. Run Setup from the Intel disk to view the Ethernet address and slot number for each port. For more information, see the readme files. NetWare 4.11 server installations use unique slot numbers that are assigned during server setup.

**Windows 95 users:** Repeat the configuration procedure for each adapter you want to install.

**Windows 98 users:** You must restart your system after installing each adapter port. For example, in configuring a dual port adapter, you will restart twice (once for each port).

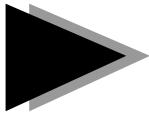

## Select Duplex Mode (Optional)

Duplexing is a performance option that lets you choose how the adapter sends and receives data packets over the network. The adapter can operate at full duplex only when connected to a full duplex 10BASE-T, 100BASE-TX switch, or to another full duplex adapter.

- **Auto (requires a full duplex adapter or switch with auto-negotiation capability).** The adapter negotiates with the switch to send and receive packets at the highest rate. This is the default setting. If the switch does not provide auto-negotiation, the adapter runs at half duplex.
- **Full duplex (requires a full duplex switch or adapter).** The adapter can send and receive packets at the same time. This mode can increase adapter performance capability. If the full duplex switch provides auto-negotiation, the adapter runs at full duplex. If the full duplex switch does not provide auto-negotiation, you need to set the adapter duplex mode manually (see following paragraphs), because it defaults to half duplex.
- **Half duplex.** The adapter performs one operation at a time; it either sends or receives.



If an adapter port is running at 100 Mbps and half duplex, your potential bandwidth is higher than if you run it at 10 Mbps and full duplex.

### Manually Configuring for Full Duplex

If your switch supports auto-negotiation with the N-way standard, duplex configuration is automatic and no action is required on your part. However, few switches in the current installed base support auto-negotiation. Check with your network system administrator to verify whether your switch supports this feature. Most installations will require manual configuration to change to full duplex.

Configuration is specific to the driver you're loading for your network operating system (NOS).

To set up the duplex mode, refer to the section below that corresponds to your operating system.



Adapter performance may suffer or your adapter may not operate if your switch doesn't support full duplex and you configure the adapter to full duplex. Make sure you always set the speed when you configure duplex.



## ***Setting Full Duplex in DOS, ODI\*, NDIS 2.01 Clients***

For each port or adapter, edit the NET.CFG or PROTOCOL.INI file. Add these keywords to the Link Driver section:

```
FORCEDUPLEX 2  
SPEED 100 (or 10 if 10BASE-T)
```

## ***Setting Full Duplex in NetWare Server***

For each port or adapter, in AUTOEXEC.NCF, load E100B.LAN and add the following statement (you must include the equal sign for servers):

```
FORCEDUPLEX=2 SPEED=100  
(or 10 if 10BASE-T)
```

For more information, see the readme file for NetWare servers.

## ***Setting Full Duplex in Windows NT, Windows 95, and Windows 98***

While running Windows NT, Windows 95, or Windows 98:

- 1 From the Control Panel, double-click the PROSet icon.
- 2 Click on Settings.
- 3 In the Network Speed list box, select 10 or 100, according to the speed of your network.
- 4 In the Duplex Mode list box, select Full.
- 5 Click OK.
- 6 Restart Windows.

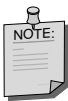

PROSet does not install automatically under Windows 95 or Windows 98 during the network driver installation. You must manually install PROSet before you perform the previous steps. See *Install PROSet Software* in the Windows 95 section.

## ***Setting Full Duplex in Other Operating Systems***

See the *Adapter Installation and Special Configurations* readme file. Instructions for viewing readme files are at the front of this book.



# Choose Adapter Teaming Options

The PRO/100+ Server adapter provides several options for increasing throughput and fault tolerance when running Windows NT 4.0 or NetWare 4.1x. For a table listing the protocols compatible with each teaming option, see the section *Teaming Options Supported by OS and Protocol*.



The terms “adapter” and “port” are used interchangeably throughout the Adapter Teaming sections that follow. Each port of a dual port adapter appears as an independent adapter within the Adapter Teaming Configuration dialog box.

**Adapter Fault Tolerance (AFT)** — provides automatic redundancy for your adapter. If the primary adapter fails, the secondary takes over. Adapter Fault Tolerance supports up to four adapter teams, with two to four adapters per team.

**Adaptive Load Balancing (ALB)** — increases transmission throughput by supporting up to four adapter teams, with two to four adapters per team. Also includes the AFT option. Works with any 100BASE-TX switch.

**Fast EtherChannel (FEC)** — increases transmission and reception throughput by supporting up to two adapter teams, with two or four adapters per team. Also includes the AFT option. Requires a Cisco switch with FEC capability or an HP ProCurve Switch 8000M/1600M.



For information on associating a NIC listing with its physical port, see the section *Associating a NIC Listing with its Physical Port*.

## General configuration Notes

- Adapter Teaming options are supported by Windows NT versions 4.0 and later, or NetWare 4.1x.
- Adapter Teaming options require NT 4.0 with Service Pack 3.0 and the NDIS driver hotfix from Microsoft. See the *Late Breaking News* for details.

## Setting Up Adapter Fault Tolerance Only



Use this procedure to set up Adapter Fault Tolerance only. If setting up Adaptive Load Balancing or Fast EtherChannel\*, use the procedures in the next sections since Adapter Fault Tolerance is automatically added when you select those options.

Adapter Fault Tolerance (AFT) provides the safety of an additional backup link between the server and hub or switch. In the case of failure in a hub or switch port, cable, or adapter, you can maintain uninterrupted network performance.

Adapter Fault Tolerance is implemented with a primary adapter and a backup (or secondary) adapter. During normal operation, the backup adapter will have transmit disabled. If the link to the primary adapter fails, the link to the secondary adapter automatically takes over.

To use AFT, your adapters must be installed in a Windows NT 4.0 or NetWare 4.1x server and they must be linked to the same network.

## Setting Up Adapter Fault Tolerance in Windows NT 4.0

- 1 Double-click the Network icon in the Control Panel.
- 2 On the Adapters tab, select an adapter that will be in the team and click Properties. (Each port of a PRO/100+ Dual Port Server adapter appears as an independent adapter in the Adapter tab.)
- 3 Click Adapter Teaming in the PROSet window.
- 4 Click OK when prompted. You'll see the Adapter Teaming Configuration window.
- 5 Follow the instructions for assigning adapters to a team.
- 6 Select AFT Only in the Team Function area.
- 7 Click OK and then click Close to finish. When prompted, restart your server.

## Deleting a Team

- 1 Double-click the Network icon in the Control Panel.
- 2 On the Adapters tab, select the AFT team to delete.
- 3 Click Remove. You'll see a confirmation dialog. Click Yes.
- 4 Click Close. Restart when prompted.

## Setting Up Adapter Fault Tolerance in NetWare

- 1 Copy the following lines from the EXAMPLES.TXT file (on the PRO/100+ Server Adapter disk) and paste them into the appropriate file. These commands assume the AFT.NLM and E100B.LAN files are in the system directory (SYS\SYSTEM) of your server. (Files must be copied from the PRO/100+ Server Adapter disk to your server's hard drive.)



Adapter Fault Tolerance must be loaded before the PRO/100+ Server adapter driver, E100B.LAN, or any other LAN driver.

### Copy these lines into the AUTOEXEC.NCF file

```
;- Load Adapter Fault Tolerance
load aft

;- Load LAN driver on 1st adapter
load e100b slot=7 frame=ethernet_802.2 name=pri_802.2

;- Load LAN driver on 2nd adapter
load e100b slot=8 frame=ethernet_802.2 name=sec_802.2

;- Bind ipx to 1st adapter. Note: do not bind protocols
;- to 2nd adapter
bind ipx pri_802.2 net=2

;- Set the 2nd adapter to be a Fault Tolerance Partner
;- to the 1st adapter
aft bind 7 8
```

Where:

slot= the slot in which your PRO/100+ Server adapter is installed, such as 7. If you don't know the number, load the driver without it. NetWare will prompt you with supported PCI slot numbers.

frame= the frame type of the network segment the server is on.

7 is the primary adapter's slot number.

8 is the secondary adapter's slot number.

- 2 Modify the lines to match your server's requirements.
- 3 Save the AUTOEXEC.NCF file and restart your server.

## Deleting a Team

To remove a team in AFT, ALB or FEC mode, comment out the lines above and restart the server.

## Setting Up Adaptive Load Balancing

Adaptive Load Balancing (ALB) is a simple and efficient way to increase your server's transmit throughput. With ALB you group PRO/100+ Server adapters in teams to provide an increased transmit rate (up to 400 Mbps) using a maximum of four adapters. The ALB software continuously analyzes transmit loading on each adapter and balances the rate across the adapters as needed. Adapter teams configured for ALB also provide the benefits of AFT. Receive rates remain at 100 Mbps.



For maximum benefit, ALB should not be used under NetBEUI and some IPX\* environments. For a list of specific IPX environments supported, see *Teaming Options Supported by OS and Protocol*.

To use ALB, your adapters must be configured as a team in your server and be linked to the same network switch.

## Setting Up ALB in Windows NT 4.0

- 1 Double-click the Network icon in the Control Panel.
- 2 On the Adapters tab, select an adapter that will be in the team and click Properties.
- 3 Click Adapter Teaming in the PROSet window.
- 4 Click OK when prompted. You'll see the Adapter Teaming Configuration window.
- 5 Follow the instructions to assign adapters to a team.
- 6 Select Load Balancing in the Team Function area.
- 7 Click OK and then click Close to finish. When prompted, restart your server.

## Deleting a Team

- 1 Double-click the Network icon in the Control Panel.
- 2 On the Adapters tab, select the ALB team to delete.
- 3 Click Remove. You'll see a confirmation dialog. Click Yes.
- 4 Click Close. Restart when prompted.

## Setting Up ALB in NetWare

- 1 Copy the following lines from the EXAMPLES.TXT file (on the PRO/100+ Server adapter disk) and paste them into the appropriate file. These commands assume the AFT.NLM and E100B.LAN files are in the system directory (SYS\SYSTEM) of your server. (Files must be copied from the PRO/100+ Server adapter disk to your server's hard drive).



Adaptive Load Balancing must be loaded before the PRO/100+ Server adapter driver, E100B.LAN, or any other LAN driver.

### Copy these lines into the AUTOEXEC.NCF file

```
;- Load Adaptive Load Balancing
load aft

;- Load LAN driver on 1st adapter
load e100b slot=7 frame=ethernet_802.2 name=pri_802.2

;- Load LAN driver on 2nd adapter
load e100b slot=8 frame=ethernet_802.2 name=sec_802.2

;- Bind ipx to 1st adapter
bind ipx pri_802.2 net=2
```

```
;- Set the 2nd adapter to be a Load Balancing Partner to  
;- the 1st adapter  
aft balance 7 8
```

Where:

slot= the slot your PRO/100+ Server adapter is installed in, such as 7.  
If you don't know the number, load the driver without it. NetWare will prompt you with available PCI device numbers.

frame= the frame type of the network segment the server is on.

7 is the primary adapter's slot number.

8 is the secondary adapter's slot number.

- 2 Modify the lines to match your server's requirements.
- 3 Save the AUTOEXEC.NCF file and restart your server.

## Deleting a Team

To remove a team in AFT, ALB or FEC mode, comment out the lines above and restart the server.

## Setting Up Fast EtherChannel

Fast EtherChannel (FEC) is a performance technology developed by Cisco to increase your server's throughput.

Unlike ALB, you can configure FEC to increase both transmission **and** reception channels between your server and switch. FEC works with FEC-enabled Cisco switches, such as the Catalyst\* 5000 series. It also works with the HP PROCurve Switch 8000M/1600M.

With FEC, as you add adapters to your server, you can group them in teams to provide up to 800 Mbps at full duplex, with a maximum of four PRO/100+ Server adapters. The FEC software continuously analyzes loading on each adapter and balances network traffic across the adapters as needed. Adapter teams configured for FEC also provide the benefits of AFT.



For maximum benefit, FEC should be used only under TCP/IP environments. Do NOT specify Fast EtherChannel (FEC) as a teaming option unless you are sure the PRO/100+ Server adapters which are to comprise the team are connected to ports configured for FEC mode, and that these ports are linked to the same FEC-compatible Cisco switch. Misconfiguration can cause severe performance degradation.

To use FEC, your adapters must be configured as a team in your server. The adapters must also be linked to the same supported switch, using ports on the switch that are adjacent to one another.

## Setting Up FEC in Windows NT 4.0

- 1 Double-click the Network icon in the Control Panel.
- 2 On the Adapters tab, select an adapter that will be in the team and click Properties.
- 3 Click Adapter Teaming in the PROSet window.
- 4 Click OK when prompted. You'll see the Adapter Teaming Configuration window.
- 5 Follow the instructions for assigning adapters to a team.
- 6 Select Fast EtherChannel in the Team Function area.
- 7 Click OK and then click Close to finish. When prompted, restart your server.

## Deleting a Team

- 1 Double-click the Network icon in the Control Panel.
- 2 On the Adapters tab, select the FEC team to delete.
- 3 Click Remove. You'll see a confirmation dialog. Click Yes.
- 4 Click Close. Restart when prompted.

## Setting Up FEC in NetWare

- 1 Copy the following lines from the EXAMPLES.TXT file (on the PRO/100+ Server adapter disk) and paste them into the appropriate file. These commands assume the AFT.NLM and E100B.LAN files are in the system directory (SYS\SYSTEM) of your server. (Files must be copied from the PRO/100+ Server adapter disk to your server's hard drive).



Fast EtherChannel must be loaded before the PRO/100+ Server adapter driver, E100B.LAN, or any other LAN driver.

### Copy these lines into the AUTOEXEC.NCF file

```
;- Load Fast EtherChannel
load aft

;- Load LAN driver on 1st adapter
load e100b slot=7 frame=ethernet_802.2 name=pri_802.2

;- Load LAN driver on 2nd adapter
load e100b slot=8 frame=ethernet_802.2 name=sec_802.2

;- Bind ipx to 1st adapter
bind ipx pri_802.2 net=2

;- Set the 2nd adapter to be a Fast EtherChannel Partner to
;- the 1st adapter
aft fec 7 8
```

Where:

`slot`= the slot in which your PRO/100+ Server adapter is installed, such as 7. If you don't know the number, load the driver without it. NetWare will prompt you with available PCI device numbers.

`frame`= the frame type of the network segment the server is on.

7 is the primary adapter's slot number.

8 is the secondary adapter's slot number.

- 2 Modify the lines to match your server's requirements.
- 3 Save the AUTOEXEC.NCF file and restart your server.

### Deleting a Team

To remove team in AFT, ALB or FEC mode, comment out the lines above and restart the server.

## Teaming Options Supported by OS and Protocol

	Windows NT 4.0	NetWare 4.11
AFT	IP, NetBEUI, IPX(NCP), IPX (NetBIOS)	IP, IPX (NCP)
ALB	IP, IPX (NCP)	IP, IPX (NCP)
FEC	IP, NetBEUI, IPX(NCP), IPX (NetBIOS)	IP, IPX (NCP)

Note that only IPX packets type NCP (Netware Core Protocol) are load balanced. Under FEC, all protocols can be load balanced.



# Using the Adapter Teaming Configuration Dialog Box

In PROSet, you can use the Adapter Teaming Configuration dialog box to specify teaming for your PRO/100+ Server adapters. This section shows you how to associate each adapter listing in the Adapter Teaming Configuration dialog box with its physical port in the adapter card.



These instructions assume that you know the Ethernet address for each port of your PRO/100+ Server adapter(s). If not, see Step 3 in the section *Put the Adapter(s) in the Server*.

## Associating an Adapter Listing with its Physical Port

- 1 Double-click the Network icon in the Control Panel.
- 2 On the Adapters tab, select a PRO/100+ Server adapter that is among those you want to identify and click Properties.
- 3 Click Adapter Teaming in the PROSet window.
- 4 Click OK when prompted. You'll see the Adapter Teaming Configuration window which lists each of the PRO/100+ Server adapter ports available in your server.
- 5 Select an adapter and click Properties.  
You'll see the Adapter Information dialog box, listing the adapter's Ethernet address in the Permanent Network Address field.
- 6 Click Close and repeat steps 5 and 6 to identify each of your adapter ports.

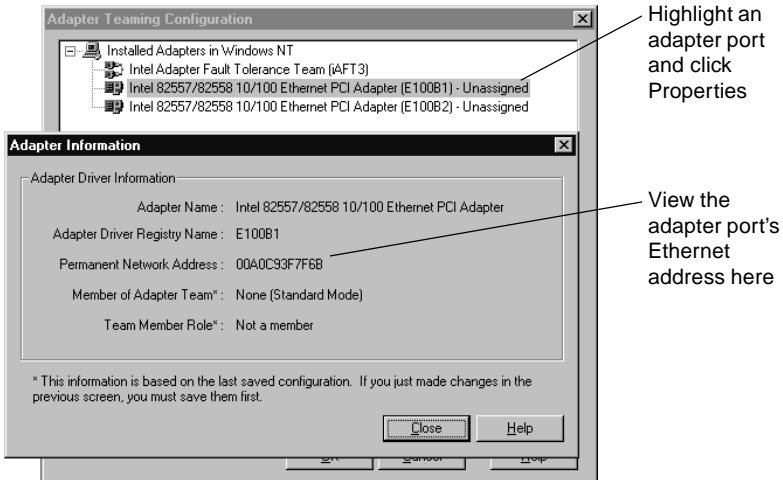

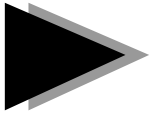

# Troubleshooting and FAQs

## If the Adapter Can't Connect to the Network

### Make sure the cable is installed properly.

The network cable must be securely attached at both RJ-45 connections (adapter and hub). The maximum allowable distance from adapter to hub is 100 meters. If the cable is attached and the distance is within acceptable limits but the problem persists, try a different cable.

If you're directly connecting two servers (no hub), use a crossover cable.

See the *Cabling* readme file for more information on crossover cables.

### Check the LED lights on the adapter.

The adapter has three diagnostic LEDs above each cable connector. These lights help indicate if there's a problem with the connector, cable, or switch/hub. The table on the next page describes the LEDs.

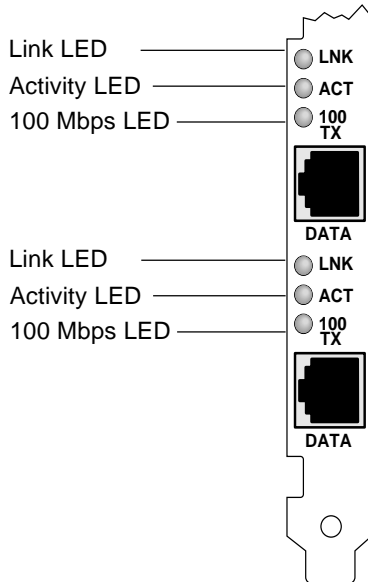

LED	Indication	Meaning
LNK	On	The adapter and switch are receiving power; the cable connection between the switch and adapter is good.
	Off	The adapter and switch are not receiving power; the cable connection between the switch and adapter is faulty; or you have a driver configuration problem.
ACT	On or flashing	The adapter is sending or receiving network data. The frequency of the flashes varies with the amount of network traffic.
	Off	The adapter is not sending or receiving network data.
100	On	Operating at 100 Mbps.
	Off	Operating at 10 Mbps.

### **Make sure you're using the correct drivers.**

Make sure you're using the drivers that come with this adapter. The driver file name contains the letter B (for example, E100BODI.DOS). Drivers that support previous versions of this adapter don't support this version of the adapter.

### **Make sure the switch port and the adapter have the same duplex setting.**

If you configured the adapter for full duplex, make sure the switch port is also configured for full duplex. Setting the wrong duplex mode can degrade performance, cause data loss, or result in lost connections.

## **Testing the Adapter (Diagnostics)**

Test the adapter by running diagnostics. For DOS or Windows 3.1, run Setup on the PRO/100+ Server adapter disk. For Windows NT and Windows 95 run PROSet by double-clicking the PROSet icon in the Control Panel. Click Help from the main PROSet window to get complete diagnostics information and instructions.

## Viewing the Status of an Adapter in Event Viewer

If an adapter in a team should fail, an event record is generated in an Event Viewer log. You can use the log to determine which adapter failed. To do so, double-click on an entry in the Event Viewer, then view the last three octets of the adapter's Ethernet address as shown below. In this particular example, the last three octets are 3f7f6b.

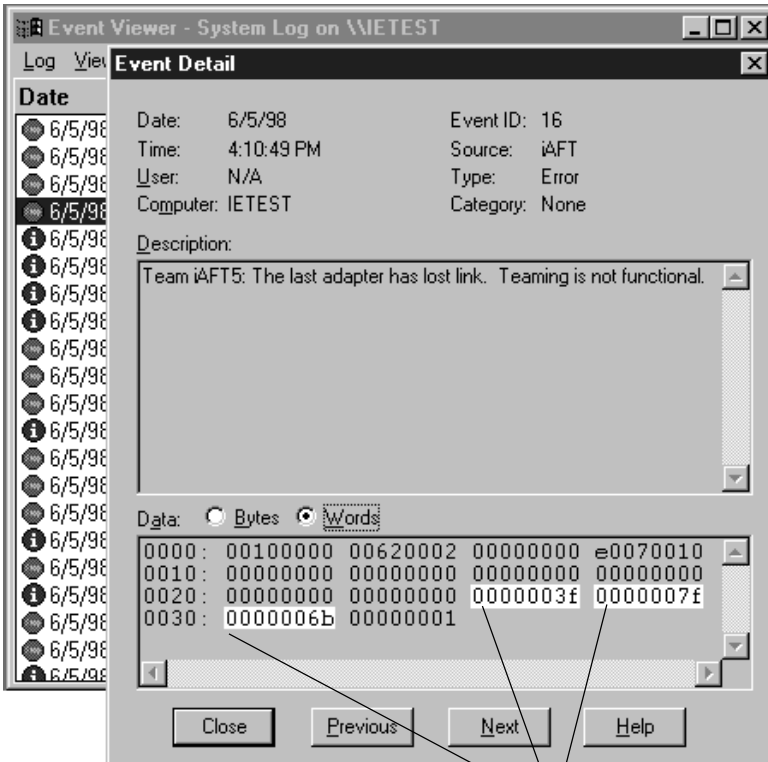

The last three octets of the adapter's Ethernet address are listed here, at the bottom of the scrollable text

## Frequently Asked Questions (FAQs)

### **SETUP.EXE reports the adapter is “Not enabled by BIOS”.**

- The PCI BIOS isn't configuring the adapter correctly. Try the section *PCI Installation Tips*.

### **The server hangs when the drivers are loaded.**

- Change the PCI BIOS interrupt settings. See *Technical Information* in the next section for PCI installation tips.
- If you are using EMM386, it must be version 4.49 or newer (this version ships with MS-DOS\* 6.22 or newer).

### **Diagnostics pass, but the connection fails or errors occur.**

- At 100 Mbps use Category 5 wiring and make sure the network cable is securely attached.
- For NetWare, make sure you specify the correct frame type in your NET.CFG file.
- Make sure the duplex mode setting on the adapter matches the setting on the switch.
- At 100 Mbps, connect to a 100BASE-TX hub/switch (not 100BASE-T4).

### **The LNK LED doesn't light.**

- Make sure you've loaded the network drivers.
- Check all connections at the adapter and the switch.
- Try another port on the switch.
- Make sure the duplex mode setting on the adapter matches the setting on the switch.
- Make sure you have the correct type of cable between the adapter and the hub. 100 BASE-TX requires two pairs. Some hubs require a crossover cable while others require a straight-through cable. See the *Cabling* readme file for more information on cabling.

### **The ACT LED doesn't light.**

- Make sure you've loaded the correct network drivers.
- The network may be idle. Try accessing a server.
- The adapter isn't transmitting or receiving data. Try another adapter.
- Make sure you're using two-pair cable for TX wiring.

### **The adapter stopped working when another adapter was added to the server.**

- Make sure the cable is connected to the adapter.
- Make sure your PCI BIOS is current. See *PCI Installation Tips*.
- Make sure the other adapter supports shared interrupts. Also, make sure your operating system supports shared interrupts — OS/2 doesn't.
- Try reseating the most recently installed adapter.

### The adapter stopped working without apparent cause.

- Run the diagnostics.
- Try reseating the adapter first, then try a different slot if necessary.
- The network driver files may be corrupt or deleted. Delete and then reinstall the drivers.

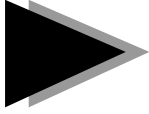

## Technical Information

### PCI Installation Tips

PCI computers are designed to automatically configure add-in cards each time the server starts. Your PCI server sets the I/O address and IRQ level for your network adapter when the server starts. These values cannot be changed by Intel adapter software. If you experience a problem when the server starts, additional configuration steps may be required.

On these computers, manual configuration is possible through the computer's PCI BIOS setup utility. Refer to your computer's documentation. You may need to verify or change some BIOS settings.

Some common PCI solutions are listed here.

- **Busmaster-enabled slots.** On some computers, all slots are not busmaster enabled by default. Check your BIOS PCI bus setting. It will be set to either Busmaster or Non-busmastered. Choose Busmaster.
- **Reserve interrupts (IRQs) and/or memory addresses for ISA adapters.** This prevents PCI cards from trying to use the same settings ISA cards are using. Check your PCI BIOS setup program. There may be IRQ options such as Enable for ISA, Reserve for ISA, or Disable for PCI. This option is sometimes in the Plug and Play area of the BIOS setup.
- **Enable the PCI slot.** In some PCI computers, you must use the PCI BIOS setup program to enable the PCI slot. This is especially common in PCI computers with the PhoenixBIOS\*.
- **Update your PCI BIOS.** An updated PCI system BIOS can correct some PCI configuration problems. Call your server manufacturer to see if an updated BIOS version is available for your server. Phone numbers for the top PCI server manufacturers are listed in the *PCI Installation* readme file on the PRO/100+ Server adapter disk.

- **Configure the slot for level-triggered interrupts.** The slot the adapter is using must be configured for level-triggered interrupts rather than edge-triggered interrupts. Check your PCI BIOS Setup program.

Here are some examples of PCI BIOS setup program parameters:

PCI slot #:	<i>Slot where the adapter is installed</i>
Master:	ENABLED
Slave:	ENABLED
Latency timer:	40
Interrupt:	<i>Choose an IRQ from the list</i>
Edge-level:	Level

The exact wording of these parameters varies with different computers.

## “Push” Installation for Windows 95

If you are a LAN Administrator setting up server-based push installation of Windows 95 as defined in Microsoft Windows 95 Resource Kit, additional steps are required for this adapter. Refer to the *Push Installation for Windows 95* readme file on the support Web site (see the inside back cover).

## Fast Ethernet Wiring

**100BASE-TX Specification:** The 100BASE-TX specification supports 100 Mbps transmission over two pairs of Category 5 twisted-pair Ethernet (TPE) wiring. One pair is for transmit operations and the other for receive operations. Segment lengths are limited to 100 meters with 100BASE-TX for signal timing reasons. This complies with the EIA 568 wiring standard.

## Fast Ethernet Hubs and Switches

The two basic types of hubs are shared hubs (hubs) and switching hubs (switches). This adapter can be used with either type of hub for 10 Mbps. At 100 Mbps, a TX hub or switch is required.

### Shared Hubs

In a shared network environment, computers are connected to hubs called repeaters. All ports of the repeater hub share a fixed amount of bandwidth, or data capacity. On a 100 Mbps shared hub, all nodes on the hub must share the 100 Mbps of bandwidth. As stations are added to the hub, the effective bandwidth available to any individual station gets smaller. Shared hubs do not support full duplex.

On a shared hub all nodes must operate at the same speed, either 10 Mbps or 100 Mbps. Fast Ethernet repeaters provide 100 Mbps of available bandwidth, ten times more than what’s available with a 10BASE-T repeater.

## Switching Hubs

In a switched network environment, each port gets a fixed, dedicated amount of bandwidth. If a new user is added to a 100 Mbps switch, the new station receives its own dedicated 100 Mbps link and doesn't impact the 100 Mbps bandwidth of another station. Switches can effectively increase the overall bandwidth available on the network, significantly improving performance. Switches can also support full duplex.

**For more information on Fast Ethernet, visit our Network Products web site at <http://www.intel.com/network>.**

## Adapter Specifications

Compatibility	PCI systems
Media (cable) Connectors and Wiring	RJ45 Use Category 5 cabling at 100 Mbps Supports 100BASE TX Fast Ethernet standard
Data Rate Mode	10 or 100 Mbps
Interrupt Levels	PCI: INTA, INTB
SRAM Transmit/Receive Buffer	6 Kbytes per port
Power Requirements	6.5 Watts @ +5VDC
Isolation Voltage	200V RMS
Operating Temperature	0 - 55 degrees C
Humidity	10% - 90% non-condensing
Diagnostic LEDs	Activity and Link 100 Mbps
Diagnostic Software	On-board On-network Responder
Compliance & Certification	1. Safety -- UL 2. FCC Class B 3. CE & Immunity



# Network Software License Agreement

PLEASE REVIEW THE LICENSE AGREEMENT BELOW. BY OPENING THIS SOFTWARE OR PACKAGE OR OTHERWISE DOWNLOADING OR COPYING THIS SOFTWARE, YOU ARE AGREEING TO BE BOUND BY THE TERMS OF THIS AGREEMENT. DO NOT USE THIS SOFTWARE UNTIL YOU HAVE CAREFULLY READ AND AGREED TO THE FOLLOWING TERMS AND CONDITIONS. IF YOU DO NOT AGREE TO THE TERMS OF THIS AGREEMENT, DO NOT INSTALL OR USE THIS SOFTWARE.

LICENSE: Intel Corporation ("Intel") grants you the non-exclusive right to use the enclosed software program (the "Software") but only in conjunction with, at a minimum, one Intel PRO/100+ Dual Port Server Adapter. You may not use, copy, modify, rent, sell or transfer the Software or any portion thereof excepts as provided in this Agreement.

You may:

1. Install and use the Software on one or more personal computers and/or local area network ("LAN") servers;
2. Copy the Software only for the purposes of installing and using the Software on personal computers and/or LAN servers as described above, and for backup or archival purposes.

RESTRICTIONS:

You Will Not:

1. Sublicense the Software;
2. Reverse engineer, decompile, or disassemble the Software;
3. Copy the Software, in whole or in part, except as provided in this Agreement.

TRANSFER: You may transfer the Software to another party if the receiving party agrees to the terms of this Agreement and you retain no copies of the Software and accompanying documentation. Transfer of the Software terminates your right to use the Software.

OWNERSHIP AND COPYRIGHT OF SOFTWARE: Title to the Software and all copies thereof remain with Intel or its suppliers. The Software is copyrighted and is protected by United States and other countries, and international treaty provisions. You will not remove the copyright notice from the Software. You agree to prevent any unauthorized copying of the Software. Intel may make changes to the Software, or to items referenced therein, at any time without notice, but is not obligate to support or update the Software. Except as otherwise provided, Intel grants no express or implied right under Intel patents, copyrights, trademarks, or other intellectual property rights.

LIMITED MEDIA WARRANTY: Intel warrants that the media on which the Software is furnished will be free from defects in material and workmanship for a period of one (1) year from the date of purchase. Upon return of such defective media, Intel's entire liability and your exclusive remedy shall be the replacement of the Software.

Exclusions of other warranties: THE SOFTWARE IS PROVIDED "AS IS" WITHOUT WARRANTIES OF ANY KIND, EITHER EXPRESS OR IMPLIED, INCLUDING WARRANTIES OF NON-INFRINGEMENT OF INTELLECTUAL PROPERTY, MERCHANTABILITY, OR FITNESS FOR ANY PARTICULAR PURPOSE. Intel does not warrant or assume responsibility for the accuracy or completeness of any information, text, graphics, links, or other items contained within the Software.

LIMITATION OF LIABILITY: IN NO EVENT SHALL INTEL HAVE ANY LIABILITY FOR ANY INDIRECT OR SPECULATIVE DAMAGES WHATSOEVER (INCLUDING, WITHOUT LIMITING THE FOREGOING, CONSEQUENTIAL, INCIDENTAL, AND SPECIAL DAMAGES) INCLUDING, BUT NOT LIMITED TO, INFRINGEMENT OF INTELLECTUAL PROPERTY, REPROCUREMENT COSTS, LOSS OF USE, BUSINESS INTERRUPTIONS, AND LOSS OF PROFITS, IRRESPECTIVE OF WHETHER INTEL HAS ADVANCE NOTICE OF THE POSSIBILITY OF ANY SUCH DAMAGES. SOME JURISDICTIONS PROHIBIT EXCLUSION OR LIMITATION OF LIABILITY FOR IMPLIED WARRANTIES OR CONSEQUENTIAL OR INCIDENTAL DAMAGES, SO THE ABOVE LIMITATION MAY NOT APPLY TO YOU. YOU MAY ALSO HAVE OTHER LEGAL RIGHTS THAT VARY FROM JURISDICTION TO JURISDICTION.

AUDIT: Intel reserves the right to have audits conducted to verify your compliance with this Agreement.

TERMINATION OF THIS LICENSE: Intel may terminate this license at any time if you are in breach of any of its terms and conditions. Upon termination, you will immediately destroy the Software and documentation or return all copies of the Software and documentation to Intel.

U.S. GOVERNMENT RESTRICTED RIGHTS: The Software and documentation were developed at private expense and are provided with "RESTRICTED RIGHTS." Use, duplication, or disclosure by the Government is subject to restrictions as set forth in FAR 52.227-14 and DFAR 252.227-7013 et seq. or its successor. Use of the software by the Government constitutes acknowledgment of Intel's proprietary rights therein. Contractor or Manufacturer is Intel Corporation, 2200 Mission College Blvd., Santa Clara, CA 95052.

EXPORT LAWS: You agree that the distribution and export/re-export of the Software is in compliance with the laws, regulations, orders or other restrictions of the U.S. Export Administration Regulations. Some products may contain encryption technology. U.S. Department of Commerce Encryption Regulations are applicable on all products imported to and exported from the United States and Puerto Rico. Additionally, imports and exports may be regulated by government agencies in other countries. Intra-country restrictions may be applicable regarding application use. You agree that the distribution and import, export, and /re-export of the Software is in compliance with all applicable laws, regulations, orders or other restrictions on encryption technology.

GOVERNING LAW: Claims arising under this Agreement shall be governed by the laws of California, excluding its principles of conflict of laws and the United Nations Convention on Contracts for the Sale of Goods. Intel is not obligated under any other agreements unless they are in writing and signed by an authorized representative of Intel.

SEVERABILITY: The terms and conditions stated in this Agreement are declared to be severable. If any paragraph, provisions, or clause in this Agreement shall be found or be held to be invalid or unenforceable in any jurisdiction in which this Agreement is being performed, the remainder of this Agreement shall be valid and enforceable and the parties shall use good faith to negotiate a substitute, valid, and enforceable provision which most nearly effects the parties' intent in entering into this Agreement.

# Limited Lifetime Hardware Warranty

Intel warrants to the original owner that the adapter product delivered in this package will be free from defects in material and workmanship. This warranty does not cover the adapter product if it is damaged in the process of being installed or improperly used.

THE ABOVE WARRANTY IS IN LIEU OF ANY OTHER WARRANTY, WHETHER EXPRESS, IMPLIED OR STATUTORY, INCLUDING BUT NOT LIMITED TO ANY WARRANTY OF NONINFRINGEMENT OF INTELLECTUAL PROPERTY, MERCHANTABILITY, FITNESS FOR A PARTICULAR PURPOSE ARISING OUT OF ANY PROPOSAL, SPECIFICATION, OR SAMPLE.

This warranty does not cover replacement of adapter products damaged by abuse, accident, misuse, neglect, alteration, repair, disaster, improper installation, or improper testing. If the adapter product is found to be defective, Intel, at its option, will replace or repair the hardware product at no charge except as set forth below, or refund your purchase price provided that you deliver the adapter product along with a Return Material Authorization (RMA) number (see below), along with proof of purchase (if not registered), either to the dealer from whom you purchased it or to Intel with an explanation of any deficiency. If you ship the adapter product, you must assume the risk of damage or loss in transit. You must use the original container (or the equivalent) and pay the shipping charge.

Intel may replace or repair the adapter product with either new or reconditioned parts, and any adapter product, or part thereof replaced by Intel becomes Intel's property. Repaired or replaced adapter products will be returned to you at the same revision level as received or higher, at Intel's option. Intel reserves the right to replace discontinued adapter products with an equivalent current generation adapter product.

## Returning a defective product

From North America:

Before returning any adapter product, contact Intel Customer Support and obtain a Return Material Authorization (RMA) number by calling +1 916-377-7000.

If the Customer Support Group verifies that the adapter product is defective, they will have the RMA department issue you an RMA number to place on the outer package of the adapter product. Intel cannot accept any product without an RMA number on the package.

All other locations:

Return the adapter product to the place of purchase for a refund or replacement.

INTEL ADAPTER MONEY-BACK GUARANTEE (North America Only)

Intel wants you to be completely satisfied with the Intel adapter product that you have purchased. Any time within ninety (90) days of purchase, you may return your Intel adapter to the original place of purchase for a full refund of the purchase price from your dealer. Resellers and distributors, respectively, accepting returns and refunding money back to their customers may return Intel adapters to their original place of purchase. Intel guarantees that it will accept returns under this policy and refund the original purchase price to customers purchasing directly from Intel.

## Limitation of Liability and Remedies

INTEL'S SOLE LIABILITY HEREUNDER SHALL BE LIMITED TO DIRECT, OBJECTIVELY MEASURABLE DAMAGES. IN NO EVENT SHALL INTEL HAVE ANY LIABILITY FOR ANY INDIRECT OR SPECULATIVE DAMAGES (INCLUDING, WITHOUT LIMITING THE FOREGOING, CONSEQUENTIAL, INCIDENTAL, AND SPECIAL DAMAGES) INCLUDING, BUT NOT LIMITED TO, INFRINGEMENT OF INTELLECTUAL PROPERTY, RECUREMENT COSTS, LOSS OF USE, BUSINESS INTERRUPTIONS, LOSS OF GOODWILL, AND LOSS OF PROFITS, WHETHER ANY SUCH DAMAGES ARISE OUT OF CONTRACT NEGLIGENCE, TORT, OR UNDER ANY WARRANTY, IRRESPECTIVE OF WHETHER INTEL HAS ADVANCE NOTICE OF THE POSSIBILITY OF ANY SUCH DAMAGES. NOTWITHSTANDING THE FOREGOING, INTEL'S TOTAL LIABILITY FOR ALL CLAIMS UNDER THIS AGREEMENT SHALL NOT EXCEED THE PRICE PAID FOR THE PRODUCT. THESE LIMITATIONS ON POTENTIAL LIABILITIES WERE AN ESSENTIAL ELEMENT IN SETTING THE PRODUCT PRICE. INTEL NEITHER ASSUMES NOR AUTHORIZES ANYONE TO ASSUME FOR IT ANY OTHER LIABILITIES.

Some states do not allow the exclusion or limitation of incidental or consequential damages, so the above limitations may not apply to you.

**Critical Control Applications:** Intel specifically disclaims liability for use of the adapter product in critical control applications (including, for example only, safety or health care control systems, nuclear energy control systems, or air or ground traffic control systems) by Licensee or Sublicensees, and such use is entirely at the user's risk. Licensee agrees to defend, indemnify, and hold Intel harmless from and against any and all claims arising out of use of the adapter product in such applications by Licensee or Sublicensees.

**Software:** Software provided with the adapter product is not covered under the hardware warranty described above. See the applicable software license agreement which shipped with the adapter product for details on any software warranty.

# FCC Compliance Statement

This device complies with Part 15 of the FCC Rules. Operation is subject to the two following conditions:

1. This device may not cause harmful interference.
2. This device must accept any interference received, including interference that may cause undesired operations.

The board has been tested and verified to be within the energy emission limits for Class B digital devices as defined in Part 15 of the FCC Rules. These limits are designed to provide reasonable protection against harmful interference in a residential situation. This board generates, uses and can radiate radio frequency energy and, if not installed and used in accordance with the instructions, may cause harmful interference to radio communications. Installed correctly, it probably will not interfere with your radio or TV. However, we do not guarantee the absence of interference.

If you modify the board in any way, without getting approval from Intel Corporation, your board may violate FCC regulations. Violation of FCC regulations may cause the FCC to void your right to use the modified board. Only peripherals (computer input/output devices, terminals, printers, etc.) certified to comply with the Class B limits may be attached to the computer containing the board. Operations with non-certified peripherals is likely to result in interference with radio and TV reception. NOTE: Use only shielded, grounded cables.

If you suspect this board is causing interference, turn your computer on and off while your radio or TV is showing interference. If the interference disappears when you turn the computer off and reappears when you turn the computer on, something in the computer is causing interference.

To reduce interference, try these suggestions:

- Change the direction of the radio or TV antenna.
- Move the computer or the radio or TV. For example, if the computer is to the right of the TV, move it to the left of the TV. Or, move the computer farther away from the radio or TV.
- Plug the computer into a different outlet. Don't plug your radio or TV into the same circuit as your computer.
- Ensure that all expansion slots (on the back or side of the computer) are covered. Also, ensure that all metal retaining brackets are tightly attached to the computer.

If these suggestions don't help, consult your computer dealer or an experienced radio/TV technician for more suggestions.

# Industry Canada's Compliance Statement

This Class B digital apparatus meets all requirements of the Canadian Interference-Causing Equipment Regulations.

Cet appareil numérique de la classe B respecte toutes les exigences du Règlement sur le matériel brouilleur du Canada.



# Intel Automated Customer Support

You can reach Intel's automated support services 24 hours a day, every day at no charge. The services contain the most up-to-date information about Intel products. You can access installation instructions, troubleshooting information, and general product information.

## Readme Files on Your Product Disk

To review the readme topics, insert the PRO/100+ Server adapter disk in a disk drive, switch to that drive, and type:

```
SETUP /README 
```

## Web and Internet Sites

Support: <http://support.intel.com>

Network Products: <http://www.intel.com/network>

Corporate: <http://www.intel.com>

FTP Host: [download.intel.com](http://download.intel.com)

FTP Directory: `/enduser_reseller/etherexpress_lan_adapters`

## BBS

Download software updates from the BBS.

US and Canada: 1-503-264-7999

Europe: +44-1793-432955

Worldwide: +1-503-264-7999

## Customer Support Technicians

US and Canada: 1-916-377-7000 (7:00 - 17:00 M-F Pacific Time)

Worldwide access: Intel has technical support centers worldwide. Many of the centers are staffed by technicians who speak the local languages. For a list of all Intel support centers, the telephone numbers, and the times they are open, download document 9089 from one of the automated services.

## Support Sites for Microsoft Patches

Service Pack 3:

<ftp://ftp.microsoft.com/bussys/winnt/winnt-public/fixes/usa/nt40/ussp3>

NDIS Driver Hotfix:

<ftp://ftp.microsoft.com/bussys/winnt/winnt-public/fixes/usa/nt40/hotfixes-postsp3/ndis-fix/>