

# ThinkPad<sup>®</sup> X61 Tablet

## Service and Troubleshooting Guide



# ThinkPad<sup>®</sup> X61 Tablet

## Service and Troubleshooting Guide

**Note**

Before using this information and the product it supports, be sure to read the following:

- *Safety and Warranty Guide* included in the package with this publication.
- Wireless related information in online *Access Help* and Appendix D, "Notices," on page 59.
- *Regulatory Notice* included in the package with this publication.

**First Edition (April 2007)**

**© Copyright Lenovo 2007. All rights reserved.**

U.S. GOVERNMENT USERS – RESTRICTED RIGHTS: Our products and/or services are provided with RESTRICTED RIGHTS. Use, duplication or disclosure by the Government is subject to the GSA ADP Schedule contract with Lenovo Group Limited, if any, or the standard terms of this commercial license, or if the agency is unable to accept this Program under these terms, then we provide this Program under the provisions set forth in Commercial Computer Software–Restricted Rights at FAR 52.227-19, when applicable, or under Rights in Data-General, FAR 52.227.14 (Alternate III).

---

# Contents

<b>Read first</b> . . . . .	<b>v</b>	<b>Chapter 4. Recovery options</b> . . . . .	<b>29</b>
<b>Chapter 1. Finding information</b> . . . . .	<b>1</b>	Introducing Rescue and Recovery . . . . .	29
This guide and other publications . . . . .	1	Restoring factory contents . . . . .	29
Finding information with the ThinkVantage button . . . . .	2	Recovering data . . . . .	30
<b>Chapter 2. Taking care of your ThinkPad computer</b> . . . . .	<b>3</b>	<b>Chapter 5. Upgrading and replacing devices</b> . . . . .	<b>31</b>
Important tips . . . . .	3	Replacing the battery . . . . .	31
Be careful about where and how you work . . . . .	3	Upgrading the hard disk drive . . . . .	33
Be gentle with your computer . . . . .	4	Replacing memory . . . . .	35
Carry your computer properly . . . . .	4	<b>Chapter 6. Getting help and service</b> . . . . .	<b>39</b>
Handle storage media and drives properly . . . . .	5	Getting help and service . . . . .	39
Take care in setting passwords . . . . .	5	Getting help on the Web . . . . .	39
Tips on using your computer in tablet mode . . . . .	5	Calling the Customer Support Center . . . . .	39
Tips on using the Tablet Digitizer Pen . . . . .	5	Getting help around the world . . . . .	41
Tips on using the touch panel . . . . .	5	Worldwide telephone list . . . . .	41
Other important tips . . . . .	6	<b>Appendix A. Warranty information</b> . . . . .	<b>47</b>
Cleaning the cover of your computer . . . . .	7	Types of warranty service . . . . .	48
Cleaning your computer keyboard . . . . .	7	<b>Appendix B. Customer Replaceable Units (CRUs)</b> . . . . .	<b>51</b>
Cleaning your computer display . . . . .	8	<b>Appendix C. Features and Specifications</b> . . . . .	<b>55</b>
Cleaning the touch panel display . . . . .	8	Features . . . . .	55
Care for the fingerprint reader . . . . .	8	Specifications . . . . .	56
<b>Chapter 3. Solving computer problems</b> . . . . .	<b>9</b>	<b>Appendix D. Notices</b> . . . . .	<b>59</b>
Frequently asked questions . . . . .	10	Notices . . . . .	59
Diagnosing problems . . . . .	11	Electronic emissions notices . . . . .	60
HDD diagnostic program . . . . .	11	Federal Communications Commission (FCC) Statement . . . . .	60
Diagnosing problems using PC-Doctor from the service partition . . . . .	12	Industry Canada Class B emission compliance statement . . . . .	61
Troubleshooting . . . . .	13	Avis de conformité à la réglementation d'Industrie Canada . . . . .	61
Error messages . . . . .	13	European Union EMC Directive conformance statement . . . . .	61
Errors without messages . . . . .	18	Japanese VCCI Class B statement . . . . .	62
Password problems . . . . .	19	EU WEEE Statements . . . . .	62
Keyboard problems . . . . .	19	Notice for users in the U.S.A. . . . .	62
Pointing device problems . . . . .	20	IBM Lotus Software Offer . . . . .	63
Sleep (standby) or hibernation problems . . . . .	20	Trademarks . . . . .	65
Computer screen problems . . . . .	21		
Battery problems . . . . .	23		
Hard disk drive problems . . . . .	24		
Fingerprint authentication problems . . . . .	25		
Startup problems . . . . .	25		
Other problems . . . . .	26		
Starting BIOS Setup Utility . . . . .	26		

**Index . . . . . 67**

---

## Read first



When your computer is turned on or the battery is charging, the base, the palm rest, and some other parts may become hot. Avoid keeping your hands, your lap, or any other part of your body in contact with a hot section of the computer for any extended length of time. When you use the keyboard, avoid keeping your palms on the palm rest for a prolonged period of time.

Your computer generates some heat during normal operation. The amount of heat depends on the amount of system activity and the battery charge level. Extended contact with your body, even through clothing, could cause discomfort or even a skin burn. Periodically take breaks from using the keyboard by lifting your hands from the palm rest; and be careful not to use the keyboard for any extended length of time.



When the ac adapter is connected to an electrical outlet and your computer, it generates heat. Do not place the adapter in contact with any part of your body while using it. Never use the ac adapter to warm your body. Extended contact with your body, even through clothing, may cause a skin burn.

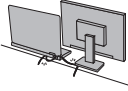

Route the cables of an ac adapter, a mouse, a keyboard, a printer, or any other electronic device, or communication lines, so that they cannot be walked on, tripped over, pinched by your computer or other objects, or in any way subjected to treatment that could disturb the operation of your computer. Applying strong force to the cables may damage or break them.



Before moving your computer, do one of the following: turn it off, press Fn+F4 to put it in sleep (standby) mode, or press Fn+F12 to put it in hibernation mode.

Before moving the computer, make sure that the power on indicator is off. This will help to prevent damage to the hard disk drive, and possible loss of data.



Do not drop, bump, scratch, twist, hit, vibrate, push or place heavy objects on your computer, display, or external devices.





Use a quality carrying case that provides adequate cushion and protection. Do not pack your computer in a tightly packed suitcase or bag.



Place liquids away from your computer to avoid spills, and keep your computer away from water to avoid the danger of electrical shock.

*Read first*

---

# Chapter 1. Finding information

---

## This guide and other publications

### *Setup Instructions*

helps you to unpack your ThinkPad computer and get started. It includes a few tips for first-time users, and introduces software preinstalled by Lenovo™.

### *This Service and Troubleshooting Guide*

provides information about caring for your ThinkPad computer, basic troubleshooting information, some recovery procedures, help and service information, and warranty information for your computer. The troubleshooting information in this Guide applies only to problems that might prevent you from accessing the comprehensive online manual, called *Access Help*, preinstalled on your ThinkPad computer.

### *Access Help*

is a comprehensive online manual that provides answers to most of your questions about your computer, helps you to configure preloaded features and tools, or solve problems. To open *Access Help*, do either of the following:

- Press the ThinkVantage® button. Under Quick Links in the Productivity Center, click **Access on-system help**.
- Click **Start**, move the pointer to **All Programs**; then to **ThinkVantage**. Click **Access Help**.

### *Productivity Center*

provides an easy access to software tools and key Lenovo sites, eliminating the need to carry other reference manuals around. To open Productivity Center, press the blue ThinkVantage button on your keyboard. For more information about using the ThinkVantage button, see "Finding information with the ThinkVantage button" on page 2.

### *Safety and Warranty Guide*

includes general safety instructions and complete Lenovo Limited Warranty.

### *Regulatory Notice*

supplements this Guide. Read it before you use the wireless features of your ThinkPad computer. The ThinkPad computer complies with the radio frequency and safety standards of any country or region in which it has been approved for wireless use. You are requested to install and use your ThinkPad computer in strict accordance with the local RF regulations.

---

## Finding information with the ThinkVantage button

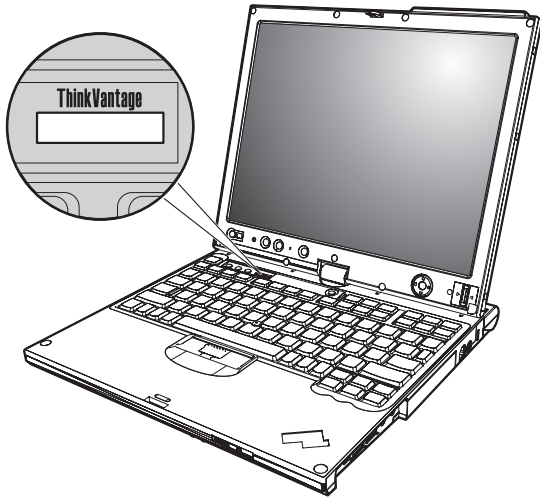

The blue ThinkVantage button can help you in many situations when your computer is working normally, and even when it is not. Press the ThinkVantage button to open the Productivity Center and get access to informative illustrations and easy-to-follow instructions for getting started and staying productive.

You can also use the ThinkVantage button to interrupt the startup sequence of your computer and start the Rescue and Recovery™ workspace, which runs independently of the Windows operating system and is hidden from it.

---

## Chapter 2. Taking care of your ThinkPad computer

Though your computer is designed to function reliably in normal work environments, you need to use common sense in handling it. By following these important tips, you will get the most use and enjoyment out of your computer.

---

### Important tips

#### Be careful about where and how you work

- When your computer is turned on or the battery is charging, the base, the palm rest, and some other parts may become hot. Avoid keeping your hands, your lap, or any other part of your body in contact with a hot section of the computer for any extended length of time. When you use the keyboard, avoid keeping your palms on the palm rest for a prolonged period of time.

Your computer generates some heat during normal operation. The amount of heat depends on the amount of system activity and the battery charge level. Extended contact with your body, even through clothing, could cause discomfort or even a skin burn. Periodically take breaks from using the keyboard by lifting your hands from the palm rest; and be careful not to use the keyboard for any extended length of time.

- When the ac adapter is connected to an electrical outlet and your computer, it generates heat. Do not place the adapter in contact with any part of your body while using it. Never use the ac adapter to warm your body. Extended contact with your body, even through clothing, may cause a skin burn.
- Route the cables of an ac adapter, a mouse, a keyboard, a printer, or any other electronic device, or communication lines, so that they cannot be walked on, tripped over, pinched by your machine or other objects, or in any way subjected to treatment that could disturb the operation of your computer. Applying strong force to the cables may damage or break them.
- Place liquids away from your computer to avoid spills, and keep your computer away from water (to avoid the danger of electrical shock).
- Store packing materials safely out of the reach of children to prevent the risk of suffocation from plastic bags.
- Keep your computer away from magnets, activated cellular phones, electrical appliances, or speakers (within 13 cm or 5 in).
- Avoid subjecting your computer to extreme temperatures (below 5°C/41°F or above 35°C/95°F).

## *Taking care of your ThinkPad computer*

- Some appliances, such as certain portable desktop fans or air purifiers, can produce negative ions. If a computer is close to such an appliance, and is exposed for an extended time to air containing negative ions, it may become electrostatically charged. Such a charge may be discharged through your hands when you touch the keyboard or other parts of the computer, or through connectors on I/O devices connected to it. Even though this kind of electrostatic discharge (ESD) is the opposite of a discharge from your body or clothing to the computer, it poses the same risk of a computer malfunction.

Your computer is designed and manufactured to minimize any effects of electrostatic charge. An electrostatic charge above a certain limit, however, can increase the risk of ESD. Therefore, when using the computer close to an appliance that can produce negative ions, give special attention to the following:

- Avoid directly exposing your computer to the air from an appliance that can produce negative ions.
- Keep your computer and peripherals as far as possible from such an appliance.
- Wherever possible, ground your computer to facilitate safe electrostatic discharge.

**Note:** Not all such appliances cause a significant electrostatic charge.

### **Be gentle with your computer**

- Avoid placing any objects (including paper) between the display and the keyboard or under the keyboard.
- Do not drop, bump, scratch, twist, hit, vibrate, push, or place heavy objects on your computer, display, or external devices.
- Your computer display is designed to be opened and used at an angle slightly greater than 90 degrees. Do not open the display beyond 180 degrees, as this might damage the computer hinge.

### **Carry your computer properly**

- Before moving your computer, be sure to remove any media, turn off attached devices, and disconnect cords and cables.
- Be sure your computer is in sleep (standby) or hibernation mode, or turned off, before moving it. This will prevent damage to the hard disk drive and data loss.
- When picking up your open computer, hold it by the bottom. Do not pick up or hold your computer by the display.
- Use a quality carrying case that provides adequate cushion and protection. Do not pack your computer in a tightly packed suitcase or bag.

### **Handle storage media and drives properly**

- If your computer comes with a diskette drive, avoid inserting diskettes at an angle and attaching multiple or loose diskette labels, as these can lodge in the drive.
- If your computer comes with an optical drive, do not touch the surface of a disc or the lens on the tray.
- Wait until you hear the CD or DVD click into the center pivot of an optical drive before closing the tray.
- When installing your hard disk, diskette or optical drive, follow the instructions shipped with your hardware, and apply pressure only where needed on the device.

### **Take care in setting passwords**

- Remember your passwords. If you forget a supervisor or hard disk password, Lenovo authorized service provider will not reset it, and you might have to replace your system board or hard disk drive.

### **Tips on using your computer in tablet mode**

- To close the computer display, first make sure that the display either faces the keyboard or is positioned at 180 degrees to the keyboard, so that the back of the display faces the keyboard.
- Do not pick up or hold the computer by the display only.
- Do not hit, vibrate, or bump the computer display.
- To allow free ventilation, do not place any obstacle, such as a thick-piled carpet or a soft cushion, in front of the fan.
- When you use the computer in picture frame mode, hold the display with one hand and use the Tablet Digitizer Pen.
- If you hold the computer in one hand while using it in tablet mode, do not expose it to excessive vibration, shock, or rotation.
- Do not use the computer outdoors. Do not expose it to rain.
- If you put your computer in a carrying case, put it into notebook mode and close the display.

### **Tips on using the Tablet Digitizer Pen**

- Use only the Tablet Digitizer Pen that was shipped with your ThinkPad X61 Tablet computer or that you purchased with that computer as an option. Only this pen is designed for use with the ThinkPad X61 Tablet computer. Any other pen might stick in the penholder or cause other problems.
- The Tablet Digitizer Pen is not waterproof. Take care not to soak or dip the pen in water.

### **Tips on using the touch panel**

- The touch panel is a glass panel covered with a plastic film. For input you can use either your finger or the Tablet Digitizer Pen shipped with your

## *Taking care of your ThinkPad computer*

computer. Do not use any pen other than the specified one, or any metallic object, because to do so might damage the touch panel or cause it to malfunction.

- If you put your computer in a carrying case, put it into notebook mode and close the display. Do not carry your computer in tablet mode.
- If you use both your finger and the Tablet Digitizer Pen simultaneously for input to the screen, only data entered by use of the Digitizer Pen will be processed.
- If you use your finger to input to the touch panel, touch only one point at a time. If you touch several points simultaneously, the input will not be processed correctly.
- With the touch panel, gradually a discrepancy may start to appear between the point you touched with your finger during the finger point, and its actual position on the screen. To avoid this, regularly correct the accuracy of the finger input by use of the touch panel Settings Utility.

### **Other important tips**

- Your computer modem might use only an analog telephone network, or public-switched telephone network (PSTN). Do not connect the modem to a PBX (private branch exchange) or any other digital telephone extension line because this could damage your modem. Analog phone lines are often used in homes, while digital phone lines are often used in hotels or office buildings. If you are not sure which kind of phone line you are using, contact your telephone company.
- Your computer might have both an Ethernet connector and a modem connector. If so, be sure to connect your communication cable to the correct one, so your connector is not damaged.
- Register your ThinkPad products with Lenovo (visit the following Web site: <http://www.lenovo.com/register>). This can help authorities return your computer to you if it is lost or stolen. Registering your computer also enables Lenovo to notify you about possible technical information and upgrades.
- Only an authorized ThinkPad repair technician should disassemble and repair your computer.
- Do not modify or tape the latches to keep the display open or closed.
- Take care not to turn your computer over while the ac adapter is plugged in. This could break the adapter plug.
- Turn off your computer if you are replacing a device in a device bay, or else verify that the device is warm- or hot-swappable.
- If you exchange drives in your computer, reinstall the plastic bezel faces (if supplied).
- Store your external and removable hard disk, diskette or optical drives in the appropriate containers or packaging when they are not being used.



- Before you install any of the following devices, touch a metal table or a grounded metal object. This action reduces any static electricity from your body. The static electricity could damage the device.
  - PC Card
  - Smart Card
  - Memory Card, such as xD-Picture Card, SD Card, Memory Stick, and MultiMediaCard
  - Memory module
  - PCI Express Mini Card
  - Communication Daughter Card
- When transferring data to or from a Flash Media Card, such as an SD card, do not put your computer in sleep (standby) or hibernation mode before the data transfer is complete. To do so might cause damage to your data.

### **Cleaning the cover of your computer**

Occasionally clean your computer as follows:

1. Prepare a mixture of a gentle kitchen-use detergent (one that does not contain abrasive powder or strong chemicals such as acid or alkaline). Use 5 parts water to 1 part detergent.
2. Absorb the diluted detergent into a sponge.
3. Squeeze excess liquid from the sponge.
4. Wipe the cover with the sponge, using a circular motion and taking care not to let any excess liquid drip.
5. Wipe the surface to remove the detergent.
6. Rinse the sponge with clean running water.
7. Wipe the cover with the clean sponge.
8. Wipe the surface again with a dry, soft lint-free cloth.
9. Wait for the surface to dry completely and remove any cloth fibers from the computer surface.

### **Cleaning your computer keyboard**

1. Absorb some isopropyl rubbing alcohol on a soft, dust-free cloth.
2. Wipe each keytop surface with the cloth. Wipe the keys one by one; if you wipe several keys at a time, the cloth may hook onto an adjacent key and possibly damage it. Make sure that no liquid drips onto or between the keys.
3. Allow to dry.
4. To remove any crumbs and dust from beneath the keys, you can use a camera blower with a brush or cool air from a hair dryer.

**Note:** Avoid spraying cleaner directly on the display or the keyboard.

### **Cleaning your computer display**

1. Gently wipe the display with a dry, soft lint-free cloth. If you see a scratch-like mark on your display, it might be a stain transferred from the keyboard or the TrackPoint® pointing stick when the cover was pressed from the outside.
2. Wipe or dust the stain gently with a soft, dry cloth.
3. If the stain remains, moisten a soft, lint-free cloth with water or a 50-50 mixture of isopropyl alcohol and water that does not contain impurities.
4. Wring out as much of the liquid as you can.
5. Wipe the display again; do not let any liquid drip into the computer.
6. Be sure to dry the display before closing it.

### **Cleaning the touch panel display**

1. To remove fingerprints, etc., from the touch panel display, use a dry, soft, lint-free cloth. (A piece of absorbent cotton will also serve the purpose.) Do not apply solvents to the cloth.
2. Gently wipe foreign particles and dust from the touch panel with one side of the cloth.
3. Wipe smudges or fingerprints with the other side of the cloth, or with a clean cloth.
4. After using the cloth, wash it with a neutral detergent.

### **Care for the fingerprint reader**

The following actions could damage the fingerprint reader or cause it not to work properly:

- Scratching the surface of the reader with a hard, pointed object.
- Scraping the surface of the reader with your nail or anything hard.
- Using or touching the reader with a dirty finger.

If you notice any of the following conditions, gently clean the surface of the reader with a dry, soft, lint-free cloth:

- The surface of the reader is dirty or stained.
- The surface of the reader is wet.
- The reader often fails to enroll or authenticate your fingerprint.

---

## Chapter 3. Solving computer problems

Frequently asked questions . . . . .	10	Pointing device problems . . . . .	20
Diagnosing problems . . . . .	11	Sleep (standby) or hibernation problems . . . . .	20
HDD diagnostic program . . . . .	11	Computer screen problems . . . . .	21
Diagnosing problems using PC-Doctor from the service partition . . . . .	12	Battery problems . . . . .	23
Troubleshooting. . . . .	13	Hard disk drive problems . . . . .	24
Error messages . . . . .	13	Fingerprint authentication problems . . . . .	25
Errors without messages . . . . .	18	Startup problems . . . . .	25
Password problems . . . . .	19	Other problems . . . . .	26
Keyboard problems . . . . .	19	Starting BIOS Setup Utility . . . . .	26

**Note:** See *Access Help* if your system is running and *Access Help* is accessible. This chapter presents information for use when *Access Help* is inaccessible.

## Frequently asked questions

This section lists frequently asked questions and tells where you can find detailed answers. For details about each publication included in the package with the ThinkPad computer, see “This guide and other publications” on page 1.

### **What safety precautions should I follow when using my ThinkPad computer?**

See the separate *Safety and Warranty Guide* for detailed information about safety.

### **How can I prevent problems with my ThinkPad computer?**

See “Read first” on page v, and also Chapter 2, “Taking care of your ThinkPad computer,” on page 3 of this Guide. More tips can be found in the following sections of *Access Help*:

- Preventing problems
- Troubleshooting

### **What are the main hardware features of my new ThinkPad computer?**

See the “ThinkPad tour” section of *Access Help*.

### **Where can I find the detailed specifications for my machine?**

See <http://www.lenovo.com/think/support>.

### **I need to upgrade a device or I need to replace one of the following: the hard disk drive, the PCI Express Mini Card, the Modem Daughter Card, memory, the keyboard, or the palm rest.**

See the Appendix B, “Customer Replaceable Units (CRUs),” on page 51 section of this Guide for the list of Customer Replaceable Units and the location of the instructions for removing or replacing components.

### **My computer is not operating properly.**

Study the “Problem solving ” section of *Access Help*. This Guide describes only problems that might prevent you from accessing the online help system.

### **Where are the recovery discs?**

Your computer did not come with a recovery disc or Windows disc. For an explanation of the alternative recovery methods offered by Lenovo, see “Restoring factory contents” on page 29 of this Guide.

**How can I contact the Customer Support Center?**

See Chapter 6, “Getting help and service,” on page 39 of this Guide. For the phone numbers of the Customer Support Center nearest to you, see “Worldwide telephone list” on page 41.

**Where can I find warranty information?**

See the separate *Safety and Warranty Guide* for detailed warranty information. For the warranty applicable to your computer, including the warranty period and type of warranty service, see Appendix A, “Warranty information,” on page 47.

---

**Diagnosing problems**

If you have a problem with your computer, you can test it by using PC-Doctor® for Windows. To run PC-Doctor for Windows, do as follows:

1. Click **Start**.
2. Move the pointer to **All Programs** and then to **PC-Doctor for Windows**.
3. Click **PC-Doctor**.

For more information about PC-Doctor for Windows, see the Help for the program.

**Attention**

Running any tests can take up to several minutes or longer. Make sure you have time to run the entire test; do not interrupt the test while it is running.

When preparing to contact the Customer Support Center, be sure to print the test log so that you can rapidly provide information to the help technician.

**HDD diagnostic program**

If your hard disk drive is not operating properly, you may be able to find the problem by running the HDD diagnostic program in the BIOS Setup Utility.

To start the diagnostic program, do as follows:

1. If the diskette drive is connected to the computer, remove any diskette from the diskette drive, and then turn off the computer.
2. Turn on the computer.
3. While the message, “To interrupt normal startup, press the blue ThinkVantage button,” is displayed at the lower left of the screen, press F1 to enter BIOS Setup Utility.

4. Using cursor keys, select **HDD diagnostic program** and press Enter. The menu for the HDD diagnostic program opens.
5. Using cursor keys, select **Main hard disk drive** or **Ultrabay hard disk drive**. Press Enter to start the diagnostic program. The HDD diagnostic program runs a read verification test and a speed test of the drive you select, and reports its findings.
6. If the diagnostic program returns any error messages, call the Customer Support Center for service. The diagnostic program may return one of the following error messages:

For the main hard disk drive:

- Error code 0000: Read verification failed
- Error code 0100: Speed test failed
- Error code 0200: Controller Diag failed

For the Ultrabay™ hard disk drive:

- Error code 0002: Read verification failed
- Error code 0102: Speed test failed
- Error code 0202: Controller Diag failed

7. If the diagnostic program returns no error message but you still have some concerns, see the instructions in the "Introducing Rescue and Recovery" section in online *Access Help*, and run the program for a diagnostic test of the hard disk drive. You can also download PC-Doctor for DOS for your computer from the following Web site:

<http://www.lenovo.com/support/site.wss/document.do?sitestyle=lenovo&Indocid=tpad-matrix>

### Diagnosing problems using PC-Doctor from the service partition

By using PC-Doctor from the Rescue and Recovery workspace in the service partition of the hard disk drive, you can diagnose your system without starting up the operating system. Do as follows:

1. If the diskette drive is connected to the computer, remove any diskette from the diskette drive, and then turn off the computer.
2. Turn on the computer.
3. While the message, "To interrupt normal startup, press the blue ThinkVantage button," is displayed at the lower left of the screen, press the blue ThinkVantage button to enter the Rescue and Recovery workspace.
4. Select **Diagnose hardware**. The computer restarts and PC-Doctor starts up.

For more information about PC-Doctor, press F1 to go to the Help or online manual for the program.

## Troubleshooting

If you do not find your problem here, see *Access Help*. The following section only describes problems that might prevent you from accessing this help system.

### Error messages

#### Notes:

1. In the charts, x can be any character.
2. The version of PC-Doctor referred to here is PC-Doctor for Windows.

Message	Solution
0176: System Security - The System has been tampered with.	This message is displayed if you remove the Security Chip and reinstall it, or install a new one. To clear the error, enter the BIOS Setup Utility. If this does not solve the problem, have the computer serviced.
0182: Bad CRC2. Enter BIOS Setup and load Setup defaults.	Checksum of the CRC2 setting in the EEPROM is not correct. Press F1 to go to BIOS Setup Utility. Press F9 and then Enter to load the default setting. Press F10 and then Enter to restart the system.
0185: Bad startup sequence settings. Enter BIOS Setup and load Setup defaults.	Checksum of the startup sequence setting in the EEPROM is not correct. Press F1 to go to BIOS Setup Utility. Press F9 and then Enter to load the default setting. Press F10 and then Enter to restart the system.
0190: Critical low-battery error	The computer turned off, because the battery is low. Connect the ac adapter to the computer and charge the battery, or replace the battery with a fully charged one.
0191: System Security - Invalid remote change requested.	The system configuration change has failed. Confirm the operation and try again. To clear the error, enter the BIOS Setup Utility.
0199: System Security - Security password retry count exceeded.	This message is displayed if you enter a wrong supervisor password more than three times. Confirm the supervisor password and try again. To clear the error, enter the BIOS Setup Utility.
01C8: More than one modem devices are found. Remove one of them. Press <Esc> to continue.	Remove one of the Modem Daughter Cards. Otherwise, press Esc to ignore the warning message. If this does not solve the problem, have the computer serviced.

## Solving computer problems

Message	Solution
01C9: More than one Ethernet devices are found. Remove one of them. Press <Esc> to continue.	Your ThinkPad computer has a built-in Ethernet feature, and you cannot add another such feature by installing an Ethernet device such as a Mini-PCI Ethernet Card or an Ethernet Daughter Card. If this error message is displayed, remove the Ethernet device that you installed. Otherwise press Esc to ignore the warning message. If this does not solve the problem, have the computer serviced.
0200: Hard disk error	The hard disk is not working. Make sure that the hard disk drive is attached firmly. Run the BIOS Setup Utility; then make sure the hard disk drive is not disabled in the Startup menu.
021x: Keyboard error	<p>Make sure that there are no objects placed on the keyboard, or if you have one, the external keyboard. Turn off the computer, and turn off all attached devices. Turn on the computer first; then turn on the attached devices.</p> <p>If you still see the same error code, do the following:</p> <p>If an external keyboard is connected, do the following:</p> <ul style="list-style-type: none"> <li>• Turn off the computer and disconnect the external keyboard; then turn on the computer. Make sure that the built-in keyboard operates correctly. If it does, have the external keyboard serviced.</li> <li>• Make sure that the external keyboard is connected to the correct connector.</li> </ul> <p>Test the computer by using PC-Doctor.</p> <ul style="list-style-type: none"> <li>• If the computer stops during the test, have the computer serviced.</li> </ul>
0230: Shadow RAM error	The shadow RAM failed. Test your computer's memory with PC-Doctor. If you added a memory module just before turning the computer on, reinstall it. Then test the memory with PC-Doctor.
0231: System RAM error	The system RAM failed. Test your computer's memory with PC-Doctor. If you added a memory module just before turning the computer on, reinstall it. Then test the memory with PC-Doctor.
0232: Extended RAM error	The extended RAM failed. Test your computer's memory with PC-Doctor. If you have increased memory just before turning the computer on, reinstall it. Then test the memory with PC-Doctor.
0250: System battery error	The backup battery, which is used to preserve the configuration information, such as the date and time, while the computer is turned off, is depleted. Replace the battery and run BIOS Setup Utility to verify the configuration. If you still have a problem, have the computer serviced.



Message	Solution
0251: System CMOS checksum bad	The system CMOS might have been corrupted by an application program. The computer uses the default settings. Run BIOS Setup Utility to reconfigure the settings. If you still see the same error code, have the computer serviced.
0271: Date and time error	Neither the date nor the time is set in the computer. Set the date and time, using the BIOS Setup Utility.
0280: Previous boot incomplete	Your computer was previously unable to complete the boot process.  Turn the computer off; then turn it on to start the BIOS Setup Utility. Verify the configuration and then restart the computer either by choosing the <b>Exit Saving Changes</b> option under the <b>Restart</b> item or by pressing F10. If you still see the same error code, have the computer serviced.
1802: Unauthorized network card is plugged in - Power off and remove the miniPCI network card.	The Mini-PCI network card is not supported on this computer. Remove it.
1803: Unauthorized daughter card is plugged in - Power off and remove the daughter card.	The daughter card is not supported on this computer. Remove it.
1804: Unauthorized WAN card is plugged in - Power off and remove the WAN card.	The WAN card is not supported on this computer. Remove it.
2100: Initialization error on HDD0 (Main hard disk drive)	The hard disk is not working. Have the hard disk serviced.
2102: Initialization error on HDD1 (Ultrabay hard disk drive)	The hard disk is not working. Have the hard disk serviced.
2110: Read error on HDD0 (Main hard disk drive)	The hard disk is not working. Have the hard disk serviced.
2112: Read error on HDD1 (Ultrabay hard disk drive)	The hard disk is not working. Have the hard disk serviced.

## Solving computer problems

Message	Solution
The power-on password prompt	A power-on password or a supervisor password is set. Type the password and press Enter to use the computer. If the power-on password is not accepted, a supervisor password might have been set. Type the supervisor password and press Enter. If you still see the same error message, have the computer serviced.
The hard disk password prompt	A hard disk password is set. Type the password and press Enter to use the computer.  If you still see the same error message, have the computer serviced.
Hibernation error	The system configuration changed between the time your computer entered hibernation mode and the time it left this mode, and your computer cannot resume normal operation. <ul style="list-style-type: none"><li>• Restore the system configuration to what it was before your computer entered hibernation mode.</li><li>• If the memory size has been changed, re-create the hibernation file.</li></ul>
Operating system not found.	Verify the following: <ul style="list-style-type: none"><li>• The hard disk drive is correctly installed.</li><li>• A startable disc is in the drive.</li></ul> If you still see the same error message, check the boot sequence, using the BIOS Setup Utility.
EMM386 Not Installed - Unable to Set Page Frame Base Address.	Edit C:\CONFIG.SYS and change a line from device=C:\WINDOWS\EMM386.EXE RAM  to device=C:\WINDOWS\EMM386.EXE NOEMS  and save this file.
CardBus Configuration Error - Device Disabled	Go to the BIOS Setup Utility. Press F9 and then Enter to load the default setting.  Press F10 and then Enter to restart the system.

Message	Solution
Cannot boot from any device.	<p>Check the status of the device which you want to boot from.</p> <p>Device not found Check the device you want to boot from.</p> <p>Device error Check the device you want to boot from.</p> <p>No valid operating system Check that the operating system has no failure and is installed correctly.</p> <p>Excluded from boot order Open the BIOS Setup Utility and add the device to boot order.</p>

<b>If one of the following error code messages is displayed on the screen, have the computer serviced:</b>
0175: Bad CRC1, stop POST task
0177: Bad SVP data, stop POST task. Checksum of the supervisor password in the EEPROM is not correct.
0187: EAIA data access error
0188: Invalid RFID serialization information area
0189: Invalid RFID configuration information area
0192: System Security - Embedded Security hardware tamper detected.
0260: System timer error
0270: Real time clock error
02D0: System cache error
02F4: EISA CMOS not writable
02F5: DMA test failed
02F6: Software NMI failed
02F7: Fail-safe timer NMI failed
Fan error
Thermal sensing error

## Errors without messages

<b>Problem:</b>	When I turn on the machine, nothing appears on the screen and the machine does not beep while starting up. <b>Note:</b> If you are not sure whether you heard any beeps, turn off the computer by pressing and holding the power button for more than 4 seconds; then turn it on and listen again. If you are using an external monitor, see “Computer screen problems” on page 21.
<b>Solution:</b>	If a power-on password is set, press any key to display the power-on password prompt, and then type the correct password and press Enter.  If the power-on password prompt does not appear, the brightness level might be set to minimum brightness. Adjust the brightness level by pressing the Fn+Home.  If the screen still remains blank, make sure that: <ul style="list-style-type: none"><li>• The battery is installed correctly.</li><li>• The ac adapter is connected to the computer and the power cord is plugged into a working electrical outlet.</li><li>• The computer power is on. (Turn on the power switch again for confirmation.)</li></ul> If these items are properly set, and the screen remains blank, have the computer serviced.
<b>Problem:</b>	When I turn on the machine, nothing appears on the screen, but I hear two or more beeps.
<b>Solution:</b>	Make sure that the memory card is installed correctly. If it is, but the screen is still blank, and you hear five beeps, have the computer serviced.  If you hear 4 cycles of 4 beeps each, the Security Chip has a problem. Have the computer serviced.
<b>Problem:</b>	When I turn on the machine, only a white pointer appears on a blank screen.
<b>Solution:</b>	Reinstall your operating system (see Chapter 4, “Recovery options,” on page 29) and turn on the computer. If you still see only the pointer on the screen, have the computer serviced.
<b>Problem:</b>	My screen goes blank while the computer is on.
<b>Solution:</b>	Your screen saver or power management may be enabled. Move the TrackPoint or press a key to exit the screen saver, or press the power switch to resume from sleep (standby) or hibernation.

## Password problems

<b>Problem:</b>	I forgot my password.
<b>Solution:</b>	<p>If you have registered your computer for Password Reset Service, and you forgot your power-on or hard disk password, you can reset it by pressing the ThinkVantage button at the password prompt.</p> <ul style="list-style-type: none"> <li>• If you cannot reset your power-on password, you must take your computer to a Lenovo authorized servicer or a marketing representative to have the password canceled.</li> <li>• If you cannot reset your hard disk password, Lenovo authorized servicer cannot reset your password or recover data from the hard disk. You must take your computer to a Lenovo authorized servicer or a marketing representative to have the hard disk drive replaced. Proof of purchase is required, and a fee will be charged for parts and service.</li> </ul> <p>If you forgot your supervisor password, Lenovo authorized servicer cannot reset your password. You must take your computer to a Lenovo authorized servicer or a marketing representative to have the system board replaced. Proof of purchase is required, and a fee will be charged for parts and service.</p>

## Keyboard problems

<b>Problem:</b>	All or some of the keys on the keyboard do not work.
<b>Solution:</b>	<ul style="list-style-type: none"> <li>• If the problem occurred immediately after the computer returned from sleep (standby) mode, enter the power-on password if one has been set.</li> <li>• If an external numeric keypad or a mouse is connected: <ol style="list-style-type: none"> <li>1. Turn off the computer.</li> <li>2. Remove the external numeric keypad or the mouse.</li> <li>3. Turn on the computer and try using the keyboard again.</li> </ol> <p>If the keyboard problem is resolved, carefully reconnect the external numeric keypad, external keyboard, or mouse, making sure that you have seated the connectors properly.</p> <p>If keys on the keyboard still do not work, have the computer serviced.</p> </li> </ul>
<b>Problem:</b>	A number appears when you type a letter.
<b>Solution:</b>	The numeric lock function is on. To disable it, press and hold Shift or Fn and then press NmLk (ScrLk).

## Pointing device problems

<b>Problem:</b>	The scrolling or magnifying glass function does not work.
<b>Solution:</b>	Check the mouse driver in the Device Manager window, and make sure that the PS/2 TrackPoint driver is installed.

## Sleep (standby) or hibernation problems

<b>Problem:</b>	The computer enters sleep (standby) mode (the sleep/standby indicator turns on) immediately after Power-on self-test (POST).
<b>Solution:</b>	Make sure that: <ul style="list-style-type: none"><li>• The battery is charged.</li><li>• The operating temperature is within the acceptable range. See “Specifications” on page 56.</li></ul> If these items are correct, have the computer serviced.
<b>Problem:</b>	The critical low-battery error message is displayed, and the computer immediately turns off.
<b>Solution:</b>	The battery power is getting low. Connect the ac adapter to the computer and plug it into an electrical outlet, or replace the battery with a fully charged one.
<b>Problem:</b>	The computer does not return from sleep (standby) mode, or the sleep (standby) indicator stays on and the computer does not work.
<b>Solution:</b>	If the system does not return from sleep (standby) mode, it may have entered sleep (standby) or hibernation mode automatically because the battery is depleted. Check the sleep (standby) indicator. <ul style="list-style-type: none"><li>• If the sleep (standby) indicator is on, your computer is in sleep (standby) mode. Connect the ac adapter to the computer; then press Fn.</li><li>• If the sleep (standby) indicator is off, your computer is in hibernation mode or power-off state. Connect the ac adapter to the computer; then press power button to resume operation.</li></ul> If the system still does not return from sleep (standby) mode, your system may stop responding and you cannot turn off the computer. Reset the computer. Unsaved data may be lost. To reset the computer, press and hold the power button for 4 seconds or more. If the computer is not reset, remove the ac adapter and the battery.

<b>Problem:</b>	When you take action to return from sleep (standby) mode, the computer display remains blank.
<b>Solution:</b>	Check whether an external monitor was disconnected or turned off while the computer was in sleep (standby) mode. If you disconnected or turned off the external monitor, connect it or turn it on before resuming the computer from the sleep (standby) mode. When resuming the computer from the sleep (standby) mode without attaching the external monitor or turning it on, and the computer display remains blank, press Fn+F7 to bring up the computer display. <b>Note:</b> If you use the Fn+F7 key combination to apply a presentation scheme, press Fn+F7 at least three times in three seconds, and the image is displayed on the computer screen.
<b>Problem:</b>	The computer enters sleep (standby) mode unexpectedly.
<b>Solution:</b>	If the processor overheats, the computer automatically enters sleep (standby) mode to allow the computer to cool and to protect the processor and other internal components. Also, check the settings for sleep (standby) mode, using Power Manager.

### Computer screen problems

<b>Problem:</b>	Incorrect characters appear on the screen.
<b>Solution:</b>	Did you install the operating system or application program correctly? If they are installed and configured correctly, have the computer serviced.
<b>Problem:</b>	Missing, discolored, or bright dots appear on the screen every time you turn on your computer.
<b>Solution:</b>	This is an intrinsic characteristic of the TFT technology. Your computer's display contains multiple thin-film transistors (TFTs). A small number of missing, discolored, or bright dots on the screen might exist all the time.

<p><b>Problem:</b> The screen is blank.</p> <p><b>Solution:</b></p> <ul style="list-style-type: none"><li>• Press Fn+F7 to bring up the image. <b>Note:</b> If you use the Fn+F7 key combination to apply a presentation scheme, press Fn+F7 at least three times in three seconds, and the image is displayed on the computer screen.</li><li>• If you are using the ac adapter, or using the battery, and the battery status indicator is on (is green), press Fn+Home to make the screen brighter.</li><li>• If the sleep (standby) status indicator is on (is green), press Fn to resume from the sleep (standby) mode.</li><li>• If you still have the problem, do the Solution in the following problem "The screen is unreadable or distorted."</li></ul>
<p><b>Problem:</b> The screen is unreadable or distorted.</p> <p><b>Solution:</b> Make sure that:</p> <ul style="list-style-type: none"><li>• The display device driver is installed correctly.</li><li>• The screen resolution and color quality are correctly set.</li><li>• The monitor type is correct.</li></ul> <p>To check these settings, do as follows:</p> <p><b>For Windows Vista™:</b></p> <ol style="list-style-type: none"><li>1. Right-click on the desktop, click <b>Personalize</b>, then click <b>Display Settings</b>.</li><li>2. Check whether the screen resolution and color quality are correctly set.</li><li>3. Click <b>Advanced Settings</b>.</li><li>4. Click the <b>Adapter</b> tab.</li><li>5. Make sure the correct device driver name is shown in the adapter information window. <b>Note:</b> The device driver name depends on the video chip that has been installed on your computer.</li><li>6. Click the <b>Properties</b> button. If you are prompted for an administrator password or confirmation, type the password or provide confirmation. Check the "Device status" box and make sure the device is working properly. If not, click the <b>Troubleshoot</b> button.</li><li>7. Click the <b>Monitor</b> tab.</li><li>8. Make sure the information is correct.</li><li>9. Click the <b>Properties</b> button. If you are prompted for an administrator password or confirmation, type the password or provide confirmation. Check the "Device status" box and make sure the device is working properly. If not, click the <b>Troubleshoot</b> button.</li></ol>



**Solution (continued):****For Windows XP:**

1. Right-click on the desktop, click **Properties** to open the Display Properties window, then click the **Settings** tab.
2. Check whether the screen resolution and color quality are correctly set.
3. Click **Advanced**.
4. Click the **Adapter** tab.
5. Make sure the correct device driver name is shown in the adapter information window.  
**Note:** The device driver name depends on the video chip that has been installed on your computer.
6. Click the **Properties** button. Check the "Device status" box and make sure the device is working properly. If not, click the **Troubleshoot** button.
7. Click the **Monitor** tab.
8. Make sure the information is correct.
9. Click the **Properties** button. Check the "Device status" box and make sure the device is working properly. If not, click the **Troubleshoot** button.

**Problem:** A message, "Unable to create overlay window," appears when you try to start DVD playback.  
-or-  
You get poor or no playback while running video playback, DVD playback, or game applications.

**Solution:** Do either of the following:

- If you are using 32-bit color mode, change the color depth to 16-bit mode.
- If you are using a desktop size of 1280×1024 or larger, reduce the desktop size and the color depth.

**Battery problems**

**Problem:** The battery cannot be fully charged by the power-off method in the standard charge time for your computer.

**Solution:** For details, see the Battery and power category in Troubleshooting under the Problem solving section in *Access Help*.

## Solving computer problems

<b>Problem:</b>	Your computer shuts down before the battery status indicator shows empty, <b>-or-</b> Your computer operates after the battery status indicator shows empty.
<b>Solution:</b>	Discharge and recharge the battery.
<b>Problem:</b>	The operating time for a fully charged battery is short.
<b>Solution:</b>	For details, see the Battery and power category in Troubleshooting under the Problem solving section in <i>Access Help</i> .
<b>Problem:</b>	The computer does not operate with a fully charged battery.
<b>Solution:</b>	The surge protector in the battery might be active. Turn off the computer for one minute to reset the protector; then turn on the computer again.
<b>Problem:</b>	The battery does not charge.
<b>Solution:</b>	For details, see the Battery and power category in Troubleshooting under the Problem solving section in <i>Access Help</i> .

## Hard disk drive problems

<b>Problem:</b>	The hard disk drive does not work.
<b>Solution:</b>	In the startup menu in BIOS Setup Utility, make sure that the hard disk drive is included in the "Boot priority order" list. If it is included in the "Excluded from boot order" list, the hard disk drive is disabled. Select the entry for it in the list and press the x key. This moves the entry to the "Boot priority order" list.

<b>Problem:</b>	After setting a hard disk password on the hard disk drive of my computer, I moved the drive to another computer. Now I cannot unlock the hard disk password.
<b>Solution:</b>	Your computer supports an enhanced password algorithm. Computers older than yours may not support such a security function. If you have set a hard disk password with <b>Using Passphrase</b> enabled in the BIOS Setup Utility, and want to use the hard disk drive in an older computer, first remove the password, and then move the hard disk to the older computer.

<b>Problem:</b>	I cannot hot-swap the hard disk drive in the Ultrabay™.
<b>Solution:</b>	You can hot-swap a hard disk drive in the Ultrabay only if no hard disk password has been set. Make sure that the password for the hard disk drive in the Ultrabay is disabled.

<b>Problem:</b>	I cannot change or remove a hard disk password in the BIOS Setup Utility.
<b>Solution:</b>	The setting of <b>Using Passphrase</b> in the BIOS Setup Utility must be consistent between setting a hard disk password and changing or removing it. If the <b>Hard Disk x Password</b> menu in the BIOS Setup Utility is grayed out and unavailable, remove all other passwords. Then turn off your computer and uninstall the hard disk drive. Turn on the computer with the hard disk drive uninstalled, enter the BIOS Setup Utility, and set <b>Using Passphrase</b> as enabled or disabled, whichever was its setting when you set the password. Exit the BIOS Setup Utility, and turn off the computer. Replace the hard disk drive. Turn on the computer and enter the BIOS Setup Utility to change or remove the hard disk password.

## Fingerprint authentication problems

<b>Problem:</b>	You cannot register or authenticate your finger because it is wrinkled, rough, dry, injured, stained, oily, wet, or different one from what you have registered.
<b>Solution:</b>	To improve the situation, try the following: <ul style="list-style-type: none"><li>• Clean or wipe your hands to remove any excess dirt or moisture from the fingers.</li><li>• Enroll and use a different finger for authentication.</li><li>• If your hands are too dry, apply lotion to them.</li></ul>

## Startup problems

<b>Problem:</b>	The Microsoft® Windows operating system will not start.
<b>Solution:</b>	Use the Rescue and Recovery workspace to help solve or identify your problem. For details about Rescue and Recovery, see Chapter 4, "Recovery options," on page 29

## Other problems

<b>Problem:</b>	Your computer does not respond.
<b>Solution:</b>	<ul style="list-style-type: none"><li>• To turn off your computer, press and hold the power switch for 4 seconds or more. If the computer still does not respond, remove the ac adapter and the battery.</li><li>• Your computer might lock when it enters sleep (standby) mode during a communication operation. Disable the sleep (standby) timer when you are working on the network.</li></ul>
<b>Problem:</b>	The computer does not start from a device you want.
<b>Solution:</b>	<p>See the Startup menu of the BIOS Setup Utility. Make sure that the startup sequence in the BIOS Setup Utility is set so that the computer starts from the device you want.</p> <p>Also make sure that the device from which the computer starts is enabled. In the startup menu in the BIOS Setup Utility, make sure that the device is included in the "Boot priority order" list. If it is included in the "Excluded from boot order" list, it is disabled. Select the entry for it in the list and press the x key. This moves the entry to the "Boot priority order" list.</p>

---

## Starting BIOS Setup Utility

Your computer provides a program, called BIOS Setup Utility, that enables you to select various setup parameters.

- Config: Set the configuration of your computer.
- Date/Time: Set the date and time.
- Security: Set security features.
- Startup: Set the startup device.
- Restart: Restart the system.

To start BIOS Setup Utility, do as follows:

1. To protect yourself against accidental loss of data, back up your data and computer registry. For details see the "Data backup-and-restore tools" section of *Access Help*.
2. If the diskette drive is connected to the computer, remove any diskette from the diskette drive, and then turn off the computer.
3. Turn on the computer; then, while the message, "To interrupt normal startup, press the blue ThinkVantage button" is displayed at the lower left of the screen, press the ThinkVantage button. The Rescue and Recovery workspace opens.

4. Click **Access BIOS**. The System Restart Required window is displayed.
5. Click **Yes**. The computer restarts, and the BIOS Setup Utility menu appears.

If you have set a supervisor password, the BIOS Setup Utility menu appears after you enter the password. You can start the utility by pressing Enter instead of entering the supervisor password; however, you cannot change the parameters that are protected by the supervisor password. For more information, see the on-board help.

6. Using the cursor keys, move to an item you want to change. When the item you want is highlighted, press Enter. A submenu is displayed.
7. Change the items you wish to change. To change the value of an item, use the F5 or F6 key. If the item has a submenu, you can display it by pressing Enter.
8. Press F3 or Esc to exit from the submenu. If you are in a nested submenu, press Esc repeatedly until you reach the **BIOS Setup Utility** menu.

**Note:** If you need to restore the settings to their original state as of the time of purchase, press F9 key to load the default settings. You can also select an option in the Restart submenu to load the default settings or discard the changes.

9. Select **Restart**; then press Enter. Move the cursor to the option you want for restarting your computer; then press Enter. Your computer restarts.

*Starting BIOS Setup Utility*

---

## Chapter 4. Recovery options

---

### Introducing Rescue and Recovery

If Windows is not running properly, use the Rescue and Recovery workspace to help solve or identify your problem. Do the following:

1. Turn off your PC, then turn it on again.
2. Watch the screen carefully while your PC starts. When “To interrupt normal startup, press the blue ThinkVantage button” message is displayed at the lower left of the screen, press the blue ThinkVantage button. The Rescue and Recovery workspace opens.
3. After the Rescue and Recovery workspace opens, you can do the following:
  - Rescue and Restore your files, folders, or backups.
  - Configure your system settings and passwords.
  - Communicate using the internet and link to the support site.
  - Troubleshoot and diagnose problems using diagnostics.

For more information about using Rescue and Recovery features, see the “Recovery overview” section of the *Access Help*.

---

### Restoring factory contents

Instead of providing a recovery disc or a Windows disc with your computer, Lenovo provides simpler methods of accomplishing the tasks typically associated with these discs. The files and programs for these alternative methods are on your hard disk, which eliminates having to locate a misplaced disc and problems associated with using an incorrect version of the disc.

The complete backup of all the files and programs that Lenovo preinstalled on your computer resides in a hidden protected area, or partition, of the hard disk. Although hidden, the backups in the partition consume hard disk space. Therefore, when checking the capacity of your hard disk according to Windows, you might note that the total capacity of the disk appears to be smaller than anticipated. This discrepancy is explained by the contents of the hidden partition.

The Product Recovery Program contained within this area enables you to restore the complete contents of your hard disk to the same state as it was when originally shipped from the factory.

To recover the hard disk to its original contents, do the following:

## Recovery options

### Notes:

1. If you are using Windows XP, and the optical drive is not attached to your ThinkPad computer during recovery, DVD software and CD-recording software will not be installed. To ensure that they will be installed correctly, attach your ThinkPad computer to the ThinkPad X6 Tablet UltraBase™ and install the optical drive in the Ultrabay Slim before performing a recovery operation.
2. The recovery process might take up to 2 hours.

**Attention:** All of the files on the primary hard disk partition (usually drive C) will be lost in the recovery process. However, before any data is overwritten, you will be given the opportunity to save one or more files to other media.

1. If possible, save all your files and shut down your operating system.
2. Turn off your computer for at least 5 seconds.
3. Turn on your computer. Watch the display carefully. While the message, "To interrupt normal startup, press the blue ThinkVantage button" is displayed, press the ThinkVantage button. The Rescue and Recovery workspace opens.
4. Click **Restore your system** and follow the instructions on the screen.

---

## Recovering data

If you performed a backup operation using the Rescue and Recovery program, you also have one or more backups stored that reflect the contents of the hard disk as it existed at various points in time. These backups might be stored on your hard disk, or a network drive, or on removable media, depending on the options you selected during the backup operation.

You can use either the Rescue and Recovery program or the Rescue and Recovery workspace to restore the contents of the hard disk to an earlier state using any of the stored backups. The Rescue and Recovery workspace runs independently of the Windows operating system. Therefore, you can start it by pressing the blue ThinkVantage button when prompted during startup.

After the Rescue and Recovery workspace opens you can perform a recovery operation, even if you are unable to start Windows.



---

## Chapter 5. Upgrading and replacing devices

---

### Replacing the battery

**Important**

Read *Safety and Warranty Guide* before replacing the battery.

1. **Turn off the computer, or enter hibernation mode.** Then disconnect the ac adapter and all cables from the computer.

**Note:** If you are using a PC Card or Secure Digital Card, the computer might not be able to enter hibernation mode. If this happens, turn off the computer.

2. Close the computer display, and turn the computer over.
3. Slide the battery lock to the unlocked position.

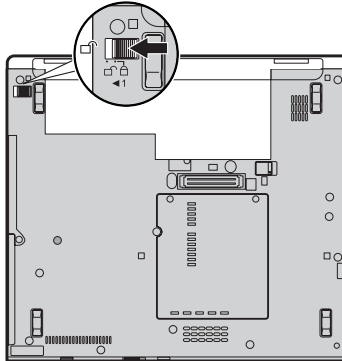

## Replacing the battery

4. Slide and hold the battery latch **1**. Then, remove the battery **2**.

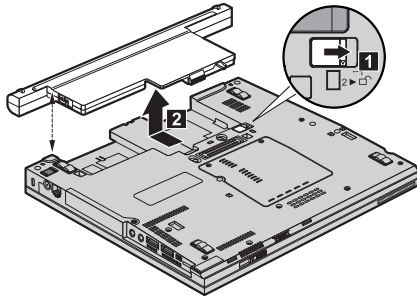

5. Install a fully charged battery.

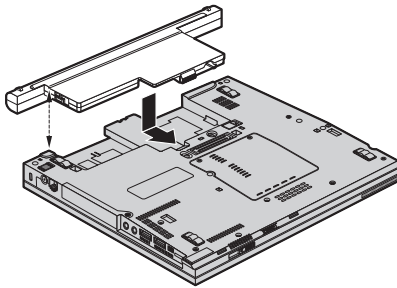

6. Slide the battery lock to the locked position.

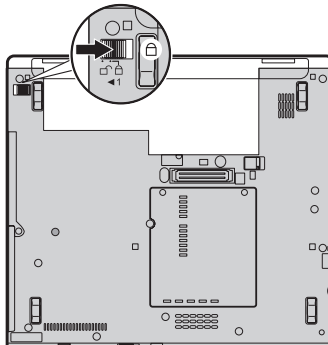

7. Turn the computer over again. Connect the ac adapter and the cables to the computer.

**Note:** Your battery may appear slightly different from those shown in figures above depending on the model.

---

## Upgrading the hard disk drive

### Important

Read *Safety and Warranty Guide* before replacing the hard disk drive.

You can increase the storage capacity of your computer by replacing the hard disk drive with one of greater capacity. You can purchase a new hard disk drive from your reseller or Lenovo marketing representative.

### Notes:

1. Replace the hard disk drive only if you upgrade it or have it repaired. The connectors and bay of the hard disk drive were not designed for frequent changes, or drive swapping.
2. The Rescue and Recovery workspace and the Product Recovery program are not included on an optional hard disk drive.

### Attention

#### Handling a hard disk drive

- Do not drop the drive or subject it to physical shocks. Put the drive on a material, such as soft cloth, that absorbs the physical shock.
- Do not apply pressure to the cover of the drive.
- Do not touch the connector.

The drive is very sensitive. Incorrect handling can cause damage and permanent loss of data on the hard disk. Before removing the hard disk drive, make a backup copy of all the information on the hard disk, and then turn the computer off. Never remove the drive while the system is operating, in standby mode, or in hibernation mode.

To replace the hard disk drive, do the following:

1. **Turn off the computer;** then disconnect the ac adapter and all cables from the computer.
2. Close the computer display, and turn the computer over.
3. Remove the battery.

## Upgrading the hard disk drive

4. Remove the screw **1** that secures the hard disk drive slot cover. Then, flip out and remove the cover **2**.

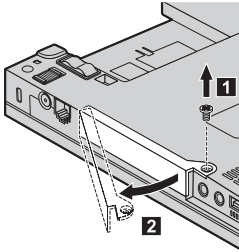

5. Remove the hard disk drive by pulling out the tab.

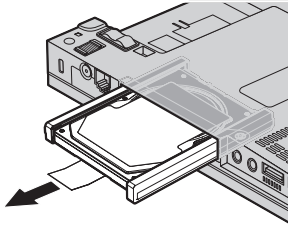

6. Detach the side rubber rails from the hard disk drive.

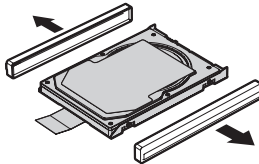

7. Attach the side rubber rails to a new hard disk drive.
8. Insert the hard disk drive into the hard disk drive bay; then press it firmly in to place.

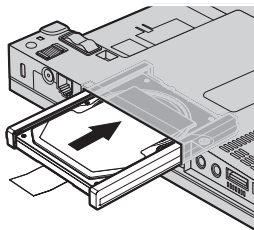

9. Insert **1** and reinstall the cover of the hard disk drive slot **2**. Then, reinstall the screw **3**.

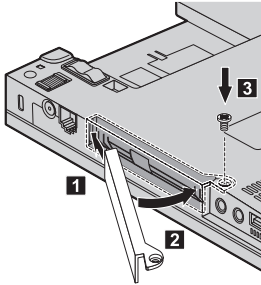

10. Reinstall the battery.
11. Turn the computer over again. Connect the ac adapter and the cables to the computer.

---

## Replacing memory

### Important

Read *Safety and Warranty Guide* before replacing memory.

Increasing memory capacity is an effective way to make programs run faster. You can increase the amount of memory in your computer by installing a double data rate (DDR) 2 synchronous dynamic random access memory (DRAM) unbuffered small outline dual inline memory module (SO-DIMM), available as an option, in the memory slot of your computer. SO-DIMMs with different capacities are available.

**Note:** Use only the memory types supported by your computer. If you incorrectly install the optional memory or install an unsupported memory type, a warning beep will sound when you try to start the computer.

To install an SO-DIMM, do the following:

1. Touch a metal table or a grounded metal object. This action reduces any static electricity in your body, which could damage the SO-DIMM. Do not touch the contact edge of the SO-DIMM.
2. **Turn off the computer;** then disconnect the ac adapter and all cables from the computer.
3. Close the computer display, and turn the computer over.

## Replacing memory

4. Remove the battery.
5. Loosen the screws that hold the memory-slot cover in place **1**; then remove the cover **2**.

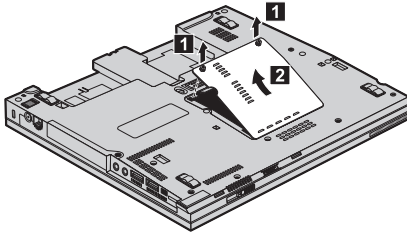

6. If two SO-DIMMs are already installed in the memory slot, remove one of them to make room for the new one by pressing out on the latches on both edges of the socket at the same time. Be sure to save the old SO-DIMM for future use.

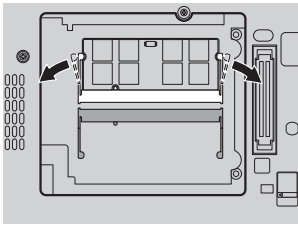

7. With the notched end of the SO-DIMM toward the contact edge side of the socket, firmly insert the SO-DIMM into the socket at an angle of about 20 degrees **1**; then pivot it downward until it snaps into place **2**.

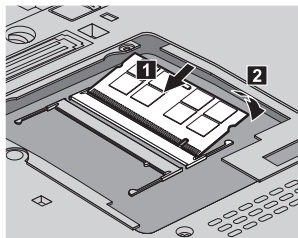

8. Reinstall the memory-slot cover and tighten the screws
9. Reinstall the battery.
10. Turn the computer over, and reconnect the ac adapter and the cables to the computer.

To make sure that the SO-DIMM is installed correctly, do as follows:

1. Turn the computer on.
2. While the “To interrupt normal startup, press the blue ThinkVantage button” message is displayed at the lower left of the screen, press the ThinkVantage button. The Rescue and Recovery screen opens.
3. Click **Access BIOS**. The System Restart Required window is displayed.
4. Click **Yes**. The computer restarts, and the BIOS Setup Utility screen opens. The “Installed memory” item shows the total amount of memory installed in your computer.

## *Replacing memory*



---

## Chapter 6. Getting help and service

---

### Getting help and service

If you need help, service, technical assistance, or just want more information about ThinkPad computers, you will find a wide variety of sources available from Lenovo to assist you. This section contains information about where to go for additional information about ThinkPad computers, what to do if you experience a problem with your computer, and whom to call for service should it be necessary.

Microsoft Service Packs are the latest software source for Windows product updates. They are available via Web download (connection charges may apply) or via a disc. For more specific information and links, please go to the Microsoft Web site at <http://www.microsoft.com>. Lenovo offers Up and Running technical assistance with installation of, or questions related to, Service Packs for your Lenovo-preinstalled Microsoft Windows product. For information, please contact the Customer Support Center at the phone number(s) listed in “Worldwide telephone list” on page 41. Some fees might apply.

---

### Getting help on the Web

The Lenovo Web site on the World Wide Web has up-to-date information about ThinkPad computers and support. The address for the Personal Computing home page is <http://www.lenovo.com/think>.

You can find support information for your ThinkPad computer at <http://www.lenovo.com/think/support>. Research this Web site to learn how to solve problems, find new ways to use your computer, and learn about options that can make working with your ThinkPad computer even easier.

---

### Calling the Customer Support Center

If you have tried to correct the problem yourself and still need help, during the warranty period, you can get help and information by telephone through the Customer Support Center. The following services are available during the warranty period:

- Problem determination - Trained personnel are available to assist you with determining if you have a hardware problem and deciding what action is necessary to fix the problem.

## Getting help and service

- Lenovo hardware repair - If the problem is determined to be caused by Lenovo hardware under warranty, trained service personnel are available to provide the applicable level of service.
- Engineering change management - Occasionally, there might be changes that are required after a product has been sold. Lenovo or your reseller, if authorized by Lenovo, will make selected Engineering Changes (ECs) available that apply to your hardware.

The following items are not covered:

- Replacement or use of parts not manufactured for or by Lenovo or nonwarranted parts

**Note:** All warranted parts contain a 7-character identification in the format FRU XXXXXXX

- Identification of software problem sources
- Configuration of BIOS as part of an installation or upgrade
- Changes, modifications, or upgrades to device drivers
- Installation and maintenance of network operating systems (NOS)
- Installation and maintenance of application programs

To determine if your machine is in warranty and when the warranty expires, go to <http://www.lenovo.com/think/support>, and click **Warranty**, then follow the instructions on the screen.

For the terms and conditions of the Lenovo Limited Warranty that applies to your Lenovo hardware product, see Chapter 3, Warranty Information in the *Safety and Warranty Guide* included with your Lenovo hardware product.

If possible, be near your computer when you make your call in case the technical assistance representative needs to help you resolve a computer problem. Please ensure that you have downloaded the most current drivers and system updates, run diagnostics, and recorded information before you call. When calling for technical assistance, please have the following information available:

- Machine Type and Model
- Serial numbers of your computer, monitor, and other components, or your proof of purchase
- Description of the problem
- Exact wording of any error messages
- Hardware and software configuration information for your system

The telephone numbers for your Customer Support Center location are located in the Worldwide telephone list section of this guide.

**Note:** Telephone numbers are subject to change without notice. For the latest list of Customer Support Center telephone numbers and hours of

operation, visit the Support Web site at <http://www.lenovo.com/support/phone>. If the number for your country or region is not listed, contact your Lenovo reseller or Lenovo marketing representative.

---

## Getting help around the world

If you travel with your computer or relocate it to a country where your ThinkPad machine type is sold, your computer might be eligible for International Warranty Service, which automatically entitles you to obtain warranty service throughout the warranty period. Service will be performed by service providers authorized to perform warranty service.

Service methods and procedures vary by country, and some services might not be available in all countries. International Warranty Service is delivered through the method of service (such as depot, carry-in, or on-site service) that is provided in the servicing country. Service centers in certain countries might not be able to service all models of a particular machine type. In some countries, fees and restrictions might apply at the time of service.

To determine whether your computer is eligible for International Warranty Service and to view a list of the countries where service is available, go to <http://www.lenovo.com/think/support>, click **Warranty**, and follow the instructions on the screen.

---

## Worldwide telephone list

Phone numbers are subject to change without notice. For the most current phone numbers, go to <http://www.lenovo.com/support/phone>.

Country or Region	Telephone Number
Africa	Africa: +44 (0)1475-555-055 South Africa: +27-11-3028888 and 0800110756 Central Africa: Contact the nearest Lenovo Business Partner
Argentina	0800-666-0011 (Spanish)
Australia	131-426 (English)
Austria	01-24592-5901 (30 day up and running support) 01-211-454-610 (Warranty service and support) (German)
Belgium	02-210-9820 (30 day up and running support) (Dutch) 02-210-9800 (30 day up and running support) (French) 02-225-3611 (Warranty service and support) (Dutch, French)
Bolivia	0800-10-0189 (Spanish)

## Getting help and service

Country or Region	Telephone Number
Brazil	Sao Paulo region: (11) 3889-8986 Outside Sao Paulo region: 0800-701-4815 (Brazilian Portuguese)
Canada	1-800-565-3344 (English, French) In Toronto only call 416-383-3344
Chile	800-361-213 188-800-442-488 (Toll free) (Spanish)
China	Technical Support Line 800-990-8888 86-10-58851110 (Mandarin)
China (Hong Kong S.A.R.)	ThinkPad (Technical enquiry hotline): 2516-3939 (Hong Kong) 0800-839 (Macau) ThinkPad Service Center: 2825-6580 (Hong Kong) 715-399 (Macau) Multimedia Home PC: 800-938-228 (Hong Kong) 0800-336 (Macau) (Cantonese, English, Mandarin)
China (Macau S.A.R.)	ThinkPad (Technical enquiry hotline): 0800-839 (Cantonese, English, Mandarin)
Colombia	1-800-912-3021 (Spanish)
Costa Rica	800-011-1029 (Spanish)
Croatia	0800-0426
Cyprus	+357-22-841100
Czech Republic	+420-2-7213-1316
Denmark	4520-8200 (30 day up and running support) 7010-5150 (Warranty service and support) (Danish)
Dominican Republic	1-866-434-2080 (Spanish)
Ecuador	1-800-426911 (Spanish)
El Salvador	800-6264 (Spanish)
Estonia	+372 66 00 800 +372 6776793
Finland	09-459-6960 (30 day up and running support) +358-800-1-4260 (Warranty service and support) (Finnish)

Country or Region	Telephone Number
France	Hardware 0810-631-213 (Warranty service and support) Software 0810-631-020 (Warranty service and support) 0238-557-450 (30 day up and running support) (French)
Germany	07032-15-49201 (30 day up and running support) 01805-25-35-58 (Warranty service and support) (German)
Greece	+30-210-680-1700
Guatemala	1800-624-0051 (Spanish)
Honduras	Tegucigalpa: 232-4222 San Pedro Sula: 552-2234 (Spanish)
Hungary	+36-1-382-5720
India	1800-425-6666 or +91-80-2678-8970 (English)
Indonesia	800-140-3555 (English) 62-21-251-2955 (Bahasa, Indonesian)
Ireland	01-815-9202 (30 day up and running support) 01-881-1444 (Warranty service and support) (English)
Israel	Givat Shmuel Service Center: +972-3-531-3900 (Hebrew, English)
Italy	02-7031-6101 (30 day up and running support) +39-800-820094 (Warranty service and support) (Italian)
Japan	ThinkPad Products Toll Free: 0120-20-5550 International: +81-46-266-4716  Both of the above numbers will be answered with a Japanese language voice prompt. For telephone support in English, please wait for the Japanese voice prompt to end, and an operator will answer. Please say "English support please," and your call will be transferred to an English speaking operator.
Korea	1588-5801 (Korean)
Latvia	+371 7070360
Lithuania	+370 5 278 66 00
Luxembourg	+352-298-977-5063 (French)
Malaysia	1800-88-8558 (English, Bahasa, Melayu)

## Getting help and service

Country or Region	Telephone Number
Malta	+35621445566
Mexico	001-866-434-2080 (Spanish)
Middle East	+44 (0)1475-555-055
Netherlands	+31-20-514-5770 (Dutch)
New Zealand	0800-733-222 (English)
Nicaragua	001-800-220-1830 (Spanish)
Norway	6681-1100 (30 day up and running support) 8152-1550 (Warranty service and support) (Norwegian)
Panama	206-6047 001-866-434-2080 (Lenovo Customer Support Center- toll Free) (Spanish)
Peru	0-800-50-866 (Spanish)
Philippines	1800-1888-1426 (English) 63-2-995-8420 (Filipino)
Poland	+48-22-878-6999
Portugal	+351-21-892-7147 (Portuguese)
Romania	+4-021-224-4015
Russian Federation	Moscow: +7 (495) 258-6300 Toll free: 8 800 200 6300 (Russian)
Singapore	1800-3172-888 (English, Bahasa, Melayu)
Slovakia	+421-2-4954-5555
Slovenia	+386-1-4796-699
Spain	91-714-7983 0901-100-000 (Spanish)
Sri Lanka	+9411 2493547 +9411 2493548 (English)
Sweden	08-477-4420 (30 day up and running support) 077-117-1040 (Warranty service and support) (Swedish)
Switzerland	058-333-0900 (30 day up and running support) 0800-55-54-54 (Warranty service and support) (German, French, Italian)

<b>Country or Region</b>	<b>Telephone Number</b>
Taiwan	886-2-8723-9799 or 0800-000-700 (Mandarin)
Thailand	1-800-299-229 (Thai)
Turkey	00800-4463-2041 (Turkish)
United Kingdom	01475-555-055 (30 day up and running support) 08705-500-900 (Standard warranty support) (English)
United States	1-800-426-7378 (English)
Uruguay	000-411-005-6649 (Spanish)
Venezuela	0-800-100-2011 (Spanish)
Vietnam	For northern area and Hanoi: 84-4-843-6675 For southern area and Ho Chi Minh City: 84-8-829-5160 (English, Vietnamese)





## Appendix A. Warranty information

This Appendix provides information regarding the warranty period and type of warranty service applicable to your Lenovo hardware product in your country or region. For the terms and conditions of the Lenovo Limited Warranty that applies to your Lenovo hardware product, see Chapter 3, Warranty Information in the *Safety and Warranty Guide* included with your Lenovo hardware product.

Machine Type	Country or Region of Purchase	Warranty period	Types of Warranty Service
7762	US, Canada, Mexico, Brazil, and Australia	Parts and Labor - 3 years Battery pack and Tablet Digitizer Pen - 1 year	3 1
	Latin America, EMEA (Europe, Middle East, and Africa), and AP (Asia Pacific)	Parts and Labor - 3 years Battery pack and Tablet Digitizer Pen - 1 year	4 1
	Japan	Parts and Labor - 1 year Battery pack and Tablet Digitizer Pen - 1 year	3 1
7763	All	Parts and Labor - 3 years	2
		Battery pack and Tablet Digitizer Pen - 1 year	1
7764	US and Canada	Parts and Labor - 1 year	3
		Battery pack and Tablet Digitizer Pen - 1 year	1
7767	US and Canada	Parts and Labor - 3 years	3
		Battery pack and Tablet Digitizer Pen - 1 year	1

Machine Type	Country or Region of Purchase	Warranty period	Types of Warranty Service
7768	US, Canada, Mexico, Brazil, Australia, and Japan	Parts and Labor - 4 years	3
		Battery pack and Tablet Digitizer Pen - 1 year	1
	Latin America, EMEA, and AP	Parts and Labor - 4 years	4
		Battery pack and Tablet Digitizer Pen - 1 year	1
7769	All	Parts and Labor - 4 years	2
		Battery pack and Tablet Digitizer Pen - 1 year	1

**Note:** Your ThinkPad X61 Tablet computer is shipped with five replacement tips for the X61 Tablet Digitizer Pen. Be sure to store the pen tips in a secure place for future use. The pen tips will not be covered under the digitizer pen or computer warranty.

---

## Types of warranty service

### 1. Customer Replaceable Unit ("CRU") Service

Under CRU Service, your Service Provider will ship CRUs to you for you to install. Most CRUs are easy to install whereas others may require some technical skill and tools. CRU information and replacement instructions are shipped with your product and are available from Lenovo at any time upon request. You may request that a Service Provider install some CRUs under one of the other types of warranty service designated for your product. Installation of external CRUs (such as mice, keyboards, or monitors) is your responsibility. Lenovo specifies in the materials shipped with a replacement CRU whether the defective CRU must be returned. When return is required, 1) return instructions, a prepaid return shipping label, and a container are included with the replacement CRU, and 2) you may be charged for the replacement CRU if your Service Provider does not receive the defective CRU within thirty (30) days of your receipt of the replacement.

### 2. On-site Service

Under On-Site Service, your Service Provider will either repair or exchange the product at your location. You must provide a suitable working area to allow disassembly and reassembly of the Lenovo product. For some products, certain repairs may require your Service Provider to send the product to a designated service center.

### **3. Courier or Depot Service**

Under Courier or Depot Service, your product will be repaired or exchanged at a designated service center, with shipping arranged by your Service Provider. You are responsible for disconnecting the product. A shipping container will be provided to you for you to return your product to a designated service center. A courier will pick up your product and deliver it to the designated service center. Following its repair or exchange, the service center will arrange the return delivery of the product to you.

### **4. Customer Carry-In or Mail-In Service**

Under Customer Carry-In or Mail-In Service, your product will be repaired or exchanged at a designated service center, with delivery or shipping arranged by you. You are responsible to deliver or mail, as your Service Provider specifies, (prepaid unless specified otherwise) the product suitably packaged to a designated location. After the product has been repaired or exchanged, it will be made available for your collection. Failure to collect the product may result in your Service Provider disposing of the product as it sees fit. For Mail-in Service, the product will be returned to you at Lenovo's expense, unless your Service Provider specifies otherwise.



---

## Appendix B. Customer Replaceable Units (CRUs)

Customer Replaceable Units (CRUs) are computer parts that can be upgraded or replaced by the customer. There are two types of CRUs: *internal* and *external*. External CRUs are easy to install, whereas internal CRUs require some technical skills and in some cases might require tools such as a screwdriver. However, both internal and external CRUs are safe for removal by the customer.

Customers are responsible for replacing all external CRUs. Internal CRUs can be removed and installed by customers or by a Lenovo service technician during the warranty period.

Your computer contains the following types of external CRUs:

- **External CRUs (pluggable):** These CRUs unplug from the computer. Examples of these types of CRUs include the ac adapter and power cord.
- **External CRUs with latches:** These CRUs include a latch to help you remove and replace the part. Examples of these types of CRUs include the notebook main battery and Ultrabay devices such as an optical drive, a hard-disk drive, and an extended battery.

Your computer contains the following types of internal CRUs:

- **Internal CRUs (located behind an access panel):** These CRUs are isolated parts within the computer that are concealed by an access panel that is typically secured by either one or two screws. Once the access panel is removed, only the specific CRU is visible. Examples of these types of CRUs include memory modules and hard disk drives.
- **Internal CRUs (located within the product):** These CRUs are accessible only by opening the computer's outer case. Examples of these CRUs include PCI Express Mini Cards and the integrated keyboard.

Online *Access Help* provides instructions for replacing internal and external CRUs. To start the Access Help program, click **Start**, move the pointer to **All Programs**; then to **ThinkVantage**. Click **Access Help**.

Additionally, the Service and Troubleshooting Guide (this guide) and *Setup Instructions* provide instructions for several critical CRUs.

If you are unable to access these instructions or if you have difficulty replacing a CRU, you can use either of the following additional resources:

- The Online Hardware Maintenance Manual and Online Videos available from the Support Web site  
<http://www.lenovo.com/support/site.wss/document.do?sitestyle=lenovo&Indocid=part-video>.
- The Customer Support Center. For the telephone number of the Support Center for your country or region, see “Worldwide telephone list” on page 41.

**Note: Only use computer parts provided by Lenovo. See Chapter 3, Warranty Information in the *Safety and Warranty Guide* for warranty information about the CRUs for your machine type.**

The following table provides a list of CRUs for your computer and where to locate the replacement instructions.

	Service and Troubleshooting Guide	Setup Instructions	Access Help	Online Hardware Maintenance Manual	Online Video
<b>External CRUs (pluggable)</b>					
AC adapter		X			
Power cord for ac power adapter		X			
TrackPoint cap			X		
Tablet Digitizer Pen			X		
<b>External CRUs (with latches)</b>					
Battery	X		X	X	X
Snap-on bracket			X	X	X
<b>Internal CRUs (behind an access panel)</b>					
Hard disk drive	X		X	X	X
Memory	X		X	X	X
<b>Internal CRUs (located within the product)</b>					
Keyboard			X	X	X
Palm rest			X	X	X
PCI Express Mini Card			X	X	X

	<b>Service and Troubleshooting Guide</b>	<b>Setup Instructions</b>	<b>Access Help</b>	<b>Online Hardware Maintenance Manual</b>	<b>Online Video</b>
Communication Daughter Card			X	X	X





---

## Appendix C. Features and Specifications

---

### Features

#### Processor

- See the system properties of your computer. You can do this as follows:  
Click **Start**, right-click **Computer** (in Windows XP, **My Computer**); then from the pull down menu select **Properties**.

#### Memory

- Double data rate (DDR) 2 synchronous dynamic random access memory

#### Storage device

- 2.5-inch hard disk drive

#### Display

The color display uses TFT technology:

- Size: 12.1 inch screen  
Resolution:
  - LCD: 1024-by-768 or 1400-by-1050
  - External monitor: Up to 2048-by-1536
- Brightness control
- Fingerprint reader (on some models)

#### Keyboard

- 89-key, 90-key, or 94-key
- TrackPoint
- Fn key function
- ThinkVantage button
- Volume control buttons

#### Interface

- External-monitor connector
- Stereo headphone jack
- Microphone jack
- 3 Universal Serial Bus (USB) connectors
- IEEE 1394 connector (on some models)
- RJ11 telephone connector
- RJ45 Ethernet connector
- Ultrabay Slim (in optional ThinkPad X6 Tablet UltraBase)
- Docking connector

## Features

### PC Card slot

- Type II PC Card

### Optical drive

- CD-ROM, DVD-ROM, Combo or Multi-Burner drive in optional ThinkPad X6 Tablet UltraBase depending on the model

### Wireless features

- Integrated wireless LAN (on some models)
- Integrated *Bluetooth* (on some models)
- Integrated wireless WAN (on some models)

### Digital media reader

- Secure Digital (SD) card slot

---

## Specifications

### Size

- Width: 274 mm
- Depth: 241.3 to 266.7 mm depending on the battery type
- Height: 25.4 to 33.0 mm

### Environment

- Maximum altitude without pressurization: 3048 m (10,000 ft)
- Temperature
  - At altitudes up to 2438 m (8000 ft)
    - Operating: 5°C to 35°C (41°F to 95°F)
    - Non-operating: 5°C to 43°C (41°F to 109°F)
  - At altitudes above 2438 m (8000 ft)
    - Maximum temperature when operating under the unpressurized condition: 31.3°C (88° F)

**Note:** When you charge the battery pack, its temperature must be at least 10°C (50°F).

- Relative humidity:
  - Operating: 8% to 80%
  - Non-operating: 5% to 95%

### Heat output

- 65 W (222 Btu/hr) maximum

### Power source (ac adapter)

- Sine-wave input at 50 to 60 Hz
- Input rating of the ac adapter: 100-240 V ac, 50 to 60 Hz

**Battery pack**

- ThinkPad X60 Tablet 4 Cell Lithium-ion (Li-Ion) battery pack
  - Nominal voltage: 14.4 V dc
  - Capacity: 2.0 AH
- ThinkPad X60 Tablet 8 Cell Lithium-ion (Li-Ion) battery pack
  - Nominal voltage: 14.4 V dc
  - Capacity: 4.55 AH

**Battery life**

- For percentage of remaining battery power, see the Power Manager Gauge on the task tray.

**Operating system**

- For operating systems supporting your computer, see <http://www.lenovo.com/think/support>.

*Specifications*

---

## Appendix D. Notices

---

### Notices

Lenovo may not offer the products, services, or features discussed in this document in all countries. Consult your local Lenovo representative for information on the products and services currently available in your area. Any reference to a Lenovo product, program, or service is not intended to state or imply that only that Lenovo product, program, or service may be used. Any functionally equivalent product, program, or service that does not infringe any Lenovo intellectual property right may be used instead. However, it is the user's responsibility to evaluate and verify the operation of any other product, program, or service.

Lenovo may have patents or pending patent applications covering subject matter described in this document. The furnishing of this document does not give you any license to these patents. You can send license inquiries, in writing, to:

*Lenovo (United States), Inc.  
1009 Think Place - Building One  
Morrisville, NC 27560  
U.S.A.  
Attention: Lenovo Director of Licensing*

LENOVO PROVIDES THIS PUBLICATION "AS IS" WITHOUT WARRANTY OF ANY KIND, EITHER EXPRESS OR IMPLIED, INCLUDING, BUT NOT LIMITED TO, THE IMPLIED WARRANTIES OF NON-INFRINGEMENT, MERCHANTABILITY OR FITNESS FOR A PARTICULAR PURPOSE. Some jurisdictions do not allow disclaimer of express or implied warranties in certain transactions, therefore, this statement may not apply to you.

This information could include technical inaccuracies or typographical errors. Changes are periodically made to the information herein; these changes will be incorporated in new editions of the publication. Lenovo may make improvements and/or changes in the product(s) and/or the program(s) described in this publication at any time without notice.

The products described in this document are not intended for use in implantation or other life support applications where malfunction may result in injury or death to persons. The information contained in this document does not affect or change Lenovo product specifications or warranties. Nothing in this document shall operate as an express or implied license or indemnity under the intellectual property rights of Lenovo or third parties. All

information contained in this document was obtained in specific environments and is presented as an illustration. The result obtained in other operating environments may vary.

Lenovo may use or distribute any of the information you supply in any way it believes appropriate without incurring any obligation to you.

Any references in this publication to non-Lenovo Web sites are provided for convenience only and do not in any manner serve as an endorsement of those Web sites. The materials at those Web sites are not part of the materials for this Lenovo product, and use of those Web sites is at your own risk.

Any performance data contained herein was determined in a controlled environment. Therefore, the result obtained in other operating environments may vary significantly. Some measurements may have been made on development-level systems and there is no guarantee that these measurements will be the same on generally available systems. Furthermore, some measurements may have been estimated through extrapolation. Actual results may vary. Users of this document should verify the applicable data for their specific environment.

---

## Electronic emissions notices

The following information refers to ThinkPad X61 Tablet, machine type 7762, 7763, 7764, 7767, 7768, and 7769.

### **Federal Communications Commission (FCC) Statement**

This equipment has been tested and found to comply with the limits for a Class B digital device, pursuant to Part 15 of the FCC Rules. These limits are designed to provide reasonable protection against harmful interference in a residential installation. This equipment generates, uses, and can radiate radio frequency energy and, if not installed and used in accordance with the instructions, may cause harmful interference to radio communications. However, there is no guarantee the interference will not occur in a particular installation. If this equipment does cause harmful interference to radio or television reception, which can be determined by turning the equipment off and on, the user is encouraged to try to correct the interference by one or more of the following measures:

- Reorient or relocate the receiving antenna.
- Increase the separation between the equipment and receiver.
- Connect the equipment into an outlet on a circuit different from that to which the receiver is connected.
- Consult an authorized dealer or service representative for help.

Properly shielded and grounded cables and connectors must be used in order to meet FCC emission limits. Proper cables and connectors are available from Lenovo authorized dealers. Lenovo is not responsible for any radio or television interference caused by using other than recommended cables or connectors or by unauthorized changes or modifications to this equipment. Unauthorized changes or modifications could void the user's authority to operate the equipment.

This device complies with Part 15 of the FCC Rules. Operation is subject to the following two conditions: (1) this device may not cause harmful interference, and (2) this device must accept any interference received, including interference that may cause undesired operation.

Responsible party:

Lenovo (United States) Incorporated  
1009 Think Place - Building One  
Morrisville, NC 27560  
Telephone: 1-919-294-5900



### **Industry Canada Class B emission compliance statement**

This Class B digital apparatus complies with Canadian ICES-003.

### **Avis de conformité à la réglementation d'Industrie Canada**

Cet appareil numérique de la classe B est conforme à la norme NMB-003 du Canada.

### **European Union EMC Directive conformance statement**

This product is in conformity with the protection requirements of EU Council Directive 89/336/EEC on the approximation of the laws of the Member States relating to electromagnetic compatibility. Lenovo cannot accept responsibility for any failure to satisfy the protection requirements resulting from a nonrecommended modification of the product, including the fitting of non-Lenovo option cards.

This product has been tested and found to comply with the limits for Class B Information Technology Equipment according to CISPR 22/European Standard EN 55022. The limits for Class B equipment were derived for typical residential environments to provide reasonable protection against interference with licensed communication devices.

Properly shielded and grounded cables and connectors must be used in order to reduce the potential for causing interference to radio and TV

communications and to other electrical or electronic equipment. Such cables and connectors are available from Lenovo authorized dealers. Lenovo cannot accept responsibility for any interference caused by using other than recommended cables and connectors.

### Japanese VCCI Class B statement

この装置は、情報処理装置等電波障害自主規制協議会（VCCI）の基準に基づくクラスB情報技術装置です。この装置は、家庭環境で使用することを目的としていますが、この装置がラジオやテレビジョン受信機に近接して使用されると、受信障害を引き起こすことがあります。

取扱説明書に従って、正しい取り扱いをして下さい。

---

### EU WEEE Statements

The Waste Electrical and Electronic Equipment (WEEE) mark applies only to countries within the European Union (EU) and Norway. Appliances are labeled in accordance with European Directive 2002/96/EC concerning waste electrical and electronic equipment (WEEE). The Directive determines the framework for the return and recycling of used appliances as applicable throughout the European Union. This label is applied to various products to indicate that the product is not to be thrown away, but rather reclaimed upon end of life per this Directive.

Users of electrical and electronic equipment (EEE) with the WEEE marking per Annex IV of the WEEE Directive must not dispose of end of life EEE as unsorted municipal waste, but use the collection framework available to them for the return, recycle, recovery of WEEE and minimize any potential effects of EEE on the environment and human health due to the presence of hazardous substances. For additional WEEE information go to:  
<http://www.lenovo.com/lenovo/environment>.

---

### Notice for users in the U.S.A.

California Perchlorate Information:

Products containing CR (manganese dioxide) lithium coin cell batteries may contain perchlorate.

Perchlorate Material — special handling may apply.  
See <http://www.dtsc.ca.gov/hazardouswaste/perchlorate>.



---

## IBM Lotus Software Offer

### **About the offer for purchasers of ThinkPad computers with Windows XP:**

As a qualifying purchaser of a ThinkPad computer with the Windows XP operating system, you are receiving a single, limited license for the Lotus Notes® “standalone” client and a single license for the Lotus® SmartSuite® software. These licenses entitle you to install and use this software on your new ThinkPad computer using one of the following options:

### **About the offer for purchasers of ThinkPad computers with Windows Vista:**

As a qualifying purchaser of a ThinkPad computer with the Windows Vista operating system, you are receiving a single, limited license for the Lotus Notes “standalone” client. This license entitles you to install and use this software on your new ThinkPad computer using one of the following options:

- **Media for this software is not included in this offer. If you do not already have the appropriate Lotus Notes Client or Lotus SmartSuite software media**, you can order a CD and install the software onto your computer. For more information, see “To order a CD” on page 64.
- **If you already have a licensed copy of the software**, you are entitled to make and use one additional copy of the software you have.

**About IBM Lotus Notes:** With your standalone, limited use Notes client, you can integrate your most valuable messaging, collaborative and personal information management (PIM) resources — like e-mail, calendar, to-do list — allowing you to access them while connected to or disconnected from your network. The standalone license does not include the right to access any IBM® Lotus Domino® servers; however this standalone license may be upgraded to a full Notes license at a reduced price. For more information visit <http://www.lotus.com/notes>.

**About IBM Lotus SmartSuite:** Lotus SmartSuite contains powerful applications with timesaving features that give you a head start on your work and guide you through individual tasks.

- Lotus Word Pro® – Word Processor
- Lotus 1-2-3® – Spreadsheet
- Lotus Freelance Graphics® – Presentation Graphics
- Lotus Approach® – Database
- Lotus Organizer® – Time, Contact, and Information Manager
- Lotus FastSite® – Web Publisher
- Lotus SmartCenter – Internet Information Manager

**Customer Support:** For support information and phone numbers to help with initial installation of software, visit <http://www.lenovo.com/think/support>. To purchase technical support beyond this initial installation support, visit <http://www.lotus.com/passport>.

**International Program License Agreement:** The software licensed to you under this offer does not include software upgrades or technical support, and is subject to the terms and conditions of the IBM International Program License Agreement (IPLA) that accompanies the software. Your use of the Lotus SmartSuite and Lotus Notes programs described in this offer constitutes acceptance of the terms of this Offer and the IPLA. For further information regarding the IBM IPLA, visit <http://www.ibm.com/software/sla/slabd.nsf>. These programs are not for resale.

**Proof of Entitlement:** The proof of purchase for your qualifying ThinkPad computer, as well as this Offer document, should be retained as your proof of entitlement.

### **Purchasing Upgrades, Additional Licenses and Technical Support**

Software upgrades and technical support are available for a fee through IBM's Passport Advantage® Program. For information about purchasing additional licenses for Notes, SmartSuite, or other Lotus products, visit <http://www.ibm.com> or <http://www.lotus.com/passport>.

### **To order a CD:**

**Important:** Pursuant to this Offer, you may order one CD media per license. You will need to provide the 7 digit serial number of the new ThinkPad computer that you purchased. The CD is provided at no charge; however, applicable shipping, duties and taxes may be imposed by local jurisdictions. Please allow 10 to 20 business days from receipt of your request for delivery.

#### **-In U. S. Or Canada:**

Call 800-690-3899

#### **-In Latin American Countries:**

Via the Internet: <http://smartsuite.modusmedia.com>

Mail address:

IBM - Lotus Notes and SmartSuite Program

Modus Media International

501 Innovation Avenue

Morrisville, NC, USA 27560

Fax: 919-405-4495

To inquire about an order, contact:

[smartsuite\\_ibm@modusmedia.com](mailto:smartsuite_ibm@modusmedia.com)

#### **-In European Countries:**

Via the Internet: <http://ibm-apel.modus.com/>

Mail address:

Lotus Fulfillment, ModusLink Kft. 1222 Budapest,

Nagytetyenyi ut 112

Hungary

To inquire about an order, contact:

[ibm\\_smartsuite@modusmedia.com](mailto:ibm_smartsuite@modusmedia.com)

**-In Asia Pacific Countries:**

Via the Internet: <http://smartsuite.modusmedia.com>

Mail address:

IBM - Lotus Notes and SmartSuite Program

Modus Media International

eFulfillment Solution Center

750 Chai Chee Road

#03-10/14, Technopark at Chai Chee,

Singapore 469000

Fax: +65 6448 5830

To inquire about an order, contact:

[Smartsuiteapac@modusmedia.com](mailto:Smartsuiteapac@modusmedia.com)

---

## Trademarks

The following terms are trademarks of Lenovo in the United States, other countries, or both:

Lenovo

ThinkPad

PS/2

Rescue and Recovery

ThinkVantage

ThinkPad

TrackPoint

Ultrabay

UltraBase

The following terms are trademarks of International Business Machines Corporation in the United States, other countries, or both:

IBM (used under license)

Lotus

1-2-3

Approach

Domino

Lotus FastSite

Freelance Graphics

Lotus Notes

Notes

Lotus Organizer

SmartSuite

Word Pro

Passport Advantage

Microsoft, Windows and Windows Vista are trademarks of Microsoft Corporation in the United States, other countries, or both.

Other company, product, or service names may be trademarks or service marks of others.

---

# Index

## A

Access Help 1

## B

battery

- problems 23
- replacing 31

Be careful about using your

- computer 3

Be gentle with your computer 4

BIOS Setup Utility 26

## C

carrying the computer 4

cleaning

- computer cover 7
- computer display 8
- keyboard 7
- touch panel 8

computer cover

- cleaning 7

computer display

- cleaning 8

computer screen

- problems 21

configuration setup 26

Customer Replaceable Unit (CRU)

- parts list 51

Customer Support Center 11, 39, 41

## D

diagnosing

- hard disk drive 11
- system 12

diagnosing problems 11

drives

- handling 5

## E

error messages 13

errors without messages 18

## F

factory contents

- restoring 29

FCC statement 60

features 55

features and specifications 55

finding information 1

fingerprint reader 55

- care 8
- problems 25

frequently asked questions 10

## H

hard disk drive

- problem 24
- upgrading 33

hardware features 10

hardware specifications 10

help

- Customer Support Center 39
- on the Web 39

help and service 39

hibernation mode

- problems 20

## I

important tips 3

International Warranty Service 41

## K

keyboard

- cleaning 7
- problems 19

## M

memory

- replacing 35

miscellaneous problems 26

## N

notice

- EU environmental 62
- for US users 62

notices 59

## P

password

- problems 19
- setting 5

PC-Doctor for Windows 11

pointing device problems 20

power management

- problems 20

preventing problems 10

problem solving 10

problems

- battery 23

problems (*continued*)

computer screen 21

diagnosing 11

fingerprint reader 25

hard disk drive 24

hibernation mode 20

keyboard 19

password 19

pointing device 20

power management 20

sleep mode 20

startup 25

troubleshooting 13

Productivity Center 1

## R

Read first v

recovering data 30

recovery discs 10

recovery options 29

Regulatory Notice 1

replacing

- battery 31
- memory 35

Rescue and Recovery 29

restoring factory contents 29

## S

Safety and Warranty Guide 1

safety precautions 10

Setup Instructions 1

sleep mode

- problems 20

solving problems 9

specifications 56

startup problem 25

storage media

- handling 5

## T

Tablet Digitizer Pen

- tips 5

tablet mode

- tips 5

taking care of your computer 3

ThinkVantage button 2

tips, important 3

touch panel

- cleaning 8
- tips 5

trademarks 65  
troubleshooting 13

## **U**

upgrading  
  devices 10  
  hard disk drive 33

## **W**

warranty information 11, 47  
Web  
  help 39



Part Number: 42X3499

Printed in China

(1P) P/N: 42X3499

