

IBM® ThinkPad® X Series Setup Guide

Checklist for unpacking

Thank you for purchasing the IBM ThinkPad X Series computer. Match the items on this list with the items in the box. If any item is missing or damaged, please contact your place of purchase.

Computer



Battery pack

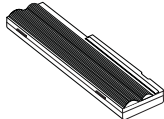

Books

- Service & Troubleshooting Guide
- Setup Guide



AC adapter

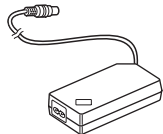

Telephone cable



- Manual Package for Microsoft® Windows



Miscellaneous parts

- TrackPoint® caps

Power cord

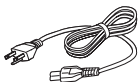



Notes:

1. Some models may contain additional items that are not listed.
2. Your computer features IBM Disk-to-Disk recovery. Everything needed to recover factory-installed files and applications is on your hard disk. Disk-to-disk recovery eliminates the need for a Recovery CD. For more information, see “Recovering preinstalled software” in the Service and Troubleshooting Guide.

Setting up your computer

Connecting to a power source

1. Insert the battery pack into the battery compartment located at the rear of the computer:
 1. Switch the battery lock **1** to the unlocked  position.
 2. Insert the battery pack into the battery compartment. **2**
Note: Depending on the battery option you ordered, your battery may appear different from the figure.
 3. Switch the battery lock **1** to the locked  position.
2. Connect the ac adapter to the computer's power jack (at the rear of the computer) in the order shown.

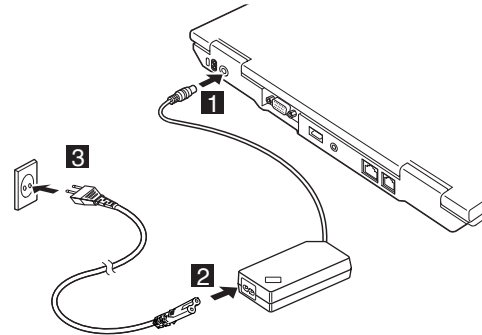
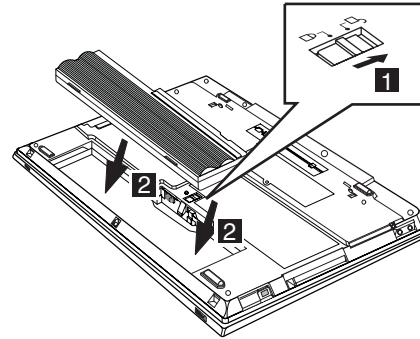

Turning on the system

1. Open the computer display.

Slide the latches **1** and open the display **2**. Then position the display so that it is convenient for viewing.

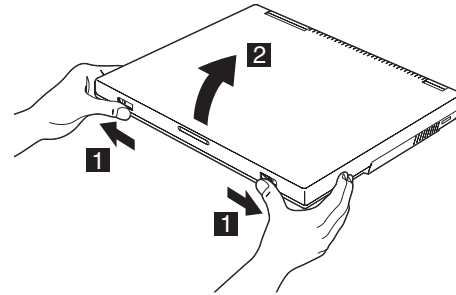

2. Press the power switch.

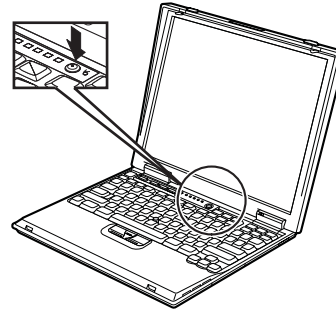

Using the TrackPoint

The TrackPoint® is a unique device for moving the cursor on the screen. You can perform all mouse operations with the TrackPoint. The left and right click buttons function like the left and right click buttons of a mouse.

To move the cursor, use the red-tipped pointer at the center of the keyboard. Press gently with your left or right index finger in the direction you want to move the cursor. To select and drag an object, press and hold one of the click buttons with either thumb as required by your software.

Click means to press the left click button once. **Double-click** means to press the left click button twice within 1 second.

For more information about the TrackPoint, TrackPoint, press the ThinkPad button to open Access ThinkPad, your on-board help system.

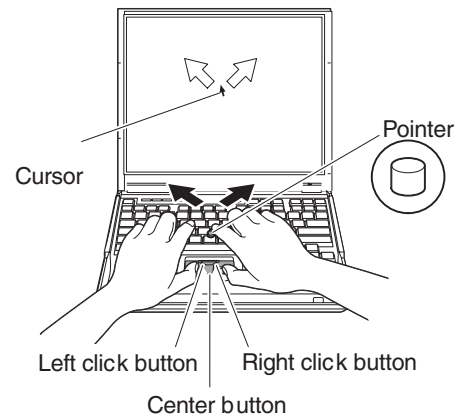

Using the volume control

You can adjust the sound level produced by the built-in speakers by using the following three buttons:

- Volume down



- Volume up:



- Mute:



- If the sound is muted when you turn off the computer, it remains muted when you turn the computer on again.
- To turn on the sound, press the Volume up or Volume down button.

When you press one of these buttons, the volume indicator appears on the screen for a few seconds. For more details on volume control, see the on-board help system, Access ThinkPad.

Setting up Windows

Your computer comes with a Microsoft[®] Windows operating system. After turning on your computer, follow the instructions on the screen to set up the operating system. This procedure takes approximately 10 minutes, and your computer restarts several times.

Finding information with Access ThinkPad

Your computer features the unique ThinkPad Button.

ThinkPad

Whenever you have a question about your computer, or wish to view IBM web sites, simply press the ThinkPad button to open Access ThinkPad.

Access ThinkPad is the comprehensive, on-board help and information center for your computer. It travels with you, eliminating the need to carry reference manuals.

Find information about your ThinkPad computer and its features by using Search function. For direct access to help and support, tips from other mobile users, and information about accessories, software, and upgrades, visit the IBM Web site.

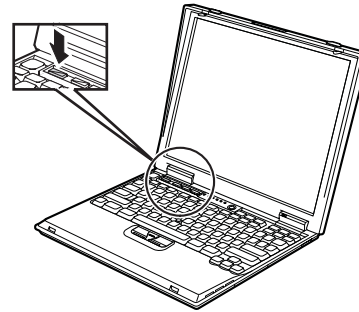

Installing memory

Increasing memory capacity is an effective way to make programs run faster. You can increase the amount of memory in your computer by installing a PC133 dual inline memory module (DIMM), available as an option, in the memory slot on the bottom of the computer. DIMMs with different capacities are available.

Note: Use only a PC133 DIMM in your computer. If you install a DIMM that is not supported by your computer, the computer beeps, and the system does not start. You can purchase the appropriate memory option from your IBM reseller or IBM marketing representative.

Attention: Before you start installing a module, touch a metal table or a grounded metal object. This action reduces any static electricity from your body. The static electricity could damage the DIMM.

To install the DIMM, do the following:

1. Turn off the computer; then disconnect the ac adapter and all cables from the computer.
2. Close the computer display, and turn it over.
3. Remove the battery.
4. Loosen the screw on the memory slot cover; then remove the cover.

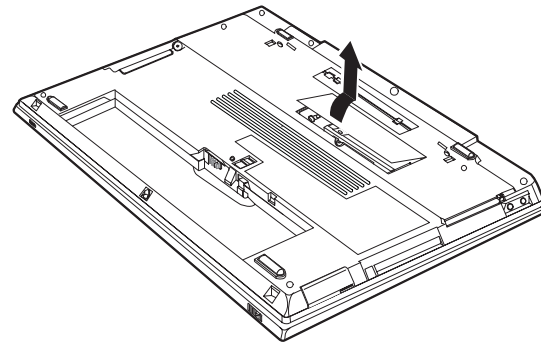

If the DIMM is already in the memory slot, remove it to replace the new one by pressing out on the latches on both edges of the socket at the same time. Be sure to save it for future use.

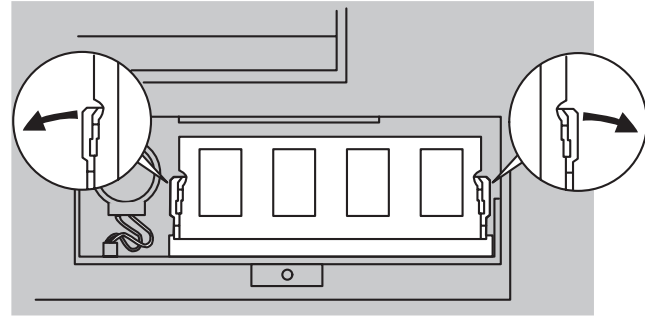

5. Find the notch on the side of the DIMM.

Attention: To avoid damaging the DIMM, do not touch its contact edge.

6. With the notched end of the DIMM toward the right side of the socket, insert the DIMM into the socket at an angle of about 20 degrees **1**; then press it firmly **2**.

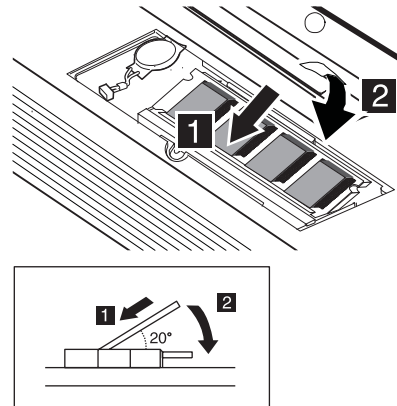

7. Pivot the DIMM until it snaps into place.

Make sure that the card is firmly fixed in the slot and does not move easily.

8. Replace the memory slot cover over the memory slot, aligning the back side of the cover first; then tighten the screw.

Attention: When you have added or upgraded a memory card, do not use your computer until you have closed the cover. Never use the computer with the cover open.

9. Put the battery back in place and turn the computer over again.

To make sure that the DIMM is installed correctly, do as follows:

1. Turn the computer on.
2. While the “Press F1 for IBM BIOS Setup Utility” message is displayed at the lower-left area of the screen, press the F1 key. The IBM BIOS Setup Utility screen appears. The “Installed memory” item shows the total amount of memory installed in your computer. For example, if you install a 64-MB DIMM into a computer whose built-in memory is 64 MB, the quantity shown in “Installed memory” should be 128 MB.

Trademarks

Your Name:

Company Name:

Model Number:

Serial Number:

Company or Reseller Service:

IBM Service Website:

IBM Service Number:

The following terms, in this publication, are trademarks of the IBM Corporation in the United States or other countries or both:

IBM

ThinkPad

TrackPoint

Microsoft and Windows are trademarks of Microsoft Corporation in the United States and/or other countries.

Notes: