

NetVista Thin Client N2200w Windows-Based Terminal

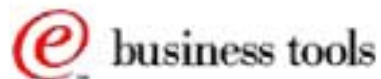

Printing Overview

June 2000



© IBM Corporation

IBM NetVista Thin Clients
Access for today, flexibility for tomorrow



Overview



- **Two possible destinations for a print job:**
 - A remote printer (A printer attached to a print server somewhere in the network)
 - A local printer (A printer which is attached to the WBT)

- **Three possible sources from which the print job might originate:**
 - Applications executed on a Windows server via a Microsoft Remote Desktop Protocol (RDP) session
 - Applications executed on a Windows server via a Citrix ICA session
 - Applications executed locally on the WBT. At this time, the only applications available are emulator applications. For these local applications, we have two possible cases:
 - ▶ Printing from the host application to a system printer or to any printer available from the host where the application is executing
 - ▶ Printing the local presentation space (or a portion of it) to a local (WBT-attached) printer



Notes



OBJECTIVE:

The objective of this presentation is to provide a general overview of the printing facilities available on the N2200w. Because there are many different ways of printing, we break down the topics according to the destination of a print job (remote or local) and according to the origin of the print job (where the application is located). So, we will look at the following cases:

There are two possible destinations for a print job:

- A remote printer, that is a printer attached to a print server somewhere in the network.
- A local printer, that is a printer which is attached to the WBT.

For every case of printing, there are (at the time of this writing) three possible sources from where the print job might originate:

- Applications executed on a Windows server via a Remote Desktop Protocol (RDP) session.
- Applications executed on a Windows server via an ICA session.
- Applications executed locally on the WBT. At this time, the only applications available are emulator applications. For these local applications, we have two possible cases:
 - Printing from the host application to a system printer or to any printer available from the host where the application is executing. This is the business as usual case where the print job is sent to a printer that is either attached to the remote host where the application is executing or to a printer attached to another host but defined in the host where the application is executing. One of these printers could be a WBT-attached printer. In the case of a 3270 application for example, this is the equivalent of printing to a 3287 printer. This is typically called LU1 or LU3 printing, in SNA terminology.
 - Printing the local presentation space (or a portion of it) to a local (WBT-attached) printer. This is typically called a local Print Screen function and consists of copying all, or a portion, of what currently appears on the screen (the presentation space) to a local printer.



Printing to a Remote printer via ICA or RDP

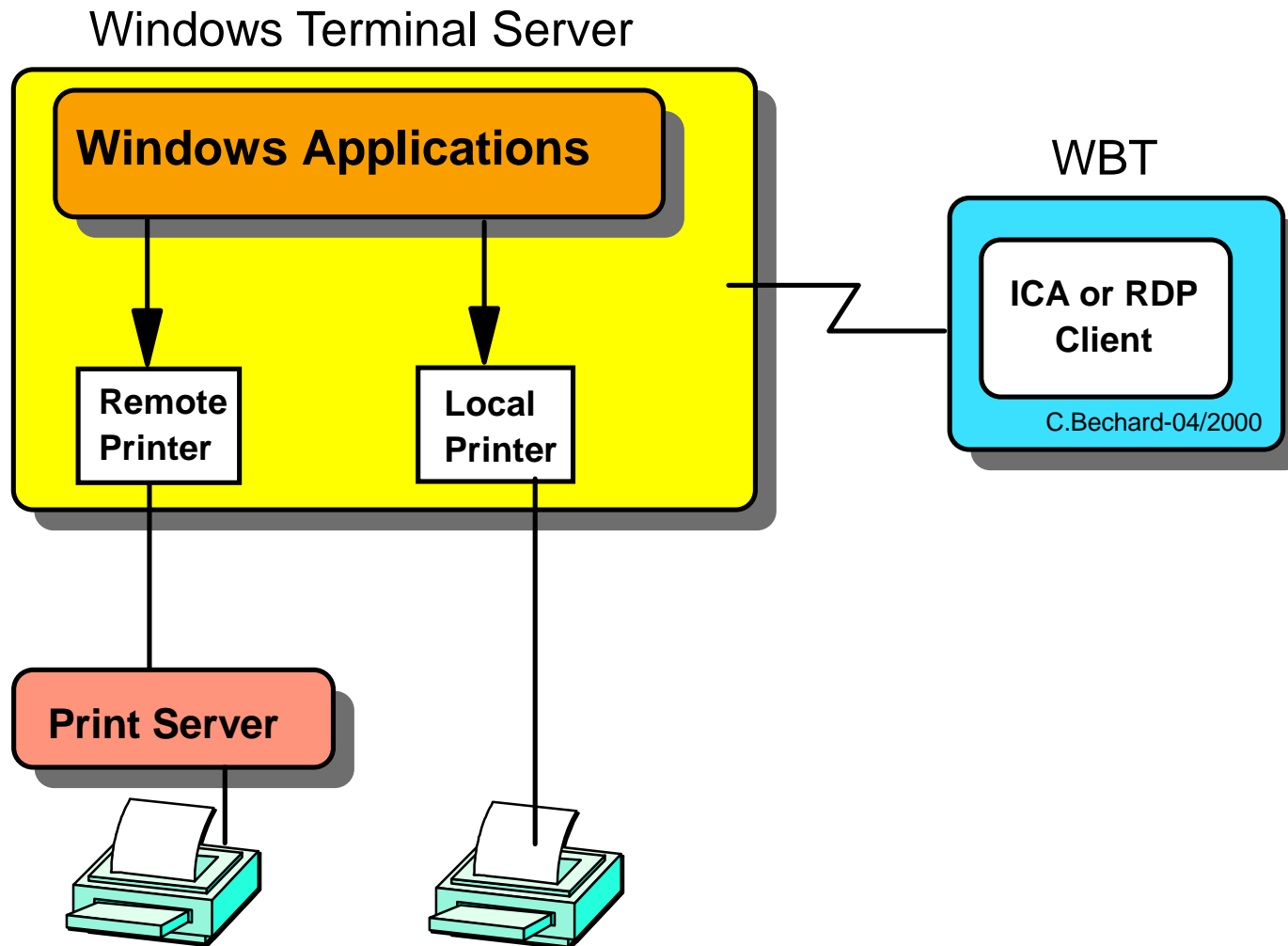



Notes



In the case of applications (a spreadsheet application for example) executed on a Windows server via either an RDP or an ICA session from the WBT, this is really business as usual in the sense that these applications are not different from any other applications executing on a Windows machine and they have access to all the printers that are defined on that server.

These printers can be local to that server, they can be remote shared printers or printers reachable through TCP/IP printing facilities such as LPR/LPD. If the printer can be defined on that Windows server, then it is reachable by the applications.



Printing to a Remote Printer via NetPrint

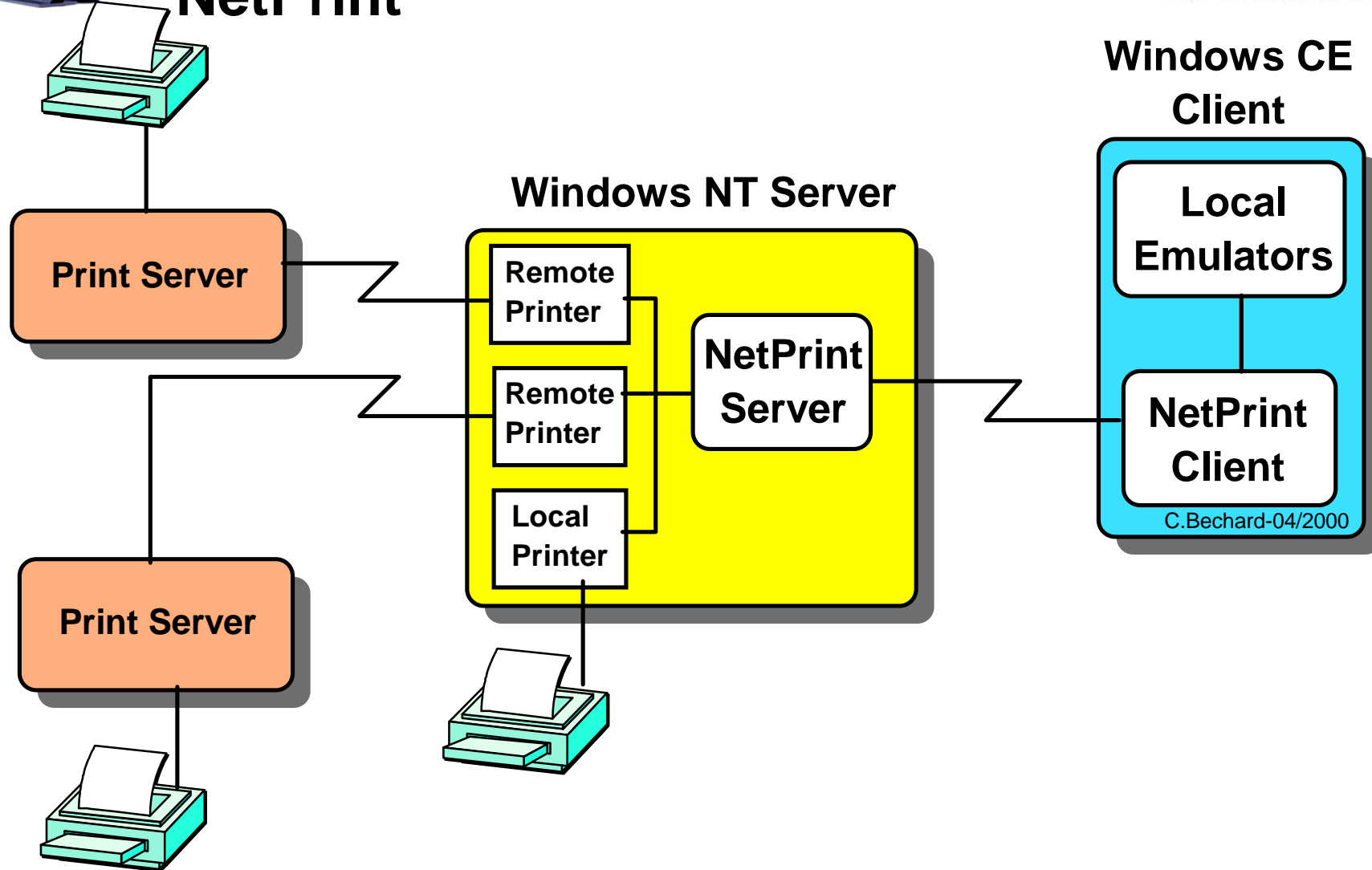

Draft



Notes



Applications that execute locally on the WBT (at the time of this writing, these are emulator applications) can also print to a remote printer by using the facilities provided by a NetPrint server. **Note:** The NetPrint server is a product available separately, from FutureSoft Inc., for a fee. See www.futuresoft.com for details.

Already included in the WBT base operating system (Windows CE) is a NetPrint client module, at no charge, and any application that wishes to print can send their output to the local NetPrint Client. The function of the NetPrint client is to receive the print job from the local application and to route it to a NetPrint server, which in turn hands the print job over to any printer available from that server.

Essentially, the NetPrint client module communicates with the NetPrint server, to get a list of printers that are available (to that client), then the user chooses a printer to which the print job is to be sent. When the application prints, the job is transferred to the NetPrint Server by the NetPrint client, and the NetPrint server spools the job to the appropriate printer.

Any local or remote printer available from the Windows server on which the NetPrint server module is executing is, in theory, available to the WBT. However, the specific printers that are actually made available to the NetPrint client running on a WBT are dependent on the configuration of the NetPrint server that specifies the printers that are to be made available on a client by client basis.



NetPrint Overview



- Provides network printing functionality
- Allows WBT access to network printers
- Print consists of a client and server component
- Supports any Windows NT-compliant printer
- Multiple print servers, multiple printers per server
- Point and click printer selection
- Does not require any Windows CE-based print drivers
- Centralized print administration
- Utilizes small footprint universal print driver
- Server component runs as NT Service



Notes



In summary, these are the main characteristics of the FutureSoft NetPrint Server offering:

- It provides network printing functionality for the WBT allowing local applications to print to any remote printer that is defined on the NetPrint server
- The print subsystem consists of a client, which is free and automatically installed on the WBT, and a server component available for a fee
- Since the server runs on a Windows NT server, it supports any printer which is Windows NT-compliant
- Multiple print servers can be used as well as multiple printers per server
- The selection of a destination printer on the WBT is done via a simple click on a printer selection dropdown list
- The WBT does not require any Windows CE-based print drivers because the print drivers reside on the NetPrint server
- It provides the capability for centralized print administration
- The NetPrint server component runs as an NT Service on the Windows NT server



Print Server Configuration



Print Server Configuration

User Printer View Help

User Name	Default Printer	Printer accepted
administrator	\\NSEDV2R1\IBM Network Printer 17 PCL	No
Anonymous	\\NSEDV2R1\IBM Network Printer 17 PCL	Yes
BabyBlue	\\NSEDV2R1\IBM Network Printer 17 PCL	Yes
IBM	\\NSEDV2R1\IBM Network Printer 17 PostScr...	No

Printer Name	Description
\\NSEDV2R1\IBM Network Printer 17 PCL	\\NSEDV2R1\IBM Network Printer 17 PCL, IBM Network Printer 17 PCL,
\\NSEDV2R1\IBM Network Print	
HP DeskJet 890C Series	
Lexmark Optra PS	
Lexmark Optra R Series	
LPRNP17PCL	
WinCE15231445#IBM Network F	
WinCE15231445#IBM Network F	

For Help, press F1

Printers

User Name: IBM

Available printers:

- HP DeskJet 890C Series
- Lexmark Optra PS
- Lexmark Optra R Series
- LPRNP17PCL
- WinCE15231445#IBM Network Printer 17 PC
- WinCE15231445#IBM Network Printer 17 PS

Assigned printers:

- \\NSEDV2R1\IBM Network Printer 17 PCL
- \\NSEDV2R1\IBM Network Printer 17 PostS

Default printer:
\\NSEDV2R1\IBM Network Printer 17

Buttons: Add ->, <- Remove, OK, Cancel



Notes



How Is the Remote Print Server Configured?

Once the NetPrint server product is installed on a Windows NT server somewhere on the network, and all the printers that we want to make available to the WBT clients are defined on that server, whether they are defined as printers locally attached to the server machine or shared printers on the network, all these printers appear in the NetPrint server configuration window, as illustrated in the next figure.

In this particular example, the top part of the panel lists the different user names and the default printer currently assigned to that user. The Yes or No under the column labeled Printer Accepted indicates whether this particular user has already (some time in the past) connected to this server and selected a printer.

The bottom part of the panel lists all the printers that are currently available to be selected for assignment to a user. In this specific example, the list shows:

- The first two entries are shared printers that are located on a server called NSEDV2R1
- The next three entries are printers defined locally on this server, that is the server where the NetPrint server application is installed
- The LPRNP17PCL is actually an LPR printer port pointing to a printer on a remote LPD server (this could be a full NSM Network Station attached printer for example)
- The last two entries are actually client printers that are WBT-attached (they appear here because the NetPrint server in this example happens to be installed on the MetaFrame server, which is not typical but was done in a test environment with limited machines).

To configure a printer specifically for a user, select a user and double click the entry, which brings up the panel illustrated in the bottom right hand corner, where printers can be added or removed from the list of printer available to that user.



Print Server Settings

NetVista

Printer settings [OK] [X]

Print Server | Printers

Server address

IP Address 90 . 67 . 239 . 50

Host Name

Port Number 2457

Device ID IBM

Printer settings [OK] [X]

Print Server | Printers

Print service address

Host Address: 9.67.239.50

User Name: IBM

Printers

\\\\NSEDV2R1\\IBM Network Printer 17 PCL

[Refresh] [Set as default]

Connect | Edit | Sessi

Close

Print Setup...

Print

About...



Notes



How Is Remote Printing Configured on the WBT?

On the WBT, there are two steps required to select a remote printer.

- Select a NetPrint server.
 - Because there might be more than one NetPrint Server available on the network, a specific NetPrint Server must first be identified.
 - This is done by using Connect on the emulator menu and then Print Setup..., which brings up the panel illustrated in the top left hand corner.
 - A specific NetPrint server is selected by entering either its IP address or its host name.
 - Notice the Device ID field! The name appearing in this field (in this example, the name is hp but in the case of an IBM WBT, the default name is IBM) is what the NetPrint server calls the user name, as was described above when discussing the NetPrint server configuration.
 - In other words, when this WBT NetPrint client contacts the NetPrint server, it identifies itself as user IBM (in this example).
- Select a specific printer on the NetPrint Server, if more than one are available.
 - A click on the Printers tab causes the NetPrint client on the WBT to contact the NetPrint server and to request a list of the printers available to the user called IBM (or whatever is the entry in the Device ID field). This brings up the a panel similar to the one illustrated in the bottom right hand corner.
 - Notice that the selected NetPrint server and the user name appear in the top portion of the panel. The entry appearing in the Printers dropdown list is normally the default printer assigned to that user.
 - A click on the dropdown list displays the other printers that are configured as available to that user.
 - The Refresh button is used to refresh the list if changes have been made on the server since the last time the list was accessed.
 - The Set as default button is used to change the default printer assigned. This actually causes the default printer configuration on the server to be changed.



Print Screen

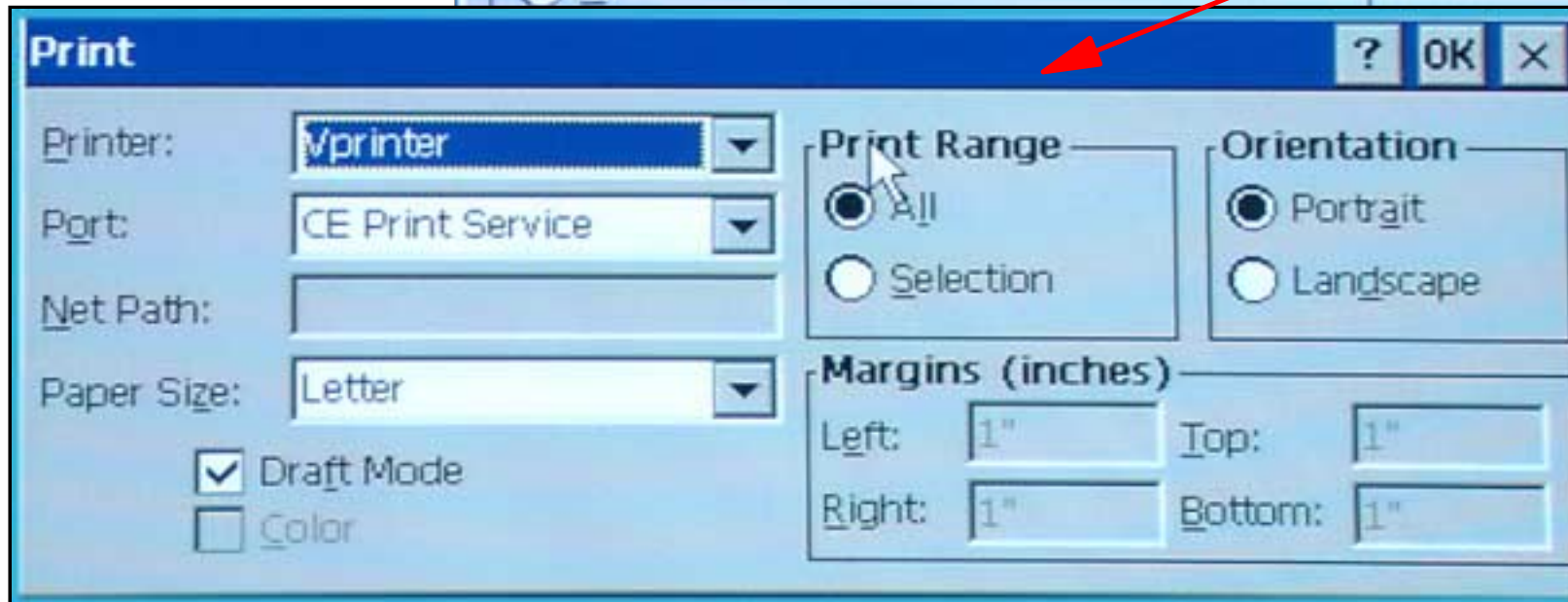
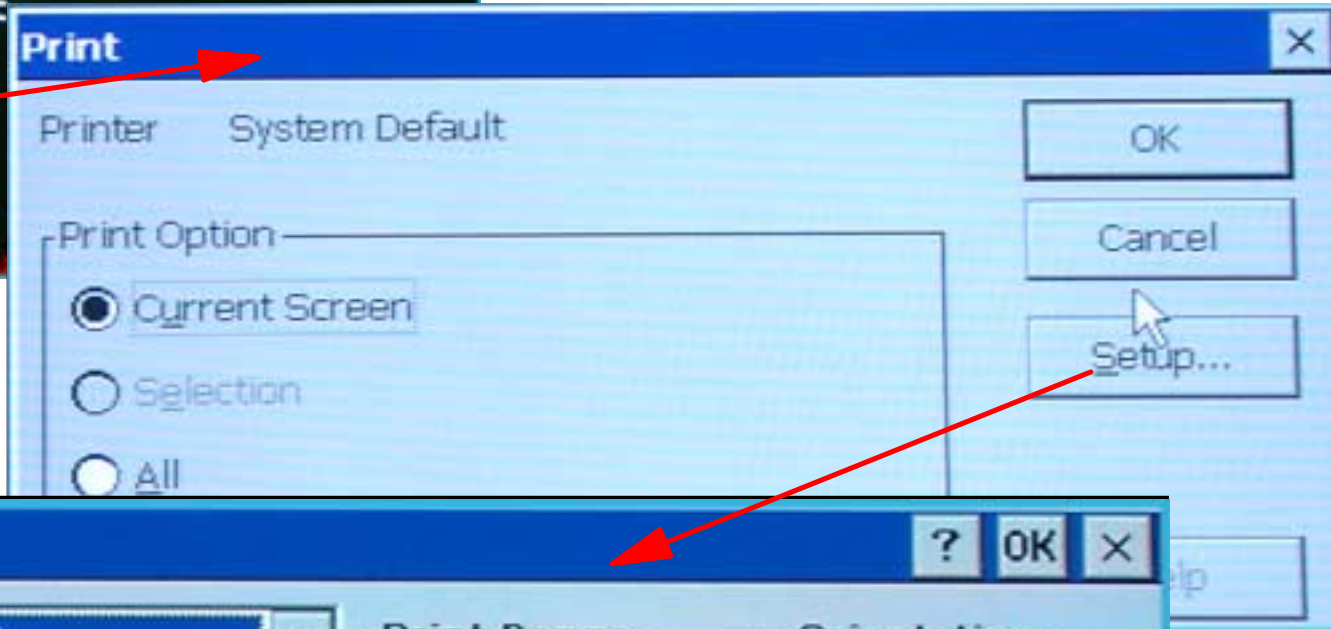
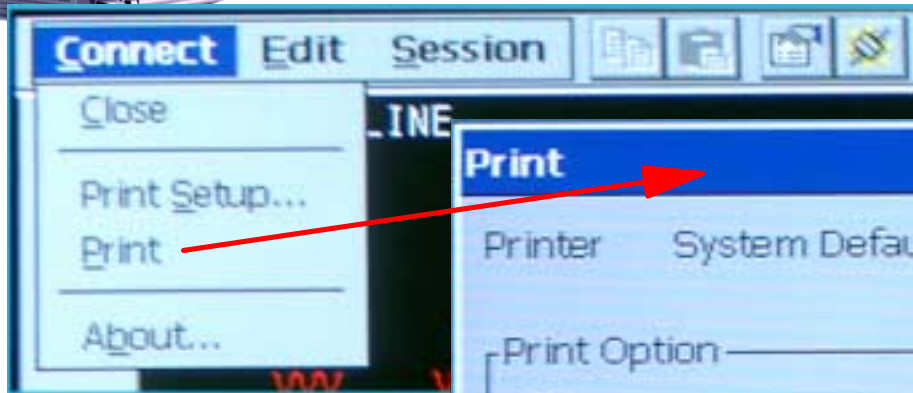



Notes



Printing the Presentation Space (Print Screen)

The whole presentation space (what appears on the screen), or a portion of it, can be selected and printed to a remote printer. To do so, use Connect pulldown on the emulator and select Print.

If a portion of the presentation space is selected prior to entering the Print dialog, only the selected portion is sent to the printer.

By default, the Print Setup identifies the printer as Vprinter and the port as CE Print Service which causes the output to be sent to the local NetPrint Client, and to the printer that has been configured in the Connect => Print Setup.

Printing from a Host Application

Similar to an RDP or ICA session, the host application can print to any printer defined on the host where the application resides.

In the case of a 3270 print for example, a 3270 Print session is defined as a local emulator session and an LU name is specified representing the LU on the host to which a print datastream is sent by the host application through this session.

The output is sent to the printer that has been configured in the Connect => Print Setup on this session.



Printing via RDP or ICA Session

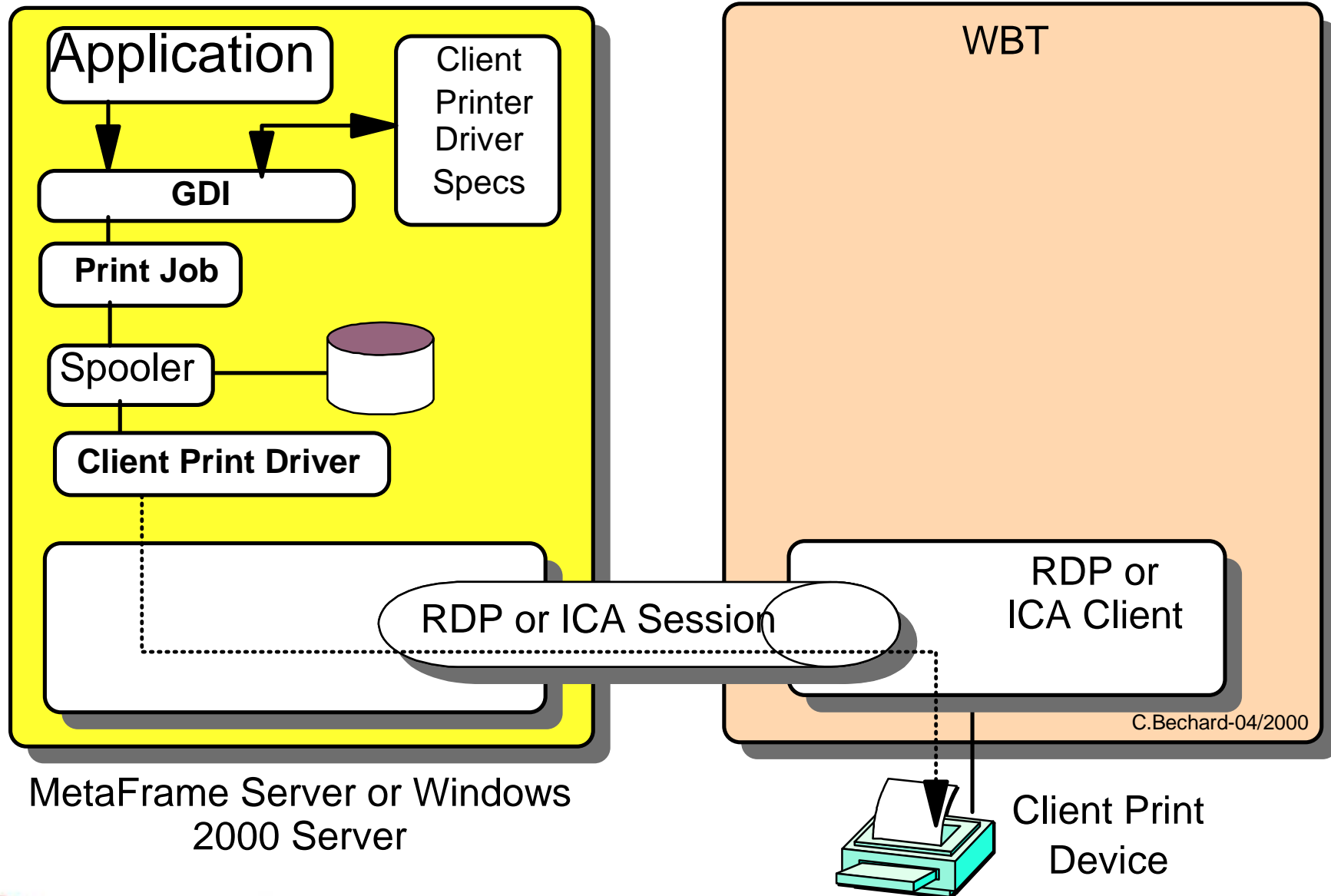



Notes



USB Attached Printer

Printing to a local printer is done through one of the two USB ports available on the N2200w because the N2200w does not have a parallel port, or a serial port. A printer can be attached either directly to the USB port if that printer is a USB printer or it can be attached via a USB to parallel converter adapter if the printer only supports a parallel adapter.

Applications Executed via an RDP Session. For applications executed on a Windows server via an RDP session from the WBT, there are two cases:

- Windows NT 4.0 Terminal Server Edition
 - If the RDP session connects to a Windows NT 4.0 Terminal Server Edition machine, printing to a WBT-attached printer (which is called the client printer) is not supported.
- Windows 2000 Server
 - If the RDP session connects to a Windows 2000 server, the WBT-attached printer can be defined as a client printer and applications executed on the server can sent output to the WBT-attached printer.

How does it work?

In a simplified fashion, the printer attached to the WBT is defined as if it was attached to the server where the RDP session originates, and therefore the appropriate printer device driver can be selected and associated with the printer device.

When the application generates the print datastream, it behaves as if the printer device was local and generates the appropriate datastream. The datastream is then passed-through to the device inside the RDP session and handed over to the client printer device without any modifications, as illustrated in the following figure.



TSE - Adding a Client Printer



Printers

File Edit View Favorites Tools Help

Back Forward Stop Search Folders History

Address Printers

Printers

Add Printer

Local WBT Printer/IBMWB T/Session 2

Local WBT Printer/IBMWB/Session 2

Documents: 0

Status: **Ready**

Model: HP DeskJet 895Cse

Waiting Time: 0

Local WBT Printer/IBMWB/Session 1 Properties

Color Management Security Device Settings Services

General Sharing Ports Advanced

Always available

Available from 12:00 AM To 12:00 AM

Priority: 1

Driver: HP DeskJet 895Cse

- HP DeskJet 895Cse
- IBM Network Printer 17 (PCL)
- IBM Network Printer 17 PCL
- IBM Network Printer 17 PS

Spooler

S...

New Driver...



Notes



How Is It Defined on the Windows 2000 Server?

In this environment, when the RDP 5.0 client on the WBT connects to a Windows 2000 server, a client printer is automatically defined (by default) and automatically appears in the Printers folder for that user.

- The name of the printer is in the format “PrinterName/ClientName/Sessionx” where:
 - PrinterName is whatever Printer name was used to define this printer originally (the default driver for that printer is a HP Deskjet 895C printer).
 - ClientName is the name of the client as defined on the WBT. This is the Terminal Name parameter on the Terminal Properties/Network panel on the WBT.
 - Sessionx is automatically generated by the Terminal Server and x is incremented in some fashion, dependent on the number of active sessions.

The panel here illustrates what a Printers folder contains for a user after he logged on using an RDP session. The printer is called Local WBT Printer/IBMWBT/Session2.

If we take a look at the Properties of this printer and use the Advanced tab of the Properties panel (illustrated partially in the next figure), it shows that the printer driver used for that entry is the HP Deskjet 895Cse.



Applications Executed via ICA



Printers			
Name	Documents	Status	Comment
Add Printer			
IBM Network Printer 17 PCL on NSEDV2R1	0		
LPRNP17PCL	0		
WinCE13538264#IBM Network Printer 17 PCL	0		Auto Created Client Printer WinCE13538264

NSEDWTSE - Citrix Server Administration

ons View Options Help

All Listed Servers

- NSEDDOM
 - NSEDW2K
 - NSEDWTSE
 - ICA-netbios (listen...)
 - ICA-tcp (listener...)
 - RDP-tcp (listen...)
 - Console (admini...)
 - ICA-tcp#10 (cla...)

Users Sessions Processes Licenses ICA Browser Information						
Session	User	ID	State	Type	Client Name	
ICA-netbios		2	listen	Citrix ICA 3.0		
ICA-tcp		3	listen	Citrix ICA 3.0		
RDP-tcp		4	listen	Microsoft R...		
Console	administrator	0	active	Console		
ICA-tcp#10	claud	10	active	Citrix ICA 3.0	WinCE13538264	
		11	idle			
		12	idle			





Notes



Applications Executed via ICA

For applications executed on a MetaFrame server via an ICA session from the WBT, (and this is valid for both a MetaFrame server on a Windows NT 4.0 server or Windows 2000 server) the WBT-attached printer can be also be defined (mapped) as a client printer, similar to what we described above for an RDP session to a Windows 2000 server, but with a few differences.

When a WBT initially connects to a MetaFrame server, a client printer is not automatically defined by default (as in an RDP session to a Windows 2000 server) but it must be defined initially by the owner of the ICA session by using the ICA Client Printer Configuration application. Once it has been defined however, the printer is automatically deleted when the ICA session is ended, and automatically recreated (albeit with a different name every time) when the ICA session is reestablished.

In the case of a MetaFrame server, the name of the printer is in the format “ClientName#PrinterName” where:

- ClientName is a name which is dynamically generated by MetaFrame each time that the WBT connects into the server. For example, WinCE089361.
- PrinterName is the name that was used when this printer was originally defined on the server.

For example, the top panel here illustrates the Printers folder after an ICA client has connected into the MetaFrame server.

The client name can also be seen on the MetaFrame Administration panel, using the sessions tab, as illustrated in the bottom figure here.



ICA Client Printer Configuration



WinCE13538264 - ICA Client Printer Configuration			
Printer View Help			
Printer Name	Type	Port	Status
WinCE13538264#IBM Network Printer 17 PCL	IBM Network Printer 17 PCL	LPT1:	Connected

WinCE#IBM Network Printer 17 PCL Properties

General | Ports | Scheduling | Sharing | Security | Device Settings

WinCE#IBM Network Printer 17 PCL

Comment:

Location:

Driver:



Notes



For this printer to appear automatically, the user had to initially use the ICA Client Printer Configuration Application to create the printer once.

This application is initiated by using Start => Programs => MetaFrame Tools => ICA Client Printer Configuration, which brings up the panel illustrated at the top.

Initially, there are no entries in this panel and the user must select Printer => New in order to define the initial printer.

The user selects the appropriate driver printer from a list and the only choice for the port is LPT1. The printer driver for the selected printer must already have been installed by the administrator in order to be available.

Note: On a CDS (Citrix Device Services) server, there isn't an ICA Client Printer Configuration application, so the printer is added using the normal Add Printer Wizard, and adding a Client Printer Port using the same nomenclature for the name of the printer.

Permanent Printer Definition

If having a printer name that is dynamically generated on every connection presents a problem, there is a way to prevent the removal and re-addition of the client printer at every connection by modifying the description of the printer once.

This is done by accessing the Printer Properties with a right click on the printer icon for example, which brings up the panel illustrated in the bottom right hand corner.

In this example, the Comment field normally contains the string Auto Created Client Printer WinCE00159346. We removed the words Auto Created, as indicated in the figure here. The result of this action is that this printer definition remains permanently from this point on and is not removed when the ICA session ends.

This could likely be used so that the printer queue can be put in hold mode for example, and print jobs could be sent to this printer while the client is actually not connected, but spooled out to the client's printer after the session reconnects and the printer resumes printing.



CDS - Add Client Printer



1 My Computer

2 Available ports:

Port	Description	Print
<input checked="" type="checkbox"/> LPT1:	Local Port	Net-
<input type="checkbox"/> LPT2:	Local Port	
<input type="checkbox"/> LPT3:	Local Port	
<input type="checkbox"/> COM1:	Local Port	
<input type="checkbox"/> COM2:	Local Port	
<input type="checkbox"/> COM3:	Local Port	

3 Available Printer Ports:

- Client Printer Port
- Digital Network Port
- Lexmark Network Port
- Local Port

4 Enter a port name:
Client\LPT1:



Notes



If the terminal server is a CDS server instead of a MetaFrame server, there is no ICA Client Printer Configuration application that can be used. Instead, a client printer is defined using the Add Printer wizard, select My Computer, then Add Port, select the Client Printer Port and enter Client\LPT1 as the port name.

Note that you enter the string "Client\LPT1" as is, and do not replace Client with the client name.



CDS - Add Client Printer

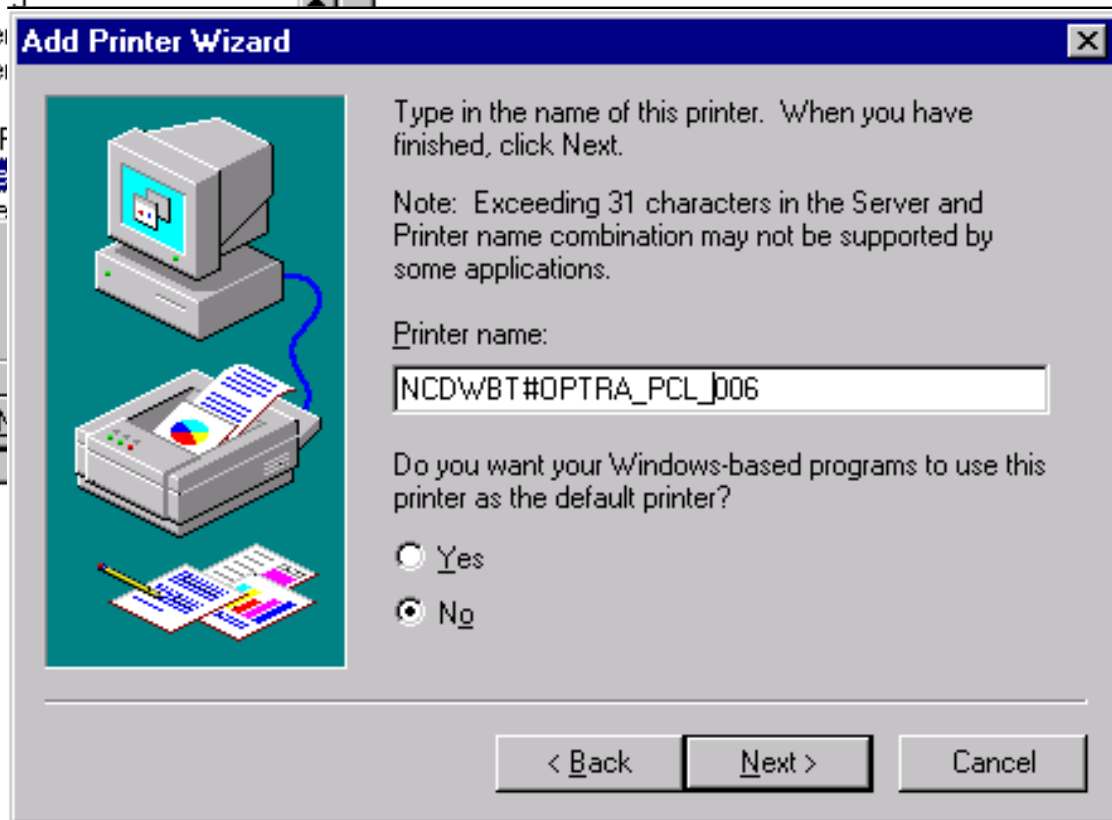
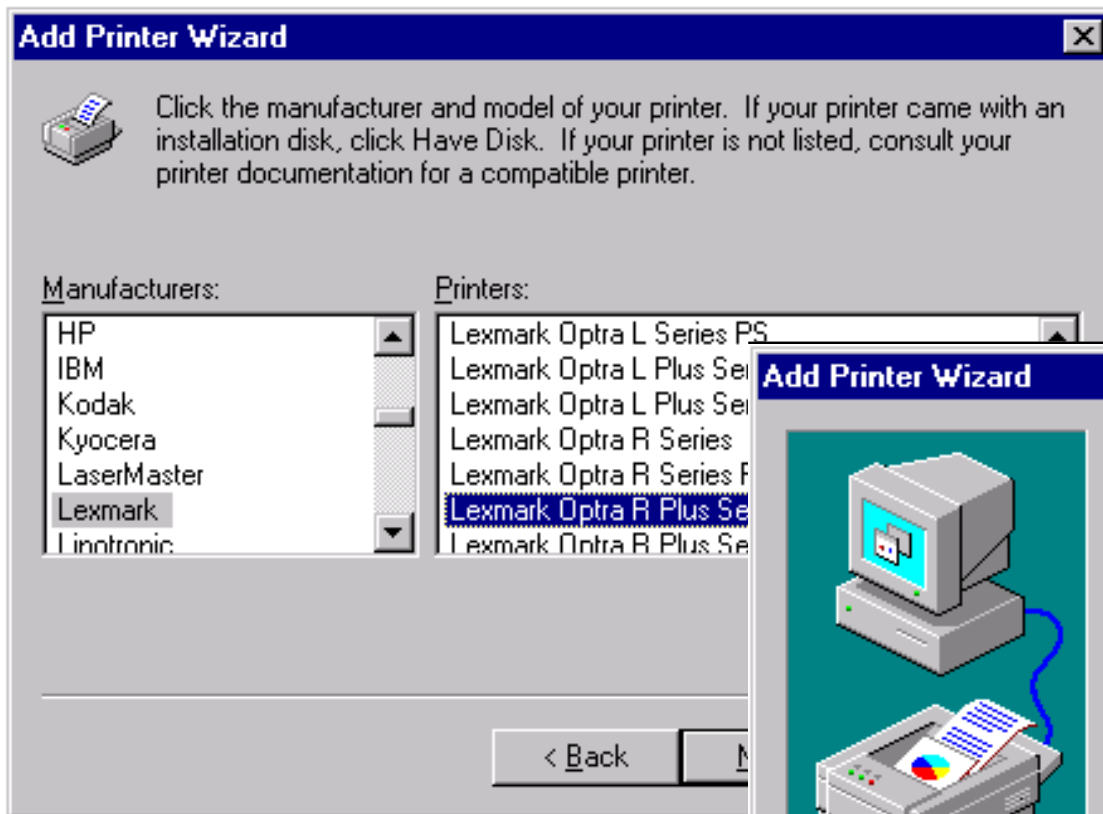



Notes



Then select the printer, and enter the printer name as Client Name#Printer Name, where client name is the name of the client as it appears in the Terminal Server Administration panel, and printer name is whatever name you want to use.



Print Setup - Local Printing

NetVista

The image shows a sequence of three screenshots illustrating the steps to set up local printing in NetVista:

- Top Screenshot:** A terminal window with a menu open. The 'Print' option is selected, and a red arrow points to the 'Print' dialog box.
- Middle Screenshot:** The 'Print' dialog box is shown. The printer is set to 'System Default'. The 'Print Option' section has 'Current Screen' selected. A red arrow points to the 'Setup...' button.
- Bottom Screenshot:** The 'Print' dialog box is shown in more detail. The 'Printer' dropdown is set to 'vprinter'. The 'Port' dropdown is set to 'CE Print Service'. The 'Print Range' section has 'All' selected. The 'Orientation' section has 'Portrait' selected. The 'Margins (inches)' section shows 'Left: 1"'. Two red arrows point to the 'Printer' and 'Port' dropdowns. Below the main dialog, two inset windows show the contents of these dropdowns: the 'Port' dropdown lists 'CE Print Service', 'COM1: 57600', 'IRDA', and 'LPT1:' (circled in red); the 'Printer' dropdown lists 'vprinter', 'PCL Inkjet', and 'PCL Laser' (circled in red).



Notes



Applications Executed locally on the WBT: For application executing locally on the WBT there are two cases:

- Printing the presentation space locally (local Print Screen)
 - In this case, instead of using the Connect => Print Setup function on the Emulator Menu bar to connect to a NetPrint server and to select a remote printer, the user goes to Connect => Print.
 - On the Print panel, the user selects the entire screen or, if a selection was made prior to entering this function, the selection button is already preselected, indicating that the user only wants to print the selected portion of the presentation space.
 - The user then uses the Setup... button, which brings up the standard Windows CE 2.1 Common Dialog for Printing. This panel contains an entry called Printer where the preselected entry is Vprinter and the Port entry contains the value CE Print Service, which are the normal settings for printing to a remote printer through the NetPrint server. The printer entry can be changed by selecting either InkJet printer or Laser printer in the printer selection drop down and the port entry can be changed to LPT1.
 - A click on OK and then OK again on the main Print panel causes the content of the screen to be sent to the local LPT1 port.
- Printing from a host application to the local printer
 - When executing a host application through an emulator, the host application can print to any printer that is defined on that host.
 - In the case of a 3270 application for example, the printer would often be a 3287 printer which is attached to the same control unit as the display used for the 3270 emulator session.
 - A similar capability is provided by creating on the WBT a 3270 Print session. This is done in the same way as creating a normal 3270 display session but the user chooses the entry 3270 Print (instead of IBM3270) on the Emulations Tab of the Session Properties panel. This creates the equivalent of a 3287 printer which corresponds to the LU defined on the host for a 3287 printer.



Local Printing

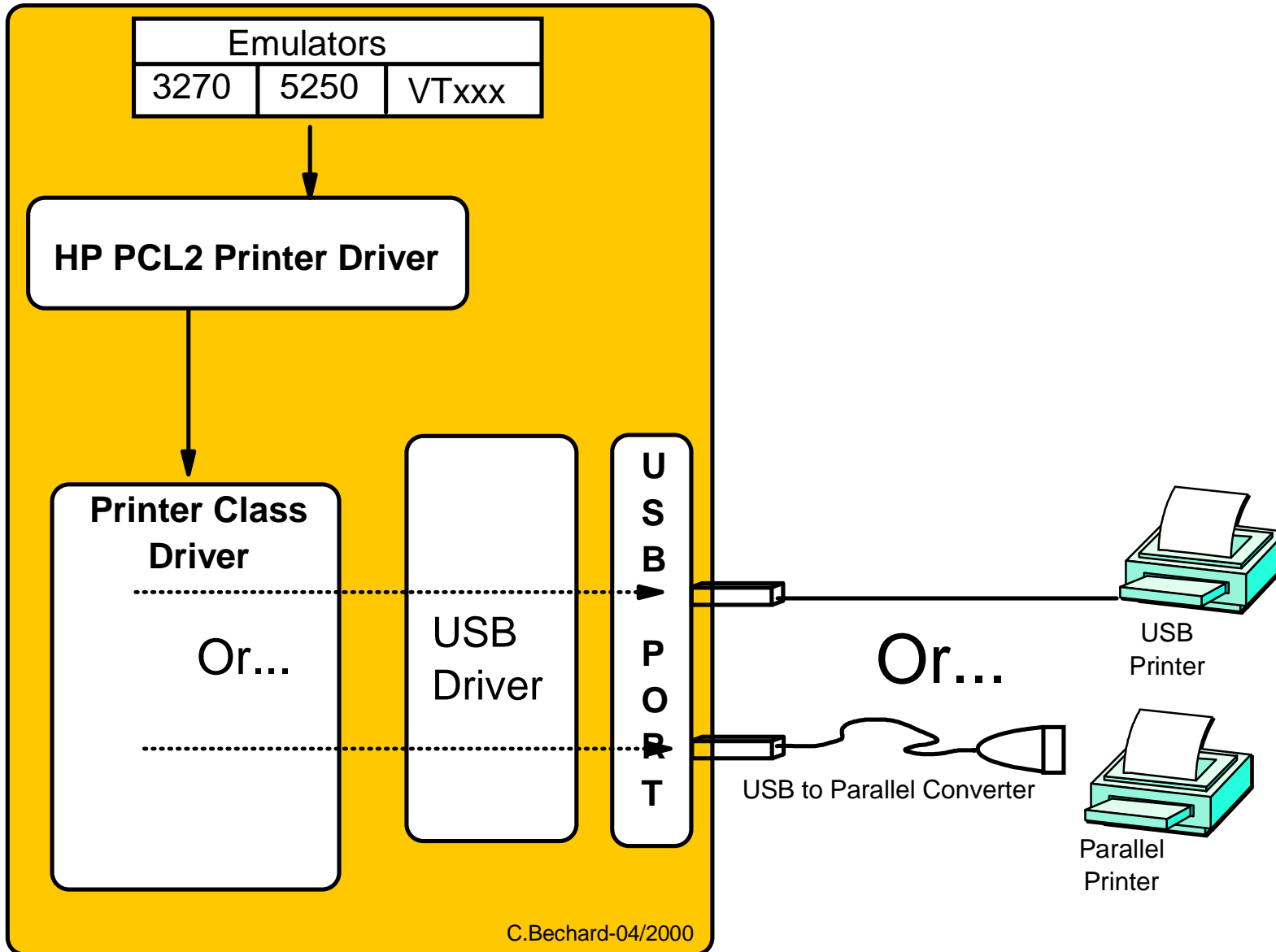



Notes



How does local printing work?

At the moment, when the user selects to print locally on a WBT-attached printer, the local application (in this case, the emulators) starts by presenting the Print Dialog on which the user can choose the following:

- Printer: Vprinter (default), PCL Inkjet, PCL Laser
- Port: CE Print Service (default), LPT1, COM1:57600, IRDA and Network
- Paper Size: Letter (default), Legal, A4 B5
- Network Path:
- Print Range: Choices are All (Default) or Selection
- Orientation: Choices are Portrait (Default) or Landscape
- Margins: Left, Right, Top and Bottom

Once the a selection has been made on this panel, for example PCL Inkjet on LPT1, the application uses a generic HP PCL2 Printer driver to generate a PCL2 datastream (this is the only available choice at this time).

This datastream is then handed over to a Printer Class Driver, whose role it is to determine whether the attached printer is a printer connected directly to a USB port or whether it is a parallel printer attached via a USB to parallel converter, as illustrated in the figure below.



Emulator Print Session

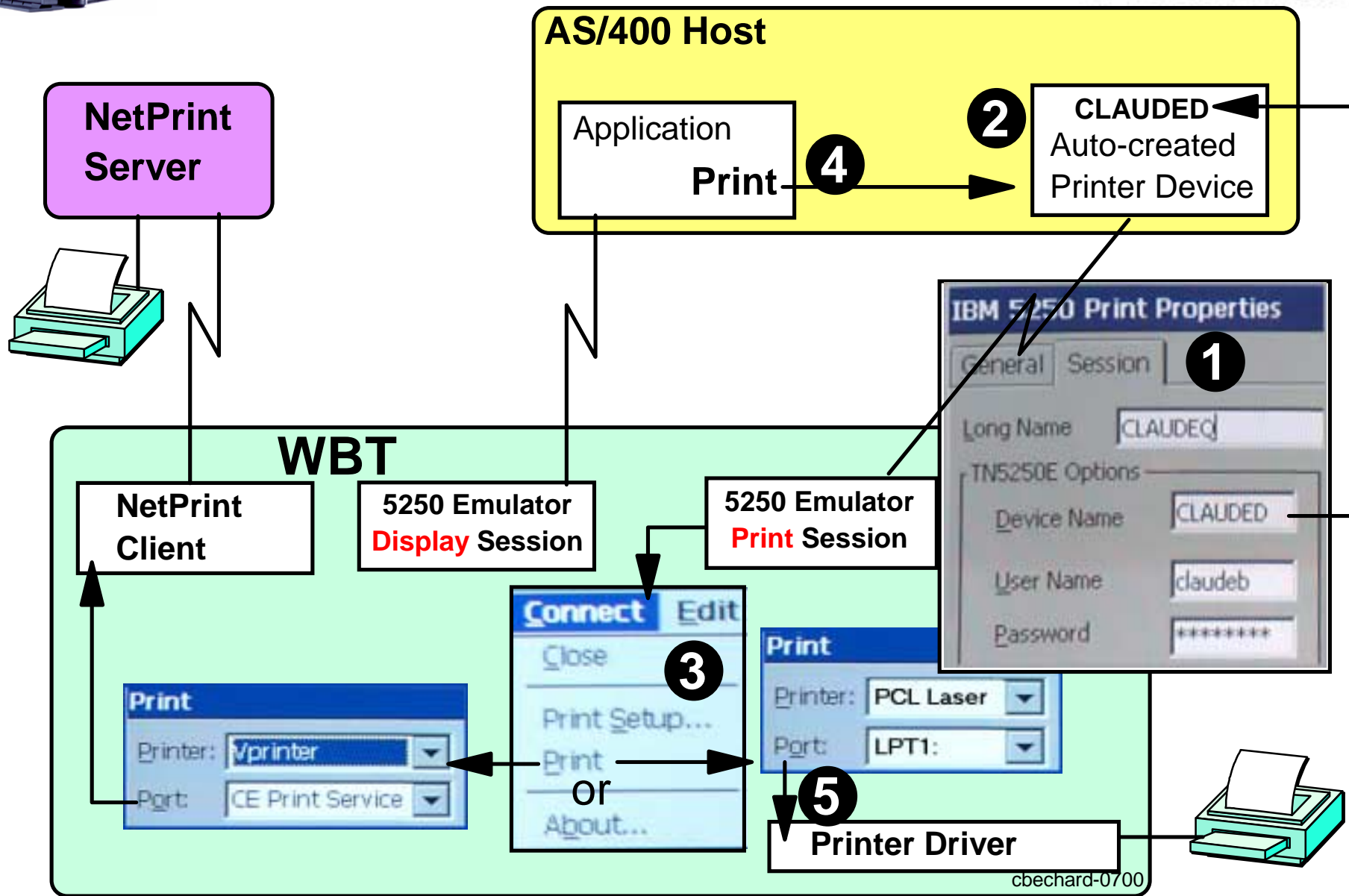



Notes



This chart might appear complicated at first, but it is mainly because it illustrates the main steps, in time, to use an emulator print session. The overall objective is to use a 5250 emulator display session and a 5250 emulator print session, and to print from the AS/400 using the print session. We have the following components:

- On the WBT, we define a normal 5250 emulator display session and get that connected to an AS/400
- On the WBT, we also define a 5250 Emulator Print Session. As indicated by the number 1, notice that we indicate the device name as CLAUDED. When we start this session and it connects to the AS/400, it causes the auto-creation of a print device called CLAUDED, as indicated in number 2.
- Next, on the 5250 Print Emulator session on the WBT, we configure where we want the printed output to go. That is, the print datastream will be sent from the host using the print session, but we have a choice of sending the output to a remote printer or to a local WBT-attached printer.
- As indicated in number 3, the print destination is configured by selecting Print on the Connect pulldown in the emulator session, then Setup on the next panel, which brings us the choice indicated here. If we select CE Print Service as the port, the output is sent to the NetPrint Client which then sends it to the NetPrint server. This further configuration of which printer to select on the NetPrint server is done using the Print Setup entry on the Connect pulldown. If we select LPT1 as the port, the output is routed to the local Print driver handling the printer locally attached via the USB port on the WBT.
- In number 4, the user starts an application on the AS/400 via his emulator display session and requests the output to be routed to the CLAUDED printer device, which sends it along to the 5250 Print session.
- Assuming we had chosen LPT1 as the destination port, the output is then sent to the local printer, as indicated in number 5.

There are other considerations in terms of how the printer is defined on the AS/400, and how the queues are managed, as well as the drivers used to print, which are outside the scope of this discussion at this time.



Defining a Local ICA Client Printer as a Remote Printer in NetPrint



Windows Terminal Server Edition with MetaFrame

WBT

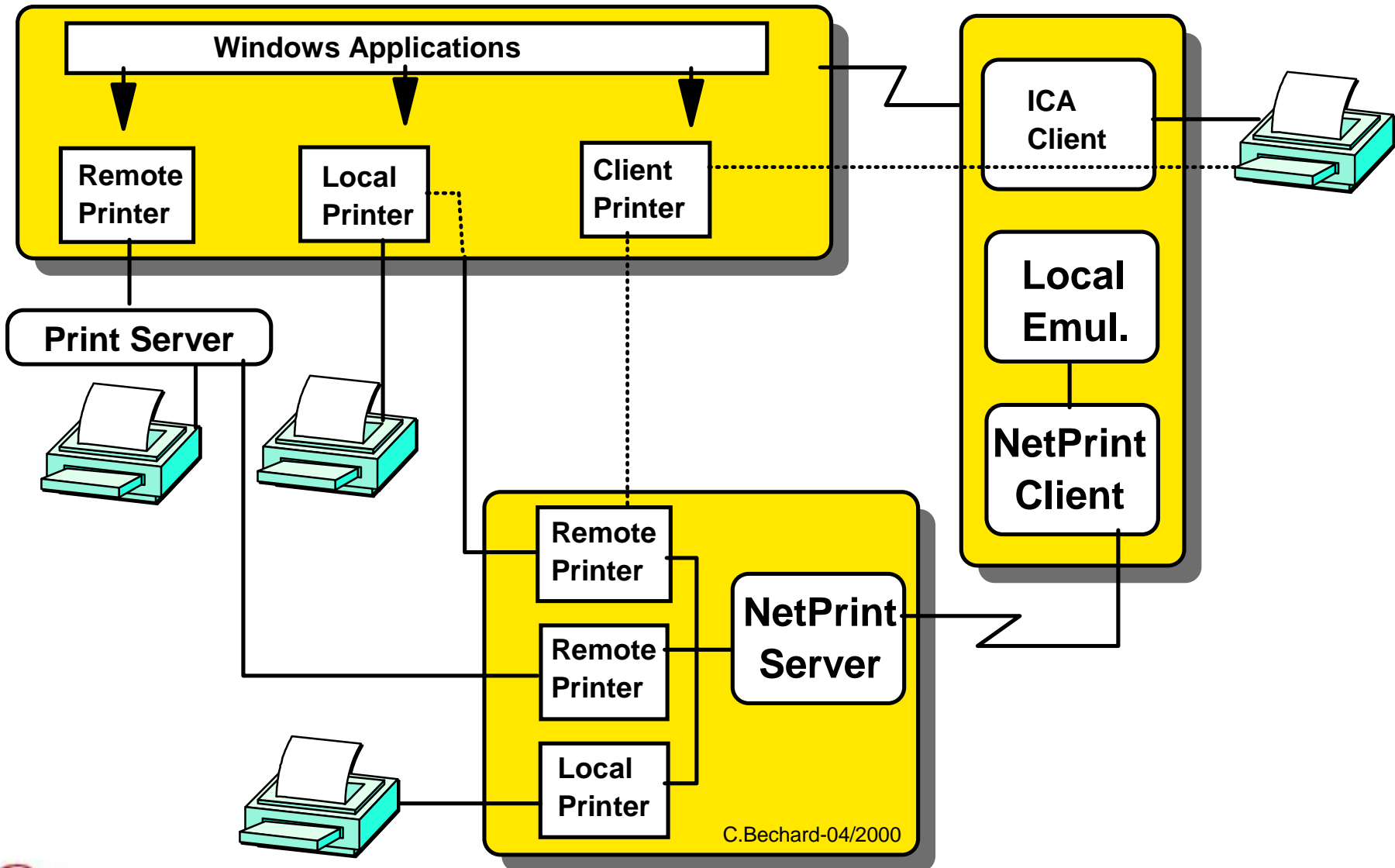



Notes



Since the WBT-attached printer can be defined as a client printer in an ICA session, this printer appears on the MetaFrame server as an available printer and can therefore be selected by local applications (from other users connected via an ICA session for example) as the print destination.

This printer can also be shared on the network and therefore be selected by remote users on the network, allowing them to send print output to the WBT-attached printer. Since a shared printer is available to the NetPrint server, we have also been able to assign the WBT-attached printer as any other remote printer and to specify it as the destination printer in an emulator session, effectively configuring the local WBT-attached printer as if it was a remote printer. Indeed, we have been able to make this work somewhat, but with some problems related to the speed of the output, the cause of which we are still trying to identify.

In a situation where there are many WBTs, one of which with an attached printer, this method would allow the other WBT's to direct their printing to a peer WBT, as long as this peer WBT has an active ICA session.



Same Physical Client - Multiple Servers



Windows Terminal Server Edition with MetaFrame

WBT

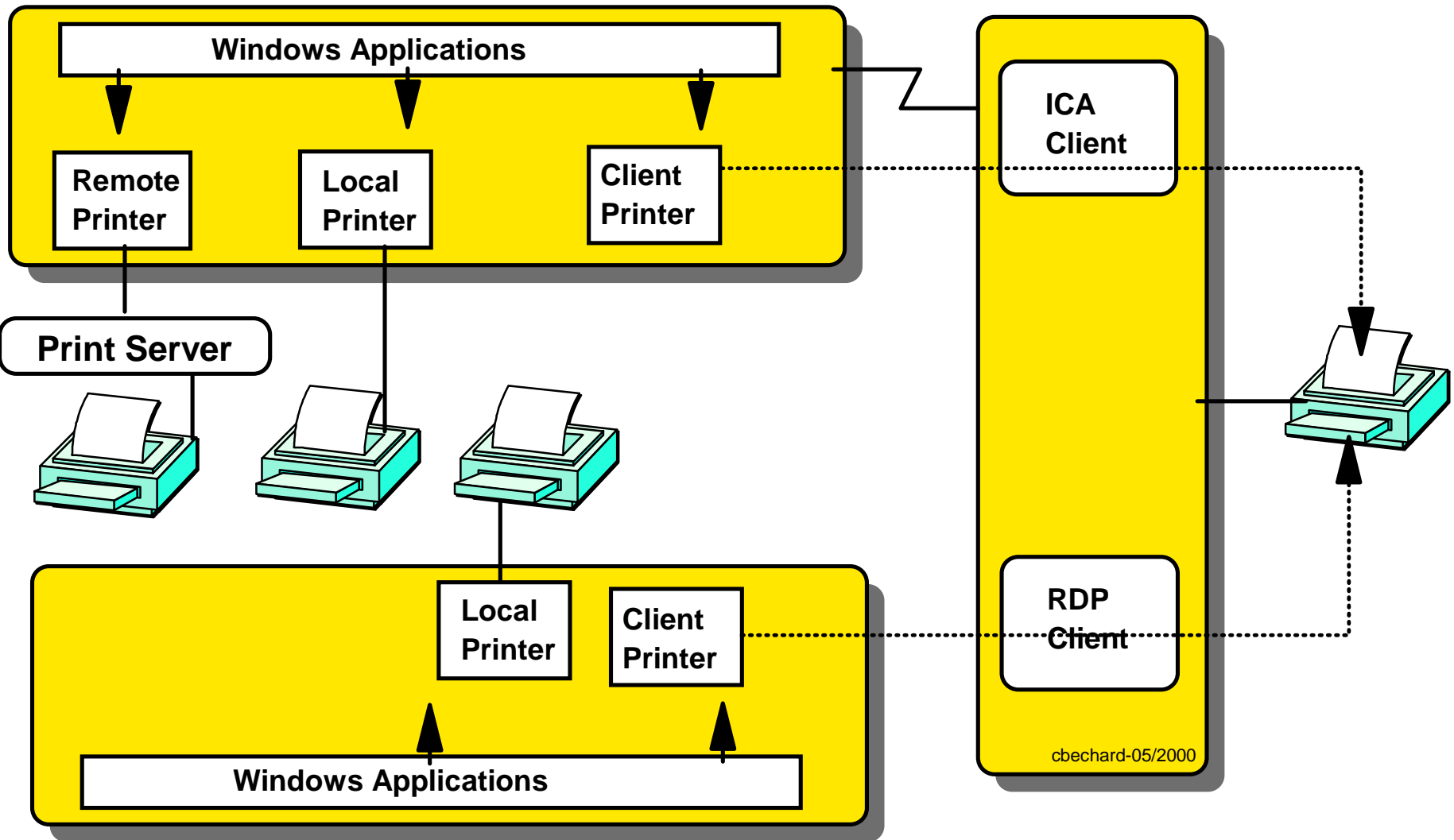

Windows 2000 Server



Notes



As illustrated in this chart, it is possible to have multiple ICA and RDP sessions to multiple MetaFrame and Windows 2000 servers.

In that case, each client can have the local WBT-attached printer defined as a client printer in more than one server.

This is possible to do, and to define, without entering into any conflicts, as long as two sessions do not try to print at the same time.

If the user prints from the ICA session, and then, when printing is completed, prints from the RDP session for example, both printouts should print correctly.

If one session tries to print while another is still spooling data to the printer, the user gets an error message indicating that the device is busy, and is given the option to retry or cancel. If the user waits until the first server has finished spooling out, and then clicks on Retry, the job prints correctly.

In effect, this is sort of a manual setup where the user is acting as the scheduler and must wait for one job to end before sending the other.



Same Physical Client - Multiple Servers



Windows Terminal Server Edition with MetaFrame

WBT

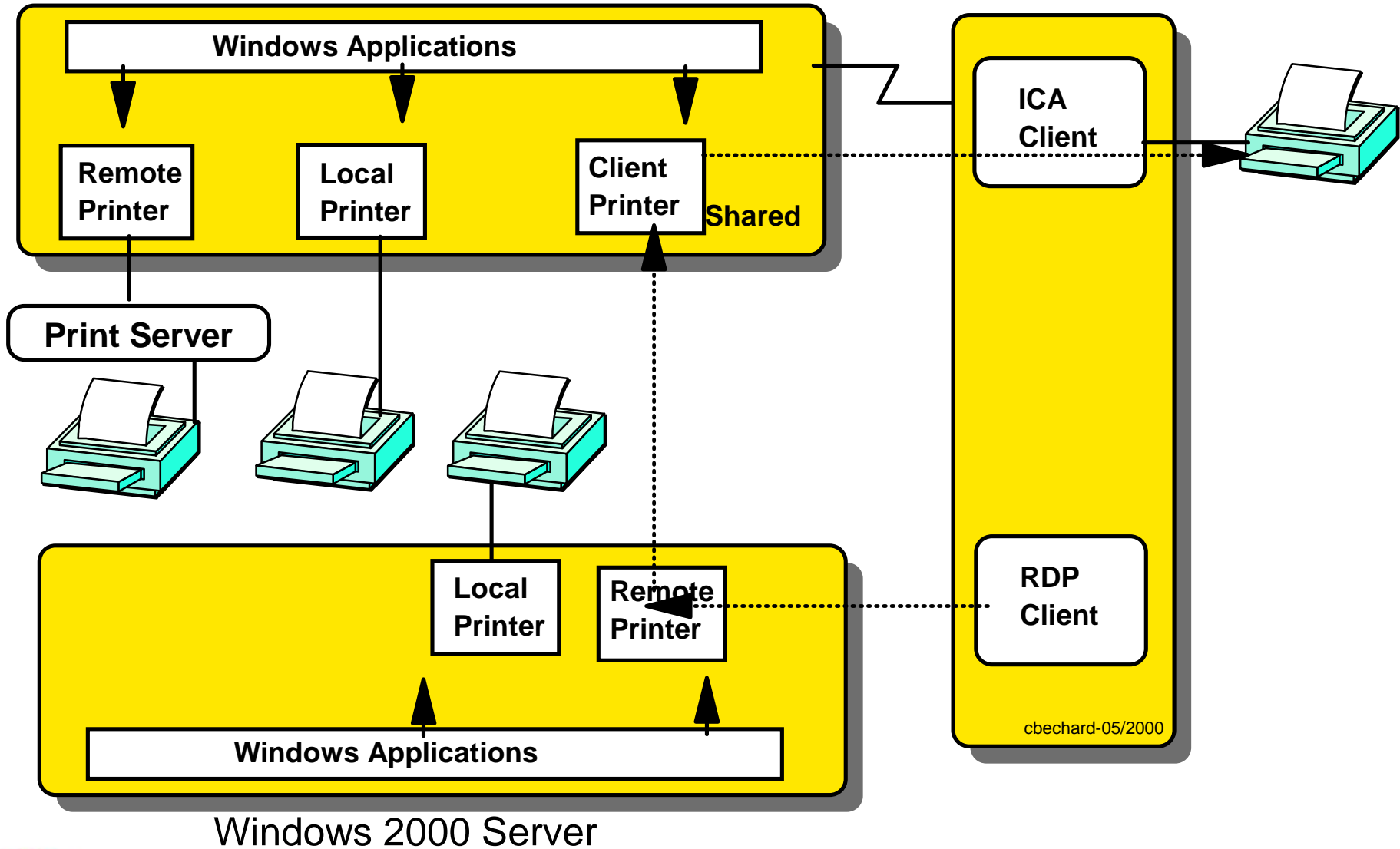



Notes



A better way to set this up so that the system manages the print queue automatically is to define a client printer in one MetaFrame system, and then define it also as a shared resource that can be selected on other servers as a remote printers.

This way, all output goes to the same queue and is managed automatically by the system, as illustrated in this chart.

In this case however, it is probably preferable to define the client printer as a permanent definition (as opposed to auto-created and auto-removed) so that it can be shared on the network and made available to other servers.