



# 40/80 GB DLT Internal Tape Drive

---

*User's Guide*

Be sure to read the important  
maintenance information on page 2-1.

OPTIONS  
*by IBM*

**Note:** Before using this information and the product it supports, be sure to read the information under Appendix F, “Product warranty and notices” on page 2-8.

## **Second Edition (April 2000)**

**The following paragraph does not apply to the United Kingdom or any country where such provisions are inconsistent with local law:** INTERNATIONAL BUSINESS MACHINES CORPORATION PROVIDES THIS PUBLICATION “AS IS” WITHOUT WARRANTY OF ANY KIND, EITHER EXPRESS OR IMPLIED, INCLUDING, BUT NOT LIMITED TO, THE IMPLIED WARRANTIES OF MERCHANTABILITY OR FITNESS FOR A PARTICULAR PURPOSE. Some states do not allow disclaimer of express or implied warranties in certain transactions, therefore, this statement may not apply to you.

This publication could include technical inaccuracies or typographical errors. Changes are periodically made to the information herein; these changes will be incorporated in new editions of the publication. IBM may make improvements and/or changes in the product(s) and/or the program(s) described in this publication at any time.

This publication was developed for products and services offered in the United States of America. IBM may not offer the products, services, or features discussed in this document in other countries, and the information is subject to change without notice. Consult your local IBM representative for information on the products, services, and features available in your area.

Requests for technical information about IBM products should be made to your IBM reseller or IBM marketing representative.

© **Copyright International Business Machines Corporation 1999, 2000. All rights reserved.**  
Note to U.S. Government Users — Documentation related to restricted rights — Use, duplication or disclosure is subject to restrictions set forth in GSA ADP Schedule Contract with IBM Corp.

---

# Contents

**Safety: Read first** . . . . . iv

**Registering your option** . . . . . v

**About this book** . . . . . v

---

**Part 1: Installation, use, and maintenance guide** . . . . . 1-1

---

**Part 2: Appendixes** . . . . . 2-1

**Appendix A. Maintaining your tape drive** . . . . . 2-1

**Appendix B. Power-on self-test (POST) sequence** . . . . . 2-2

**Appendix C. Product specifications** . . . . . 2-3

**Appendix D. Problem solving** . . . . . 2-4

**Appendix E. Help and service information** . . . . . 2-6

Online technical support . . . . . 2-6

Telephone technical support . . . . . 2-6

**Appendix F. Product warranty and notices** . . . . . 2-8

Warranty Statements . . . . . 2-8

Notices . . . . . 2-17

Trademarks . . . . . 2-17

Electronic emission notices . . . . . 2-18

---

## Safety: Read first



Before installing this product, read the Safety Information.

Antes de instalar este produto, leia as Informações de Segurança.

在安装本产品之前，请仔细阅读 **Safety Information** (安全信息)。

Prije instalacije ovog produkta obavezno pročitajte Sigurnosne Upute.

Před instalací tohoto produktu si přečtěte příručku bezpečnostních instrukcí. Læs sikkerhedsforskrifterne, før du installerer dette produkt.

Ennen kuin asennat tämän tuotteen, lue turvaohjeet kohdasta Safety Information.

Avant d'installer ce produit, lisez les consignes de sécurité.

Vor der Installation dieses Produkts die Sicherheitshinweise lesen.

Πριν εγκαταστήσετε το προϊόν αυτό, διαβάστε τις πληροφορίες ασφάλειας (safety information).

A termék telepítése előtt olvassa el a Biztonsági előírásokat!  
Prima di installare questo prodotto, leggere le Informazioni sulla Sicurezza

製品の設置の前に、安全情報をお読みください。

본 제품을 설치하기 전에 안전 정보를 읽으십시오.

Пред да се инсталира овој продукт, прочитајте информацијата за безбедност.

Lees voordat u dit product installeert eerst de veiligheidsvoorschriften.

Les sikkerhetsinformasjonen (Safety Information) før du installerer dette produktet.

Przed zainstalowaniem tego produktu, należy zapoznać się z książką "Informacje dotyczące bezpieczeństwa" (Safety Information).

Antes de instalar este produto, leia as Informações sobre Segurança.

Перед установкой продукта прочтите инструкции по технике безопасности.

Pred inštaláciou tohto zariadenia si pečítajte Bezpečnostné predpisy.

Pred namestitvijo tega proizvoda preberite Varnostne informacije.

Antes de instalar este producto lea la información de seguridad.

Läs säkerhetsinformationen innan du installerar den här produkten.

安裝本產品之前，請先閱讀「安全資訊」。

---

## Registering your option

Thank you for purchasing OPTIONS by IBM®. Please take a few moments to register your product and provide us with information that will help IBM to better serve you in the future. Your feedback is valuable to us in developing products and services that are important to you, as well as in developing better ways to communicate with you. Register your option on the IBM Web site at:

<http://www.ibm.com/pc/register>

IBM will send you information and updates on your registered product unless you indicate on the Web site questionnaire that you do not want to receive further information.

---

## About this book

This manual contains information on the IBM 40/80 GB DLT Internal Tape Drive. It is divided into the following parts:

**Part 1:** Installation, use, and maintenance guide

This section contains the product description, installation and operating instructions, and maintenance information in the following languages: English, German, French, Spanish, Italian, Brazilian Portuguese, and Japanese.

**Part 2:** Appendixes

This section contains power-on self-test sequence, problem-solving, service, warranty, and notice information.

Be sure to retain your proof of purchase. It might be required for warranty service.

<p><b>Note:</b> The illustrations in this manual might be slightly different from your hardware.</p>
--



---

## Part 1: Installation, use, and maintenance guide

This guide contains product description, hardware and software installation instructions, and product use and maintenance information. For information on solving problems, see Appendix D, “Problem solving” on page 2-4.

---

### Product description

The 40/80 GB<sup>1</sup> DLT Internal Tape Drive is a fast/wide Ultra-2 (low voltage differential) tape drive for backing up and restoring data and archiving files. These files can include multimedia, imaging, transaction processing, large databases, and other storage-intensive applications. Each tape cartridge can store up to 40 GB of data (uncompressed), or up to 80 GB of data (compressed), assuming a 2:1 compression ratio.

In addition to this book, the option package contains:

- IBM 40/80 GB DLT Internal Tape Drive
- Mounting screws
- Jumpers
- Data cartridge
- Backup application CDs (trial versions)
- Safety Information manual

Contact your place of purchase if an item is missing or damaged. Be sure to retain your proof of purchase and packing material. They might be required to receive warranty service.

---

### Software description

The 40/80 GB DLT Internal Tape Drive includes trial-version backup application CDs. These CDs contain popular backup and restore applications for Microsoft® Windows NT®, Novell NetWare, and other operating systems. You can install the application you choose for your computer system by following the installation instructions that come with the CD you select. However, these trial versions of the software expire after 30 or 90 days, depending on the application you use.

You can use the trial period to determine the best application for your specific computer configuration. For information on purchasing a permanent installation copy of the desired tape drive backup application, go to the IBM tape drive Web site at

---

<sup>1</sup> GB equals approximately 1 000 000 000 bytes.

<http://www.ibm.com/pc/us/solutions/accessories/tapedrives.html> and follow the software links.

The CDs also contain backup applications that are used with other products but are not applicable to the 40/80 GB DLT Internal Tape Drive. Supported tape drive configurations can be found on the IBM Netfinity Server Compatibility Web page at <http://www.ibm.com/pc/compat>

---

## Installation requirements

To install this drive, you must have the following:

- Low voltage differential (Ultra2) SCSI host adapter, or a single-ended (SE) 3 SCSI host adapter
- Documentation for your computer, SCSI bus adapter, or external enclosure
- An Ultra2 LVD active terminator if you are installing the tape drive at the end of an Ultra2 LVD SCSI device chain<sup>2</sup>
- An SE active terminator if you are installing the tape drive at the end of an SE SCSI device chain<sup>3</sup>
- Phillips head and flat blade screwdrivers for the mounting screws, and for opening your computer
- Flat-nose pliers (optional) to install and remove jumpers
- An available 5.25-inch drive bay

---

## Installing the drive

This section contains information on installing the tape drive in IBM servers and in other computers.

---

<sup>2</sup> This tape drive can be installed on a single-ended (SE) SCSI device chain, but doing so might limit the performance of the drive.

<sup>3</sup> SCSI termination might be provided with your computer or SCSI adapter. Refer to the documentation that comes with your computer or SCSI adapter for more information.

<sup>4</sup> If you are using a Netfinity 8500, 8500R, or 7000 server, you must install the tape drive in a SCSI external storage enclosure such as the IBM 3551-001 or IBM 3503-BOX.



---

## Installing the drive in IBM servers

The tape drive is compatible with the Netfinity® 8500 or 8500R4, Netfinity 7000<sup>8</sup>, Netfinity 5500, and Netfinity 5000 servers. For instructions on installing the tape drive in a server, go to the “Installing Internal Drives” section in the server’s *User’s Handbook* and follow the directions for “Installing a 5.25-inch Removable-Media Drive.”

**Note:** The server *User’s Handbook* instructions refer specifically to installing a half-high drive in a single bay in the server. Your tape drive is a full-high drive and must be installed in *both* drive bays in the server.

---

## Installing the drive in other computers

Follow these steps to install the tape drive in other computers.

### Step 1. Selecting a SCSI ID

Each device on a SCSI bus must have a unique SCSI ID. You can select a SCSI ID from 0 to 6 for the tape drive. The SCSI ID must be supported by your SCSI adapter. Refer to your SCSI adapter documentation for the range and the relative priority of the IDs supported. The tape drive is shipped with the SCSI ID preset to 5.

Follow these guidelines to select a SCSI ID:

- Assign the tape drive to one of the higher priority IDs available (0–6).
- Assign the lower priority ID numbers (8–15) to those devices that are most often used or are faster than other devices in the chain.
- Do not assign an ID of 7, because this is usually used as the SCSI adapter ID.

Depending on your computer, there are several ways to view your current SCSI ID settings:

- For many IBM computers, press F1 during the startup after the memory check completes. Other adapters show SCSI settings when you press Ctrl+A. Check the documentation that comes with your computer or SCSI adapter for information on how to view configuration information.
- Use SCSI adapter utility programs, if available.
- Inspect the installed SCSI devices to see how the jumpers that determine the IDs are set.

### Step 2. Preparing for installation

To prepare for installation:

1. Turn off all attached devices. Turn off the computer. Unplug the power cords for the computer and all attached devices; then open the computer. For specific information on opening your computer, refer to the documentation that comes with your computer.

<p><b>Attention:</b> Tape drives are sensitive to static electricity discharge. The drives are wrapped in a static-protective bag to prevent damage.</p>
--

2. Before opening the static-protective bag containing the tape drive, touch the bag to an unpainted metal surface on the computer for at least two seconds. Remove the drive from the static-protective bag. If you must put the drive down, place the drive on the static-protective bag. Do not touch any exposed components of the tape drive. Instead, handle it carefully by the edges.

### Step 3. Setting the SCSI ID, termination, and parity

Use the following illustration to locate the SCSI configuration jumper blocks.

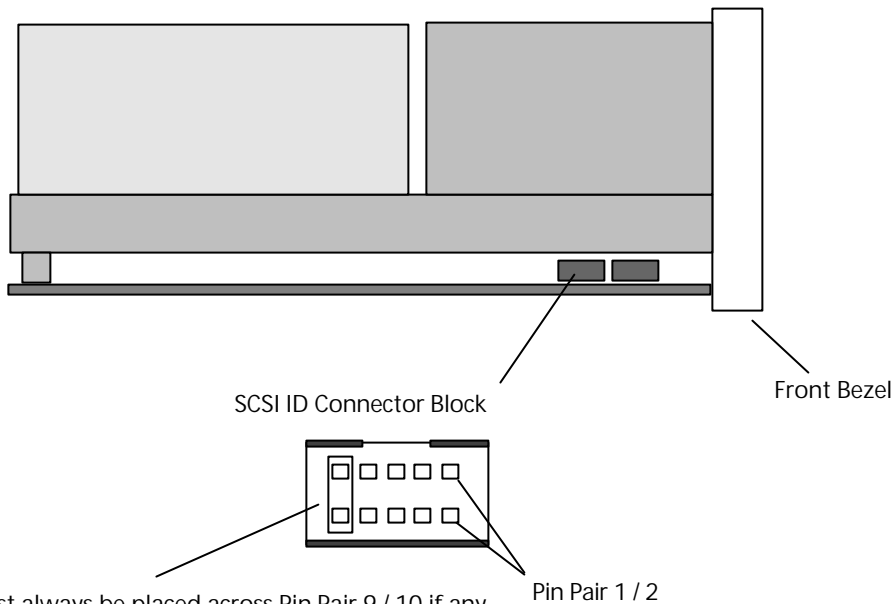

A jumper must always be placed across Pin Pair 9 / 10 if any SCSI ID other than the default (5) is selected.

If the tape drive is the last device on the SCSI bus, the bus must be terminated at the drive. Some SCSI cables provide self termination and do not require terminators. To terminate the bus at the drive, attach a SCSI terminator (not provided) to the drive connector before attaching the SCSI cable.

Most SCSI adapters provide termination power. However, if your SCSI adapter does not provide termination power, you must place a jumper in the **enable termination power** position on the jumper block. Attach a SCSI terminator (not provided) to the SCSI connector on the drive. For more information, refer to the documentation that comes with your computer or SCSI adapter.

If you install the tape drive in an SCSI external storage enclosure such as the IBM 3503-BOX storage enclosure, and the enclosure is at the end of the SCSI bus, refer to your enclosure documentation for information on termination.

Review the information that comes with your computer regarding parity generation. If your system does not generate parity, you can disable parity checking by placing a jumper in the **disable parity** position on the jumper block.

If you choose the default SCSI address of 5, proceed to Step 4. If you need to change the SCSI address, use the SCSI ID jumper block to set your SCSI ID. Remove and reposition jumpers to set the ID. If necessary, use a pair of flat-nose pliers to remove the jumpers. The following illustration shows how to set the jumper block for each ID. Use the jumpers that come with your tape drive.

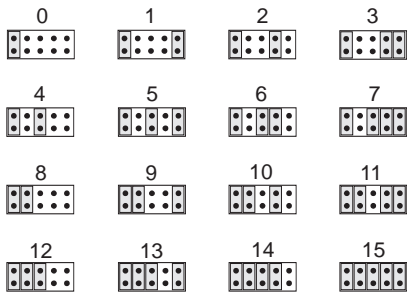

#### Step 4. Mounting the drive

Mount the tape drive; then attach the SCSI and power cables to it. If there is insufficient working space to attach the connectors after mounting the drive, attach the cables first (see “Step 5. Attaching cables” on page 1-19). To mount the drive:

1. Locate an available 5.25-inch bay or space in your computer to mount the tape drive. Remove the cover plate from the bay selected. Place the drive horizontally or vertically.
2. Align the drive-bay screw holes with the threaded holes in the drive housing. When you mount the tape drive, follow these guidelines:
  - Ensure that no objects such as screw heads, cables, or adjacent devices are pressing against the frame.
  - Ensure that nothing blocks the ventilation slots on the bottom and rear of the tape drive.
3. Insert a screw through each of the drive-bay holes into the threaded holes in the drive and tighten the screws with a screwdriver. Use only the screws that come with the tape drive. Other screws might be too long and cause electrical shorts.

#### Step 5. Attaching cables

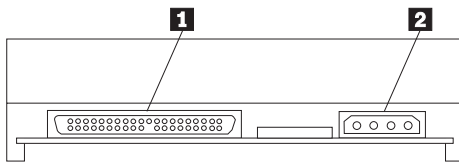

The rear tape drive connections are:

- 1** SCSI cable connector
- 2** Power connector

To attach the SCSI and power cables to the tape drive:

1. Locate the SCSI cable on your computer (a 68-pin (wide) ribbon cable with one end connected to the SCSI adapter) and find the next available connector that is farthest from the adapter. Use all empty bus connectors beginning with the one farthest from the adapter to ensure better signal quality.

**Note:** The SCSI adapter might be part of the computer system board or might be an adapter installed in an expansion slot.

2. Attach the SCSI cable from your computer to the tape drive 68-pin SCSI connector **1**. The SCSI cable connector at the end of the SCSI cable will attach to the drive only one way. Do not force the cable onto the drive.

**Attention:** Do not force the power cable into the tape drive power connector. If the power cable is upside down and you force the connection, you might damage the drive.

3. Connect the power cable connector to the four-pin connector **2** on the tape drive as shown in the illustration. If all the power cables are in use, purchase a dc Y-splitter cable, which is available at most electronics stores, and split a connection to make a connection available for the tape drive.

## Step 6. Completing the installation

Check your work before closing the computer.

1. Be sure that the power and SCSI connectors are securely attached. Be sure that the cables are neatly routed.
2. Replace the computer cover and secure it in place. Reconnect the power cords and cables.

## Step 7. Turning on the device

Turn on all attached devices; then turn on your computer. The tape drive performs a power-on self-test (POST) within 15 seconds and then performs a drive reset.

## Step 8. Updating the configuration

For most computers, the configuration-setup utility program automatically recognizes the new tape drive. However, you might have to provide information about your system changes after you restart your computer.

Ensure that the appropriate advanced SCSI programming interface (ASPI) device drivers are installed to support the tape drive. Device drivers are usually provided with the SCSI adapter.

If your computer does not recognize the tape drive after startup or you receive startup errors, run the configuration-setup utility program as described in the documentation that comes with your computer.

If all the indicators on either side of the tape drive blink in unison, there is a problem with the tape drive. Press the **Unload** button on the right side of the drive front panel to eject any tape that might be inserted and to reset the drive. If the problem persists, turn off the computer; then turn it back on. If the problem continues, see Appendix D, "Problem solving" on page 2-4 for further steps.

### Step 9. Installing backup and restore software

To use the drive, you must install an appropriate backup and restore application for your computer operating system. If you are using software not included in the option package, follow the directions that come with your software. If you are using the trial software that comes with the option, insert a trial application CD into the CD-ROM drive and follow the on-screen installation and operating instructions.

---

## Using the drive

The illustration shows the drive front panel.

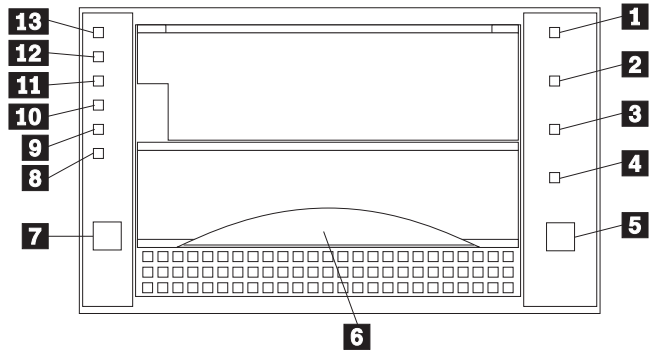

- 1 - 4** Status indicators
- 5** Unload button
- 6** Cartridge Insert/Release handle
- 7** Select button
- 8** Density Override indicator
- 9** Compress indicator
- 10 - 13** Tape Capacity indicators

---

## Understanding the status indicators

The indicators on the right side of the drive front panel are:

- 1 Write Protect** (orange): When this indicator is on, the tape is write protected.
- 2 Tape in Use** (yellow): When this indicator is blinking, the tape is in motion. When this indicator lights steadily, the tape is loaded and ready for use.
- 3 Use Cleaning Tape** (yellow): When this indicator is on, the drive head needs cleaning or the tape is damaged. For instructions on cleaning the drive, go to “Cleaning the drive” on page 1-13.
- 4 Operate Handle** (green): When this indicator lights steadily, you can lift the **Cartridge Insert/Release** handle. If the indicator is blinking, push the handle down and wait for the indicator to stop blinking.

---

## Using the controls

Use the controls listed below for unloading a tape, resetting the tape drive, inserting or releasing a cartridge, or cycling through tape capacity options.

- 5 Unload**: Press this button to unload a tape or to reset the tape drive.
- 6 Cartridge Insert/Release**: Lift this handle to insert or remove a cartridge when the **Operate Handle** indicator lights.
- 7 Select**: When the **Density Override** indicator **8** is flashing, you can press this button to cycle through tape capacity options.

---

## Reading the capacity indicators

The indicators on the left side of the front panel indicate current tape cartridge capacity in gigabytes, as well as any change in capacity you have requested. The type of data cartridge you use determines the capacities available for your selection. See “Selecting recording capacity” on page 1-11 for instructions on selecting recording capacity. See the “Maximum data capacity” table on page 2-3 for more details.

**Note:** Tape capacity cannot be changed mid-tape. To change tape capacity, the tape must be rewritten from the beginning.

- 8 Density Override** (yellow): When this indicator is lit, it indicates that you used the **Select** button to change tape capacity.
- 9 Compress** (yellow): When this indicator is lit, data compression is enabled.
- 10 40.0** (yellow): When this indicator lights steadily, the tape is recorded at 40.0 GB capacity. When this indicator is blinking, it indicates that you requested this capacity.
- 11 35.0** (yellow): When this indicator lights steadily, the tape is recorded at 35.0 GB capacity. When this indicator is blinking, it indicates that you requested this capacity.

**12 20.0** (yellow): When this indicator lights steadily, the tape is recorded at 20.0 GB capacity. When this light is blinking, it indicates that you requested this capacity.

**13 10.0/15.0** (yellow): When this indicator lights steadily, the tape is recorded at 10.0 GB or 15.0 GB capacity. When this indicator is blinking, it indicates you requested this capacity.

If the indicators flash in unison, it indicates a tape drive hardware failure. Try to reset the drive by following instructions given in “Resetting the drive” on page 1-14.

---

## Selecting data cartridges

For writing data, use only DLT data cartridges. Any of the following data cartridges are compatible with the tape drive and require no formatting or other media conditioning before use. For maximum data rate and storage capacities, use the IBM Data Cartridge (part number 59H3040) or Quantum DLTtape IV Cartridge.

- IBM Data Cartridge (part number 59H3040) - 40 GB capacity (80 GB compressed)
- DLTtape III - 10 GB original capacity (20 GB compressed)
- DLTtape IIIxt - 15 GB original capacity (30 GB compressed)
- DLTtape IV - 40 GB original capacity (80 GB compressed)

---

## Caring for tape cartridges

Use the following maintenance guidelines to properly handle your tape cartridges.

- Do not carry loose cartridges in a box or other container that exposes them to unnecessary physical shock.
- Store each cartridge vertically in its protective case when you are not using it.
- Do not drop or bump cartridge; this might dislodge or damage internal components.
- Avoid opening the cartridge door unnecessarily. Opening the cartridge door might expose the tape to contamination or physical damage.
- Do not allow anything to contact the tape medium or the tape leader. Dust or skin oils can contaminate the tape and hinder performance.
- Do not expose cartridges to moisture, direct sunlight, or condensation.
- Maintain clean operating, working, and storage environments.
- Do not place cartridges on or near devices that might produce magnetic fields, such as computer monitors, motors, or video equipment. Such exposure can alter or erase data on the tape. Magnetic fields are usually not a problem unless you place a tape cartridge a few inches from a magnet or an electric motor.
- Do not attempt to remove a tape cartridge from the tape system unless the **Operate Handle** indicator is lit steadily. Overriding the system handle causes damage to both the media and the tape drive.



- The ambient operating temperature for the tape cartridge is 10°C to 40°C (50°F to 104°F) and the ambient operating relative humidity (noncondensing) is 20% to 80%. If storage or transportation of a tape cartridge has exposed it to conditions outside these ambient values, allow the tape cartridge to acclimate to proper operating conditions for a 24-hour period before using.
- Place labels only in the front slide slot of the cartridge. Placing a label on the top, bottom, sides, or rear of the cartridge might interfere with normal cartridge operation and might damage other parts of the drive.
- Do not use graphite pencils, water-soluble felt pens, or other debris-producing writing instruments on your labels. Never use an eraser on a label; replace the label.
- Be sure to place unused cartridge labels in the protective box so that you do not inadvertently pick them up along with the cartridge during subsequent usage. A static electricity charge on a cartridge might cause a label to cling to the cartridge. If you accidentally insert a label into the system along with a cartridge, the hub reel and system gear might not mesh.
- Follow all instructions for tape cartridge handling that come with your cartridges or tape system.

---

## Selecting recording capacity

You might want to decrease tape capacity for compatibility with older tape drives, or increase capacity for enhanced performance. Insert a tape cartridge, and wait for tape motion to stop and the **Tape in Use** indicator to light steadily. The capacity indicators show the current tape capacity. If they are not lit, it means the tape is blank.

Press the **Select** button to change density. When the **Density Override** indicator is blinking, you can press the **Select** button to change the recording capacity of the tape. Press the **Select** button until the desired capacity indicator is flashing. The indicator will continue flashing until the tape drive begins recording in the new capacity. Then, the new capacity indicator lights steadily, and the original capacity indicator turns off.

**Note:** Your choice of capacities is limited by the data cartridge you use. See the “Maximum data capacity” table on page 2-3.

---

## Setting write protection on the cartridge

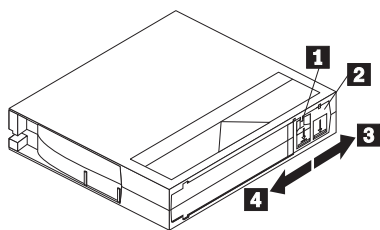

The front of the cartridge has an orange **write-protect** indicator **1**, and a **write-protect** switch **2** to prevent accidental erasure. Slide the switch to the right to write-enable **3** or to the left to write-protect **4**. You can change the **write-protect** switch before or after inserting the tape. If you change the write-protect switch while the tape is inserted, there is a delay of a few seconds before the **Write Protect** indicator on the tape drive changes.

**Note:** Your backup/restore software might also provide write-protection for the cartridge.

## Loading and unloading data cartridges

**Attention:** Turning on the drive with a tape inserted and the handle unlatched might damage the tape cartridge or tape drive.

When the yellow **Tape in Use** indicator is off and the green **Operate Handle** indicator is on, the tape drive is ready to accept a cartridge. If a cartridge is present during power-on self-test (POST) and the **Cartridge Insert/Release** handle is down, the tape drive will automatically load the tape once POST has completed.

To load a cartridge:

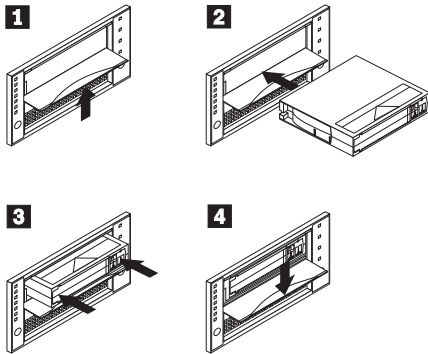

- 1** Be sure the **Operate Handle** indicator is on. Lift the **Cartridge Insert/Release** handle.
- 2** Position the cartridge with the **write-protect** switch facing you and to the right.
- 3** Insert the cartridge fully into the door.
- 4** Push the **Cartridge Insert/Release** handle down.

The tape drive loads the tape in approximately 20 seconds. The green **Operate Handle** indicator turns off and the yellow **Tape in Use** indicator flashes to show the tape is rewinding to the beginning. When the yellow **Tape in Use** indicator lights steadily, the tape drive is ready for read and write operations.

To unload a cartridge:

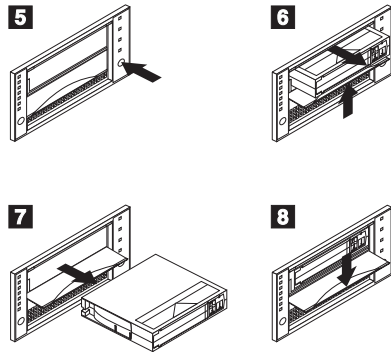

- 5** Press the **Unload** button and wait for the green **Operate Handle** indicator to light.
- 6** Lift the **Cartridge Insert/Release** handle up to pop the tape cartridge out.
- 7** Remove the tape cartridge from the drive.
- 8** Push the **Cartridge Insert/Release** handle down.

When you press the **Unload** button, the tape drive performs the following:

- Completes any command in process
- Writes any buffered information to tape
- Rewinds the tape to the beginning
- Turns the green **Operate Handle** indicator on

If an error occurs before or during the unloading process, the tape drive stops. To clear the error, press the **Unload** button again.

---

## Cleaning the drive

When the yellow **Use Cleaning Tape** indicator lights, the tape drive requires cleaning. Clean the drive as soon as possible.

To clean the tape drive, insert an IBM Cleaning Cartridge (part number 59H3092) or DLT Cleaning Tape. When cleaning is finished, the **Use Cleaning Tape** indicator turns off and the tape drive beeps. Press the **Unload** button and lift the **Cartridge Insert/Release** handle to remove the cleaning tape.

If the **Use Cleaning Tape** indicator does not turn off, it is possible that the cleaning cartridge has been used more than 20 times. Replace the used cartridge with a new one and repeat the cleaning process.

If the **Use Cleaning Tape** indicator lights while a data cartridge is in use and you have recently cleaned your drive, back up your data onto a new cartridge. Discard the original cartridge. It might be damaged.

---

## Resetting the drive

The reset procedure rewinds the tape and clears the buffer of previous tape drive commands and data. To reset the tape drive, press the **Unload** button, or turn the computer off and back on again.

If you reset the tape drive while a cartridge is loaded, the tape rewinds to the beginning. The reset might take as long as two minutes if the tape is positioned near the end. After the drive has been reset, tape operation starts from the beginning of the data cartridge. After resetting the drive, restart your backup tape software.

---

## Packing the drive for shipping

If you are shipping the tape drive to another location or returning it for repair, pack the tape drive in its original shipping container and packing materials.

**Attention:** To avoid damaging the tape drive, use the original shipping materials when you ship it. Your proof of purchase might be required to receive warranty service. If you are returning the tape drive for service, remove and keep all cartridges, cables, and terminators.

---

## Installation, use and maintenance guide (Translate)

This guide contains product description, hardware and software installation instructions, and product use and maintenance information.

---

### Product description

The 40/80 GB<sup>5</sup> DLT Internal Tape Drive is a fast/wide Ultra-2 (low voltage differential) tape drive for backing up and restoring data and archiving files. These files can include multimedia, imaging, transaction processing, large databases, and other storage-intensive applications. Each tape cartridge can store up to 40 GB of data (uncompressed), or up to 80 GB of data (compressed), assuming a 2:1 compression ratio.

In addition to this book, the option package contains:

- IBM 40/80 GB DLT Internal Tape Drive
- Mounting screws
- Jumpers
- Data cartridge
- Backup application CDs (trial versions)
- Safety Information manual

Contact your place of purchase if an item is missing or damaged. Be sure to retain your proof of purchase and packing material. They might be required to receive warranty service.

---

### Software description

The 40/80 GB DLT Internal Tape Drive includes trial-version backup application CDs. These CDs contain popular backup and restore applications for Microsoft® Windows NT®, Novell NetWare, and other operating systems. You can install the application you choose for your computer system by following the installation instructions that come with the CD you select. However, these trial versions of the software expire after 30 or 90 days, depending on the application you use.

You can use the trial period to determine the best application for your specific computer configuration. For information on purchasing a permanent installation copy of the desired tape drive backup application, go to the IBM tape drive Web site at <http://www.ibm.com/pc/us/solutions/accessories/tapedrives.html> and follow the software links.

---

<sup>5</sup> GB equals approximately 1 000 000 000 bytes.

The CDs also contain backup applications that are used with other products but are not applicable to the 40/80 GB DLT Internal Tape Drive. Supported tape drive configurations can be found on the IBM Netfinity Server Compatibility Web page at <http://www.ibm.com/pc/compat>

To install this drive, you must have the following:

- Low voltage differential (Ultra2) SCSI host adapter, or a single-ended (SE) 3 SCSI host adapter
- Documentation for your computer, SCSI bus adapter, or external enclosure
- An Ultra2 LVD active terminator if you are installing the tape drive at the end of an Ultra2 LVD SCSI device chain<sup>6</sup>
- An SE active terminator if you are installing the tape drive at the end of an SE SCSI device chain<sup>7</sup>
- Phillips head and flat blade screwdrivers for the mounting screws, and for opening your computer
- Flat-nose pliers (optional) to install and remove jumpers
- An available 5.25-inch drive bay

---

## Installing the drive

This section contains information on installing the tape drive in IBM servers and in other computers.

---

### Installing the drive in IBM servers

The tape drive is compatible with the Netfinity® 8500 or 8500R<sup>8</sup>, Netfinity 7000<sup>8</sup>, Netfinity 5500, and Netfinity 5000 servers. For instructions on installing the tape drive in a server, go to the “Installing Internal Drives” section in the server’s *User’s Handbook* and follow the directions for “Installing a 5.25-inch Removable-Media Drive.”

**Note:** The server *User’s Handbook* instructions refer specifically to installing a half-high drive in a single bay in the server. Your tape drive is a full-high drive and must be installed in *both* drive bays in the server.

---

<sup>6</sup> This tape drive can be installed on a single-ended (SE) SCSI device chain, but doing so might limit the performance of the drive.

<sup>7</sup> SCSI termination might be provided with your computer or SCSI adapter. Refer to the documentation that comes with your computer or SCSI adapter for more information.

<sup>8</sup> If you are using a Netfinity 8500, 8500R, or 7000 server, you must install the tape drive in a SCSI external storage enclosure such as the IBM 3551-001 or IBM 3503-BOX.

---

## Installing the drive in other computers

Follow these steps to install the tape drive in other computers.

### Step 1. Selecting a SCSI ID

Each device on a SCSI bus must have a unique SCSI ID. You can select a SCSI ID from 0 to 6 for the tape drive. The SCSI ID must be supported by your SCSI adapter. Refer to your SCSI adapter documentation for the range and the relative priority of the IDs supported. The tape drive is shipped with the SCSI ID preset to 5.

Follow these guidelines to select a SCSI ID:

- Assign the tape drive to one of the higher priority IDs available (0–6).
- Assign the lower priority ID numbers (8–15) to those devices that are most often used or are faster than other devices in the chain.
- Do not assign an ID of 7, because this is usually used as the SCSI adapter ID.

Depending on your computer, there are several ways to view your current SCSI ID settings:

- For many IBM computers, press F1 during the startup after the memory check completes. Other adapters show SCSI settings when you press Ctrl+A. Check the documentation that comes with your computer or SCSI adapter for information on how to view configuration information.
- Use SCSI adapter utility programs, if available.
- Inspect the installed SCSI devices to see how the jumpers that determine the IDs are set.

### Step 2. Preparing for installation

To prepare for installation:

1. Turn off all attached devices. Turn off the computer. Unplug the power cords for the computer and all attached devices; then open the computer. For specific information on opening your computer, refer to the documentation that comes with your computer.

<p><b>Attention:</b> Tape drives are sensitive to static electricity discharge. The drives are wrapped in a static-protective bag to prevent damage.</p>
--

2. Before opening the static-protective bag containing the tape drive, touch the bag to an unpainted metal surface on the computer for at least two seconds. Remove the drive from the static-protective bag. If you must put the drive down, place the drive on the static-protective bag. Do not touch any exposed components of the tape drive. Instead, handle it carefully by the edges.

### Step 3. Setting the SCSI ID, termination, and parity

Use the following illustration to locate the SCSI configuration jumper blocks.

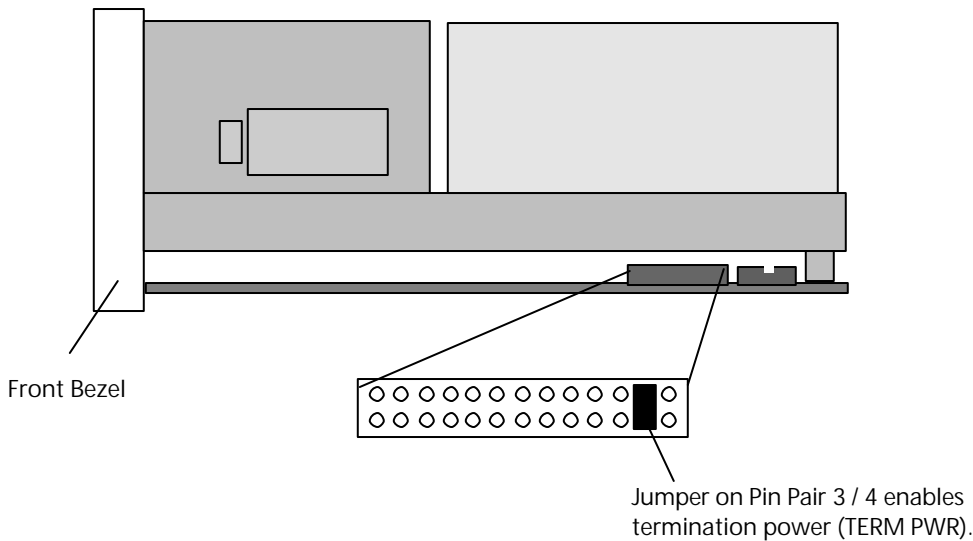

If the tape drive is the last device on the SCSI bus, the bus must be terminated at the drive. Some SCSI cables provide self termination and do not require terminators. To terminate the bus at the drive, attach a SCSI terminator (not provided) to the drive connector before attaching the SCSI cable.

Most SCSI adapters provide termination power. However, if your SCSI adapter does not provide termination power, you must place a jumper in the **enable termination power** position on the jumper block. Attach a SCSI terminator (not provided) to the SCSI connector on the drive. For more information, refer to the documentation that comes with your computer or SCSI adapter.

If you install the tape drive in a SCSI external storage enclosure such as the IBM 3503-BOX storage enclosure, and the enclosure is at the end of the SCSI bus, refer to your enclosure documentation for information on termination.

Review the information that comes with your computer regarding parity generation. If your system does not generate parity, you can disable parity checking by placing a jumper in the **disable parity** position on the jumper block.



If you choose the default SCSI address of 5, proceed to Step 4. If you need to change the SCSI address, use the SCSI ID jumper block to set your SCSI ID. Remove and reposition jumpers to set the ID. If necessary, use a pair of flat-nose pliers to remove the jumpers. The following illustration shows how to set the jumper block for each ID. Use the jumpers that come with your tape drive.

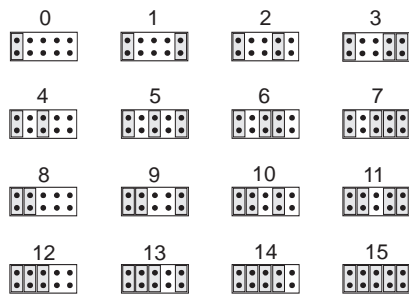

#### Step 4. Mounting the drive

Mount the tape drive; then attach the SCSI and power cables to it. If there is insufficient working space to attach the connectors after mounting the drive, attach the cables first (see “Step 5. Attaching cables”). To mount the drive:

1. Locate an available 5.25-inch bay or space in your computer to mount the tape drive. Remove the cover plate from the bay selected. Place the drive horizontally or vertically.
2. Align the drive-bay screw holes with the threaded holes in the drive housing. When you mount the tape drive, follow these guidelines:
  - Ensure that no objects such as screw heads, cables, or adjacent devices are pressing against the frame.
  - Ensure that nothing blocks the ventilation slots on the bottom and rear of the tape drive.
3. Insert a screw through each of the drive-bay holes into the threaded holes in the drive and tighten the screws with a screwdriver. Use only the screws that come with the tape drive. Other screws might be too long and cause electrical shorts.

#### Step 5. Attaching cables

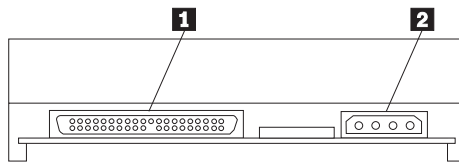

The rear tape drive connections are:

- 1** SCSI cable connector
- 2** Power connector

To attach the SCSI and power cables to the tape drive:

1. Locate the SCSI cable on your computer (a 68-pin (wide) ribbon cable with one end connected to the SCSI adapter) and find the next available connector that is farthest from the adapter. Use all empty bus connectors beginning with the one farthest from the adapter to ensure better signal quality.

**Note:** The SCSI adapter might be part of the computer system board or might be an adapter installed in an expansion slot.

2. Attach the SCSI cable from your computer to the tape drive 68-pin SCSI connector **1**. The SCSI cable connector at the end of the SCSI cable will attach to the drive only one way. Do not force the cable onto the drive.

**Attention:** Do not force the power cable into the tape drive power connector. If the power cable is upside down and you force the connection, you might damage the drive.

3. Connect the power cable connector to the four-pin connector **2** on the tape drive as shown in the illustration. If all the power cables are in use, purchase a dc Y-splitter cable, which is available at most electronics stores, and split a connection to make a connection available for the tape drive.

## Step 6. Completing the installation

Check your work before closing the computer.

1. Be sure that the power and SCSI connectors are securely attached. Be sure that the cables are neatly routed.
2. Replace the computer cover and secure it in place. Reconnect the power cords and cables.

## Step 7. Turning on the device

Turn on all attached devices; then turn on your computer. The tape drive performs a power-on self-test (POST) within 15 seconds and then performs a drive reset.

## Step 8. Updating the configuration

For most computers, the configuration-setup utility program automatically recognizes the new tape drive. However, you might have to provide information about your system changes after you restart your computer.

Ensure that the appropriate advanced SCSI programming interface (ASPI) device drivers are installed to support the tape drive. Device drivers are usually provided with the SCSI adapter.

If your computer does not recognize the tape drive after startup or you receive startup errors, run the configuration-setup utility program as described in the documentation that comes with your computer.

If all the indicators on either side of the tape drive blink in unison, there is a problem with the tape drive. Press the **Unload** button on the right side of the drive front panel to eject any tape that might be inserted and to reset the drive. If the problem persists, turn off the computer; then turn it back on. If the problem continues, see Appendix D, "Problem solving" on page 2-4 for further steps.

### Step 9. Installing backup and restore software

To use the drive, you must install an appropriate backup and restore application for your computer operating system. If you are using software not included in the option package, follow the directions that come with your software. If you are using the trial software that comes with the option, insert a trial application CD into the CD-ROM drive and follow the on-screen installation and operating instructions.

---

## Using the drive

The illustration shows the drive front panel.

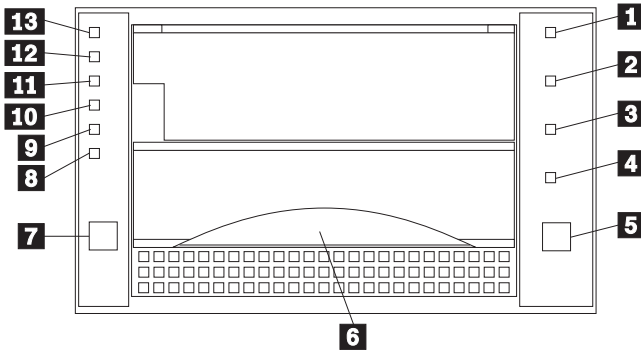

- 1 - 4** Status indicators
- 5** Unload button
- 6** Cartridge Insert/Release handle
- 7** Select button
- 8** Density Override indicator
- 9** Compress indicator
- 10 - 13** Tape Capacity indicators

---

## Understanding the status indicators

The indicators on the right side of the drive front panel are:

- 1 Write Protect** (orange): When this indicator is on, the tape is write protected.
- 2 Tape in Use** (yellow): When this indicator is blinking, the tape is in motion. When this indicator lights steadily, the tape is loaded and ready for use.
- 3 Use Cleaning Tape** (yellow): When this indicator is on, the drive head needs cleaning or the tape is damaged. For instructions on cleaning the drive, go to “Cleaning the drive” on page 1-26.
- 4 Operate Handle** (green): When this indicator lights steadily, you can lift the **Cartridge Insert/Release** handle. If the indicator is blinking, push the handle down and wait for the indicator to stop blinking.

---

## Using the controls

Use the controls listed below for unloading a tape, resetting the tape drive, inserting or releasing a cartridge, or cycling through tape capacity options.

- 5 Unload**: Press this button to unload a tape or to reset the tape drive.
- 6 Cartridge Insert/Release**: Lift this handle to insert or remove a cartridge when the **Operate Handle** indicator lights.
- 7 Select**: When the **Density Override** indicator **8** is flashing, you can press this button to cycle through tape capacity options.

---

## Reading the capacity indicators

The indicators on the left side of the front panel indicate current tape cartridge capacity in gigabytes, as well as any change in capacity you have requested. The type of data cartridge you use determines the capacities available for your selection. See “Selecting recording capacity” on page 1-24 for instructions on selecting recording capacity. See the “Maximum data capacity” table on page 2-3 for more details.

**Note:** Tape capacity cannot be changed mid-tape. To change tape capacity, the tape must be rewritten from the beginning.

- 8 Density Override** (yellow): When this indicator is lit, it indicates that you used the **Select** button to change tape capacity.
- 9 Compress** (yellow): When this indicator is lit, data compression is enabled.
- 10 40.0** (yellow): When this indicator lights steadily, the tape is recorded at 40.0 GB capacity. When this indicator is blinking, it indicates that you requested this capacity.
- 11 35.0** (yellow): When this indicator lights steadily, the tape is recorded at 35.0 GB capacity. When this indicator is blinking, it indicates that you requested this capacity.

**12 20.0** (yellow): When this indicator lights steadily, the tape is recorded at 20.0 GB capacity. When this light is blinking, it indicates that you requested this capacity.

**13 10.0/15.0** (yellow): When this indicator lights steadily, the tape is recorded at 10.0 GB or 15.0 GB capacity. When this indicator is blinking, it indicates you requested this capacity.

If the indicators flash in unison, it indicates a tape drive hardware failure. Try to reset the drive by following instructions given in “Resetting the drive” on page 1-27.

---

## Selecting data cartridges

For writing data, use only DLT data cartridges. Any of the following data cartridges are compatible with the tape drive and require no formatting or other media conditioning before use. For maximum data rate and storage capacities, use the IBM Data Cartridge (part number 59H3040) or Quantum DLTtape IV Cartridge.

- IBM Data Cartridge (part number 59H3040) - 40 GB capacity (80 GB compressed)
- DLTtape III - 10 GB original capacity (20 GB compressed)
- DLTtape IIIxt - 15 GB original capacity (30 GB compressed)
- DLTtape IV - 40 GB original capacity (80 GB compressed)

---

## Caring for tape cartridges

Use the following maintenance guidelines to properly handle your tape cartridges.

- Do not carry loose cartridges in a box or other container that exposes them to unnecessary physical shock.
- Store each cartridge vertically in its protective case when you are not using it.
- Do not drop or bump cartridge; this might dislodge or damage internal components.
- Avoid opening the cartridge door unnecessarily. Opening the cartridge door might expose the tape to contamination or physical damage.
- Do not allow anything to contact the tape medium or the tape leader. Dust or skin oils can contaminate the tape and hinder performance.
- Do not expose cartridges to moisture, direct sunlight, or condensation.
- Maintain clean operating, working, and storage environments.
- Do not place cartridges on or near devices that might produce magnetic fields, such as computer monitors, motors, or video equipment. Such exposure can alter or erase data on the tape. Magnetic fields are usually not a problem unless you place a tape cartridge a few inches from a magnet or an electric motor.
- Do not attempt to remove a tape cartridge from the tape system unless the **Operate Handle** indicator is lit steadily. Overriding the system handle causes damage to both the media and the tape drive.

- The ambient operating temperature for the tape cartridge is 10°C to 40°C (50°F to 104°F) and the ambient operating relative humidity (noncondensing) is 20% to 80%. If storage or transportation of a tape cartridge has exposed it to conditions outside these ambient values, allow the tape cartridge to acclimate to proper operating conditions for a 24-hour period before using.
- Place labels only in the front slide slot of the cartridge. Placing a label on the top, bottom, sides, or rear of the cartridge might interfere with normal cartridge operation and might damage other parts of the drive.
- Do not use graphite pencils, water-soluble felt pens, or other debris-producing writing instruments on your labels. Never use an eraser on a label; replace the label.
- Be sure to place unused cartridge labels in the protective box so that you do not inadvertently pick them up along with the cartridge during subsequent usage. A static electricity charge on a cartridge might cause a label to cling to the cartridge. If you accidentally insert a label into the system along with a cartridge, the hub reel and system gear might not mesh.
- Follow all instructions for tape cartridge handling that come with your cartridges or tape system.

---

## Selecting recording capacity

You might want to decrease tape capacity for compatibility with older tape drives, or increase capacity for enhanced performance. Insert a tape cartridge, and wait for tape motion to stop and the **Tape in Use** indicator to light steadily. The capacity indicators show the current tape capacity. If they are not lit, it means the tape is blank.

Press the **Select** button to change density. When the **Density Override** indicator is blinking, you can press the **Select** button to change the recording capacity of the tape. Press the **Select** button until the desired capacity indicator is flashing. The indicator will continue flashing until the tape drive begins recording in the new capacity. Then, the new capacity indicator lights steadily, and the original capacity indicator turns off.

**Note:** Your choice of capacities is limited by the data cartridge you use. See the “Maximum data capacity” table on page 2-3.

---

## Setting write protection on the cartridge

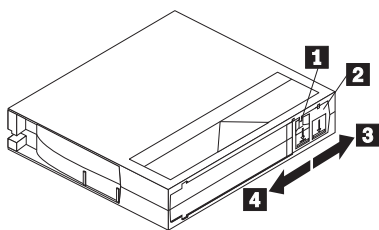

The front of the cartridge has an orange **write-protect** indicator **1**, and a **write-protect** switch **2** to prevent accidental erasure. Slide the switch to the right to write-enable **3** or to the left to write-protect **4**. You can change the **write-protect** switch before or after inserting the tape. If you change the write-protect switch while the tape is inserted, there is a delay of a few seconds before the **Write Protect** indicator on the tape drive changes.

**Note:** Your backup/restore software might also provide write-protection for the cartridge.

## Loading and unloading data cartridges

**Attention:** Turning on the drive with a tape inserted and the handle unlatched might damage the tape cartridge or tape drive.

When the yellow **Tape in Use** indicator is off and the green **Operate Handle** indicator is on, the tape drive is ready to accept a cartridge. If a cartridge is present during power-on self-test (POST) and the **Cartridge Insert/Release** handle is down, the tape drive will automatically load the tape once POST has completed.

To load a cartridge:

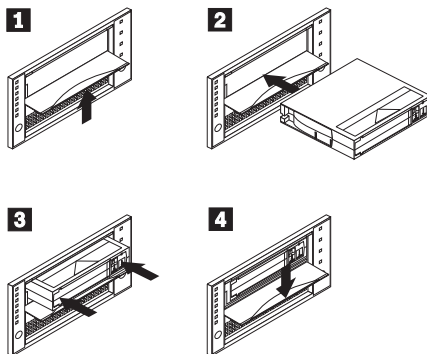

- 1** Be sure the **Operate Handle** indicator is on. Lift the **Cartridge Insert/Release** handle.
- 2** Position the cartridge with the **write-protect** switch facing you and to the right.
- 3** Insert the cartridge fully into the door.
- 4** Push the **Cartridge Insert/Release** handle down.

The tape drive loads the tape in approximately 20 seconds. The green **Operate Handle** indicator turns off and the yellow **Tape in Use** indicator flashes to show the tape is rewinding to the beginning. When the yellow **Tape in Use** indicator lights steadily, the tape drive is ready for read and write operations.

To unload a cartridge:

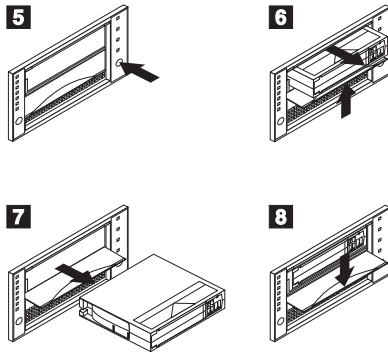

- 5** Press the **Unload** button and wait for the green **Operate Handle** indicator to light.
- 6** Lift the **Cartridge Insert/Release** handle up to pop the tape cartridge out.
- 7** Remove the tape cartridge from the drive.
- 8** Push the **Cartridge Insert/Release** handle down.

When you press the **Unload** button, the tape drive performs the following:

- Completes any command in process
- Writes any buffered information to tape
- Rewinds the tape to the beginning
- Turns the green **Operate Handle** indicator on

If an error occurs before or during the unloading process, the tape drive stops. To clear the error, press the **Unload** button again.

---

## Cleaning the drive

When the yellow **Use Cleaning Tape** indicator lights, the tape drive requires cleaning. Clean the drive as soon as possible.

To clean the tape drive, insert an IBM Cleaning Cartridge (part number 59H3092) or DLT Cleaning Tape. When cleaning is finished, the **Use Cleaning Tape** indicator turns off and the tape drive beeps. Press the **Unload** button and lift the **Cartridge Insert/Release** handle to remove the cleaning tape.

If the **Use Cleaning Tape** indicator does not turn off, it is possible that the cleaning cartridge has been used more than 20 times. Replace the used cartridge with a new one and repeat the cleaning process.

If the **Use Cleaning Tape** indicator lights while a data cartridge is in use and you have recently cleaned your drive, back up your data onto a new cartridge. Discard the original cartridge. It might be damaged.



---

## Resetting the drive

The reset procedure rewinds the tape and clears the buffer of previous tape drive commands and data. To reset the tape drive, press the **Unload** button, or turn the computer off and back on again.

If you reset the tape drive while a cartridge is loaded, the tape rewinds to the beginning. The reset might take as long as two minutes if the tape is positioned near the end. After the drive has been reset, tape operation starts from the beginning of the data cartridge. After resetting the drive, restart your backup tape software.

---

## Packing the drive for shipping

If you are shipping the tape drive to another location or returning it for repair, pack the tape drive in its original shipping container and packing materials.

<p><b>Attention:</b> To avoid damaging the tape drive, use the original shipping materials when you ship it. Your proof of purchase might be required to receive warranty service. If you are returning the tape drive for service, remove and keep all cartridges, cables, and terminators.</p>
--

Thank you for purchasing OPTIONS by IBM®. Please take a few moments to register your product and provide us with information that will help IBM to better serve you in the future. Your feedback is valuable to us in developing products and services that are important to you, as well as in developing better ways to communicate with you. Register your option on the IBM Web site at:

<http://www.ibm.com/pc/register>

IBM will send you information and updates on your registered product unless you indicate on the Web site questionnaire that you do not want to receive further information.



---

## Part 2: Appendixes

The following appendixes contain the POST sequence, product specifications, problem-solving information, help and service information, the product warranty, and notices.

---

### Appendix A. Maintaining your tape drive

This section contains important information about maintaining your tape drive and caring for your storage media.

#### Tape handling and storage

Most tape is supplied in a sealed cartridge. Tape is provided this way so that the tape will remain in a clean environment. Opening the cartridge allows dirt and airborne particles to enter and then become a source of contamination. The cartridge must only be opened by the tape drive and not by an operator. The tape is also held under proper tension inside the cartridge. If the cartridge is dropped, this tension is relaxed. Inserting a dropped cartridge into a tape drive can often cause a mis-load that results in a jam. The jam ruins the tape and can cause physical damage if the cartridge is not removed properly. When the tapes are stored, they must be reinstalled into their protective containers and stored on their ends. You must store the tapes in a clean, dry area with normal room temperature, and away from magnetic fields.

#### Environmental issues

The operating environment might adversely affect tape drive operation. The tape drive is designed to operate in a clean environment. When tape is installed in a tape drive, the clearance between the heads and the tape is measured in microns. Even particles of smoke are larger than the space available between the tape and the heads. Other environmental factors that adversely affect tape drive operation are dirt, dust, fibers, and airborne particles.

#### Tape drive cleaning

Even if the operating environment is clean, dirt might build up on the heads of any tape drive. Every time tape motion occurs, some of the media surface comes off on the heads. Over time, this material builds up and causing the tape head clearance to increase. The increased tape head clearance produces reading and writing errors. Most tape drives today have a built-in cleaning indicator to notify you when the tape needs cleaning.

Do not use any non-IBM cleaning cartridges with these tape drives. You can only use cleaning cartridges for a limited number of times. A cleaning cartridge is expired after it has been used for the maximum number of times. When a cleaning cartridge is expired, you must replace it. Never reuse an expired cleaning cartridge. If you continue to use an expired cleaning cartridge, you will reintroduce previously removed dirt to the tape drive and you will not clean the drive. To make sure that you know

when your cleaning cartridge expires, make a notation on the cleaning cartridge each time you clean the tape drive.

---

## Appendix B. Power-on self-test (POST) sequence

When the 40/80 GB DLT Internal Tape Drive is first turned on and there is no cartridge loaded, the indicators on the front panel light in the following sequence:

1. Each of the device status indicators on the right side lights briefly, starting from top to bottom.
2. All of the indicators on the left side turn on at the same time and remain lit for three seconds before turning off.
3. The **Operate Handle**, **Write Protect**, and **Use Cleaning Tape** indicators turn off.
4. The **Tape in Use** indicator blinks while the drive initializes.
5. Then one of the following sequences occur:
  - If a tape is not loaded:
    - a. The **Tape in Use** indicator turns off.
    - b. The **Operate Handle** indicator turns on.
    - c. The **Cartridge Insert/Release** handle unlatches.
    - d. The beeper sounds.
  - If a tape is loaded:
    - a. The drive loads the tape.
    - b. The **Tape in Use** indicator stops blinking and stays on.
    - c. The indicator showing the tape's current capacity lights. (No lights indicate the tape is blank. If you do not select a capacity, the default capacity is used.)
    - d. The **Density Override** indicator blinks.

**Attention:** If you turn on the drive with a tape inserted and the handle unlatched, you might damage the tape or drive.

- If a cartridge is loaded, but the **Cartridge Release/Insert** handle is up:
  - a. The **Tape in Use** indicator turns off.
  - b. The **Operate Handle** indicator flashes.
  - c. You must lower the handle to load the cartridge.
- If the **Cartridge Release/Insert** handle is up with no cartridge inserted:
  - a. The **Operate Handle** indicator flashes.
  - b. Push the **Cartridge Release/Insert** handle down.
  - c. Wait for the **Operate Handle** indicator to light steadily.
- If the drive detects an error condition:
  - a. The indicators on the right or left flash repeatedly in unison.
  - b. Press the **Unload** button and wait for the drive to reinitialize.
  - c. If the drive does not reset, turn it off, then on.

---

## Appendix C. Product specifications

This appendix includes the product specifications and requirements.

<i>Physical specifications</i>	
Height (with bezel)	86.3 mm (3.4 in)
Width (with bezel)	148.3 mm (5.84 in)
Length (with bezel)	243.8 mm (9.6 in)
Weight	2.9 Kg. (6 lb, 7 oz)

<i>Maximum data capacity</i>		
<b>Tape</b>	<b>Uncompressed Data</b>	<b>Compressed Data<sup>9</sup></b>
DLTtape III	10 GB <sup>10</sup>	20 GB
DLTtape IIIxt	15 GB	30 GB
DLTtape IV	40 GB	80 GB
IBM Data Cartridge (part number 59H3040)	40 GB	80 GB

<i>Input voltages</i>
Standard +5 V dc and +12 V dc $\pm 5\%$

<i>Maximum sustained data-transfer rates</i>	
Compressed data	10 MB <sup>11</sup> per second
Uncompressed data	6 MB per second

<i>Power</i>	
+5 V ( $\pm 5\%$ )	3.8 A (max)
+12 V ( $\pm 5\%$ )	2.6 A (max)
Total	70 W (max)

---

<sup>9</sup> This assumes a 2:1 compression ratio.

<sup>10</sup> GB equals approximately 1 000 000 000 bytes.

<sup>11</sup> MB equals approximately 1 000 000 bytes.

<i>Operating environment</i>	
Tape path temperature range	+10°C to +40°C (+50°F to +104°F)
Relative humidity	20% to 80%, noncondensing
Wet bulb	25°C (77°F) maximum
Altitude	-152 to +12 192 m (-500 to +40 000 ft)
Temperature gradient	11°C per hour
Humidity gradient	10% per hour

<i>SCSI cable specifications</i>	
Connector	68-pin male, shielded, AMP 786090-7
Maximum length	3 m (10 ft)

---

## Appendix D. Problem solving

Computer problems can be caused by hardware, software, or user error. You might be able to use the information in this section to solve problems yourself, or gather helpful information you can pass on to a service technician.

Review the following list for any problem descriptions that might fit your situation.

- **The software does not recognize the tape drive.**

Take the following actions:

1. Check for proper termination of the SCSI device chain. The SCSI device chain must be terminated at both ends.
2. Check for conflicting SCSI ID settings. Each SCSI ID must be unique on the SCSI device chain.
3. Ensure that the appropriate Advanced SCSI Programming Interface (ASPI) device drivers are installed to support the tape drive. ASPI device drivers usually come with the SCSI host adapter. For more information on the device drivers, see the documentation that came with your SCSI host adapter or your computer system.

- **The tape drive does not operate and the amber indicator is flashing**

Take the following action:

Three sets of numbers display on the LCD showing the most recent three errors. The first two digits in error 1 are the fault symptom code. Keep this fault symptom code for reference, and call the HelpCenter. to help resolve the problem.

- **The tape operation is unreliable or inconsistent.**

Tape drive failures are often caused by contamination in the tape path or by using poor quality media.

IBM has very high quality standards for its storage tape and prices it accordingly. To be able to support tape products, IBM needs to constantly test and evaluate. However, IBM does not test and evaluate non-IBM products on an ongoing basis. IBM cannot support any product it does not test. IBM can only support tapes sold by IBM. If IBM service personnel analysis indicates a problem with non-IBM media, including cleaning cartridges, it might be necessary for the customer to replace the suspect media or cleaning cartridge with the supported media or cleaning cartridge. When you need to restore data from tape, you need to know that you can count on it being readable. Any savings incurred by using low cost tape is of no value when you cannot access the data reliably.

---

## Appendix E. Help and service information

See Appendix D, “Problem solving” on page 2-4 before requesting help or service.

This section contains information on how to obtain online and telephone technical support.

---

### Online technical support

Online technical support is available during the life of your product. Online assistance can be obtained through the Personal Computing Support Web site and the IBM Automated Fax System.

<i>Online technical support</i>	
IBM Personal Computing Support Web Site	<a href="http://www.ibm.com/pc/support">http://www.ibm.com/pc/support</a>
IBM Automated Fax System	1-800-426-3395 (U.S. and Canada)

During the warranty period, assistance for replacement or exchange of defective components is available. In addition, if your IBM option is installed in an IBM computer, you might be entitled to service at your location. Your technical support representative can help you determine the best alternative.

---

### Telephone technical support

Marketing, installation, and configuration support through the HelpCenter will be withdrawn or made available for a fee, at IBM’s discretion, 90 days after the option has been withdrawn from marketing. Additional support offerings, including step-by-step installation assistance, are available for a nominal fee.

To assist the technical support representative, have available as much of the following information as possible:

1. Option name
2. Option number
3. Proof of purchase
4. Computer manufacturer, model, serial number (if IBM), and manual
5. Exact wording of the error message (if any)
6. Description of the problem
7. Hardware and software configuration information for your system

If possible, be at your computer. Your technical support representative might want to walk you through the problem during the call.



For the support telephone number and support hours by country, refer to the following table or to the enclosed technical support insert. If the number is not provided, contact your IBM reseller or IBM marketing representative. Response time may vary depending on the number and nature of the calls received.

<i>Support 24 hours a day, 7 days a week</i>	
Canada	1-800-565-3344
U.S.A./Puerto Rico	1-800-772-2227

°

---

## Appendix F. Product warranty and notices

---

### Warranty Statements

The warranty statements consist of two parts: Part 1 and Part 2. Part 1 varies by country. Part 2 is the same for both statements. Be sure to read both the Part 1 that applies to your country and Part 2.

- **United States, Puerto Rico, and Canada (Z125-4753-05 11/97)**  
(Part 1 - General Terms on page 2-8)
- **Worldwide except Canada, Puerto Rico, Turkey, and United States (Z125-5697-01 11/97)**  
(Part 1 - General Terms on page 2-11)
- **Worldwide Country-Unique Terms**  
(Part 2 - Country-Unique Terms on page 2-13)

### IBM Statement of Limited Warranty for United States, Puerto Rico, and Canada (Part 1 - General Terms)

---

*This Statement of Limited Warranty includes Part 1 - General Terms and Part 2 - Country-unique Terms. The terms of Part 2 may replace or modify those of Part 1. The warranties provided by IBM in this Statement of Limited Warranty apply only to Machines you purchase for your use, and not for resale, from IBM or your reseller. The term "Machine" means an IBM machine, its features, conversions, upgrades, elements, or accessories, or any combination of them. The term "Machine" does not include any software programs, whether pre-loaded with the Machine, installed subsequently or otherwise. Unless IBM specifies otherwise, the following warranties apply only in the country where you acquire the Machine. Nothing in this Statement of Warranty affects any statutory rights of consumers that cannot be waived or limited by contract. If you have any questions, contact IBM or your reseller.*

**Machine** - 40/80 GB DLT Internal Tape Drive

**Warranty Period\*** - Three Years

*\*Contact your place of purchase for warranty service information. Some IBM Machines are eligible for On-site warranty service depending on the country where service is performed.*

### The IBM Warranty for Machines

IBM warrants that each Machine 1) is free from defects in materials and workmanship and 2) conforms to IBM's Official Published Specifications. The warranty period for a Machine is a specified, fixed period commencing on its Date of Installation. The date on your sales receipt is the Date of Installation, unless IBM or your reseller informs you otherwise.

During the warranty period IBM or your reseller, if approved by IBM to provide warranty service, will provide repair and exchange service for the Machine, without charge, under the type of service designated for the Machine and will manage and install engineering changes that apply to the Machine.

If a Machine does not function as warranted during the warranty period, and IBM or your reseller are unable to either 1) make it do so or 2) replace it with one that is at least functionally

equivalent, you may return it to your place of purchase and your money will be refunded. The replacement may not be new, but will be in good working order.

### **Extent of Warranty**

The warranty does not cover the repair or exchange of a Machine resulting from misuse, accident, modification, unsuitable physical or operating environment, improper maintenance by you, or failure caused by a product for which IBM is not responsible. The warranty is voided by removal or alteration of Machine or parts identification labels.

**THESE WARRANTIES ARE YOUR EXCLUSIVE WARRANTIES AND REPLACE ALL OTHER WARRANTIES OR CONDITIONS, EXPRESS OR IMPLIED, INCLUDING, BUT NOT LIMITED TO, THE IMPLIED WARRANTIES OR CONDITIONS OF MERCHANTABILITY AND FITNESS FOR A PARTICULAR PURPOSE. THESE WARRANTIES GIVE YOU SPECIFIC LEGAL RIGHTS AND YOU MAY ALSO HAVE OTHER RIGHTS WHICH VARY FROM JURISDICTION TO JURISDICTION. SOME JURISDICTIONS DO NOT ALLOW THE EXCLUSION OR LIMITATION OF EXPRESS OR IMPLIED WARRANTIES, SO THE ABOVE EXCLUSION OR LIMITATION MAY NOT APPLY TO YOU. IN THAT EVENT, SUCH WARRANTIES ARE LIMITED IN DURATION TO THE WARRANTY PERIOD. NO WARRANTIES APPLY AFTER THAT PERIOD.**

### **Items Not Covered by Warranty**

IBM does not warrant uninterrupted or error-free operation of a Machine.

Unless specified otherwise, IBM provides non-IBM machines **WITHOUT WARRANTIES OF ANY KIND.**

Any technical or other support provided for a Machine under warranty, such as assistance via telephone with “how-to” questions and those regarding Machine set-up and installation, will be provided **WITHOUT WARRANTIES OF ANY KIND.**

### **Warranty Service**

To obtain warranty service for the Machine, contact your reseller or IBM. In the United States, call IBM at 1-800-772-2227. In Canada, call IBM at 1-800-565-3344. You may be required to present proof of purchase.

IBM or your reseller provides certain types of repair and exchange service, either at your location or at a service center, to keep Machines in, or restore them to, conformance with their Specifications. IBM or your reseller will inform you of the available types of service for a Machine based on its country of installation. IBM may repair the failing Machine or exchange it at its discretion.

When warranty service involves the exchange of a Machine or part, the item IBM or your reseller replaces becomes its property and the replacement becomes yours. You represent that all removed items are genuine and unaltered. The replacement may not be new, but will be in good working order and at least functionally equivalent to the item replaced. The replacement assumes the warranty service status of the replaced item.

Any feature, conversion, or upgrade IBM or your reseller services must be installed on a Machine which is 1) for certain Machines, the designated, serial-numbered Machine and 2) at an engineering-change level compatible with the feature, conversion, or upgrade. Many features, conversions, or upgrades involve the removal of parts and their return to IBM. A part that replaces a removed part will assume the warranty service status of the removed part.

Before IBM or your reseller exchanges a Machine or part, you agree to remove all features, parts, options, alterations, and attachments not under warranty service.

You also agree to

1. ensure that the Machine is free of any legal obligations or restrictions that prevent its exchange;
2. obtain authorization from the owner to have IBM or your reseller service a Machine that you do not own; and
3. where applicable, before service is provided
  - a. follow the problem determination, problem analysis, and service request procedures that IBM or your reseller provides,
  - b. secure all programs, data, and funds contained in a Machine,
  - c. provide IBM or your reseller with sufficient, free, and safe access to your facilities to permit them to fulfill their obligations, and
  - d. inform IBM or your reseller of changes in a Machine's location.

IBM is responsible for loss of, or damage to, your Machine while it is 1) in IBM's possession or 2) in transit in those cases where IBM is responsible for the transportation charges.

Neither IBM nor your reseller is responsible for any of your confidential, proprietary or personal information contained in a Machine which you return to IBM or your reseller for any reason.

You should remove all such information from the Machine prior to its return.

### **Production Status**

Each IBM Machine is manufactured from new parts, or new and used parts. In some cases, the Machine may not be new and may have been previously installed. Regardless of the Machine's production status, IBM's appropriate warranty terms apply.

### **Limitation of Liability**

Circumstances may arise where, because of a default on IBM's part or other liability, you are entitled to recover damages from IBM. In each such instance, regardless of the basis on which you are entitled to claim damages from IBM (including fundamental breach, negligence, misrepresentation, or other contract or tort claim), IBM is liable for no more than

1. damages for bodily injury (including death) and damage to real property and tangible personal property; and
2. the amount of any other actual direct damages, up to the greater of U.S. \$100,000 (or equivalent in local currency) or the charges (if recurring, 12 months' charges apply) for the Machine that is the subject of the claim.

This limit also applies to IBM's suppliers and your reseller. It is the maximum for which IBM, its suppliers, and your reseller are collectively responsible.

**UNDER NO CIRCUMSTANCES IS IBM LIABLE FOR ANY OF THE FOLLOWING: 1) THIRD-PARTY CLAIMS AGAINST YOU FOR DAMAGES (OTHER THAN THOSE UNDER THE FIRST ITEM LISTED ABOVE); 2) LOSS OF, OR DAMAGE TO, YOUR RECORDS OR DATA; OR 3) SPECIAL, INCIDENTAL, OR INDIRECT DAMAGES OR FOR ANY ECONOMIC CONSEQUENTIAL DAMAGES (INCLUDING LOST PROFITS OR SAVINGS), EVEN IF IBM, ITS SUPPLIERS OR YOUR RESELLER IS INFORMED OF THEIR POSSIBILITY. SOME JURISDICTIONS DO NOT ALLOW THE EXCLUSION OR LIMITATION OF INCIDENTAL OR CONSEQUENTIAL DAMAGES, SO THE ABOVE LIMITATION OR EXCLUSION MAY NOT APPLY TO YOU.**

## **IBM Statement of Warranty Worldwide except Canada, Puerto Rico, Turkey, United States (Part 1 - General Terms)**

*This Statement of Warranty includes Part 1 - General Terms and Part 2 - Country-unique Terms. The terms of Part 2 may replace or modify those of Part 1. The warranties provided by IBM in this Statement of Warranty apply only to Machines you purchase for your use, and not for resale, from IBM or your reseller. The term "Machine" means an IBM machine, its features, conversions, upgrades, elements, or accessories, or any combination of them. The term "Machine" does not include any software programs, whether pre-loaded with the Machine, installed subsequently or otherwise. Unless IBM specifies otherwise, the following warranties apply only in the country where you acquire the Machine. Nothing in this Statement of Warranty affects any statutory rights of consumers that cannot be waived or limited by contract. If you have any questions, contact IBM or your reseller.*

**Machine** - 40/80 GB DLT Internal Tape Drive

**Warranty Period\*** - Three Years

*\*Contact your place of purchase for warranty service information. Some IBM Machines are eligible for On-site warranty service depending on the country where service is performed.*

### **The IBM Warranty for Machines**

IBM warrants that each Machine 1) is free from defects in materials and workmanship and 2) conforms to IBM's Official Published Specifications. The warranty period for a Machine is a specified, fixed period commencing on its Date of Installation. The date on your sales receipt is the Date of Installation, unless IBM or your reseller informs you otherwise.

During the warranty period IBM or your reseller, if approved by IBM to provide warranty service, will provide repair and exchange service for the Machine, without charge, under the type of service designated for the Machine and will manage and install engineering changes that apply to the Machine.

If a Machine does not function as warranted during the warranty period, and IBM or your reseller are unable to either 1) make it do so or 2) replace it with one that is at least functionally equivalent, you may return it to your place of purchase and your money will be refunded. The replacement may not be new, but will be in good working order.

### **Extent of Warranty**

The warranty does not cover the repair or exchange of a Machine resulting from misuse, accident, modification, unsuitable physical or operating environment, improper maintenance by you, or failure caused by a product for which IBM is not responsible. The warranty is voided by removal or alteration of Machine or parts identification labels.

**THESE WARRANTIES ARE YOUR EXCLUSIVE WARRANTIES AND REPLACE ALL OTHER WARRANTIES OR CONDITIONS, EXPRESS OR IMPLIED, INCLUDING, BUT NOT LIMITED TO, THE IMPLIED WARRANTIES OR CONDITIONS OF MERCHANTABILITY AND FITNESS FOR A PARTICULAR PURPOSE. THESE WARRANTIES GIVE YOU SPECIFIC LEGAL RIGHTS AND YOU MAY ALSO HAVE OTHER RIGHTS WHICH VARY FROM JURISDICTION TO JURISDICTION. SOME JURISDICTIONS DO NOT ALLOW THE EXCLUSION OR LIMITATION OF EXPRESS OR IMPLIED WARRANTIES, SO THE ABOVE EXCLUSION OR**

**LIMITATION MAY NOT APPLY TO YOU. IN THAT EVENT, SUCH WARRANTIES ARE LIMITED IN DURATION TO THE WARRANTY PERIOD. NO WARRANTIES APPLY AFTER THAT PERIOD.**

#### **Items Not Covered by Warranty**

IBM does not warrant uninterrupted or error-free operation of a Machine.

Unless specified otherwise, IBM provides non-IBM machines **WITHOUT WARRANTIES OF ANY KIND.**

Any technical or other support provided for a Machine under warranty, such as assistance via telephone with "how-to" questions and those regarding Machine set-up and installation, will be provided **WITHOUT WARRANTIES OF ANY KIND.**

#### **Warranty Service**

To obtain warranty service for the Machine, contact your reseller or IBM. You may be required to present proof of purchase.

IBM or your reseller provides certain types of repair and exchange service, either at your location or at a service center, to keep Machines in, or restore them to, conformance with their Specifications. IBM or your reseller will inform you of the available types of service for a Machine based on its country of installation. IBM may repair the failing Machine or exchange it at its discretion.

When warranty service involves the exchange of a Machine or part, the item IBM or your reseller replaces becomes its property and the replacement becomes yours. You represent that all removed items are genuine and unaltered. The replacement may not be new, but will be in good working order and at least functionally equivalent to the item replaced. The replacement assumes the warranty service status of the replaced item.

Any feature, conversion, or upgrade IBM or your reseller services must be installed on a Machine which is 1) for certain Machines, the designated, serial-numbered Machine and 2) at an engineering-change level compatible with the feature, conversion, or upgrade. Many features, conversions, or upgrades involve the removal of parts and their return to IBM. A part that replaces a removed part will assume the warranty service status of the removed part.

Before IBM or your reseller exchanges a Machine or part, you agree to remove all features, parts, options, alterations, and attachments not under warranty service.

You also agree to

1. ensure that the Machine is free of any legal obligations or restrictions that prevent its exchange;
2. obtain authorization from the owner to have IBM or your reseller service a Machine that you do not own; and
3. where applicable, before service is provided
  - a. follow the problem determination, problem analysis, and service request procedures that IBM or your reseller provides,
  - b. secure all programs, data, and funds contained in a Machine,
  - c. provide IBM or your reseller with sufficient, free, and safe access to your facilities to permit them to fulfil their obligations, and
  - d. inform IBM or your reseller of changes in a Machine's location.

IBM is responsible for loss of, or damage to, your Machine while it is 1) in IBM's possession or 2) in transit in those cases where IBM is responsible for the transportation charges.

Neither IBM nor your reseller is responsible for any of your confidential, proprietary or personal information contained in a Machine which you return to IBM or your reseller for any reason. You should remove all such information from the Machine prior to its return.

### **Production Status**

Each IBM Machine is manufactured from new parts, or new and used parts. In some cases, the Machine may not be new and may have been previously installed. Regardless of the Machine's production status, IBM's appropriate warranty terms apply.

### **Limitation of Liability**

Circumstances may arise where, because of a default on IBM's part or other liability, you are entitled to recover damages from IBM. In each such instance, regardless of the basis on which you are entitled to claim damages from IBM (including fundamental breach, negligence, misrepresentation, or other contract or tort claim), IBM is liable for no more than

1. damages for bodily injury (including death) and damage to real property and tangible personal property; and
2. the amount of any other actual direct damages, up to the greater of U.S. \$100,000 (or equivalent in local currency) or the charges (if recurring, 12 months' charges apply) for the Machine that is the subject of the claim.

This limit also applies to IBM's suppliers and your reseller. It is the maximum for which IBM, its suppliers, and your reseller are collectively responsible.

**UNDER NO CIRCUMSTANCES IS IBM LIABLE FOR ANY OF THE FOLLOWING: 1) THIRD-PARTY CLAIMS AGAINST YOU FOR DAMAGES (OTHER THAN THOSE UNDER THE FIRST ITEM LISTED ABOVE); 2) LOSS OF, OR DAMAGE TO, YOUR RECORDS OR DATA; OR 3) SPECIAL, INCIDENTAL, OR INDIRECT DAMAGES OR FOR ANY ECONOMIC CONSEQUENTIAL DAMAGES (INCLUDING LOST PROFITS OR SAVINGS), EVEN IF IBM, ITS SUPPLIERS OR YOUR RESELLER IS INFORMED OF THEIR POSSIBILITY. SOME JURISDICTIONS DO NOT ALLOW THE EXCLUSION OR LIMITATION OF INCIDENTAL OR CONSEQUENTIAL DAMAGES, SO THE ABOVE LIMITATION OR EXCLUSION MAY NOT APPLY TO YOU.**

## **Part 2 - Worldwide Country-Unique Terms**

---

### **ASIA PACIFIC**

**AUSTRALIA: The IBM Warranty for Machines:** The following paragraph is added to this Section:

The warranties specified in this Section are in addition to any rights you may have under the Trade Practices Act 1974 or other legislation and are only limited to the extent permitted by the applicable legislation.

**Extent of Warranty:** The following replaces the first and second sentences of this Section:

The warranty does not cover the repair or exchange of a Machine resulting from misuse, accident, modification, unsuitable physical or operating environment, operation in other than the Specified Operating Environment, improper maintenance by you, or failure caused by a product for which IBM is not responsible.

**Limitation of Liability:** The following is added to this Section:

Where IBM is in breach of a condition or warranty implied by the Trade Practices Act 1974, IBM's liability is limited to the repair or replacement of the goods or the supply of equivalent goods. Where that condition or warranty relates to right to sell, quiet possession or clear title, or the goods are of a kind ordinarily acquired for personal, domestic or household use or consumption, then none of the limitations in this paragraph apply.

**PEOPLE'S REPUBLIC OF CHINA: Governing Law:** The following is added to this Statement:

The laws of the State of New York govern this Statement.

**INDIA: Limitation of Liability:** The following replaces items 1 and 2 of this Section:

1. liability for bodily injury (including death) or damage to real property and tangible personal property will be limited to that caused by IBM's negligence;
2. as to any other actual damage arising in any situation involving nonperformance by IBM pursuant to, or in any way related to the subject of this Statement of Warranty, IBM's liability will be limited to the charge paid by you for the individual Machine that is the subject of the claim.

**NEW ZEALAND: The IBM Warranty for Machines:** The following paragraph is added to this Section:

The warranties specified in this Section are in addition to any rights you may have under the Consumer Guarantees Act 1993 or other legislation which cannot be excluded or limited. The Consumer Guarantees Act 1993 will not apply in respect of any goods which IBM provides, if you require the goods for the purposes of a business as defined in that Act.

**Limitation of Liability:** The following is added to this Section:

Where Machines are not acquired for the purposes of a business as defined in the Consumer Guarantees Act 1993, the limitations in this Section are subject to the limitations in that Act.

#### **EUROPE, MIDDLE EAST, AFRICA (EMEA)**

**The following terms apply to all EMEA countries.**

The terms of this Statement of Warranty apply to Machines purchased from an IBM reseller. If you purchased this Machine from IBM, the terms and conditions of the applicable IBM agreement prevail over this warranty statement.

#### **Warranty Service**

If you purchased an IBM Machine in Austria, Belgium, Denmark, Estonia, Finland, France, Germany, Greece, Iceland, Ireland, Italy, Latvia, Lithuania, Luxembourg, Netherlands, Norway, Portugal, Spain, Sweden, Switzerland or United Kingdom, you may obtain warranty service for that Machine in any of those countries from either (1) an IBM reseller approved to perform warranty service or (2) from IBM.

If you purchased an IBM Personal Computer Machine in Albania, Armenia, Belarus, Bosnia and Herzegovina, Bulgaria, Croatia, Czech Republic, Georgia, Hungary, Kazakhstan, Kirghizia, Federal Republic of Yugoslavia, Former Yugoslav Republic of Macedonia (FYROM), Moldova, Poland, Romania, Russia, Slovak Republic, Slovenia, or Ukraine, you may obtain warranty service for that Machine in any of those countries from either (1) an IBM reseller approved to perform warranty service or (2) from IBM.

The applicable laws, Country-unique terms and competent court for this Statement are those of the country in which the warranty service is being provided. However, the laws of Austria govern this Statement if the warranty service is provided in Albania, Armenia, Belarus, Bosnia and Herzegovina, Bulgaria, Croatia, Czech Republic, Federal Republic of Yugoslavia, Georgia, Hungary, Kazakhstan, Kirghizia, Former Yugoslav Republic of Macedonia (FYROM), Moldova, Poland, Romania, Russia, Slovak Republic, Slovenia, and Ukraine.



**The following terms apply to the country specified:**

**EGYPT: Limitation of Liability:** The following replaces item 2 in this Section:

2. as to any other actual direct damages, IBM's liability will be limited to the total amount you paid for the Machine that is the subject of the claim.

Applicability of suppliers and resellers (unchanged).

**FRANCE: Limitation of Liability:** The following replaces the second sentence of the first paragraph of this Section:

In such instances, regardless of the basis on which you are entitled to claim damages from IBM, IBM is liable for no more than: (items 1 and 2 unchanged).

**GERMANY: The IBM Warranty for Machines:** The following replaces the first sentence of the first paragraph of this Section:

The warranty for an IBM Machine covers the functionality of the Machine for its normal use and the Machine's conformity to its Specifications.

The following paragraphs are added to this Section:

The minimum warranty period for Machines is six months.

In case IBM or your reseller are unable to repair an IBM Machine, you can alternatively ask for a partial refund as far as justified by the reduced value of the unrepaired Machine or ask for a cancellation of the respective agreement for such Machine and get your money refunded.

**Extent of Warranty:** The second paragraph does not apply.

**Warranty Service:** The following is added to this Section:

During the warranty period, transportation for delivery of the failing Machine to IBM will be at IBM's expense.

**Production Status:** The following paragraph replaces this Section:

Each Machine is newly manufactured. It may incorporate in addition to new parts, re-used parts as well.

**Limitation of Liability:** The following is added to this Section:

The limitations and exclusions specified in the Statement of Warranty will not apply to damages caused by IBM with fraud or gross negligence and for express warranty.

In item 2, replace "U.S. \$100,000" with "1.000.000 DEM."

The following sentence is added to the end of the first paragraph of item 2:

IBM's liability under this item is limited to the violation of essential contractual terms in cases of ordinary negligence.

**IRELAND: Extent of Warranty:** The following is added to this Section:

Except as expressly provided in these terms and conditions, all statutory conditions, including all warranties implied, but without prejudice to the generality of the foregoing all warranties implied by the Sale of Goods Act 1893 or the Sale of Goods and Supply of Services Act 1980 are hereby excluded.

**Limitation of Liability:** The following replaces items one and two of the first paragraph of this Section:

1. death or personal injury or physical damage to your real property solely caused by IBM's negligence; and 2. the amount of any other actual direct damages, up to the greater of Irish Pounds 75,000 or 125 percent of the charges (if recurring, the 12 months' charges apply) for the Machine that is the subject of the claim or which otherwise gives rise to the claim.

Applicability of suppliers and resellers (unchanged).

The following paragraph is added at the end of this Section:

IBM's entire liability and your sole remedy, whether in contract or in tort, in respect of any default shall be limited to damages.

**ITALY: Limitation of Liability:** The following replaces the second sentence in the first paragraph:

In each such instance unless otherwise provided by mandatory law, IBM is liable for no more than: (item 1 unchanged) 2) as to any other actual damage arising in all situations involving non-performance by IBM pursuant to, or in any way related to the subject matter of this Statement of Warranty, IBM's liability, will be limited to the total amount you paid for the Machine that is the subject of the claim.

Applicability of suppliers and resellers (unchanged).

The following replaces the second paragraph of this Section:

Unless otherwise provided by mandatory law, IBM and your reseller are not liable for any of the following: (items 1 and 2 unchanged) 3) indirect damages, even if IBM or your reseller is informed of their possibility.

**SOUTH AFRICA, NAMIBIA, BOTSWANA, LESOTHO AND SWAZILAND: Limitation of Liability:** The following is added to this Section:

IBM's entire liability to you for actual damages arising in all situations involving nonperformance by IBM in respect of the subject matter of this Statement of Warranty will be limited to the charge paid by you for the individual Machine that is the subject of your claim from IBM.

**TURKIYE: Production Status:** The following replaces this Section:

IBM fulfils customer orders for IBM Machines as newly manufactured in accordance with IBM's production standards.

**UNITED KINGDOM: Limitation of Liability:** The following replaces items 1 and 2 of the first paragraph of this Section:

1. death or personal injury or physical damage to your real property solely caused by IBM's negligence;
2. the amount of any other actual direct damages or loss, up to the greater of Pounds Sterling 150,000 or 125 percent of the charges (if recurring, the 12 months' charges apply) for the Machine that is the subject of the claim or which otherwise gives rise to the claim.

The following item is added to this paragraph:

3. breach of IBM's obligations implied by Section 12 of the Sale of Goods Act 1979 or Section 2 of the Supply of Goods and Services Act 1982.

Applicability of suppliers and resellers (unchanged).

The following is added to the end of this Section:

IBM's entire liability and your sole remedy, whether in contract or in tort, in respect of any default will be limited to damages.

## **NORTH AMERICA**

**CANADA: Warranty Service:** The following is added to this Section:

To obtain warranty service from IBM, call **1-800-565-3344**.

**UNITED STATES OF AMERICA: Warranty Service:** The following is added to this Section:

To obtain warranty service from IBM, call **1-800-772-2227**.

---

## Notices

References in this publication to IBM products, programs, or services do not imply that IBM intends to make these available in all countries in which IBM operates. Any reference to an IBM product, program, or service is not intended to state or imply that only that IBM product, program, or service may be used. Subject to IBM's valid intellectual property or other legally protectable rights, any functionally equivalent product, program, or service may be used instead of the IBM product, program, or service. The evaluation and verification of operation in conjunction with other products, except those expressly designated by IBM, are the responsibility of the user.

IBM may have patents or pending patent applications covering subject matter in this document. The furnishing of this document does not give you any license to these patents. You can send license inquiries, in writing, to:

IBM Director of Licensing  
IBM Corporation  
North Castle Drive  
Armonk, NY 10504-1785  
U.S.A.

---

## Trademarks

The following terms are trademarks of the IBM Corporation in the United States or other countries or both:

HelpCenter                      IBM                                      Netfinity

Microsoft, Windows, and Windows NT are trademarks or registered trademarks of Microsoft Corporation in the United States, other countries, or both.

Other company, product, and service names may be trademarks or service marks of others.

---

## Electronic emission notices

40/80 GB DLT Internal Tape Drive

### Federal Communications Commission (FCC) Statement

**Note:** This equipment has been tested and found to comply with the limits for a Class B digital device, pursuant to Part 15 of the FCC Rules. These limits are designed to provide reasonable protection against harmful interference in a residential installation. This equipment generates, uses, and can radiate radio frequency energy and, if not installed and used in accordance with the instructions, may cause harmful interference to radio communications. However, there is no guarantee that interference will not occur in a particular installation. If this equipment does cause harmful interference to radio or television reception, which can be determined by turning the equipment off and on, the user is encouraged to try to correct the interference by one or more of the following measures:

- Reorient or relocate the receiving antenna.
- Increase the separation between the equipment and receiver.
- Connect the equipment into an outlet on a circuit different from that to which the receiver is connected.
- Consult an IBM authorized dealer or service representative for help.

Properly shielded and grounded cables and connectors must be used in order to meet FCC emission limits. Proper cables and connectors are available from IBM authorized dealers. IBM is not responsible for any radio or television interference caused by using other than recommended cables and connectors or by unauthorized changes or modifications to this equipment. Unauthorized changes or modifications could void the user's authority to operate the equipment.

This device complies with Part 15 of the FCC Rules. Operation is subject to the following two conditions: (1) this device may not cause harmful interference, and (2) this device must accept any interference received, including interference that may cause undesired operation.

Responsible Party:

International Business Machines Corporation  
New Orchard Road  
Armonk, NY 10504  
Telephone: 1-919-543-2193



Tested To Comply  
With FCC Standards

FOR HOME OR OFFICE USE

### Industry Canada Class B emission compliance statement

This Class B digital apparatus complies with Canadian ICES-003.

## **Avis de conformité à la réglementation d'Industrie Canada**

Cet appareil numérique de classe B est conforme à la norme NMB-003 du Canada.

## **Deutsche EMV-Direktive (electromagnetische Verträglichkeit)**

Dieses Gerät ist berechtigt in Übereinstimmung mit dem deutschen EMVG vom 9.Nov.92 das EG-Konformitätszeichen zu führen.

Der Aussteller der Konformitätserklärung ist die IBM UK, Greenock.

Dieses Gerät erfüllt die Bedingungen der EN 55022 Klasse B.

## **European Union - emission directive**

This product is in conformity with the protection requirements of EU Council Directive 89/366/ECC on the approximation of the laws of the Member States relating to electromagnetic compatibility.

IBM can not accept responsibility for any failure to satisfy the protection requirements resulting from a non-recommended modification of the product, including the fitting of non-IBM option cards.

This product has been tested and found to comply with the limits for Class B Information Technology Equipment according to CISPR 22 / European Standard EN 55022. The limits for Class B equipment were derived for typical residential environments to provide reasonable protection against interference with licensed communication devices.

## **Union Européenne - Directive Conformité électromagnétique**

Ce produit est conforme aux exigences de protection de la Directive 89/336/EEC du Conseil de l'UE sur le rapprochement des lois des États membres en matière de compatibilité électromagnétique.

IBM ne peut accepter aucune responsabilité pour le manquement aux exigences de protection résultant d'une modification non recommandée du produit, y compris l'installation de cartes autres que les cartes IBM.

Ce produit a été testé et il satisfait les conditions de l'équipement informatique de Classe B en vertu de CISPR22 / Standard européen EN 55022. Les conditions pour l'équipement de Classe B ont été définies en fonction d'un contexte résidentiel ordinaire afin de fournir une protection raisonnable contre l'interférence d'appareils de communication autorisés.

## **Unione Europea - Direttiva EMC (Conformità elettromagnetica)**

Este producto satisface los requisitos de protección del Consejo de la UE, Directiva 89/336/CEE en lo que a la legislatura de los Estados Miembros sobre compatibilidad electromagnética se refiere.

IBM no puede aceptar responsabilidad alguna si este producto deja de satisfacer dichos requisitos de protección como resultado de una modificación no recomendada del producto, incluyendo el ajuste de tarjetas de opción que no sean IBM.

Este producto ha sido probado y satisface los límites para Equipos Informáticos Clase B de conformidad con el Estándar CISPR22 y el Estándar Europeo EN 55022. Los límites para los equipos de Clase B se han establecido para entornos residenciales típicos a fin de proporcionar una protección razonable contra las interferencias con dispositivos de comunicación licenciados.

## **Unione Europea - Normativa EMC**

Questo prodotto è conforme alle normative di protezione ai sensi della Direttiva del Consiglio dell'Unione Europea 89/336/CEE sull'armonizzazione legislativa degli stati membri in materia di compatibilità elettromagnetica.

IBM non accetta responsabilità alcuna per la mancata conformità alle normative di protezione dovuta a modifiche non consigliate al prodotto, compresa l'installazione di schede e componenti di marca diversa da IBM.

Le prove effettuate sul presente prodotto hanno accertato che esso rientra nei limiti stabiliti per le apparecchiature di informatica Classe B ai sensi del CISPR 22 / Norma Europea EN 55022. I limiti delle apparecchiature della Classe B sono stati stabiliti al fine di fornire ragionevole protezione da interferenze mediante dispositivi di comunicazione in concessione in ambienti residenziali tipici.

この装置は、情報処理装置等電波障害自主規制協議会（VCCI）の基準に基づくクラスB情報技術装置です。この装置は、家庭環境で使用することを目的としていますが、この装置がラジオやテレビジョン受信機に近接して使用されると、受信障害を引き起こすことがあります。  
取扱説明書に従って正しい取り扱いをして下さい。





Part Number: P00N7816

Printed in U.S.A.

P00N7816

