



IBM C400 PROJECTOR

User's Guide



IBM C400 PROJECTOR

User's Guide

Bilješka: Before using this information and the product it supports, read the information in and Dodatak E, “IBM Statement of Limited Warranty Z125-4753-08 04/2004”, na stranici E-1.

Sadržaj

Safety information v

General safety guidelines vii

Service	vii
Power cords and power adapters	vii
Extension cords and related devices	vii
Plugs and outlets	viii
Batteries	viii
Heat and product ventilation	viii
CD and DVD drive safety.	ix

Registering your option. xi

Poglavlje 1. Opis proizvoda 1-1

Kontrola lista za pakiranje	1-1
Svojstva projektor	1-3

Poglavlje 2. Postavljanje projektor 2-1

Pokretanje projektor	2-1
Isključivanje projektor	2-1
Pozicioniranje projektor	2-2
Podešavanje razine i visine projektor	2-4
Podešavanje slike	2-4
Podešavanje glasnoće	2-5

Poglavlje 3. Povezivanje uređaja na projektor 3-1

Uređaji za povezivanje	3-1
Spajanje na USB uređaj	3-2
Spajanje na monitor računala	3-2

Poglavlje 4. Upotreba funkcija projektor 4-1

Prije nego započnete	4-1
Upotreba daljinskog upravljača.	4-2
Radni raspon	4-3
Projektor i gumbi na daljinskom upravljaču	4-3

Poglavlje 5. Kontrole izbornika Prikaza na ekranu 5-1

Kretanje po OSD-u	5-1
Jezik	5-1
Izbornik Kvaliteta	5-1
Izbornik Svojstva	5-3

Izbornik Opcije	5-4
Izbornik Postav	5-5
Izbornik Informacije	5-7
Izbornik Mrežne postavke	5-8

Poglavlje 6. Rad udaljene mreže. 6-1

Pregled udaljenog sučelja	6-1
Postavljanje udaljenih operacija	6-4
Korištenje DHCP adresnih postavki	6-5
Omogućavanje i onemogućavanje lozinke	6-6
Postavljanje najvećeg broja veza	6-7
Dohvaćanje zaboravljene lozinke	6-8

Dodatak A. Održavanje A-1

Čišćenje projektor	A-1
Čišćenje leće	A-1
Čišćenje kućišta	A-1
Zamjena lampe u projektoru	A-1
Resetiranje timera lampe	A-3
Upotreba sigurnosnog proreza	A-3

Dodatak B. Rješavanje problema B-1

Zajednički problemi i rješenja	B-1
Savjeti za rješavanje problema	B-1
Informacije za rješavanje problema	B-1
Projektor LED-ovi	B-3

Dodatak C. Specifikacije C-1

Dodatak D. Service and Support D-1

Online technical support	D-1
Telephone technical support	D-1

Dodatak E. IBM Statement of Limited Warranty Z125-4753-08 04/2004 E-1

Part 1 - General Terms	E-1
Part 2 - Country-unique Terms	E-3
Part 3 - Warranty Information.	E-13
Types of Warranty Service	E-13

Dodatak F. Notices F-1

Trademarks	F-2
Electronic emission notices	F-2
Federal Communications Commission (FCC) statement	F-2

Safety information

Before installing this product, read the Safety Information.

مج، يجب قراءة دات السلامة

Antes de instalar este produto, leia as Informações de Segurança.

在安装本产品之前，请仔细阅读 **Safety Information** (安全信息)。

Prije instalacije ovog produkta obavezno pročitajte Sigurnosne Upute.

Před instalací tohoto produktu si přečtěte příručku bezpečnostních instrukcí.

Læs sikkerhedsforskrifterne, før du installerer dette produkt.

Ennen kuin asennat tämän tuotteen, lue turvaohjeet kohdasta Safety Information.

Avant d'installer ce produit, lisez les consignes de sécurité.

Vor der Installation dieses Produkts die Sicherheitshinweise lesen.

Πριν εγκαταστήσετε το προϊόν αυτό, διαβάστε τις πληροφορίες ασφάλειας (safety information).

לפני שתתקינו מוצר זה, קראו את הוראות הבטיחות.

A termék telepítése előtt olvassa el a Biztonsági előírásokat!

Prima di installare questo prodotto, leggere le Informazioni sulla Sicurezza.

製品の設置の前に、安全情報をお読みください。

본 제품을 설치하기 전에 안전 정보를 읽으십시오.

Пред да се инсталира овој продукт, прочитајте информацијата за безбедност.

Lees voordat u dit product installeert eerst de veiligheidsvoorschriften.

Les sikkerhetsinformasjonen (Safety Information) før du installerer dette produktet.

Przed zainstalowaniem tego produktu, należy zapoznać się z książką "Informacje dotyczące bezpieczeństwa" (Safety Information).

Antes de instalar este produto, leia as Informações sobre Segurança.

Перед установкой продукта прочтите инструкции по технике безопасности.

Pred inštaláciou tohto produktu si prečítajte bezpečnostné informácie.

Pred namestitvijo tega proizvoda preberite Varnostne informacije.

Antes de instalar este producto lea la información de seguridad.

Läs säkerhetsinformationen innan du installerar den här produkten.

安裝本產品之前，請先閱讀「安全資訊」。

General safety guidelines

Always observe the following precautions to reduce the risk of injury and property damage.

Service

Do not attempt to service a product yourself unless instructed to do so by the IBM Support Center. Use only an IBM authorized service provider who is approved to repair your particular product.

Note: Some parts can be upgraded or replaced by the customer. These parts are referred to as Customer Replaceable Units, or CRUs. IBM expressly identifies CRUs as such, and provides documentation with instructions when it is appropriate for customers to replace those parts. You must closely follow all instructions when performing such replacements. Always make sure that the power is turned off and that the product is unplugged from any power source before you attempt the replacement. If you have any questions or concerns, contact the IBM Support Center.

Power cords and power adapters

Use only the power cords and power adapters supplied by the product manufacturer.

Never wrap a power cord around the power adapter or other object. Doing so can stress the cord in ways that can cause the cord to fray, crack or crimp. This can present a safety hazard.

Always route power cords so that they will not be walked on, tripped over, or pinched by objects.

Protect the cord and power adapters from liquids. For instance, do not leave your cord or power adapter near sinks, tubs, toilets, or on floors that are cleaned with liquid cleansers. Liquids can cause a short circuit, particularly if the cord or power adapter has been stressed by misuse. Liquids can also cause gradual corrosion of the power cord terminals and/or the connector terminals on the adapter which can eventually result in overheating.

Always connect power cords and signal cables in the correct order and ensure that all power cord connectors are securely and completely plugged into receptacles.

Do not use any power adapter that shows corrosion at the ac input pins and/or shows signs of overheating (such as deformed plastic) at the ac input or anywhere on the power adapter.

Do not use any power cords where the electrical contacts on either end show signs of corrosion or overheating or where the power cord appears to have been damaged in any way.

Extension cords and related devices

Ensure that extension cords, surge protectors, uninterruptible power supplies, and power strips that you use are rated to handle the electrical requirements of the product. Never overload these devices. If power strips are used, the load should not exceed the power strip input rating. Consult an electrician for more information if you have questions about power loads, power requirements, and input ratings.

Plugs and outlets

If a receptacle (power outlet) that you intend to use with your computer equipment appears to be damaged or corroded, do not use the outlet until it is replaced by a qualified electrician.

Do not bend or modify the plug. If the plug is damaged, contact the manufacturer to obtain a replacement.

Some products are equipped with a three-pronged plug. This plug fits only into a grounded electrical outlet. This is a safety feature. Do not defeat this safety feature by trying to insert it into a non-grounded outlet. If you cannot insert the plug into the outlet, contact an electrician for an approved outlet adapter or to replace the outlet with one that enables this safety feature. Never overload an electrical outlet. The overall system load should not exceed 80 percent of the branch circuit rating. Consult an electrician for more information if you have questions about power loads and branch circuit ratings.

Be sure that the power outlet you are using is properly wired, easily accessible, and located close to the equipment. Do not fully extend power cords in a way that will stress the cords.

Connect and disconnect the equipment from the electrical outlet carefully

Batteries

All IBM personal computers contain a non-rechargeable coin cell battery to provide power to the system clock. In addition many mobile products such as Thinkpad notebook PCs utilize a rechargeable battery pack to provide system power when in portable mode. Batteries supplied by IBM for use with your product have been tested for compatibility and should only be replaced with IBM approved parts.

Never attempt to open or service any battery. Do not crush, puncture, or incinerate batteries or short circuit the metal contacts. Do not expose the battery to water or other liquids. Only recharge the battery pack strictly according to instructions included in the product documentation.

Battery abuse or mishandling can cause the battery to overheat, which can cause gasses or flame to “vent” from the battery pack or coin cell. If your battery is damaged, or if you notice any discharge from your battery or the buildup of foreign materials on the battery leads, stop using the battery and obtain a replacement from the battery manufacturer.

Batteries can degrade when they are left unused for long periods of time. For some rechargeable batteries (particularly Lithium Ion batteries), leaving a battery unused in a discharged state could increase the risk of a battery short circuit, which could shorten the life of the battery and can also pose a safety hazard. Do not let rechargeable Lithium-Ion batteries completely discharge or store these batteries in a discharged state.

Heat and product ventilation

Computers generate heat when turned on and when batteries are charging. Notebook PCs can generate a significant amount of heat due to their compact size. Always follow these basic precautions:

- Do not leave the base of your computer in contact with your lap or any part of your body for an extended period when the computer is functioning or when the battery is charging. Your computer produces some heat during normal operation. Extended contact with the body could cause discomfort or, potentially, a skin burn.

- Do not operate your computer or charge the battery near flammable materials or in explosive environments.
- Ventilation slots, fans and/or heat sinks are provided with the product for safety, comfort, and reliable operation. These features might inadvertently become blocked by placing the product on a bed, sofa, carpet, or other flexible surface. Never block, cover or disable these features.

CD and DVD drive safety

CD and DVD drives spin discs at a high speed. If a CD or DVD is cracked or otherwise physically damaged, it is possible for the disc to break apart or even shatter when the CD drive is in use. To protect against possible injury due to this situation, and to reduce the risk of damage to your machine, do the following:

- Always store CD/DVD discs in their original packaging
- Always store CD/DVD discs out of direct sunlight and away from direct heat sources
- Remove CD/DVD discs from the computer when not in use
- Do not bend or flex CD/DVD discs, or force them into the computer or their packaging
- Check CD/DVD discs for cracks before each use. Do not use cracked or damaged discs

Registering your option

Thank you for purchasing this IBM® product. Please take a few moments to register your product and provide us with information that will help IBM to better serve you in the future. Your feedback is valuable to us in developing products and services that are important to you, as well as in developing better ways to communicate with you. Register your option on the IBM Web site at

<http://www.ibm.com/pc/register/>

IBM will send you information and updates on your registered product unless you indicate on the Web site questionnaire that you do not want to receive further information.

Poglavlje 1. Opis proizvoda

IBM C400 PROJECTOR projicira čistu, kvalitetnu sliku koja vam omogućuje profesionalne prezentacije. Mala težina i kompaktna veličina čine C400 pravim rješenjem koje dopušta jednostavno premještanje iz ureda u sobu za sastanke, ili na lokaciju korisnika. Neka od glavnih svojstava ovog projektora su:

- Ekstremna snaga, mala težina, te prenosivost na 3.1 kg (6.8 lbs).
- Oštre i čiste slike sa visokim omjerom kontrasta 1200:1
- Upravljanje imovinom: Provjerite udaljeno stanje vašeg C400 PROJECTOR putem Web pretražitelja (zaštita lozinkom), preko RJ-45 veze (život lampe i tehničko stanje), ili postavite da projektor generira i pošalje e-poštu administratoru.
- Divna reprodukcija visoko kvalitetnih slika sa vašeg PC-a i ostalih uređaja (npr. DVD playera).

Kontrola lista za pakiranje

U dodatku ovom vodiču za korisnike, vaš paket sadrži i sljedeće:

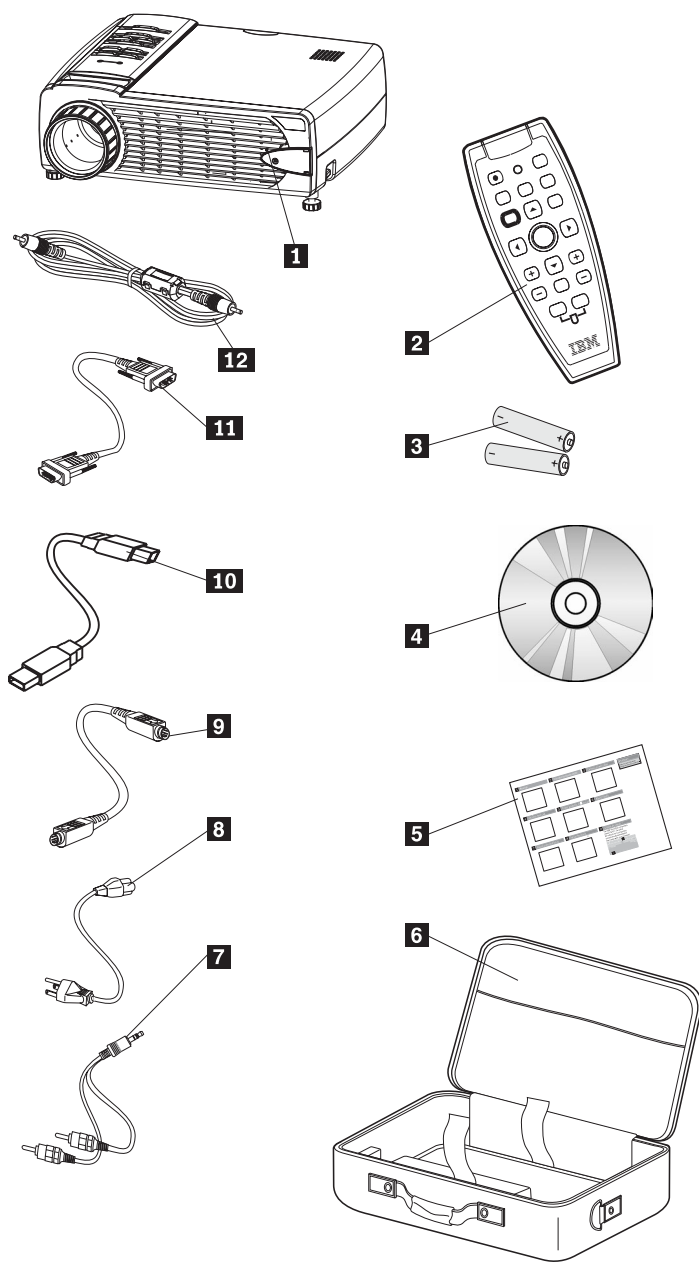

Slika 1-1. Standardni pribor

- 1** Projektor
- 2** Daljinski upravljač
- 3** Baterije
- 4** Korisnički vodič (i instalacijski) CD
- 5** Višejezični vodič za brz početak
- 6** Torbica za prijenos
- 7** Audio kabel (Mini utikač- RCA)
- 8** Naponska žica
- 9** Video kabel (S-video)
- 10** USB kabel (USB-Mini USB)

- 11** Računalni kabel (DVI-I)
- 12** Video kabel (RCA- RCA)

Ako bilo koji dio nedostaje ili je oštećen, molimo obratite se vašem mjestu kupnje.

Bilješka: Sačuvajte dokaz o kupnji; bit će vam potreban da dobijete jamstveni servis.

Za dodatne informacije o projektoru, pogledajte <http://www.ibm.com>.

Važno:

- Izbjegavajte upotrebu projektoru u prašnjavao okolini
- Ostavite naponski kabel prikopčan (2-5 minuta) dok se projektor ne vrati na sobnu temperaturu, prije nego što ga stavite u torbu za nošenje. Ako stavljate projektor u torbu prerano, nakon isključivanja napajanja, može doći do pregrijavanja projektoru i to će skratiti trajanje lampe.
- Svakako stavite poklopac na leću i stavljajte projektor u meku torbu s lećom prema gore da se izbjegne oštećenje leće.

Svojstva projektoru

Slike prikazuju različite poglede i svojstva projektoru.

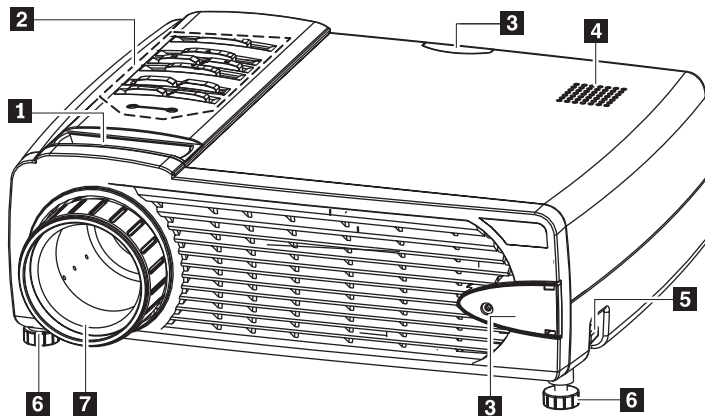

Slika 1-2. Pogled na prednji dio projektoru

- 1** Zum
- 2** Gumbi Prikaza na ekranu (OSD) i Diode emitiranja svjetlosti (LEDs)
- 3** Primalac za daljinski upravljač (IR)
- 4** Zvučnik
- 5** Gumb za podešavanje noge podizača
- 6** Noga podizača
- 7** Prsten fokusa

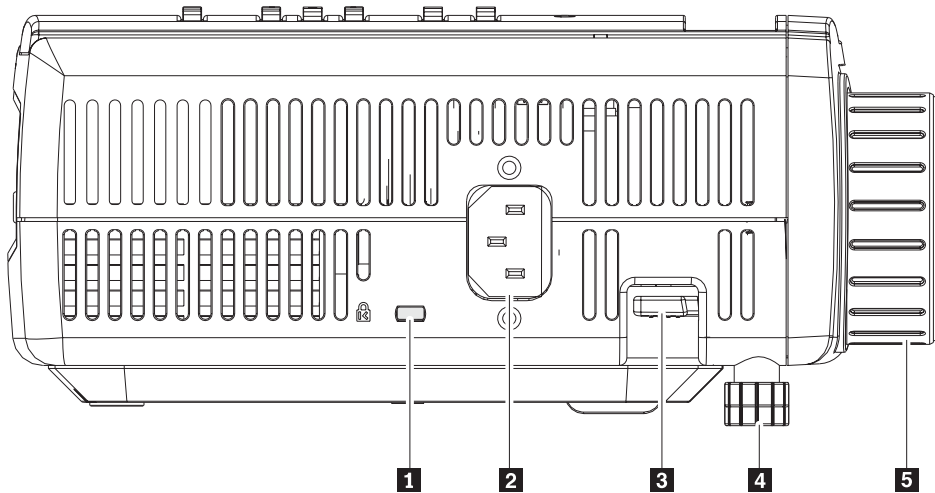

Slika 1-3. Pogled na projektor sa strane

- 1** Priključak za sigurnosno zaključavanje
- 2** Utičnica za AC napajanje
- 3** Gumb za podešavanje noge podizača
- 4** Noga podizača
- 5** Prsten fokusa

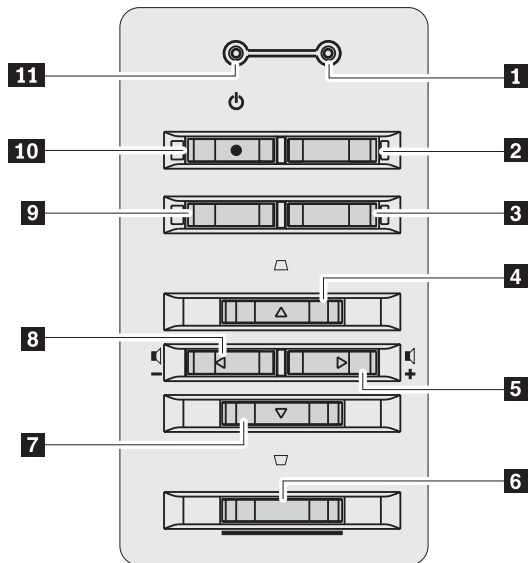

Slika 1-4. OSD gumbi i LEDs

- 1** LED spremnosti
- 2** Gumb izvora
- 3** Gumb Enter
- 4** Keystone/gore gumb kursora
- 5** Jačina zvuka/desno gumb kursora
- 6** Gumb izbornika

- 7** Keystone/dolje gumb kursora
- 8** Jačina zvuka/lijevo gumb kursora
- 9** Gumb Auto
- 10** Gumb za uključivanje
- 11** LED uključivanja

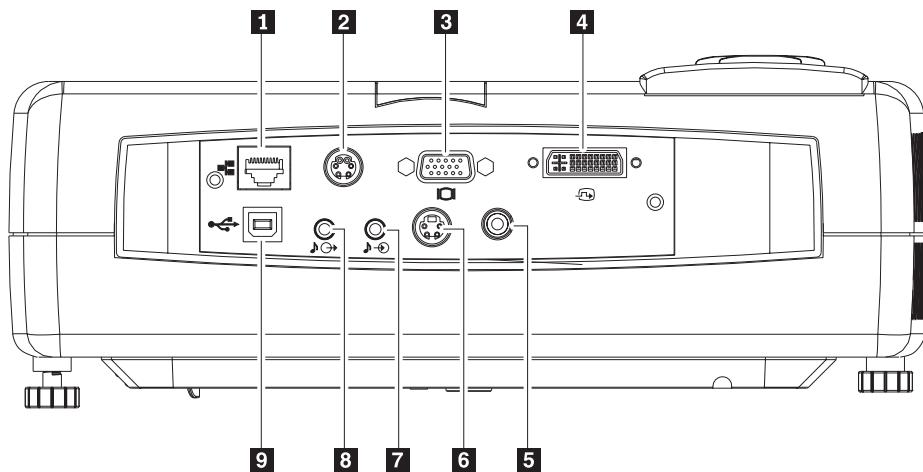

Slika 1-5. Pogled na stražnji dio projektora

- 1** Mreža lokalnog područja RJ-45
- 2** RS-232
- Bilješka:** Ovo je servisni port i nije namijenjen za osobnu uporabu.
- 3** Izlaz za monitor
- 4** DVI-I
- 5** Sastavljeni video
- 6** S-video
- Bilješka:** Ukoliko vaša oprema sadrži utičnice za S-video i RCA (kompozitni video), spojite na S-video konektor za optimalnu kvalitetu signala.
- 7** Audio-in
- 8** Audio-out
- 9** USB

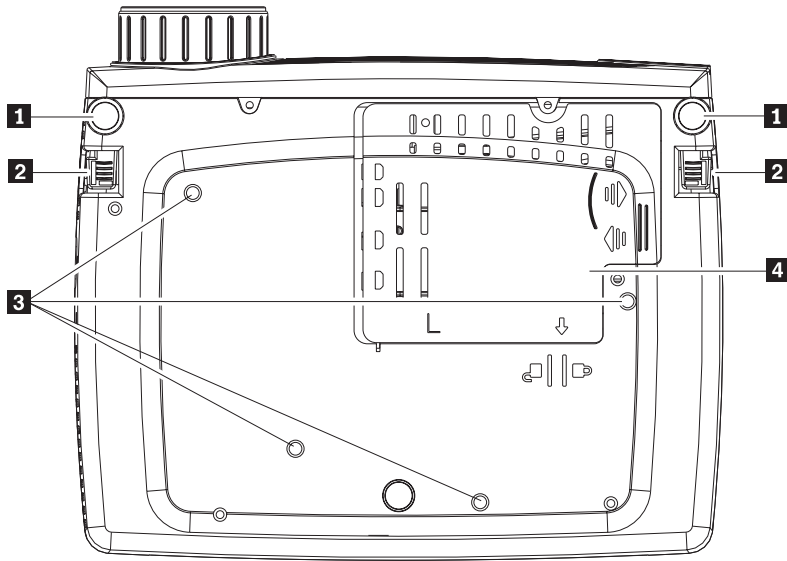

Slika 1-6. Pogled na dno projektora

- 1** Prednja noga podizača
- 2** Gumbi za podešavanje noge podizača
- 3** Rupe za montažu
- 4** Poklopac za lampu projektora

Poglavlje 2. Postavljanje projektor

Ovo poglavlje sadrži informacije o položaju projektor, spajanju računala i prikazivanju i podešavanju slike.

Pokretanje projektor

Da pokrenete projektor, učinite slijedeće:

1. Spojite naponsku žicu na projektor kako je pokazano dolje. Spojite drugi kraj utikača u električnu utičnicu. Uključuju se LED za uključenje i spremnost lampe.

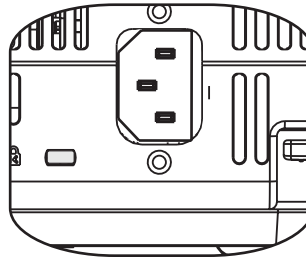

2. Uklonite poklopac leće.
3. Spojite ulazne uređaje.
4. Uključite spojene ulazne uređaje.
5. Osigurajte da zeleno svijetli LED za uključenje (ne smije treperiti) i pritisnite gumb **Uključenje** za uključenje projektor.

Otvora se prozor prikaza projektor i projektor otkriva pripojene uređaje. Ukoliko ste spojili projektor na IBM računalo, pritisnite Fn+F7 na računalo kako bi mijenjali izlaz prikaza na projektoru. Ukoliko ste spojili projektor na računalo koje nije IBM, pogledajte dokumentaciju koja je došla sa računalom za informacije o promjeni izlaza prikaza.

Upozorenje: Ne gledajte izravno u leću projektor kad je lampa uključena. Jako svjetlo može štetiti vašim očima.

6. Ukoliko ste spojili više od jednog ulaznog uređaja na projektor, pomoću gumba **Izvor** mijenjate uređaje. (DVD i HDTV podržani su kroz DVI-I konektor kabla.)
7. Za informacije o isključivanju projektor, idite na "Isključivanje projektor".

Upozorenje: Prije premještanja projektor, normalno isključite projektor i odspojite ga od izvora napajanja. Pogledajte "Isključivanje projektor" za više informacija o normalnom isključivanju projektor.

Isključivanje projektor

Da isključite projektor, učinite slijedeće:

1. Pritisnite gumb **Uključi**.

Projektor se priprema za isključenje i prikazuje se poruka **Pričekajte trenutak**, kako je prikazano. Projektor se automatski isključuje za 5 sekundi.

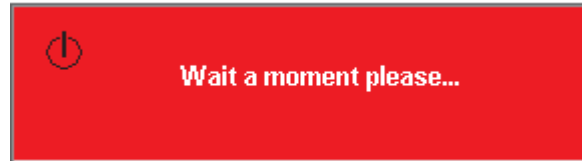

Bilješka: Ova operacija se može opozvati pritiskom na neki drugi gumb koji nije gumb **Uključi**. Ponovno pritiskanje gumba **Uključi** isključiti će projektor.

Bilješka: Ostavite naponski kabel prikopčan barem 2-5 minuta dok se projektor ne vrati na sobnu temperaturu, prije nego što ga stavite u torbu za nošenje. Smještaj projektoru u torbu ubrzo nakon isključenja može imati za posljedicu pregrijavanje projektoru.

2. Pritisnite gumb **Uključi** kada se ponovno pojavi poruka **Isključi?**/Pritisni ponovno **Uključi**, kako je prikazano.



Projektor se isključuje.

Pozicioniranje projektoru

Za određivanje položaja projektoru, uzmite u obzir veličinu i oblik ekrana, lokaciju utičnice i razmak između projektoru i ostatka opreme. Neka općenita uputstva:

- Postavite projektor na ravnu površinu pod pravim kutem u odnosu na ekran. Projektor mora biti najmanje 1.5 m (4.9 ft) od ekrana za projekciju.
- Postavite projektor unutar 2.7 m (9 ft) od izvora električne energije i unutar 1.8 m (6 ft) vašeg video uređaja (osim ako niste kupili produžni kabel). Da bi osigurali prikladan pristup kablom, ne postavljajte projektor unutar .15 m (6 in.) pored zida ili ostalih objekata.
- Postavite projektor na željenu udaljenost od ekrana. Udaljenost od leća projektoru do ekrana, postavke zuma i video format određuju veličinu projicirane slike.

Upozorenje: Provjerite dovoljan tok zraka projektoru i uklonite prepreke cirkulaciji zraka. Također, osigurajte da projektor nije u ograničenom prostoru.

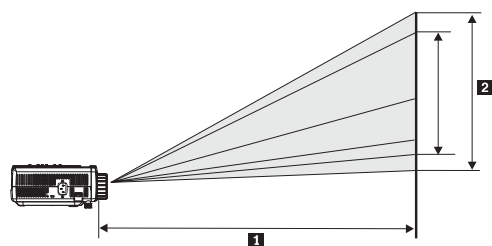

Slika 2-1. Visina slike

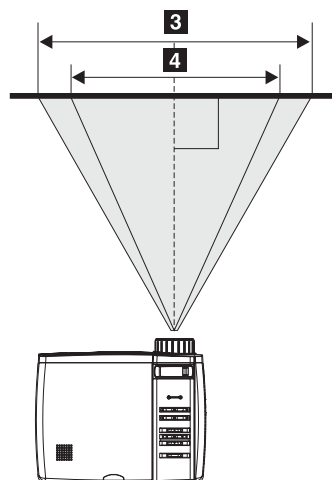

Slika 2-2. Širina slike

Tablica 2-1.

Udaljenost projekcije 1 (m/ft)	Širina slike 2 (m/in.)	Dijagonalna veličina slike 3 (m/in.)	Visina slike 4 (m/in.)
1.5 m/4.92 ft	1.1 m/42.5 in.	0.9 m/33.8 in.	0.7 m/25.6 in.
2.0 m/6.56 ft	1.4 m/56.7 in.	1.2 m/45.3 in.	0.9 m/34.0 in.
2.4 m/7.87 ft	1.7 m/67.7 in.	1.4 m/53.9 in.	1.0 m/40.5 in.
2.8 m/9.18 ft	2.0 m/79.1 in.	1.6 m/62.9 in.	1.2 m/47.4 in.
3.2 m/10.5 ft	2.3 m/90.5 in.	1.8 m/72.4 in.	1.4 m/54.3 in.
3.6 m/11.81 ft	2.6 m/101.9 in.	2.1 m/81.5 in.	1.5 m/61.0 in.
4.0 m/13.12 ft	2.9 m/113.4 in.	2.3 m/90.6 in.	1.7 m/68.1 in.
4.4 m/14.43 ft	3.2 m/124.8 in.	2.5 m/99.6 in.	1.9 m/74.8 in.
4.8 m/15.74 ft	3.5 m/135.8 in.	2.8 m/108.7 in.	2.1 m/81.6 in.
5.2 m/17.06 ft	3.7 m/147.2 in.	3.0 m/117.7 in.	2.2 m/88.2 in.
5.6 m/18.37 ft	4.0 m/158.7 in.	3.2 m/126.8 in.	2.4 m/95.3 in.
5.0 m/19.68 ft	4.3 m/170.1 in.	3.5 m/135.8 in.	2.6 m/101.9 in.
10.0 m/32.8 ft	7.2 m/283.5 in.	5.8 m/226.8 in.	4.3 m/170.1 in.

Podešavanje razine i visine projektor

Da podesite razinu i visinu projektor, izvedite sljedeći postupak:

1. Da povećate visinu projektor, podignite ga **1** i pritisnite gubme za podešavanje visine **2**. Ispasti će stalak za podizanje **3**.
2. Za manja podešanja visine, zakrenite podizač **4** kako je prikazano.
3. Da smanjite visinu projektor, pritisnite gumb za podešavanje visine i pritisnite vrh projektor prema dolje.

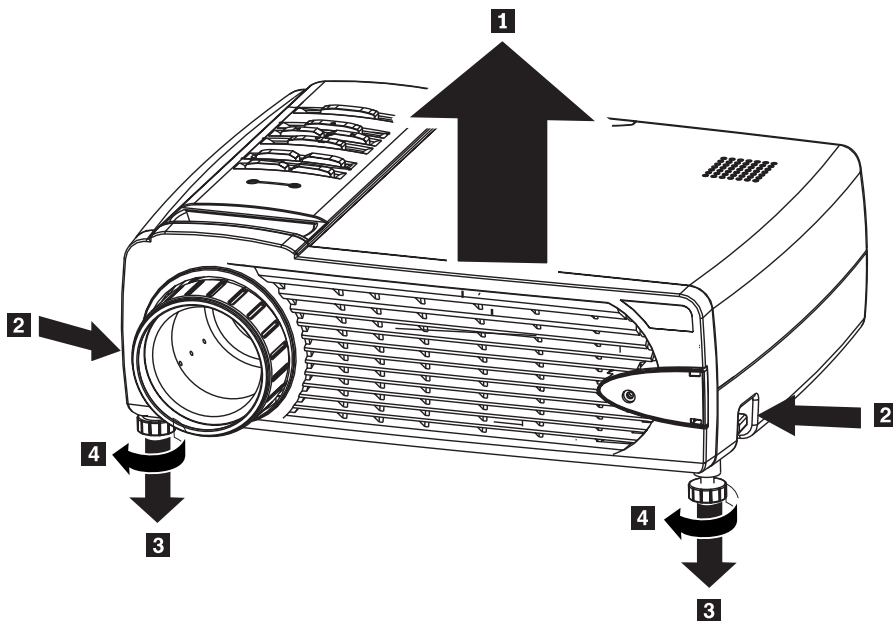

Bilješka:

- Stol ili stalak za projektor trebaju biti čvrsti i ravni.
- Postavite projektor okomito na ekran.
- Provjerite da kablovi *nisu* u položaju da mogu pasti preko projektor.

Podešavanje slike

Da podesite zum, fokus i keystone slike, učinite slijedeće:

1. Zakrenite prstene projektoru da podesite fokus **1** i zum **2**, kako je prikazano.

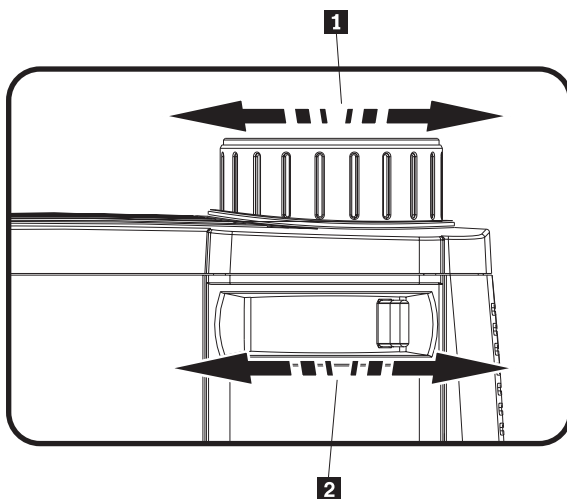

2. Koristite gumb**Keystone** na projektoru ili daljinski za ispravak efekta trapeza slike (širi vrh ili dno). Keystone gumbi na daljinskom i projektoru prikazani su niže.

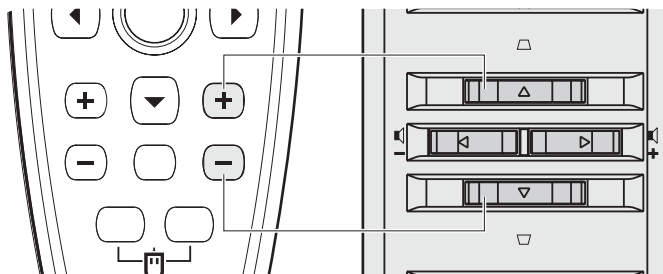

Kontrola keystone pojavljuje se na Ekranskom prikazu (OSD), kako je prikazano.



Podešavanje glasnoće

Da podesite glasnoću, učinite slijedeće:

1. Pritisnite gumb**Glasnoća +/-** na projektoru ili daljinskom upravljaču. Na OSD-u se pojavljuje kontrola glasnoće.



2. Koristite gumb**Glasnoća +/-** kako je prikazano, da bi podesili razinu.

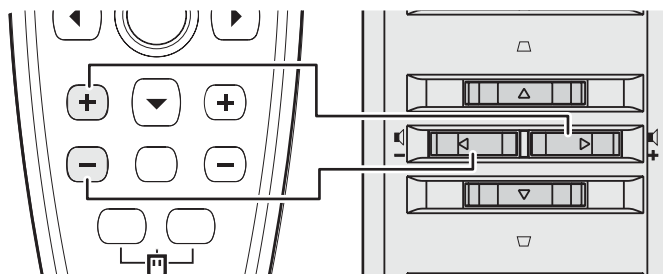

3. Pritisnite gumb **Mute** (samo na daljinskom upravljaču) da isključite glas.
4. Pritisnite bilo koje gumb **Glasnoća +/-** na projektoru ili daljinskom upravljaču da isključite prigušenje tona.

Poglavlje 3. Povezivanje uređaja na projektor

Ovo poglavlje pruža informacije o spajanju uređaja na C400 projektor.

Uređaji za povezivanje

Računala i video uređaji se mogu povezati na projektor u isto vrijeme. Pogledajte dokumentaciju koja je došla sa uređajem za povezivanje kako bi provjerili da uređaj sadrži prikladan izlazni konektor.

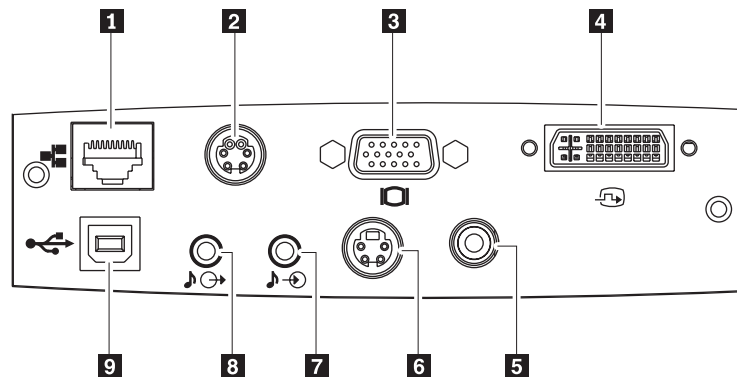

1 Mreža lokalnog područja RJ-45

2 RS-232

Bilješka: Ovo je servisni port i nije namijenjen za osobnu uporabu.

3 Izlaz za monitor

4 DVI-I

5 Sastavljeni video

6 S-video

Bilješka: Ukoliko vaša oprema sadrži utičnice za S-video i RCA (kompozitni video), spojite na S-video konektor za optimalnu kvalitetu signala.

7 Audio-in

8 Audio-out

9 USB

Spajanje na USB uređaj

Da bi kontrolirali vašeg računalnog miša koristeći daljinski upravljač projektor, spojite projektor na računalo sa USB kablom, kako je prikazano.

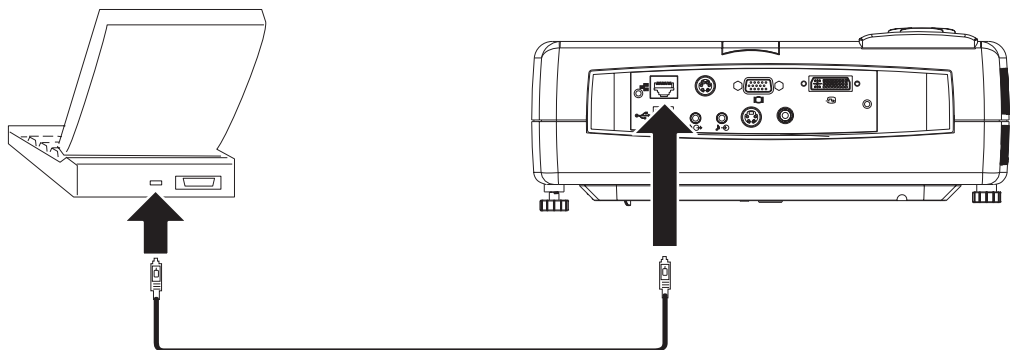

Bilješka: Funkcioniranje USB miša podržano je jedino sa Windows 2000 i Windows XP.

Spajanje na monitor računala

Ukoliko koristite stolno računalo i želite vidjeti sliku na ekranu vašeg računala, ali na projekcijskom ekranu, uključite kabel monitora na konektor Izlaz monitora na projektoru.

Poglavlje 4. Upotreba funkcija projektor

Ovo poglavlje sadrži informacije o instaliranju baterija daljinskog upravljača i korištenju daljinskog upravljača, audia, gumbi ekranske tipkovnice, i ostalih svojstva projektor.

Prije nego započnete

Prije nego počnete koristiti daljinski upravljač, morate instalirati AAA baterije koje su došle sa projektorom. Da instalirate baterije, učinite slijedeće:

Bilješka:

- Koristite jedino AAA alkalne baterije.
 - Odbacite iskorištene baterije u skladu s lokalnim odredbama i pravilima.
 - Uklonite baterije kada ne koristite daljinski upravljač duže razdoblje.
1. Uklonite poklopac baterije sa daljinskog upravljača kako je prikazano.

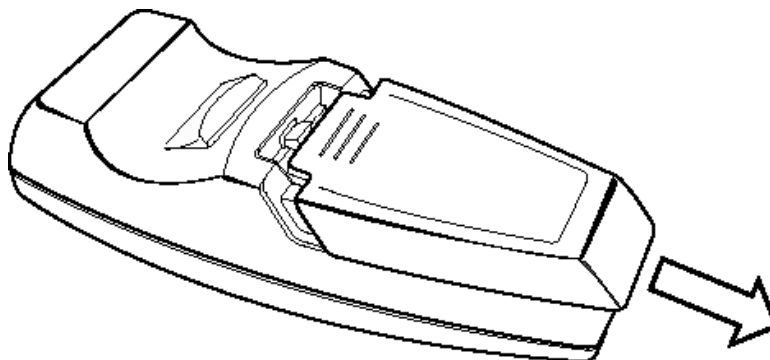

2. Umetnite dobavljene baterije u spremnik za baterije daljinskog upravljača, poravnavajući polaritet (+/-) baterija sa ikonama polariteta u spremniku, kako je prikazano.

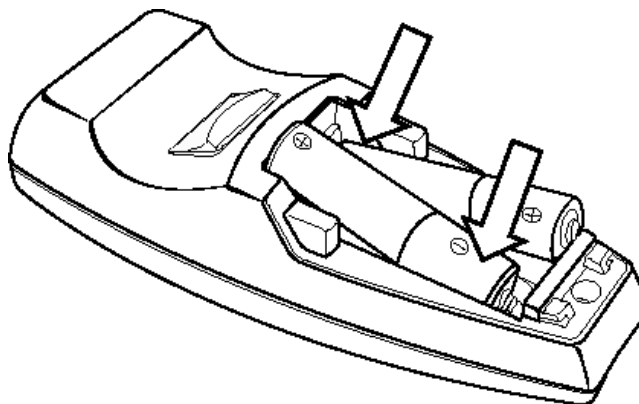

3. Namjestite poklopac, kako je pokazano.

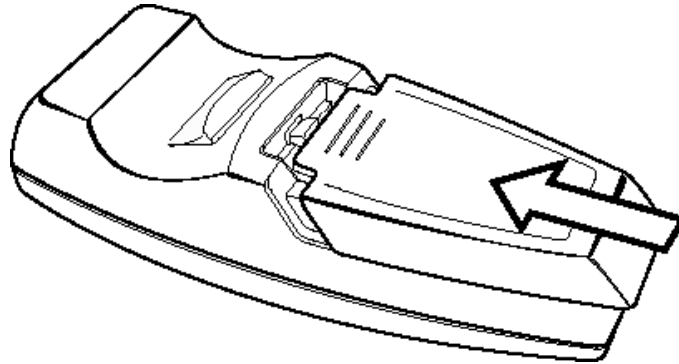

Upotreba daljinskog upravljača

Donja slika prikazuje daljinski upravljač.



Pozor:

Radi smanjenja rizika od ozljede očiju, ne gledajte izravno u lasersko svjetlo daljinskog upravljača i ne usmjeravajte lasersko svjetlo u oči neke druge osobe. Daljinski upravljač je opremljen s laserom Klase II koji emitira zračenje.

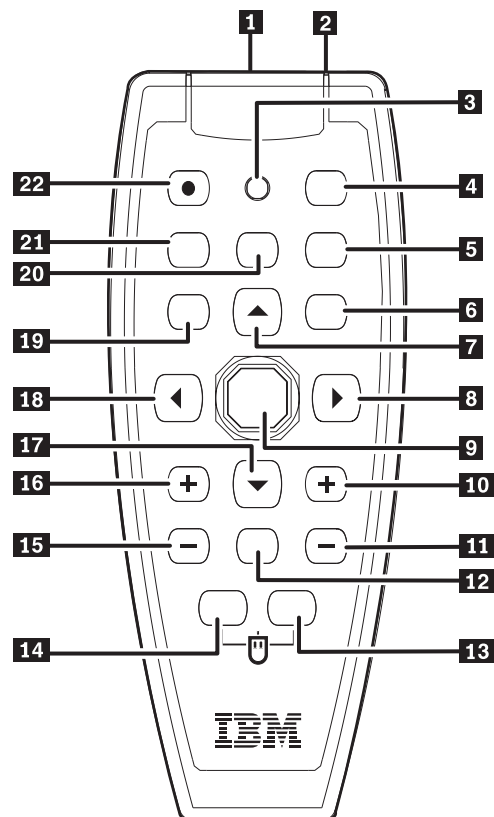

- 1 Laser
- 2 IR odašiljač
- 3 Status LED
- 4 Auto
- 5 Blank
- 6 Enter
- 7 Kursor gore
- 8 Kursor desno
- 9 Kursor podloga
- 10 Temeljni položaj vrh
- 11 Temeljni položaj dno
- 12 Mute
- 13 Miš desno
- 14 Miš lijevo
- 15 Volume dolje
- 16 Volume gore
- 17 Kursor dolje
- 18 Kursor lijevo
- 19 Izbornik
- 20 Zamrzni
- 21 Izvor
- 22 Uključi

Radni raspon

Ovaj daljinski upravljač koristi infracrveni prijenos za kontrolu projektor. Nije potrebno da daljinski uvijek usmjerite izravno na projektor. Daljinski upravljač raditi će unutar maksimalnog radijusa od 10m (32.8 ft) i 30° iznad ili ispod razine projektor. Ukoliko projektor ne odgovori na daljinsku naredbu, pogledajte Dodatak B, "Rješavanje problema", na stranici B-1.

Bilješka: Daljinski upravljač će i dalje raditi kada bude usmjeren na projiciranu sliku.

Projektor i gumbi na daljinskom upravljaču

S projektorom se može upravljati s daljinskim upravljačem ili pomoću gumba na vrhu projektor. Sve operacije se mogu izvesti s daljinskim upravljačem. Donja slika pokazuje odgovarajuće gumbе na daljinskom upravljaču i na projektoru za rad s OSD izbornikom.

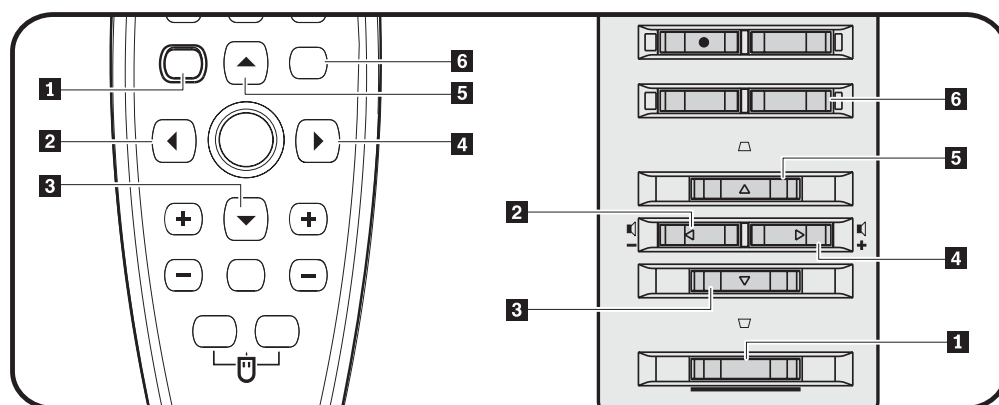

- 1** Izbornik
- 2** Gumb Lijevo
- 3** Gumb Dolje
- 4** Gumb Desno
- 5** Gumb Gore
- 6** Gumb Enter

Poglavlje 5. Kontrole izbornika Prikaza na ekranu

Ovaj projektor ima Prikaz na ekranu (OSD - On-Screen Display) koji vam omogućuje da radite podešavanja slike i promjene različitih postavki.

Bilješka: Morate imati prikaz na ekranu da bi mogli pristupiti OSD-u.

Kretanje po OSD-u

Za kretanje po OSD-u i izvođenje promjena na OSD-u možete koristiti daljinski upravljač ili gumb na vrhu projektor. Sljedeći odlomci pokazuju izbornike na OSD-u.

Jezik

Da postavite OSD jezik, učinite slijedeće:

Bilješka: Defaultni OSD jezik je engleski.

1. Pritisnite gumb **Izbornik**. Prikazuje se meni jezika.
2. Pritisnite gumbе kursora lijevo/desno dok se ne osvijetli Jezik.
3. Pritisnite gumbе kursora gore/dolje dok se ne osvijetli jezik kojeg želite.
4. Pritisnite **Enter** da odaberete jezik.
5. Pritisnite gumb **Izbornik** dva puta da zatvorite OSD.

Donja slika pokazuje izbornik Jezik. Default jezik je engleski.

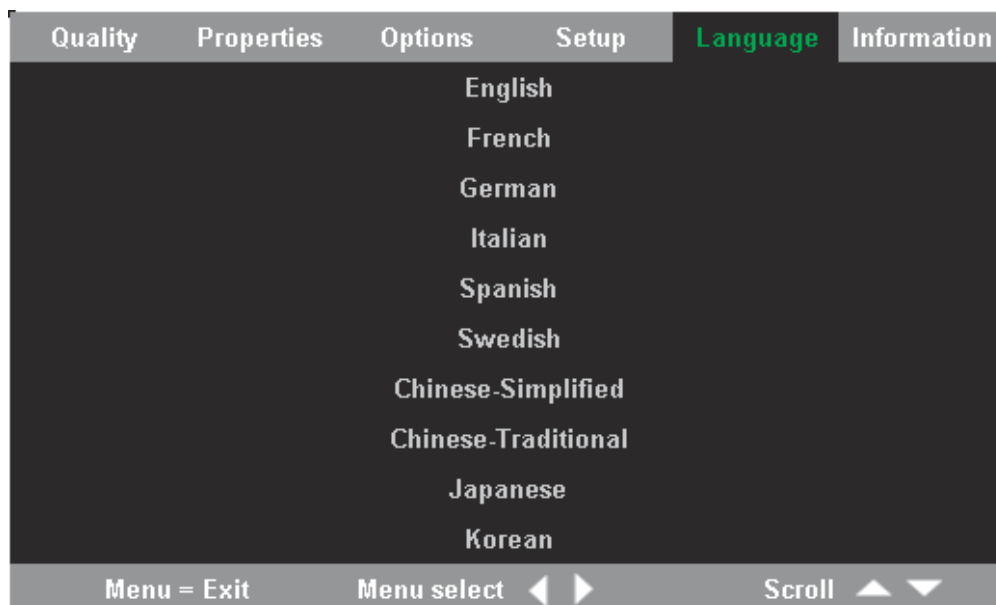

Izbornik Kvaliteta

Izbornik Kvaliteta može biti pronađen kroz glavni meni. Da pristupite meniju Kvaliteta, slijedite ove korake:

1. Pritisnite gumb **Izbornik** i otvorite glavni izbornik.
2. Pritisnite gumb kursora lijevo/desno za prebacivanje na meni Kvaliteta.

3. Pritisnite gumb kursor gore/dolje da se pomaknete gore i dolje u izborniku Kvaliteta. Niže je prikazan meni Kvaliteta.

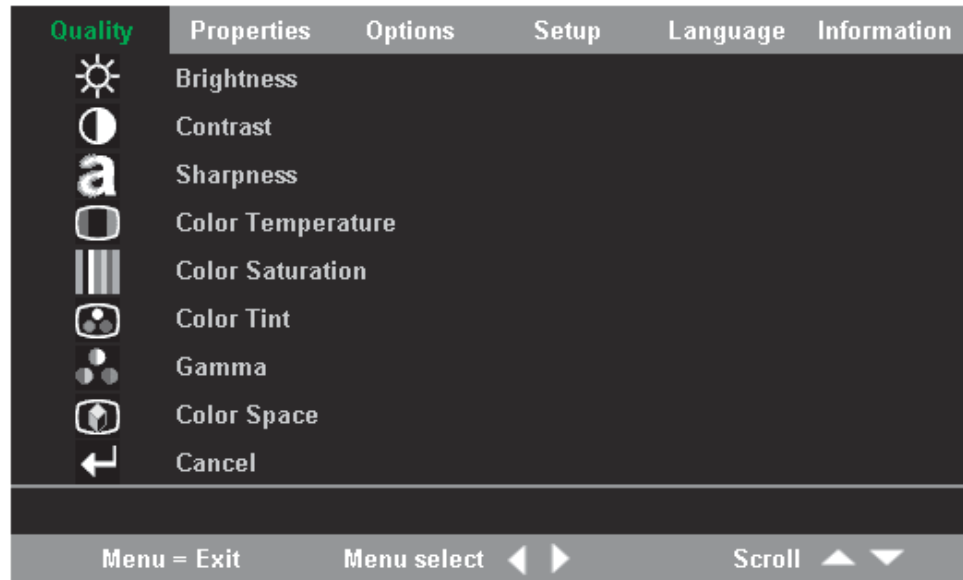

Sljedeća tablica pokazuje opcije koje ćete vidjeti na izborniku Kvaliteta i njihove defaulte.

Stavka	Opis	Default
Sjajnost	Pritisnite gumb kursor lijevo/desno da podesite sjajnost. Raspon: 0 do 100	50
Kontrast	Pritisnite gumb kursor lijevo/desno da podesite kontrast. Raspon: 0 do 100	50
Oštrina	Pritisnite gumb kursor lijevo/desno da podesite oštrinu prikaza. Raspon: 1 do 5	3
Temperatura boje	Pritisnite gumb kursor lijevo/desno da podesite nijansu/ton videa. Raspon: Hladno/Normalno/Toplo	Normalan
Zasićenost boje	Pritisnite gumb kursor lijevo/desno da podesite video zasićenost. Raspon: 0 do 100	50
Nijansa boje	Pritisnite gumb kursor lijevo/desno da podesite nijansu/ton videa. Raspon: 0 do 100	50
Gamma	Pritisnite gumb kursor lijevo/desno da podesite gamma korekciju prikaza. Ulaz/Gamma/Svjetlina: PC/2.2/Visoko, MAC/1.8/Visoko, Video/2.4/Nisko, Chart/2.2/Nisko, B&W/2.4/Visoko	PC

Stavka	Opis	Default
Prostor boje	Pritisnite gumb kursor lijevo/desno da podesite prostor boje. Raspon: Auto/RGB/YpbPr/YCbCr	Auto
Opoziv	Pritisnite gumb Enter da resetirate svjetlinu, kontrast, oštrinu, toplinu boje, zasićenost boje, paletu boje, gammu, i razmak boje od defaultnih vrijednosti.	Nije primjenljivo

Izbornik Svojstva

Izbornik Svojstva može biti pronađen kroz glavni meni. Da pristupite meniju Svojstva, slijedite ove korake:

1. Pritisnite gumb **Izbornik** i otvorite glavni izbornik.
2. Pritisnite gumb kursora lijevo/desno za prebacivanje na meni Svojstva.
3. Pritisnite gumb kursor gore/dolje da se pomaknete gore i dolje u izborniku Svojstva. Niže je prikazan meni Svojstva.



Sljedeća tablica pokazuje opcije koje ćete vidjeti na izborniku Svojstva i njihove defaulte.

Stavka	Opis	Default
Vodoravni položaj	Pritisnite gumb za kursor lijevo/desno da pomaknete sliku lijevo ili desno. Raspon: 0 do 100	50
Okomit položaj	Pritisnite gumb za kursor lijevo/desno da pomaknete sliku gore ili dolje. Raspon: 0 do 100	50
Temeljni položaj	Pritisnite gumb kursor lijevo/desno da ispravite iskrivljenost slike. Raspon: -50 do 50	0

Stavka	Opis	Default
Omjer slike	Pritisnite gumb kursora lijevo/desno da prebacite između standardnog formata 4:3 i formata 16:9 Visoke TV definicije (HDTV). Raspon: 4.3/16.9	4:3
Digitalni zum	Pritisnite gumb Enter da povećate ili smanjite veličinu slike.	Nije primjenljivo
Opoziv	Pritisnite gumb Enter da resetirate Omjer aspekta i Digitalni zum na defaultne vrijednosti.	Nije primjenljivo

Izbornik Opcije

Za pristup do izbornika Opcije slijedite ove korake:

1. Pritisnite gumb Izbornik i otvorite glavni izbornik.
2. Pritisnite gumb kursora lijevo/desno za prebacivanje na meni Opcije.
3. Pritisnite gumb gura gore/dolje da se pomaknete gore i dolje u izborniku Opcije. Niže je prikazan meni Opcije.

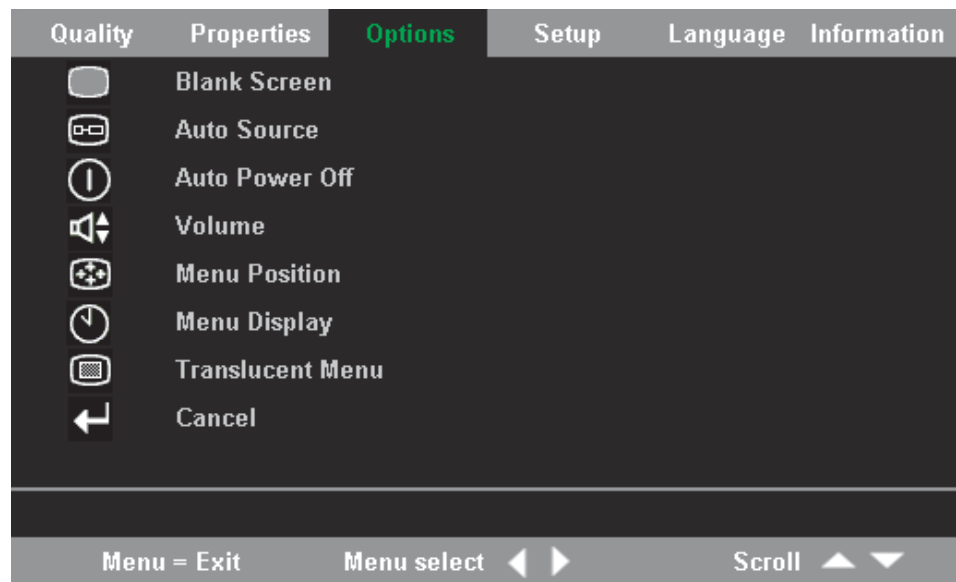

Sljedeća tablica pokazuje opcije koje ćete vidjeti na izborniku Opcije i njihove defaulte.

Stavka	Opis	Default
Prazan ekran	Pritisnite gumb kursora lijevo/desno da izaberete boju pozadine za prazan ekran. Raspon: Crna/Crvena/Zelena/Plava/Bijela	plava
Auto izvor	Pritisnite gumb kursora lijevo/desno da omogućite ili onemogućite automatsko otkrivanje izvora. Raspon: On/Off	On

Stavka	Opis	Default
Auto isključivanje	Pritisnite gumb kursora lijevo/desno da onemogućite automatsko isključivanje lampe nakon 10 minuta neaktivnosti. Raspon: Uključeno/Isključeno	Isključeno
Glasnoća	Pritisnite gumb kursora lijevo da podesite glasnoću. Raspon: 0 - 8	4
Izbornik Položaj	Pritisnite gumb kursora lijevo/desno da smjestite OSD na ekranu. Raspon: Lijevo/Desno/Sredina/Dolje/Gore	Sredina
Prikaz izbornika	Pritisnite gumb kursora lijevo/desno da odredite timeout odgodu OSD-a. Raspon: 10-30 sekundi	15 sekundi
Izbornik Prozirnost	Pritisnite gumb kursora gore/dolje da postavite transparentnost ekrana menija. Raspon: On/Off	Off
Opoziv	Resetira automatsko isključivanje, glasnoću, položaj menija, prikaz menija, i transparentnost menija na defaultne vrijednosti.	Nije primjenljivo

Izbornik Postav

Za pristup do izbornika Postav slijedite ove korake:

1. Pritisnite gumb **Izbornik** i otvorite glavni izbornik.
2. Pritisnite kursora lijevo/desno da se pomaknete na Setup izbornik.
3. Pritisnite gumb kursora gore/dolje da se pomaknete gore i dolje u izborniku Postav. Meni Postav sa jednostrukim ulazom i menijem Postav sa dvostrukim ulazom prikazani su niže.

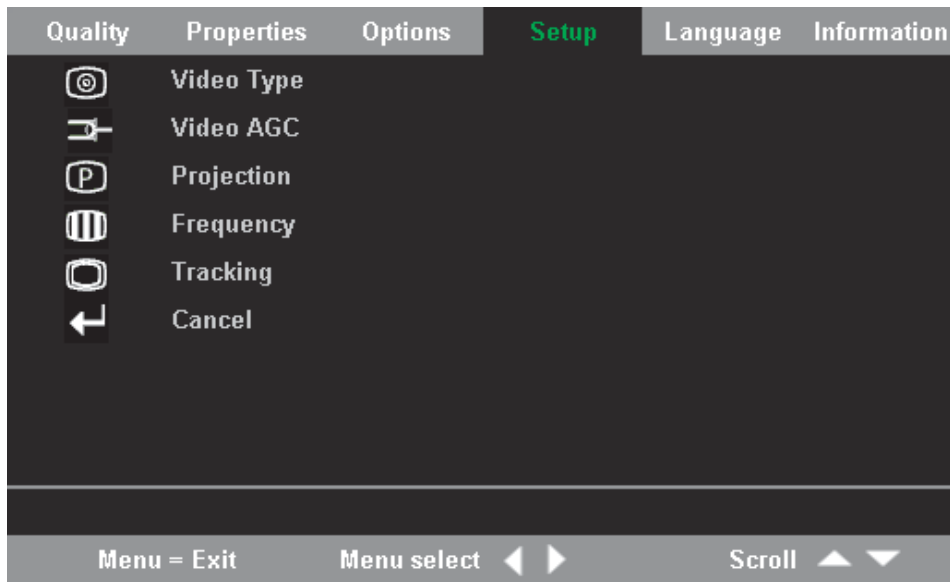

Slika 5-1. Meni Postav sa jednostrukim ulazom

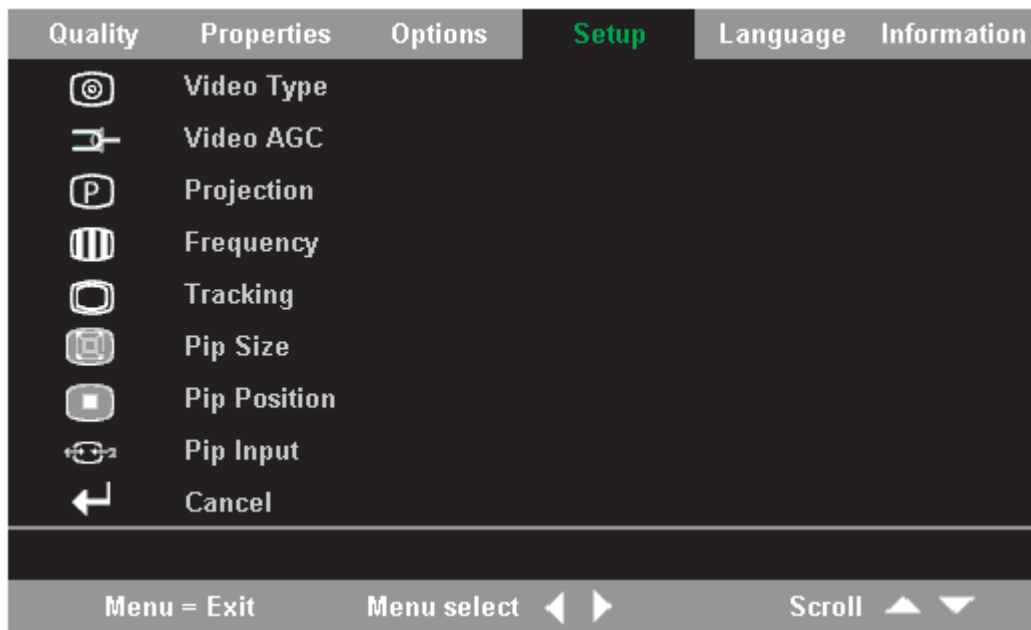

Slika 5-2. Meni Postav sa dvostrukim ulazom

Sljedeća tablica pokazuje opcije koje ćete vidjeti na izborniku Postav i njihove defaulte.

Stavka	Opis	Default
Video tip	Pritisnite gumb kursor lijevo/desno da odaberete video standard. Raspon: Auto/NTSC/PAL/SECAM	Auto

Stavka	Opis	Default
Automatsko podešavanje video kontrole (AGC)	Pritisnite gumb kursor lijevo/desno da omogućite ili onemogućite AGC za video izvor. Raspon: On/Off	On
Projekcija	Pritisnite gumb kursor lijevo/desno da odaberete između četiri metoda projekcije. Raspon: Montirano na stolu, ispred ekrana/montirano na stolu, iza ekrana/montirano na nosaču, ispred ekrana/montirano na nosaču, iza ekrana.	Montirano na stolu, ispred ekrana
Frekvencija	Pritisnite gumb kursor lijevo/desno da podesite sat A/D uzorkovanja. Raspon: 0-100	Automatsko otkrivanje
Praćenje	Pritisnite gumb kursor lijevo/desno da podesite broj A/D uzorkovanja. Raspon: 0-100	Automatsko otkrivanje
Pip veličina	Pritisnite gumb kursor lijevo/desno da podesite veličinu sekundarne slike. Bilješka: Pip veličina dostupna je jedino kada je projektor spojen na dvostruki ulaz. Raspon: Isključeno/Malo/Srednje/Veliko	Isključeno
Pip položaj	Pritisnite gumb kursor lijevo/desno da podesite lokaciju sekundarne slike. Bilješka: Pip položaj dostupna je jedino kada je projektor spojen na dvostruki ulaz. Raspon: Gore lijevo do dolje desno	Gore lijevo
Pip ulaz	Pritisnite gumb kursora lijevo/desno da podesite veličinu sekundarne slike. Bilješka: Pip ulaz dostupan je jedino kada je projektor spojen na dvostruki ulaz. Raspon: Auto/Video/S-video	Auto
Opoziv	Resetira Video tip, Video AGC i Projekciju na default vrijednosti.	N/A

Izbornik Informacije

Za pristup do izbornika Informacije slijedite ove korake:

1. Pritisnite gumb **Izbornik** i otvorite glavni izbornik.
2. Pritisnite gumb kursora lijevo/desno za prebacivanje na Informacijski meni.

3. Pritisnite gumb kursor gore/dolje da se pomaknete gore i dolje u izborniku Informacije. Niže je prikazan Informacijski meni.

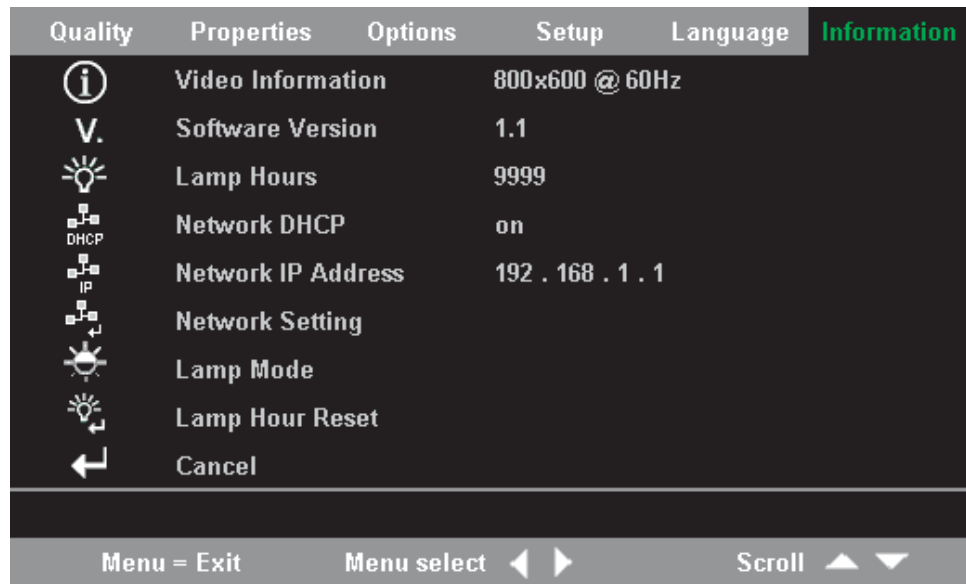

Sljedeća tablica pokazuje opcije koje ćete vidjeti na izborniku Informacijski meni.

Stavka	Opis
Video informacije	Prikazuje rezoluciju i omjer osvježavanja za povezani video uređaj.
Verzija softvera	Prikazuje informacije o firmware verziji.
Sati lampe	Prikazuje sate korištenja lampe.
Mrežni DHCP	Prikazuje statusne informacije DHCP-a.
Mrežna IP adresa	Prikazuje informacije o IP adresi.
Mrežne postavke	Prikazuje izbornik Mrežne postavke.
Način lampe	Prebacuje između načina lampe ECO i Normal. ECO način koristi manje energije, ali smanjuje svjetlinu lampe.
Resetiranje sati lampe	Resetirajte ovu stavku nakon zamjene lampe. Za više informacije, pogledajte “Zamjena lampe u projektoru” na stranici A-1
Opoziv	Resetira način lampe na defaultnu postavku.

Izbornik Mrežne postavke

Za pristup do izbornika Mrežne postavke, slijedite ove korake:

1. Pritisnite gumb **Izbornik** i otvorite glavni izbornik.
2. Pritisnite gumb kursor lijevo/desno za prebacivanje na Informacijski meni.
3. Pritisnite gumb kursor gore/dolje da se pomaknete na Mrežne postavke u izborniku Informacije.
4. Pritisnite gumb kursor lijevo/desno ili gumb Enter da odaberete meni Mrežne postavke. Primjer menija Mrežne postavke prikazan je niže.

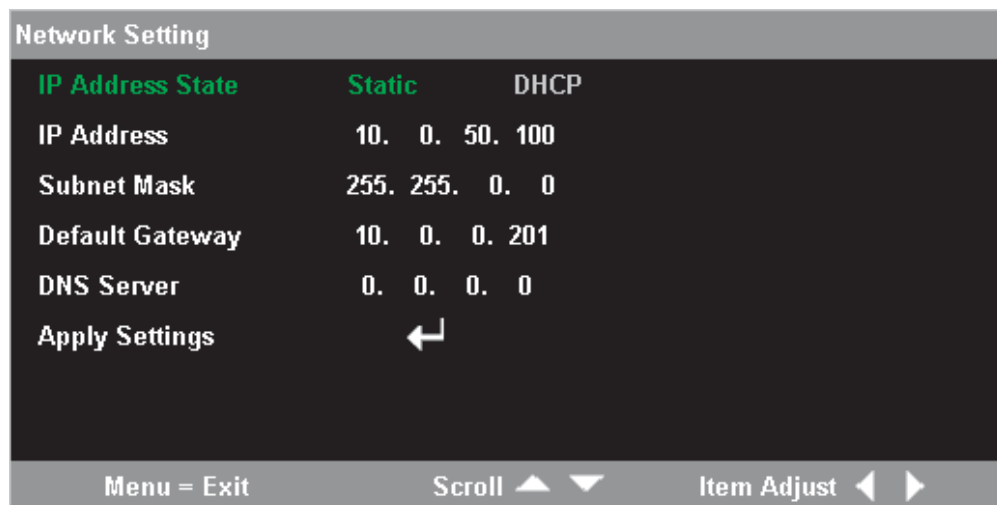

Stavka	Opis
Stanje IP adrese	Pritisnite gumb kursor lijevo/desno da odaberete između postavki Statičko i DHCP. U Statičkom, korisnik može unijeti IP adresu, masku pod mreže, defaultni gateway i DNS poslužitelj. U DHCP-u, projektor će imati postavljenu IP adresu, masku pod mreže, defaultni gateway i DNS poslužitelj. Bilješka: Defaultna postavka je DHCP.
IP Adresa	Pritisnite gumb kursor gore/dolje da promijenite IP adresu. Bilješka: IP adresa može biti promijenjena jedino dok je stanje IP adrese Statičko.
Maska pod mreže	Pritisnite gumb kursor gore/dolje da promijenite masku pod mreže. Bilješka: Maska pod mreže može biti promijenjena jedino kad je stanje IP adrese Statičko.
Defaultni gateway	Pritisnite gumb kursor gore/dolje da promijenite Defaultni gateway. Bilješka: Defaultni gateway može biti promijenjen jedino dok je stanje IP adrese Statičko.
DNS poslužitelj	Pritisnite gumb kursor gore/dolje da promijenite adresu DNS poslužitelja. Bilješka: DNS poslužitelj može biti promijenjen jedino kad je stanje IP adrese Statičko.
Primjeni postavke	Odaberite ovo da spremite i primijenite postavke.

Poglavlje 6. Rad udaljene mreže

Kada ste spojeni na Mrežu lokalnog područja (LAN) putem RJ-45 konektora, možete kontrolirati projektor udaljeno kroz Web pretražitelj putem bilo kojeg klijenta (PC-evi spojeni na LAN) na LAN-u. Projektoru se može pristupiti i izvan LAN-a, ukoliko je vatreni zid ispravno konfiguriran.

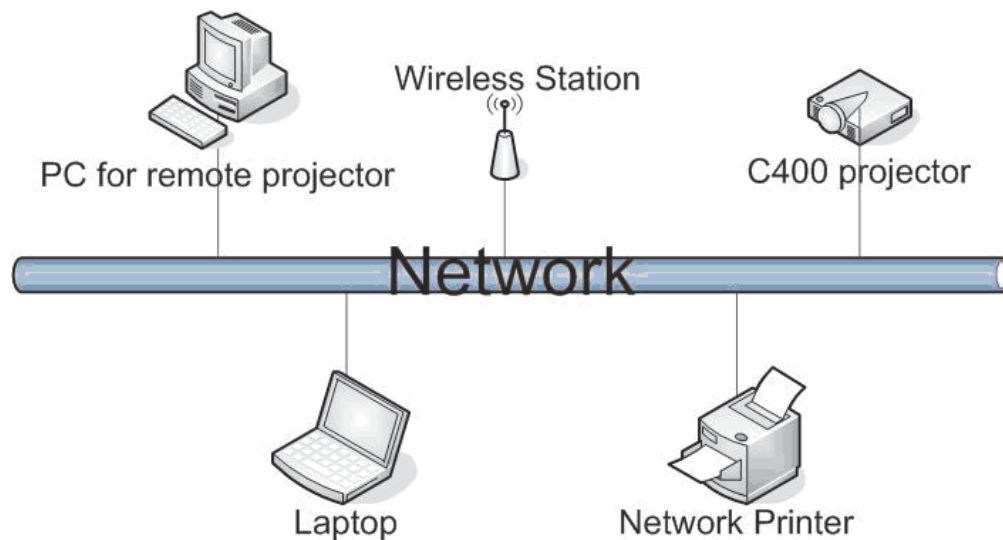

Bilješka: Tvornički default je postavljen na DHCP za projektor. Trenutnu IP adresu možete vidjeti u Informacijskom meniju.

Pregled udaljenog sučelja

Slijedeće prikazuje glavne ekrane udaljenog sučelja.

- **Udaljeno:** Ovaj ekran prikazuje trenutno stanje projektora.

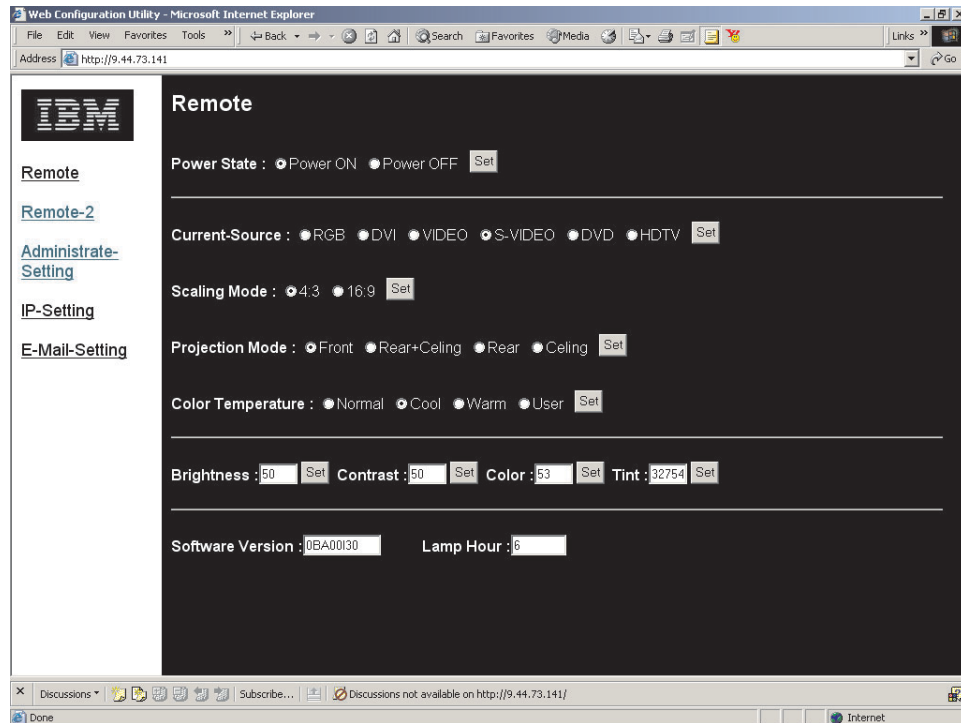

- **Udaljeno-2:** Ovaj ekran isto se koristi za kontrolu projektora.

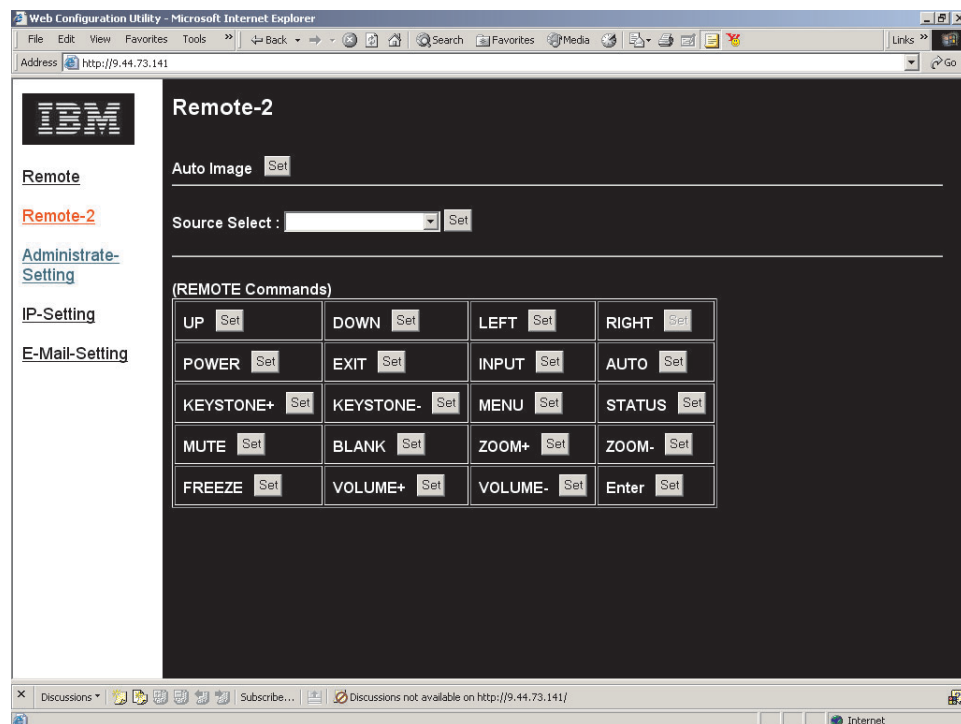

- **Administratorske postavke:** Ovaj ekran dopušta administratoru postavljanje lozinke i ograničenja veze prema projektoru.

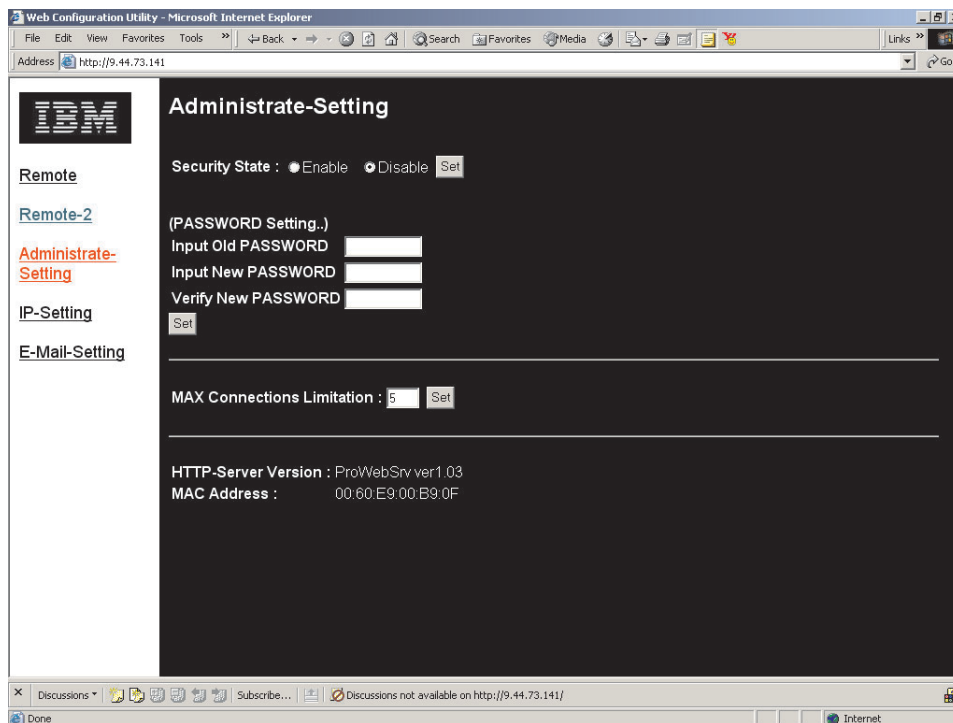

- **IP postavke:** Ovaj ekran dopušta postavljanje IP adrese za Statičko ili DHCP.

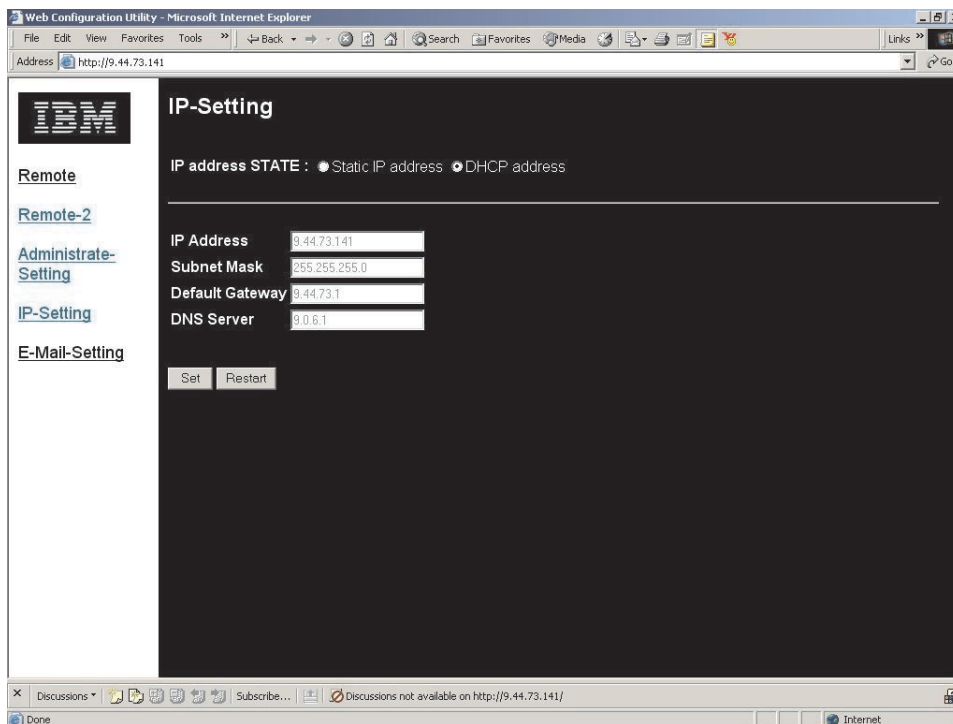

- **Postavke e-pošte:** Poruke o stanju za projektor mogu biti poslone e-poštom administratoru ili na neku drugu adresu.

Neki poslužitelji trebaju adresu pošiljaoca, inače je e-pošta blokirana. U većini slučajeva će tako adrese pošiljaoca i primaoca biti jednake.

Projektor automatski šalje statusne poruke kao IP adresu i stanje napajanja na adresu primaoca. Projektor ne može primiti e-poštu.

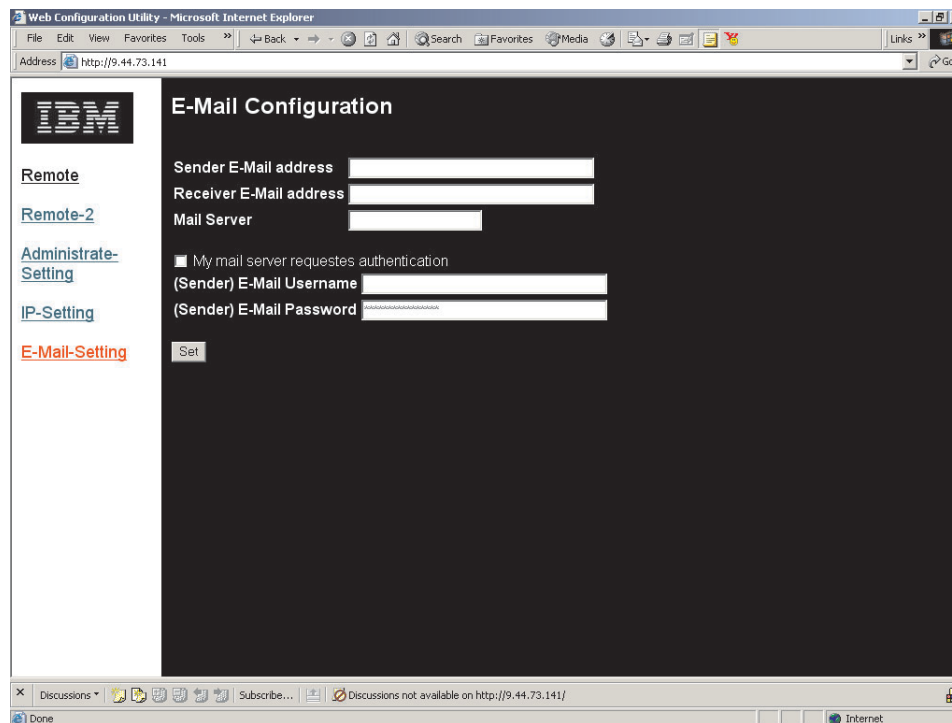

Postavljanje udaljenih operacija

Trebali bi znati neke ili sve od sljedećih postavki:

- IP adresu
- Masku pod mreže
- Defaultni gateway
- DNS poslužitelj
- E-mail adresu udaljenog PC-a
- Lozinku (ukoliko je potrebno) za udaljeni PC
- Izlazni poslužitelj (SMTP) za udaljeni PC

Bilješka: Korištenje proxy poslužitelja za vaš LAN može filtrirati poruke od projektor. Da to spriječite, onemogućite proxy poslužitelj.

Tvornički default je postavljen na DHCP za projektor. Trenutnu adresu možete vidjeti u Informacijskom meniju.

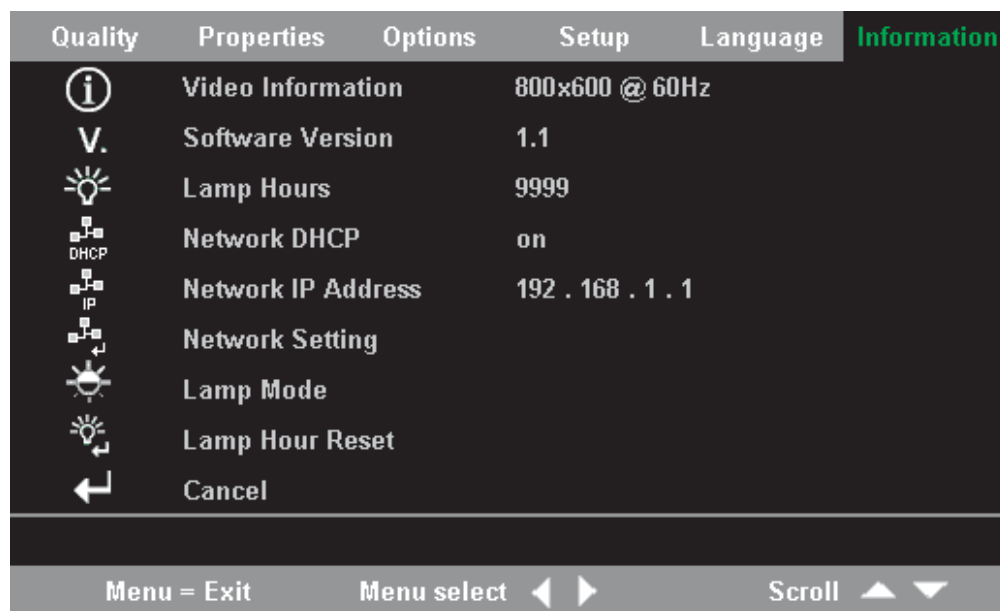

Možete promijeniti postavke u izborniku Mrežne postavke. Za pristup do izbornika Mrežne postavke, slijedite ove korake:

1. Pritisnite gumb Izbornik i otvorite glavni izbornik.
2. Pritisnite gumb kursora lijevo/desno za prebacivanje na Informacijski meni.
3. Pritisnite gumb kursora gore/dolje da se pomaknete na Mrežne postavke u izborniku Informacije.
4. Pritisnite gumb Enter da pristupite izborniku Mrežne postavke. Meni Mrežne postavke prikazan je niže.

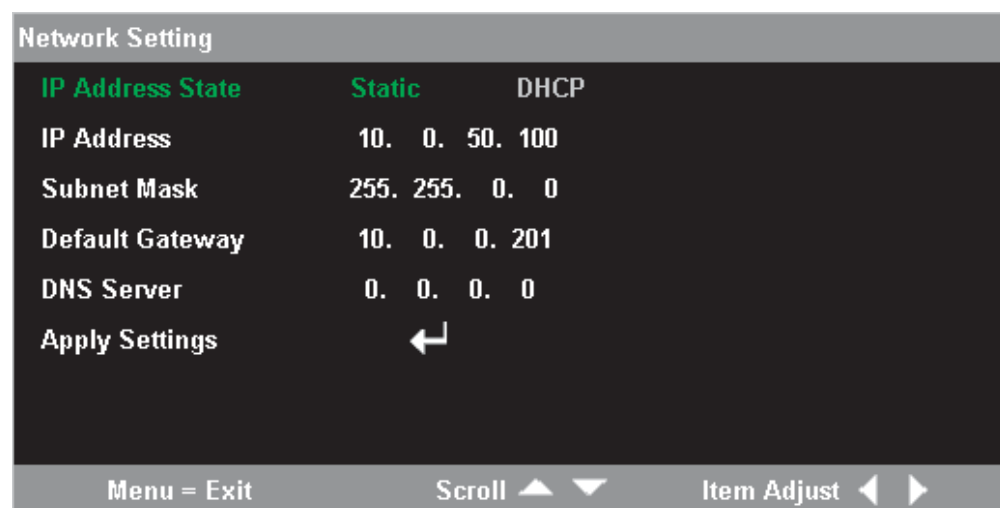

Korištenje DHCP adresnih postavki

Postavite IP postavku na DHCP ukoliko koristite DHCP poslužitelj koji će dodijeliti IP adresu projektoru.

1. Unesite adresu projektoru u adresnu traku vašeg pretražitelja. Primjer: <http://10.0.50.100>

Otvara se udaljena stranica.

2. Kliknite **IP postavke**.

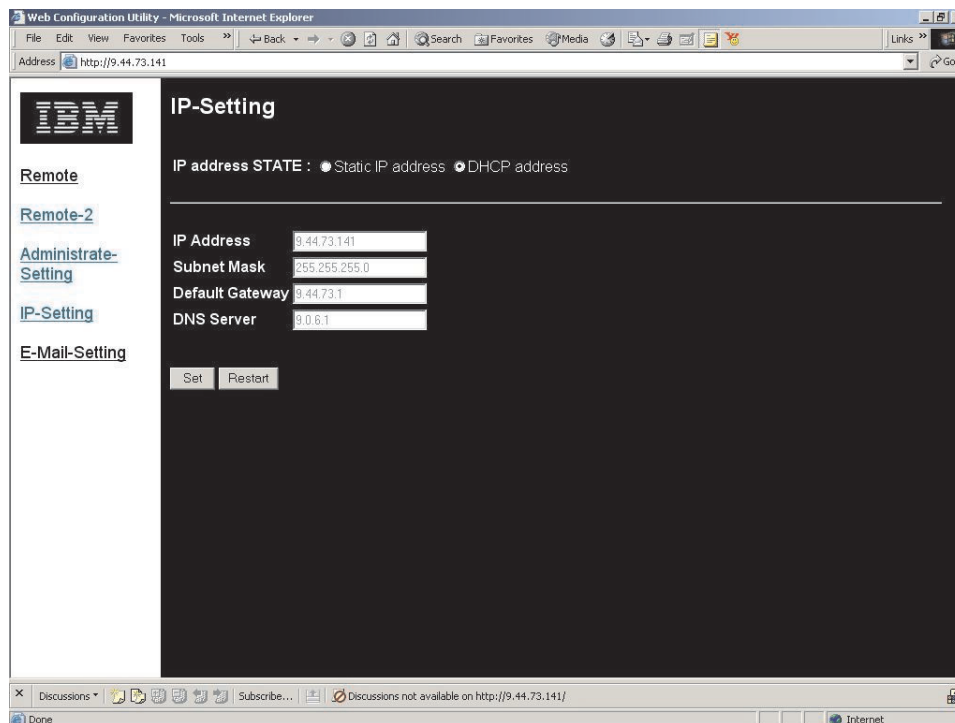

3. Provjerite radio gumb **DHCP adresa** i kliknite **Postavi**.

Omogućavanje i onemogućavanje lozinki

Defaultna postavka je Onemogućeno i nema postavljene lozinke.

1. Kliknite **Administriranje postavki**. Otvara se stranica Administrativne postavke.

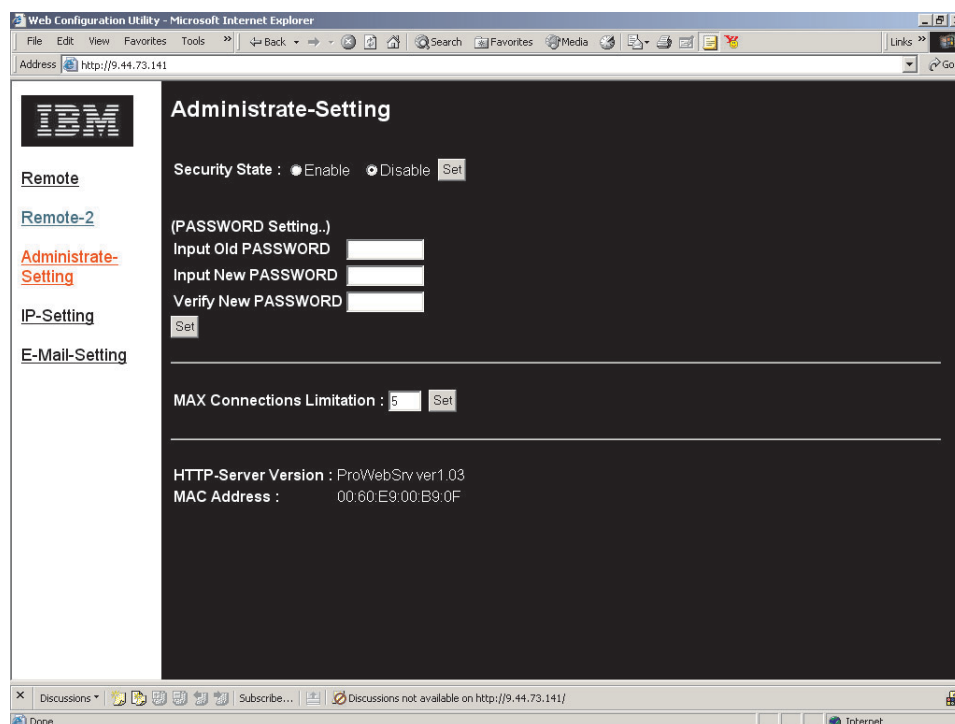

2. Provjerite radio gumb **Omogući** i tada kliknite **Postavi**
ILI
Kliknite radio gumb **Onemogući** i kliknite **Postavi**.

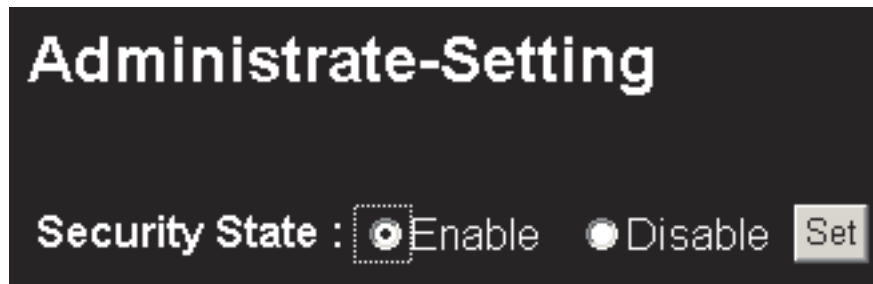

3. Kliknite gumb **Natrag** u vasem pretražitelju da odete na okvir **Unos LOZINKE**



4. Unesite lozinku i kliknite **Prijava**.

Postavljanje najvećeg broja veza

Slijedeće se odnosi na ograničavanje broja korisnika koji se mogu prijaviti na projektor.

1. Kliknite **Administriranje postavki**. Otvara se stranica Administrativne postavke.

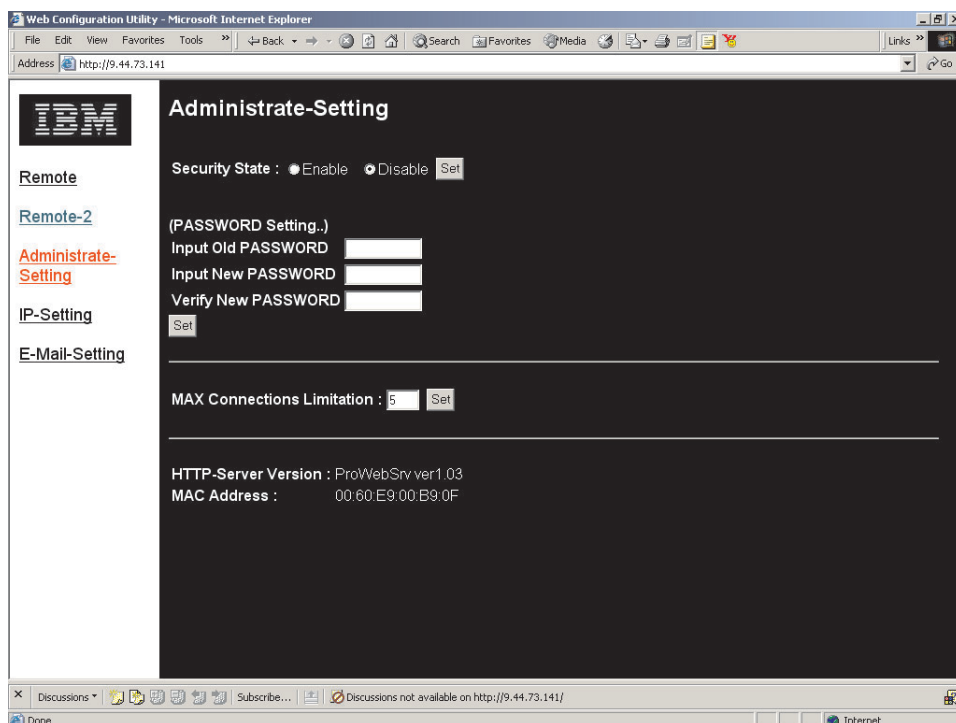

2. Unesite iznos i kliknite **Postavi**.

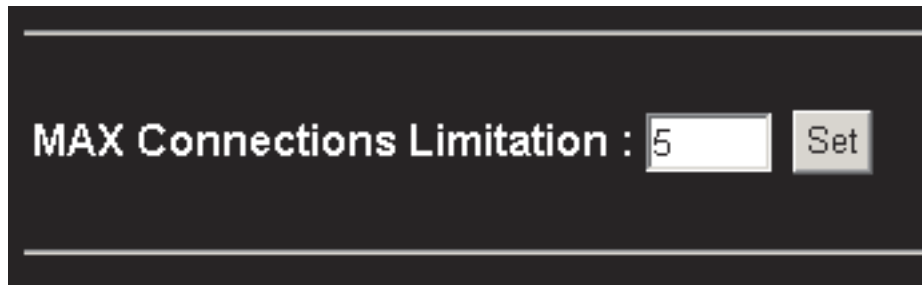

Dohvaćanje zaboravljene lozinke

Slijedeće se odnosi na zaboravljenu lozinku.

1. Provjerite da je **Uključen** radio gumb (pokraj Sigurnosnog statusa) i kliknite **Set**.

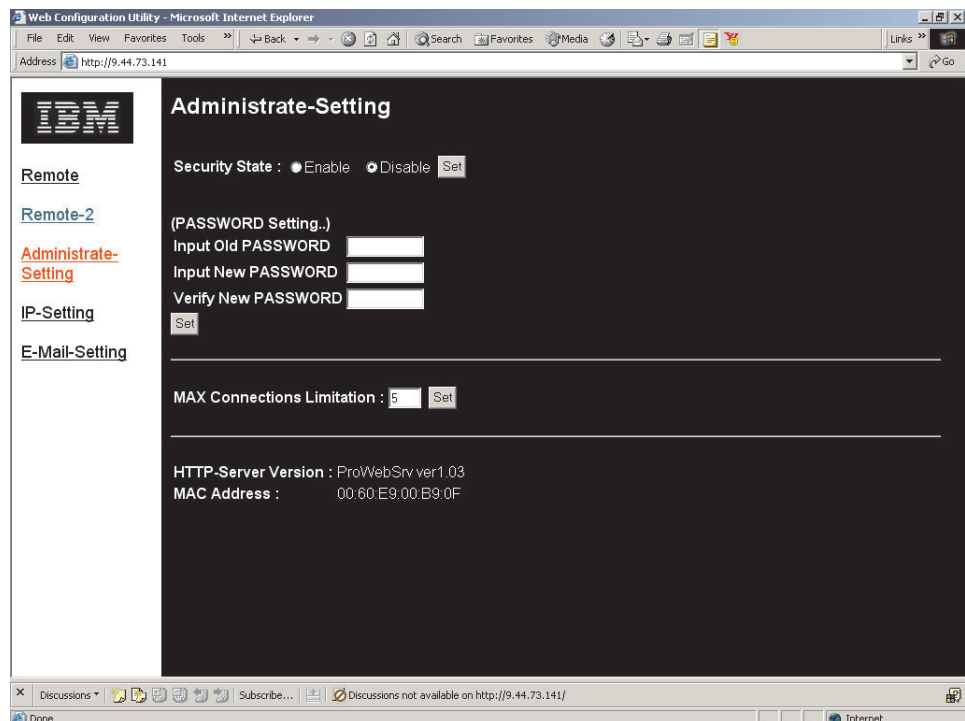

2. Na ekranu Ulazna lozinka, kliknite **Zaboravili ste lozinku?**

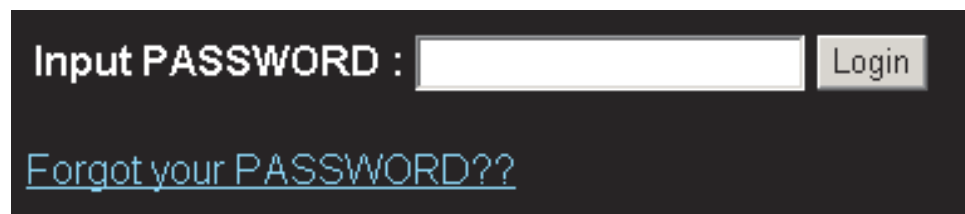

3. Unesite vašu e-poštu i kliknite **Send**.

IF you just forgot your PASSWORD..
Please input the Administrator E-Mail address. System would check
your E-mail address. If matching, then send the PASSWORD to the
administrator.

Your Email :

4. Trenutna lozinka projektora poslana vam je e-poštom.

Dodatak A. Održavanje

Ovo poglavlje osigurava informacije o održavanju projektor.

Čišćenje projektor

Čišćenje projektor od prašine i zaprljanja osigurati će vam njegovo korištenje bez poteškoća.

- Projektor isključite i odspojite najmanje 1 sat prije čišćenja. Ukoliko to ne učinite, može se desiti zapaljenje.
- Kod čišćenja koristite jedino vlažnu tkaninu. Ne dopustite da voda uđe u ventilatorske otvore na projektoru.
- Ukoliko malo vode uđe u unutrašnjost projektor prilikom čišćenja, ostavite ga isključenog u prozračnom prostoru nekoliko sati prije korištenja.
- Ukoliko prilikom čišćenja uđe puno vode u unutrašnjost projektor, tada projektor predajte na servis.

Čišćenje leće

Za čišćenje leće koristite sljedeći postupak:

1. Stavite ne-abrazivno sredstvo za čišćenje leća na meku, suhu tkaninu.

Bilješka: Izbjegavajte upotrebu pretjerane količine sredstva za čišćenje i ne stavljajte sredstvo izravno na leću. Abrazivna sredstva za čišćenje, otapala ili ostale agresivne kemikalije mogu oštetiti leću.

2. Lagano, kružnim pokretima prebrišite leću s tkaninom za čišćenje. Ako ne namjeravate odmah koristiti projektor, stavite poklopac na leću.

Čišćenje kućišta

Slijedite navedene korake za čišćenje kućišta projektor:

1. Obrišite prašinu sa čistom, vlažnom krpom.
2. Navlažite tkaninu sa toplom vodom i blagim deterdžentom (npr. deterdžentom za pranje posuđa), te obrišite kućište.
3. Uklonite deterdžent sa tkanine i ponovno obrišite kućište.

Bilješka: Kako bi spriječili skidanje boje i izbjeljivanje kućišta, nemojte rabiti agresivne čistaće na bazi alkohola.

Zamjena lampe u projektoru

Lampu projektor treba zamijeniti samo s IBM potvrđenim zamjenskim dijelom, koji možete naručiti od vašeg poslovnog partnera ili sa stranice www.ibm.com/pc.

Za zamjenu lampe projektor koristite sljedeći postupak:

1. Isključite projektor, iskopčajte naponsku žicu i ostavite projektor da se hladi bar 1 sat.

2. Upotrijebite odvijač sa Phillips-glavom kako bi uklonili vijak sa prekrivača lampe, kako je prikazano u **1**.
3. Uklonite prekrivač lampe, kako je prikazano na slici **2**.

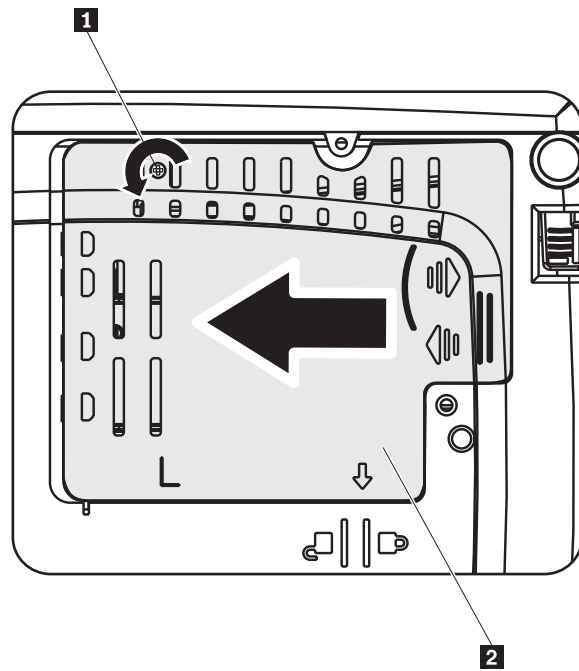

4. Uklonite dva vijka sa modula lampe kako je prikazano na **3**.
5. Podignite hvatište modula i polagano povucite kao na **4**.

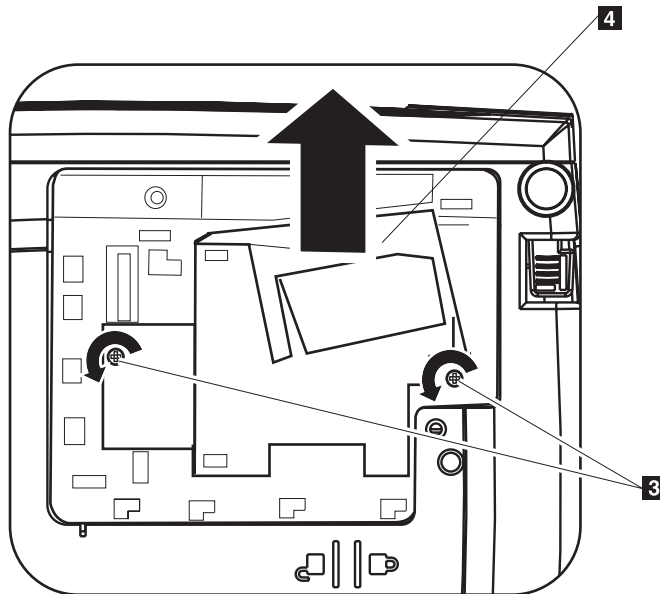

6. Ponovite korake 1 do 5 obrnutim redoslijedom da instalirate novi modul s lampom.

Bilješka: Modul lampe treba biti u položaju kao na slici nakon zamjene.

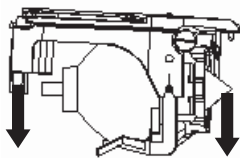

Upozorenje: Ovaj proizvod sadrži lampu s metalnim lukom, koja sadrži živu. Odbacite ga u skladu s lokalnim uredbama i propisima.

SAD ograničava ili zabranjuje odbacivanje nekih ili svih lampi sa živom u gradskim odlagalištima. Molimo posjetite www.lamprecycle.org za više informacija o specifičnim zahtjevima za zbrinjavanje i o mjestima za recikliranje.

Za korisnike u Connecticutu, molimo nazovite Northeast Lamp Recycling besplatno na 1-888-657-5267 i naručite isporuku kompleta za zbrinjavanje u kojem se nalazi kutija za lampu, ljepljiva traka i naljepnica za povratnu otpremu.

Resetiranje timera lampe

Nakon zamjene lampe trebate resetirati brojač sati lampe na nulu. Molimo slijedite donje korake.

1. Pritisnite gumb **Izbornik** i otvorite glavni izbornik.
2. Pritisnite gumb kursor lijevo/desno za prebacivanje na Informacijski meni.
3. Pritisnite gumb kursor gore/dolje da se pomaknete dolje na Resetiranje sata lampe.
4. Pritisnite Enter da odaberete Resetiranje sata lampe.
OSD će prikazati "Molim pogledajte korisnički priručnik..."
5. Pritisnite gumbe na daljinskom ili na projektoru slijedećim redoslijedom: Strelica dolje, Strelica gore, Strelica lijevo, Strelica desno. Ovo će potvrditi resetiranje sata lampe.

Upozorenje: Život lampe je samo mjera slabljenja sjajnosti i nije specifikacija za vrijeme prestanka rada lampe. Život lampe je definiran kao vrijeme koje treba za više od 50% uzoraka lampi za smanjenje sjajnosti za otprilike 50% mjernih lumena za specificiranu lampu. Na primjer, ukoliko je definiran život lampe 1500 sati, a njena sjajnost je 2650 lumena, tada postoji 50% šansa da će lampa preko 1500 sati korištenja imati smanjenu sjajnost 50% ili oko 1325 lumena.

Upotreba sigurnosnog proreza

Projektor sadrži sigurnosni utor, ako na **1**. Pogledajte informacije koje dolaze s bravom radi uputa o tome kako da to koristite.

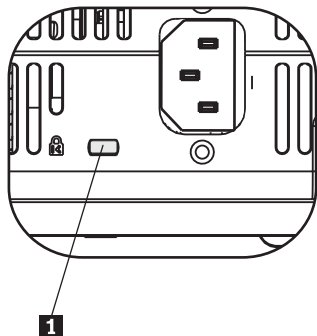

Dodatak B. Rješavanje problema

Ova uputstva pružaju vam savjete za rješavanje problema kod korištenja projektor. Ukoliko problem ostane neriješen, kontaktirajte vašeg zastupnika za pomoć.

Zajednički problemi i rješenja

Provjerite slijedeće prije prelaska na specifična rješenja:

- Koristite drugi električki uređaj da provjerite ispravnost električne utičnice.
- Provjerite da je projektor uključen.
- Provjerite da su sve veze sigurno spojene.
- Provjerite da je spojeni uređaj uključen.
- Provjerite da spojeni PC nije u suspendiranom načinu.
- Provjerite da je povezani laptop konfiguriran za vanjski prikaz. To se obično čini pritiskom kombinacije Fn-tipki na laptopu.

Savjeti za rješavanje problema

U svakom dijelu specifičnog problema, pokušajte izvesti korake u preporučenom redosljedu. Ovo vam može pomoći u bržem rješavanju problema.

Pokušajte ukloniti kvar i tako izbjeći zamjenu ispravnih dijelova. primjer, ukoliko zamijenite baterije i time ne uklonite problem, stavite originalne baterije i pređite na sljedeći korak.

Zapisujte korake kod rješavanja problema. Takve informacije mogu biti korisne kod pozivanja tehničke podrške ili osoblja servisa.

Informacije za rješavanje problema

Sljedeća tablica sadrži informacije o rješavanju problema za projektor. U nekim slučajevima, postoji više od jednog mogućeg rješenja. Koristite rješenja u poretku u kojem su napisana. Kad se problem riješi, možete preskočiti ostala rješenja.

Tablica B-1. Rješavanje problema

Problem	Rješenje
Nema slike na ekranu.	<ul style="list-style-type: none">• Provjerite da li su računalo i projektor uključeni.• Provjerite postavke u vašem prijenosnom računalu ili stolnom PC-u.• Isključite svu opremu i ponovno ju uključite u ispravnom redosljedu.
Slika je nejasna	<ul style="list-style-type: none">• Podesite Fokus na projektoru.• Pritisnite gumb Auto na daljinskom upravljaču ili na projektoru.• Provjerite da li je udaljenost od projektor do ekrana u navedenom rasponu.• Provjerite da li je leća projektor čista.• Osigurajte izlaznu rezoluciju PCa 1024 x 768, lokalnu rezoluciju projektor.

Tablica B-1. Rješavanje problema (nastavak)

Problem	Rješenje
Slika je šira na vrhu ili na dnu (efekt trapeza).	<ul style="list-style-type: none"> • Postavite projektor okomito na ekran, ako je moguće. • Upotrijebite gumb Temeljni položaj na daljinskom upravljaču ili projektoru da ispravite problem.
Slika je obrnuta ili naopaka.	Provjerite postavku Projektor u Setup izborniku OSD-a.
Slika je prugasta.	<ul style="list-style-type: none"> • Postavite postavke za Frekvenciju i Praćenje na izborniku Postav OSD-a na default postavke. • Da provjerite da problem ne uzrokuje povezana PC video kartica, spojite se na drugo računalo.
Slika je blijeda i bez kontrasta	Podesite postavku Kontrast u Glavnom izborniku OSD-a.
Boja projicirane slike ne odgovara izvornoj slici	Podesite postavke Boja Temp. i Gamma na izborniku Upravitelja bojom OSD-a.
Nema svjetla u projektoru	<ul style="list-style-type: none"> • Provjerite da li je naponski kabel ispravno spojen. • Provjerite da li je izvor napajanja ispravan s nekim drugim električnim uređajem. • Ponovno pokrenite projektor u ispravnom poretku i provjerite da je Naponski LED zelen. • Ako ste nedavno zamijenili lampu, pokušajte resetirati veze za lampu. Osigurajte da je poklopac lampe poravnat s kutijom projektoru kad je zatvorena. • Zamijenite modul lampe. • Stavite staru lampu natrag u projektor i dajte projektor na popravak.
Lampa se isključuje.	<ul style="list-style-type: none"> • Udari napona mogu uzrokovati isključivanje lampe. Pritisnite gumb Uključi dva puta da isključite projektor. Kad se Lampa spremna LED uključi, pritisnite gumb Uključi. • Zamijenite s novim modulom lampe. • Stavite staru lampu natrag u projektor i dajte projektor na popravak.
Projektor ne odgovara na daljinski upravljač.	<ul style="list-style-type: none"> • Usmjerite daljinski upravljač prema udaljenom senzoru na projektoru. • Osigurajte da na putu između daljinskog i senzora nema prepreka. • Isključite fluorescentna svjetla u prostoriji. • Provjerite polaritet baterije. • Zamijenite baterije. • Isključite ostale infracrveno-omogućene uređaje u blizini. • Dajte daljinski upravljač na popravak.
Nema zvuka.	<ul style="list-style-type: none"> • Podesite glasnoću na daljinskom upravljaču. • Podesite glasnoću na audio izvoru. • Provjerite vezu audio kabla. • Testirajte izvorni audio izlaz s drugim zvučnicima. • Dajte projektor na popravak.
Zvuk je izobličen.	<ul style="list-style-type: none"> • Provjerite vezu audio kabla. • Testirajte izvorni audio izlaz s drugim zvučnicima. • Dajte projektor na popravak.

Projektor LED-ovi

LED-ovi na vrhu projektoru označavaju stanje projektoru i mogu vam pomoći u rješavanju problema. Postoje pauze od dvije sekunde između ciklusa treperenja. Za više detalja o greškama LED-ova projektoru, kontaktirajte vašeg IBM predstavnika.

Tablica B-2. Poruke grešaka LED-a za spremnost lampe

Broj bljeskova LED-a za spremnost lampe	Objašnjenje
Bljeskajuće	Lampa nije spremna- ne pritiskajte gumb za uključenje dok ne prestane treperenje.
1	Greška ventilatora prednjeg poklopca
2	Greška ventilatora lampe
3	Greška ventilatora ploče napajanja
4	Greška ventilatora topa
5	Greška ventilatora balansera

Tablica B-3. Poruke grešaka za naponski LED

Broj bljeskova naponskog LED-a	Objašnjenje
3	Pregrijavanje sistema
4	Greška sistemskog sučelja
5	Greška lampe
6	Greška ventilatora. Pogledajte LED za spremnost lampe da odredite o kojem ventilatoru se radi.
7	Otvoren je poklopac lampe
8	Greška DLP pogonitelja.

Dodatak C. Specifikacije

Slijede specifikacije za IBM C400 projektor.

Temperatura (kad ne radi)	5° do 35° C (41° do 95° F) na 0 metara nadmorske visine -10° do 60° C (14° do 140° F)
Nadmorska visina (kad radi)	3.048 m (0 do 10.000 stopa)
Nadmorska visina (kad ne radi)	12.192 m (0 do 40.000 stopa)
Vlaga (kad radi)	5% do 90% relativna vlažnost, bez kondenzacije
Vlaga (kad ne radi)	5% do 95% relativna vlažnost, bez kondenzacije
Dimenzije (V x Š x D)	86 mm x 285 mm x 220 mm (3.38 in. x 11.21 in. x 8.66 in.)
Težina	3.1 kg (6.8 lbs) neraspakiran
Optika (raspon fokusa)	1.2 - 9.4 m (4 do 31 stopa)
Tip lampe	250 W lampica
Lumeni	2650 lumena (Ekonomski način: 1850 lumena)
Zahtjevi za ulazni napon	100-240V 4.5A 50/60 Hz

Dodatak D. Service and Support

The following information describes the technical support that is available for your product, during the warranty period or throughout the life of the product. Refer to your IBM Statement of Limited Warranty for a full explanation of IBM warranty terms.

Online technical support

Online technical support is available during the life of your product through the Personal Computing Support Web site at <http://www.ibm.com/pc/support>.

During the warranty period, assistance for replacement or exchange of defective components is available. In addition, if your IBM option is installed in an IBM computer, you might be entitled to service at your location. Your technical support representative can help you determine the best alternative.

Telephone technical support

Installation and configuration support through the IBM Support Center will be withdrawn or made available for a fee, at IBM's discretion, 90 days after the option has been withdrawn from marketing. Additional support offerings, including step-by-step installation assistance, are available for a nominal fee.

To assist the technical support representative, have available as much of the following information as possible:

- Option name
- Option number
- Proof of purchase
- Computer manufacturer, model, serial number (if IBM), and manual
- Exact wording of the error message (if any)
- Description of the problem
- Hardware and software configuration information for your system

If possible, be at your computer. Your technical support representative might want to walk you through the problem during the call.

For the support telephone number and support hours by country, refer to the following table. If the number for your country or region is not listed, contact your IBM reseller or IBM marketing representative. Response time may vary depending on the number and nature of the calls received.

Phone numbers are subject to change without notice. For the latest phone number list, go to <http://www.ibm.com/pc/support> and click **Support Phone List**.

Country or Region	Telephone Number	Country or Region	Telephone Number
Africa	+44 (0) 1475 555 055	Japan	Desktop: 0120-887-870 <ul style="list-style-type: none"> Overseas calls: 81-46-266-1084 ThinkPad: 0120-887-874 <ul style="list-style-type: none"> Overseas calls: 81-46-266-1084 IntelliStation and xSeries: 81-46-266-1358 PC Software: 0120-558-695 <ul style="list-style-type: none"> Overseas calls: 81-44-200-8666
Argentina	0800-666-0011	Luxembourg	298-977-5063
Australia	131-426	Malaysia	(60) 3-7727-7800
Austria	01-24592-5901	Mexico	001-866-434-2080
Bolivia	0800-0189	Middle East	+44 (0) 1475 555 055
Belgium	Dutch: 02-210 9820 French: 02-210 9800	Netherlands	020-514 5770
Brazil	55-11-3889-8986	New Zealand	0800-446-149
Canada	English: 1-800-565-3344 French: 1-800-565-3344 In Toronto: 416-383-3344	Nicaragua	255-6658
Chile	800-224-488	Norway	66 81 11 00
China	800-810-1818	Panama	206-6047
China (Hong Kong and S.A.R.)	Home PC: 852-2825-7799 Commercial PC: 852-8205-0333	Peru	0-800-50-866
Colombia	980-912-3021	Philippines	(63) 2-995-2225
Costa Rica	284-3911	Portugal	21-892-7147
Denmark	45 20 82 00	Russia	095-940-2000
Dominican Republic	566-4755 or 566-5161 ext. 8201 Toll Free within the Dominican Republic: 1-200-1929	Singapore	(65) 1-800-840-9911
Ecuador	1-800-426911 (option #4)	Spain	91-714-7983
El Salvador	250-5696	Sweden	08-477 4420

Country or Region	Telephone Number	Country or Region	Telephone Number
Finland	09-459 69 60	Switzerland	058-333-0900
France	02 38 55 74 50	Taiwan	886-2-8723-9799
Germany	07032-1549 201	Thailand	(66) 2-273-4000
Guatemala	335-8490	Turkey	00-800-446-32-041
Honduras	Tegucigalpa & Sand Pedro Sula: 232-4222 San Pedro Sula: 552-2234	United Kingdom	0-1475-555 055
India	1600-44-6666	United States	1-800-IBM-SERV (1-800-426-7378)
Indonesia	(62) 21-523-8535	Uruguay	000-411-005-6649
Ireland	01-815-9202	Venezuela	0-800-100-2011
Italy	01-815-9202	Vietnam	Ho Chi Minh: (84) 8-829-5160 Hanoi: (84) 4-843-6675

Dodatak E. IBM Statement of Limited Warranty Z125-4753-08 04/2004

Part 1 - General Terms

*This Statement of Limited Warranty includes Part 1 - General Terms, Part 2 - Country-unique Terms, and Part 3 - Warranty Information. The terms of Part 2 replace or modify those of Part 1. The warranties provided by IBM in this Statement of Limited Warranty apply only to Machines you purchase for your use, and not for resale. The term "Machine" means an IBM machine, its features, conversions, upgrades, elements, or accessories, or any combination of them. The term "Machine" does not include any software programs, whether pre-loaded with the Machine, installed subsequently or otherwise. **Nothing in this Statement of Limited Warranty affects any statutory rights of consumers that cannot be waived or limited by contract.***

What this Warranty Covers

*IBM warrants that each Machine 1) is free from defects in materials and workmanship and 2) conforms to IBM's Official Published Specifications ("Specifications") which are available on request. The warranty period for the Machine starts on the original Date of Installation and is specified in Part 3 - Warranty Information. The date on your invoice or sales receipt is the Date of Installation unless IBM or your reseller informs you otherwise. Many features, conversions, or upgrades involve the removal of parts and their return to IBM. A part that replaces a removed part will assume the warranty service status of the removed part. Unless IBM specifies otherwise, these warranties apply only in the country or region in which you purchased the Machine. **THESE WARRANTIES ARE YOUR EXCLUSIVE WARRANTIES AND REPLACE ALL OTHER WARRANTIES OR CONDITIONS, EXPRESS OR IMPLIED, INCLUDING, BUT NOT LIMITED TO, THE IMPLIED WARRANTIES OR CONDITIONS OF MERCHANTABILITY AND FITNESS FOR A PARTICULAR PURPOSE. SOME STATES OR JURISDICTIONS DO NOT ALLOW THE EXCLUSION OF EXPRESS OR IMPLIED WARRANTIES, SO THE ABOVE EXCLUSION MAY NOT APPLY TO YOU. IN THAT EVENT, SUCH WARRANTIES ARE LIMITED IN DURATION TO THE WARRANTY PERIOD. NO WARRANTIES APPLY AFTER THAT PERIOD. SOME STATES OR JURISDICTIONS DO NOT ALLOW LIMITATIONS ON HOW LONG AN IMPLIED WARRANTY LASTS, SO THE ABOVE LIMITATION MAY NOT APPLY TO YOU.***

What this Warranty Does not Cover

This warranty does not cover the following:

- any software programs, whether pre-loaded or shipped with the Machine, or installed subsequently;
- failure resulting from misuse (including but not limited to use of any Machine capacity or capability, other than that authorized by IBM in writing), accident, modification, unsuitable physical or operating environment, or improper maintenance by you;
- failure caused by a product for which IBM is not responsible; and
- any non-IBM products, including those that IBM may procure and provide with or integrate into an IBM Machine at your request.

The warranty is voided by removal or alteration of identification labels on the Machine or its parts.

IBM does not warrant uninterrupted or error-free operation of a Machine.

Any technical or other support provided for a Machine under warranty, such as assistance with "how-to" questions and those regarding Machine set-up and installation, is provided **WITHOUT WARRANTIES OF ANY KIND.**

How to Obtain Warranty Service

If the Machine does not function as warranted during the warranty period, contact IBM or your reseller to obtain warranty service. If you do not register the Machine with IBM, you may be required to present proof of purchase as evidence of your entitlement to warranty service.

What IBM Will Do to Correct Problems

When you contact IBM for service, you must follow the problem determination and resolution procedures that IBM specifies. An initial diagnosis of your problem can be made either by a technician over the telephone or electronically by access to an IBM website. The type of warranty service applicable to your Machine is specified in Part 3 - Warranty Information. You are responsible for downloading and installing designated Machine Code (microcode, basic input/output system code (called "BIOS"), utility programs, device drivers, and diagnostics delivered with an IBM Machine) and other software updates from an IBM Internet Web site or from other electronic media, and following the instructions that IBM provides. If your problem can be resolved with a Customer Replaceable Unit ("CRU") (e.g., keyboard, mouse, speaker, memory, hard disk drive), IBM will ship the CRU to you for you to install. If the Machine does not function as warranted during the warranty period and your problem cannot be resolved over the telephone or electronically, through your application of Machine Code or software updates, or with a CRU, IBM or your reseller, if approved by IBM to provide warranty service, will either, at its discretion, 1) repair it to make it function as warranted, or 2) replace it with one that is at least functionally equivalent. If IBM is unable to do either, you may return the Machine to your place of purchase and your money will be refunded. IBM or your reseller will also manage and install selected engineering changes that apply to the Machine.

Exchange of a Machine or Part

When the warranty service involves the exchange of a Machine or part, the item IBM or your reseller replaces becomes its property and the replacement becomes yours. You represent that all removed items are genuine and unaltered. The replacement may not be new, but will be in good working order and at least functionally equivalent to the item replaced. The replacement assumes the warranty service status of the replaced item.

Your Additional Responsibilities

Before IBM or your reseller exchanges a Machine or part, you agree to remove all features, parts, options, alterations, and attachments not under warranty service.

You also agree to:

1. ensure that the Machine is free of any legal obligations or restrictions that prevent its exchange;
2. obtain authorization from the owner to have IBM or your reseller service a Machine that you do not own; and
3. where applicable, before service is provided:
 - a. follow the service request procedures that IBM or your reseller provides;
 - b. backup or secure all programs, data, and funds contained in the Machine;
 - c. provide IBM or your reseller with sufficient, free, and safe access to your facilities to permit IBM to fulfill its obligations; and
 - d. inform IBM or your reseller of changes in the Machine's location.
4. (a) ensure all information about identified or identifiable individuals (Personal Data) is deleted from the Machine (to the extent technically possible), (b) allow IBM, your reseller or an IBM supplier to process on your behalf any remaining Personal Data as IBM or your reseller considers necessary to fulfill its obligations under this Statement of Limited Warranty (which may include shipping the Machine for such processing to other IBM service locations around the world), and (c) ensure that such processing complies with any laws applicable to such Personal Data.

Limitation of Liability

IBM is responsible for loss of, or damage to, your Machine only while it is 1) in IBM's possession or 2) in transit in those cases where IBM is responsible for the transportation charges.

Neither IBM nor your reseller are responsible for any of your confidential, proprietary or personal information contained in a Machine which you return to IBM for any reason. You should remove all such information from the Machine prior to its return.

Circumstances may arise where, because of a default on IBM's part or other liability, you are entitled to recover damages from IBM. In each such instance, regardless of the basis on which you are entitled to claim damages from IBM (including fundamental breach, negligence, misrepresentation, or other contract or tort claim), except for any liability that cannot be waived or limited by applicable laws, IBM is liable for no more than

1. damages for bodily injury (including death) and damage to real property and tangible personal property; and
2. the amount of any other actual direct damages, up to the charges (if recurring, 12 months' charges apply) for the Machine that is subject of the claim. For purposes of this item, the term "Machine" includes Machine Code and Licensed Internal Code ("LIC").

This limit also applies to IBM's suppliers and your reseller. It is the maximum for which IBM, its suppliers, and your reseller are collectively responsible.

UNDER NO CIRCUMSTANCES IS IBM, ITS SUPPLIERS OR RESELLERS LIABLE FOR ANY OF THE FOLLOWING EVEN IF INFORMED OF THEIR POSSIBILITY: 1) THIRD PARTY CLAIMS AGAINST YOU FOR DAMAGES (OTHER THAN THOSE UNDER THE FIRST ITEM LISTED ABOVE); 2) LOSS OF, OR DAMAGE TO, DATA; 3) SPECIAL, INCIDENTAL, OR INDIRECT DAMAGES OR FOR ANY ECONOMIC CONSEQUENTIAL DAMAGES; OR 4) LOST PROFITS, BUSINESS REVENUE, GOODWILL OR ANTICIPATED SAVINGS. SOME STATES OR JURISDICTIONS DO NOT ALLOW THE EXCLUSION OR LIMITATION OF INCIDENTAL OR CONSEQUENTIAL DAMAGES, SO THE ABOVE LIMITATION OR EXCLUSION MAY NOT APPLY TO YOU. SOME STATES OR JURISDICTIONS DO NOT ALLOW LIMITATIONS ON HOW LONG AN IMPLIED WARRANTY LASTS, SO THE ABOVE LIMITATION MAY NOT APPLY TO YOU.

Governing Law

Both you and IBM consent to the application of the laws of the country in which you acquired the Machine to govern, interpret, and enforce all of your and IBM's rights, duties, and obligations arising from, or relating in any manner to, the subject matter of this Statement of Limited Warranty, without regard to conflict of law principles.

THESE WARRANTIES GIVE YOU SPECIFIC LEGAL RIGHTS AND YOU MAY ALSO HAVE OTHER RIGHTS WHICH VARY FROM STATE TO STATE OR JURISDICTION TO JURISDICTION.

Jurisdiction

All of our rights, duties, and obligations are subject to the courts of the country in which you acquired the Machine.

Part 2 - Country-unique Terms

AMERICAS

ARGENTINA

Jurisdiction: *The following is added after the first sentence:*

Any litigation arising from this Statement of Limited Warranty will be settled exclusively by the Ordinary Commercial Court of the city of Buenos Aires.

BOLIVIA

Jurisdiction: *The following is added after the first sentence:*

Any litigation arising from this Statement of Limited Warranty will be settled exclusively by the courts of the city of La Paz.

BRAZIL

Jurisdiction: *The following is added after the first sentence:*

Any litigation arising from this Agreement will be settled exclusively by the court of Rio de Janeiro, RJ.

CHILE

Jurisdiction: *The following is added after the first sentence:*

Any litigation arising from this Statement of Limited Warranty will be settled exclusively by the Civil Courts of Justice of Santiago.

COLOMBIA

Jurisdiction: *The following is added after the first sentence:*

Any litigation arising from this Statement of Limited Warranty will be settled exclusively by the Judges of the Republic of Colombia.

EQUADOR

Jurisdiction: *The following is added after the first sentence:*

Any litigation arising from this Statement of Limited Warranty will be settled exclusively by the Judges of Quito.

MEXICO

Jurisdiction: *The following is added after the first sentence:*

Any litigation arising from this Statement of Limited Warranty will be settled exclusively by the Federal Courts of Mexico City, Federal District.

PARAGUAY

Jurisdiction: *The following is added after the first sentence:*

Any litigation arising from this Statement of Limited Warranty will be settled exclusively by the courts of the city of Asuncion.

PERU

Jurisdiction: *The following is added after the first sentence:*

Any litigation arising from this Statement of Limited Warranty will be settled exclusively by the Judges and Tribunals of the Judicial District of Lima, Cercado.

Limitation of Liability: *The following is added at the end of this section:* In accordance with Article 1328 of the Peruvian Civil Code the limitations and exclusions specified in this section will not apply to damages caused by IBM's willful misconduct ("dolo") or gross negligence ("culpa inexcusable").

URUGUAY

Jurisdiction: *The following is added after the first sentence:*

Any litigation arising from this Statement of Limited Warranty will be settled exclusively by the City of Montevideo Court's Jurisdiction.

VENEZUELA

Jurisdiction: *The following is added after the first sentence:*

Any litigation arising from this Statement of Limited Warranty will be settled exclusively by the Courts of the Metropolitan Area Of the City of Caracas.

NORTH AMERICA

How to Obtain Warranty Service: *The following is added to this Section:*

To obtain warranty service from IBM in Canada or the United States, call 1-800-IBM-SERV (426-7378).

CANADA

Limitation of Liability: *The following replaces item 1 of this section:*

1. damages for bodily injury (including death) or physical harm to real property and tangible personal property caused by IBM's negligence; and

Governing Law: *The following replaces "laws of the country in which you acquired the Machine" in the first sentence:*

laws in the Province of Ontario.

UNITED STATES

Governing Law: *The following replaces "laws of the country in which you acquired the Machine" in the first sentence:*

laws of the State of New York.

ASIA PACIFIC

AUSTRALIA

What this Warranty Covers: *The following paragraph is added to this Section:*

The warranties specified in this Section are in addition to any rights you may have under the Trade Practices Act 1974 or other similar legislation and are only limited to the extent permitted by the applicable legislation.

Limitation of Liability: *The following is added to this Section:*

Where IBM is in breach of a condition or warranty implied by the Trade Practices Act 1974 or other similar legislation, IBM's liability is limited to the repair or replacement of the goods or the supply of equivalent goods. Where that condition or warranty relates to right to sell, quiet possession or clear title, or the goods are of a kind ordinarily acquired for personal, domestic or household use or consumption, then none of the limitations in this paragraph apply.

Governing Law: *The following replaces "laws of the country in which you acquired the Machine" in the first sentence:*

laws of the State or Territory.

CAMBODIA AND LAOS

Governing Law: *The following replaces "laws of the country in which you acquired the Machine" in the first sentence:*

laws of the State of New York, United States of America.

CAMBODIA, INDONESIA, AND LAOS

Arbitration: *The following is added under this heading:*

Disputes arising out of or in connection with this Statement of Limited Warranty shall be finally settled by arbitration which shall be held in Singapore in accordance with the Arbitration Rules of Singapore International Arbitration Center ("SIAC Rules") then in effect. The arbitration award shall be final and binding for the parties without appeal and shall be in writing and set forth the findings of fact and the conclusions of law. The number of arbitrators shall be three, with each side to the dispute being entitled to appoint one arbitrator. The two arbitrators appointed by the parties shall appoint a third arbitrator who shall act as chairman of the proceedings. Vacancies in the post of chairman shall be filled by the president of the SIAC. Other vacancies shall be filled by the respective nominating party. Proceedings shall continue from the stage they were at when the vacancy occurred. If one of the parties refuses or otherwise fails to appoint an arbitrator within 30 days of the date the other party appoints its, the first appointed arbitrator shall be the sole arbitrator, provided that the arbitrator was validly and properly appointed. All proceedings shall be conducted, including all documents

presented in such proceedings, in the English language. The English language version of this Statement of Limited Warranty prevails over any other language version.

HONG KONG S.A.R. OF CHINA AND MACAU S.A.R. OF CHINA

Governing Law: *The following replaces "laws of the country in which you acquired the Machine" in the first sentence:*
laws of Hong Kong Special Administrative Region of China.

INDIA

Limitation of Liability: *The following replaces items 1 and 2 of this Section:*

1. liability for bodily injury (including death) or damage to real property and tangible personal property will be limited to that caused by IBM's negligence; and
2. as to any other actual damage arising in any situation involving nonperformance by IBM pursuant to, or in any way related to the subject of this Statement of Limited Warranty, the charge paid by you for the individual Machine that is the subject of the claim. For purposes of this item, the term "Machine" includes Machine Code and Licensed Internal Code ("LIC").

Arbitration: *The following is added under this heading*

Disputes arising out of or in connection with this Statement of Limited Warranty shall be finally settled by arbitration which shall be held in Bangalore, India in accordance with the laws of India then in effect. The arbitration award shall be final and binding for the parties without appeal and shall be in writing and set forth the findings of fact and the conclusions of law. The number of arbitrators shall be three, with each side to the dispute being entitled to appoint one arbitrator. The two arbitrators appointed by the parties shall appoint a third arbitrator who shall act as chairman of the proceedings. Vacancies in the post of chairman shall be filled by the president of the Bar Council of India. Other vacancies shall be filled by the respective nominating party. Proceedings shall continue from the stage they were at when the vacancy occurred. If one of the parties refuses or otherwise fails to appoint an arbitrator within 30 days of the date the other party appoints its, the first appointed arbitrator shall be the sole arbitrator, provided that the arbitrator was validly and properly appointed. All proceedings shall be conducted, including all documents presented in such proceedings, in the English language. The English language version of this Statement of Limited Warranty prevails over any other language version.

JAPAN

Governing Law: *The following sentence is added to this Section:*

Any doubts concerning this Statement of Limited Warranty will be initially resolved between us in good faith and in accordance with the principle of mutual trust.

MALAYSIA

Limitation of Liability: The word "*SPECIAL*" in item 3 of the fifth paragraph is deleted.

NEW ZEALAND

What this Warranty Covers: *The following paragraph is added to this Section:*

The warranties specified in this section are in addition to any rights you may have under the Consumer Guarantees Act 1993 or other legislation which cannot be excluded or limited. The Consumer Guarantees Act 1993 will not apply in respect of any goods which IBM provides, if you require the goods for the purposes of a business as defined in that Act.

Limitation of Liability: *The following is added to this Section:*

Where Machines are not acquired for the purposes of a business as defined in the Consumer Guarantees Act 1993, the limitations in this Section are subject to the limitations in that Act.

PEOPLE'S REPUBLIC OF CHINA (PRC)

Governing Law: *The following replaces "laws of the country in which you acquired the*

Machine" in the first sentence:

laws of the State of New York, United States of America (except when local law requires otherwise).

PHILIPPINES

Limitation of Liability: *Item 3 in the fifth paragraph is replaced by the following: SPECIAL (INCLUDING NOMINAL AND EXEMPLARY DAMAGES), MORAL, INCIDENTAL, OR INDIRECT DAMAGES FOR ANY ECONOMIC CONSEQUENTIAL DAMAGES; OR*

Arbitration: The following is added: under this heading

Disputes arising out of or in connection with this Statement of Limited Warranty shall be finally settled by arbitration which shall be held in Metro Manila, Philippines in accordance with the laws of the Philippines then in effect. The arbitration award shall be final and binding for the parties without appeal and shall be in writing and set forth the findings of fact and the conclusions of law. The number of arbitrators shall be three, with each side to the dispute being entitled to appoint one arbitrator. The two arbitrators appointed by the parties shall appoint a third arbitrator who shall act as chairman of the proceedings. Vacancies in the post of chairman shall be filled by the president of the Philippine Dispute Resolution Center, Inc.. Other vacancies shall be filled by the respective nominating party. Proceedings shall continue from the stage they were at when the vacancy occurred. If one of the parties refuses or otherwise fails to appoint an arbitrator within 30 days of the date the other party appoints its, the first appointed arbitrator shall be the sole arbitrator, provided that the arbitrator was validly and properly appointed. All proceedings shall be conducted, including all documents presented in such proceedings, in the English language. The English language version of this Statement of Limited Warranty prevails over any other language version.

SINGAPORE

Limitation of Liability: *The words "SPECIAL" and "ECONOMIC" in item 3 in the fifth paragraph are deleted.*

EUROPE, MIDDLE EAST, AFRICA (EMEA)

THE FOLLOWING TERMS APPLY TO ALL EMEA COUNTRIES:

The terms of this Statement of Limited Warranty apply to Machines purchased from IBM or an IBM reseller.

How to Obtain Warranty Service:

*Add the following paragraph in **Western Europe** (Andorra, Austria, Belgium, Cyprus, Czech Republic, Denmark, Estonia, Finland, France, Germany, Greece, Hungary, Iceland, Ireland, Italy, Latvia, Liechtenstein, Lithuania, Luxembourg, Malta, Monaco, Netherlands, Norway, Poland, Portugal, San Marino, Slovakia, Slovenia, Spain, Sweden, Switzerland, United Kingdom, Vatican State, and any country subsequently added to the European Union, as from the date of accession):* The warranty for Machines acquired in Western Europe shall be valid and applicable in all Western Europe countries provided the Machines have been announced and made available in such countries. If you purchase a Machine in one of the Western European countries, as defined above, you may obtain warranty service for that Machine in any of those countries from either (1) an IBM reseller approved to perform warranty service or (2) from IBM, provided the Machine has been announced and made available by IBM in the country in which you wish to obtain service. If you purchased a Personal Computer Machine in Albania, Armenia, Belarus, Bosnia and Herzegovina, Bulgaria, Croatia, Czech Republic, Georgia, Hungary, Kazakhstan, Kyrgyzstan, Federal Republic of Yugoslavia, Former Yugoslav Republic of Macedonia (FYROM), Moldova, Poland, Romania, Russia, Slovak Republic, Slovenia, or Ukraine, you may obtain warranty service for that Machine in any of those countries from either (1) an IBM reseller approved to perform warranty service or (2) from IBM. If you purchase a Machine in a Middle Eastern or African country, you may obtain warranty service for that Machine from the IBM entity within the country of purchase,

if that IBM entity provides warranty service in that country, or from an IBM reseller, approved by IBM to perform warranty service on that Machine in that country. Warranty service in Africa is available within 50 kilometers of an IBM approved service provider. You are responsible for transportation costs for Machines located outside 50 kilometers of an IBM approved service provider.

Governing Law:

The phrase "the laws of the country in which you acquired the Machine" is replaced by:

1) "the laws of Austria" in **Albania, Armenia, Azerbaijan, Belarus, Bosnia-Herzegovina, Bulgaria, Croatia, Georgia, Hungary, Kazakhstan, Kyrgyzstan, FYR Macedonia, Moldova, Poland, Romania, Russia, Slovakia, Slovenia, Tajikistan, Turkmenistan, Ukraine, Uzbekistan, and FR Yugoslavia;** 2) "the laws of France" in **Algeria, Benin, Burkina Faso, Cameroon, Cape Verde, Central African Republic, Chad, Comoros, Congo Republic, Djibouti, Democratic Republic of Congo, Equatorial Guinea, French Guiana, French Polynesia, Gabon, Gambia, Guinea, Guinea-Bissau, Ivory Coast, Lebanon, Madagascar, Mali, Mauritania, Mauritius, Mayotte, Morocco, New Caledonia, Niger, Reunion, Senegal, Seychelles, Togo, Tunisia, Vanuatu, and Wallis & Futuna;** 3) "the laws of Finland" in **Estonia, Latvia, and Lithuania;** 4) "the laws of England" in **Angola, Bahrain, Botswana, Burundi, Egypt, Eritrea, Ethiopia, Ghana, Jordan, Kenya, Kuwait, Liberia, Malawi, Malta, Mozambique, Nigeria, Oman, Pakistan, Qatar, Rwanda, Sao Tome, Saudi Arabia, Sierra Leone, Somalia, Tanzania, Uganda, United Arab Emirates, the United Kingdom, West Bank/Gaza, Yemen, Zambia, and Zimbabwe;** and 5) "the laws of South Africa" in **South Africa, Namibia, Lesotho and Swaziland.**

Jurisdiction: *The following exceptions are added to this section:*

1) In **Austria** the choice of jurisdiction for all disputes arising out of this Statement of Limited Warranty and relating thereto, including its existence, will be the competent court of law in Vienna, Austria (Inner-City); 2) in **Angola, Bahrain, Botswana, Burundi, Egypt, Eritrea, Ethiopia, Ghana, Jordan, Kenya, Kuwait, Liberia, Malawi, Malta, Mozambique, Nigeria, Oman, Pakistan, Qatar, Rwanda, Sao Tome, Saudi Arabia, Sierra Leone, Somalia, Tanzania, Uganda, United Arab Emirates, West Bank/Gaza, Yemen, Zambia, and Zimbabwe** all disputes arising out of this Statement of Limited Warranty or related to its execution, including summary proceedings, will be submitted to the exclusive jurisdiction of the English courts; 3) in **Belgium and Luxembourg**, all disputes arising out of this Statement of Limited Warranty or related to its interpretation or its execution, the law, and the courts of the capital city, of the country of your registered office and/or commercial site location only are competent; 4) in **France, Algeria, Benin, Burkina Faso, Cameroon, Cape Verde, Central African Republic, Chad, Comoros, Congo Republic, Djibouti, Democratic Republic of Congo, Equatorial Guinea, French Guiana, French Polynesia, Gabon, Gambia, Guinea, Guinea-Bissau, Ivory Coast, Lebanon, Madagascar, Mali, Mauritania, Mauritius, Mayotte, Morocco, New Caledonia, Niger, Reunion, Senegal, Seychelles, Togo, Tunisia, Vanuatu, and Wallis & Futuna** all disputes arising out of this Statement of Limited Warranty or related to its violation or execution, including summary proceedings, will be settled exclusively by the Commercial Court of Paris; 5) in **Russia**, all disputes arising out of or in relation to the interpretation, the violation, the termination, the nullity of the execution of this Statement of Limited Warranty shall be settled by Arbitration Court of Moscow; 6) in **South Africa, Namibia, Lesotho and Swaziland**, both of us agree to submit all disputes relating to this Statement of Limited Warranty to the jurisdiction of the High Court in Johannesburg; 7) in **Turkey** all disputes arising out of or in connection with this Statement of Limited Warranty shall be resolved by the Istanbul Central (Sultanahmet) Courts and Execution Directorates of Istanbul, the Republic of Turkey; 8) in each of the following specified countries, any legal claim arising out of this Statement of Limited Warranty will be brought before, and settled exclusively by, the competent court of a) Athens for **Greece**, b) Tel Aviv-Jaffa for **Israel**, c) Milan for **Italy**, d) Lisbon for **Portugal**,

and e) Madrid for **Spain**; and 9) **in the United Kingdom**, both of us agree to submit all disputes relating to this Statement of Limited Warranty to the jurisdiction of the English courts.

Arbitration: *The following is added under this heading:*

In Albania, Armenia, Azerbaijan, Belarus, Bosnia-Herzegovina, Bulgaria, Croatia, Georgia, Hungary, Kazakhstan, Kyrgyzstan, FYR Macedonia, Moldova, Poland, Romania, Russia, Slovakia, Slovenia, Tajikistan, Turkmenistan, Ukraine, Uzbekistan, and FR Yugoslavia all disputes arising out of this Statement of Limited Warranty or related to its violation, termination or nullity will be finally settled under the Rules of Arbitration and Conciliation of the International Arbitral Center of the Federal Economic Chamber in Vienna (Vienna Rules) by three arbitrators appointed in accordance with these rules. The arbitration will be held in Vienna, Austria, and the official language of the proceedings will be English. The decision of the arbitrators will be final and binding upon both parties. Therefore, pursuant to paragraph 598 (2) of the Austrian Code of Civil Procedure, the parties expressly waive the application of paragraph 595 (1) figure 7 of the Code. IBM may, however, institute proceedings in a competent court in the country of installation. **In Estonia, Latvia and Lithuania** all disputes arising in connection with this Statement of Limited Warranty will be finally settled in arbitration that will be held in Helsinki, Finland in accordance with the arbitration laws of Finland then in effect. Each party will appoint one arbitrator. The arbitrators will then jointly appoint the chairman. If arbitrators cannot agree on the chairman, then the Central Chamber of Commerce in Helsinki will appoint the chairman.

EUROPEAN UNION (EU)

THE FOLLOWING TERMS APPLY TO ALL EU COUNTRIES:

The warranty for Machines acquired in EU countries is valid and applicable in all EU countries provided the Machines have been announced and made available in such countries.

How to Obtain Warranty Service: *The following is added to this section:*

To obtain warranty service from IBM in EU countries, see the telephone listing in Part 3 - Warranty Information.

You may contact IBM at the following address:

IBM Warranty & Service Quality Dept.

PO Box 30

Spango Valley

Greenock

Scotland PA16 0AH

CONSUMERS

Consumers have legal rights under applicable national legislation governing the sale of consumer goods. Such rights are not affected by the warranties provided in this Statement of Limited Warranty.

AUSTRIA, DENMARK, FINLAND, GREECE, ITALY, NETHERLANDS, NORWAY, PORTUGAL, SPAIN, SWEDEN AND SWITZERLAND

Limitation of Liability: *The following replaces the terms of this section in its entirety:*

Except as otherwise provided by mandatory law:

1. IBM's liability for any damages and losses that may arise as a consequence of the fulfillment of its obligations under or in connection with this Statement of Limited Warranty or due to any other cause related to this Statement of Limited Warranty is limited to the compensation of only those damages and losses proved and actually arising as an immediate and direct consequence of the non-fulfillment of such obligations (if IBM is at fault) or of such cause, for a maximum amount equal to the charges you paid for the Machine. For purposes of this item, the term "Machine" includes Machine Code and Licensed Internal Code ("LIC").

The above limitation shall not apply to damages for bodily injuries (including death) and damages to real property and tangible personal property for which IBM is legally liable.

2. **UNDER NO CIRCUMSTANCES IS IBM, ITS SUPPLIERS OR RESELLERS LIABLE FOR ANY OF THE FOLLOWING, EVEN IF INFORMED OF THEIR POSSIBILITY: 1) LOSS OF, OR DAMAGE TO, DATA; 2) INCIDENTAL OR INDIRECT DAMAGES, OR FOR ANY ECONOMIC CONSEQUENTIAL DAMAGES; 3) LOST PROFITS, EVEN IF THEY ARISE AS AN IMMEDIATE CONSEQUENCE OF THE EVENT THAT GENERATED THE DAMAGES; OR 4) LOSS OF BUSINESS, REVENUE, GOODWILL, OR ANTICIPATED SAVINGS.**

FRANCE AND BELGIUM

Limitation of Liability: *The following replaces the terms of this section in its entirety:*

Except as otherwise provided by mandatory law:

1. IBM's liability for any damages and losses that may arise as a consequence of the fulfillment of its obligations under or in connection with this Statement of Limited Warranty is limited to the compensation of only those damages and losses proved and actually arising as an immediate and direct consequence of the non-fulfillment of such obligations (if IBM is at fault), for a maximum amount equal to the charges you paid for the Machine that has caused the damages. For purposes of this item, the term "Machine" includes Machine Code and Licensed Internal Code ("LIC").

The above limitation shall not apply to damages for bodily injuries (including death) and damages to real property and tangible personal property for which IBM is legally liable.

2. **UNDER NO CIRCUMSTANCES IS IBM, ITS SUPPLIERS OR RESELLERS LIABLE FOR ANY OF THE FOLLOWING, EVEN IF INFORMED OF THEIR POSSIBILITY: 1) LOSS OF, OR DAMAGE TO, DATA; 2) INCIDENTAL OR INDIRECT DAMAGES, OR FOR ANY ECONOMIC CONSEQUENTIAL DAMAGES; 3) LOST PROFITS, EVEN IF THEY ARISE AS AN IMMEDIATE CONSEQUENCE OF THE EVENT THAT GENERATED THE DAMAGES; OR 4) LOSS OF BUSINESS, REVENUE, GOODWILL, OR ANTICIPATED SAVINGS.**

THE FOLLOWING TERMS APPLY TO THE COUNTRY SPECIFIED:

AUSTRIA

The provisions of this Statement of Limited Warranty replace any applicable statutory warranties.

What this Warranty Covers: *The following replaces the first sentence of the first paragraph of this section:*

The warranty for an IBM Machine covers the functionality of the Machine for its normal use and the Machine's conformity to its Specifications.

The following paragraphs are added to this section:

The limitation period for consumers in action for breach of warranty is the statutory period as a minimum. In case IBM or your reseller is unable to repair an IBM Machine, you can alternatively ask for a partial refund as far as justified by the reduced value of the unrepaired Machine or ask for a cancellation of the respective agreement for such Machine and get your money refunded.

The second paragraph does not apply.

What IBM Will Do to Correct Problems: *The following is added to this section:*

During the warranty period, IBM will reimburse you for the transportation charges for the delivery of the failing Machine to IBM.

Limitation of Liability: *The following paragraph is added to this section:*

The limitations and exclusions specified in the Statement of Limited Warranty will not apply to damages caused by IBM with fraud or gross negligence and for express warranty.

The following sentence is added to the end of item 2:

IBM's liability under this item is limited to the violation of essential contractual terms in cases of ordinary negligence.

EGYPT

Limitation of Liability: *The following replaces item 2 in this section:*

as to any other actual direct damages, IBM's liability will be limited to the total amount you paid for the Machine that is the subject of the claim. For purposes of this item, the term "Machine" includes Machine Code and Licensed Internal Code ("LIC").

Applicability of suppliers and resellers (unchanged).

FRANCE

Limitation of Liability: *The following replaces the second sentence of the first paragraph of this section:*

In such instances, regardless of the basis on which you are entitled to claim damages from IBM, IBM is liable for no more than: (items 1 and 2 unchanged).

GERMANY

What this Warranty Covers: *The following replaces the first sentence of the first paragraph of this section:*

The warranty for an IBM Machine covers the functionality of the Machine for its normal use and the Machine's conformity to its Specifications.

The following paragraphs are added to this section:

The minimum warranty period for Machines is twelve months. In case IBM or your reseller is unable to repair an IBM Machine, you can alternatively ask for a partial refund as far as justified by the reduced value of the unrepaired Machine or ask for a cancellation of the respective agreement for such Machine and get your money refunded.

The second paragraph does not apply.

What IBM Will Do to Correct Problems: *The following is added to this section:*

During the warranty period, transportation for delivery of the failing Machine to IBM will be at IBM's expense.

Limitation of Liability: *The following paragraph is added to this section:*

The limitations and exclusions specified in the Statement of Limited Warranty will not apply to damages caused by IBM with fraud or gross negligence and for express warranty.

The following sentence is added to the end of item 2:

IBM's liability under this item is limited to the violation of essential contractual terms in cases of ordinary negligence.

HUNGARY

Limitation of Liability: *The following is added at the end of this section:*

The limitation and exclusion specified herein shall not apply to liability for a breach of contract damaging life, physical well-being, or health that has been caused intentionally, by gross negligence, or by a criminal act. The parties accept the limitations of liability as valid provisions and state that the Section 314.(2) of the Hungarian Civil Code applies as the acquisition price as well as other advantages arising out of the present Statement of Limited Warranty balance this limitation of liability.

IRELAND

What this Warranty Covers: *The following is added to this section:*

Except as expressly provided in these terms and conditions, all statutory conditions, including all warranties implied, but without prejudice to the generality of the foregoing all warranties implied by the Sale of Goods Act 1893 or the Sale of Goods and Supply of Services Act 1980 are hereby excluded.

Limitation of Liability: *The following replaces the terms of section in its entirety:*

For the purposes of this section, a "Default" means any act, statement, omission, or negligence on the part of IBM in connection with, or in relation to, the subject matter of this

Statement of Limited Warranty in respect of which IBM is legally liable to you, whether in contract or tort. A number of Defaults which together result in, or contribute to, substantially the same loss or damage will be treated as one Default occurring on the date of occurrence of the last such Default. Circumstances may arise where, because of a Default, you are entitled to recover damages from IBM. This section sets out the extent of IBM's liability and your sole remedy.

1. IBM will accept unlimited liability for death or personal injury caused by the negligence of IBM
2. Subject always to the **Items for Which IBM is Not Liable** below, IBM will accept unlimited liability for physical damage to your tangible property resulting from the negligence of IBM.
3. Except as provided in items 1 and 2 above, IBM's entire liability for actual damages for any one Default will not in any event exceed the greater of 1) EUR 125,000, or 2) 125% of the amount you paid for the Machine directly relating to the Default.

Items for Which IBM is Not Liable

Save with respect to any liability referred to in item 1 above, under no circumstances is IBM, its suppliers or resellers liable for any of the following, even if IBM or they were informed of the possibility of such losses:

1. loss of, or damage to, data;
2. special, indirect, or consequential loss; or
3. loss of profits, business, revenue, goodwill, or anticipated savings.

SLOVAKIA

Limitation of Liability: *The following is added to the end of the last paragraph:*

The limitations apply to the extent they are not prohibited under §§ 373-386 of the Slovak Commercial Code.

SOUTH AFRICA, NAMIBIA, BOTSWANA, LESOTHO AND SWAZILAND

Limitation of Liability: *The following is added to this section:*

IBM's entire liability to you for actual damages arising in all situations involving nonperformance by IBM in respect of the subject matter of this Statement of Warranty will be limited to the charge paid by you for the individual Machine that is the subject of your claim from IBM.

UNITED KINGDOM

Limitation of Liability: *The following replaces the terms of this section in its entirety:*

For the purposes of this section, a "Default" means any act, statement, omission, or negligence on the part of IBM in connection with, or in relation to, the subject matter of this Statement of Limited Warranty in respect of which IBM is legally liable to you, whether in contract or tort. A number of Defaults which together result in, or contribute to, substantially the same loss or damage will be treated as one Default. Circumstances may arise where, because of a Default, you are entitled to recover damages from IBM. This section sets out the extent of IBM's liability and your sole remedy.

1. IBM will accept unlimited liability for:
 - a. death or personal injury caused by the negligence of IBM; and
 - b. any breach of its obligations implied by Section 12 of the Sale of Goods Act 1979 or Section 2 of the Supply of Goods and Services Act 1982, or any statutory modification or re-enactment of either such Section.
2. IBM will accept unlimited liability, subject always to the **Items for Which IBM is Not Liable** below, for physical damage to your tangible property resulting from the negligence of IBM.

3. IBM's entire liability for actual damages for any one Default will not in any event, except as provided in items 1 and 2 above, exceed the greater of 1) Pounds Sterling 75,000, or 2) 125% of the total purchase price payable or the charges for the Machine directly relating to the Default.

These limits also apply to IBM's suppliers and resellers. They state the maximum for which IBM and such suppliers and resellers are collectively responsible.

Items for Which IBM is Not Liable

Save with respect to any liability referred to in item 1 above, under no circumstances is IBM or any of its suppliers or resellers liable for any of the following, even if IBM or they were informed of the possibility of such losses:

1. loss of, or damage to, data;
2. special, indirect, or consequential loss; or
3. loss of profits, business, revenue, goodwill, or anticipated savings.

Part 3 - Warranty Information

This Part 3 provides information regarding the warranty applicable to your Machine, including the warranty period and type of warranty service IBM provides.

Warranty Period

The warranty period may vary by country or region and is specified in the table below.

NOTE: "Region" means either Hong Kong or Macau Special Administrative Region of China.

C400 PROJECTOR

Country or Region of Purchase	Warranty Period	Type of Warranty Service
Worldwide	3 years	7

C400 PROJECTOR LAMP

Country or Region of Purchase	Warranty Period	Type of Warranty Service
Worldwide	3 months	7

A warranty period of 3 years on parts and 3 years on labor means that IBM provides warranty service without charge for parts and labor during the 3 year warranty period.

A warranty period of 3 months on parts and 3 months on labor means that IBM provides warranty service without charge for parts and labor during the 3 month warranty period.

Types of Warranty Service

If required, IBM provides repair or exchange service depending on the type of warranty service specified for your Machine in the above table and as described below. Warranty service may be provided by your reseller if approved by IBM to perform warranty service. Scheduling of service will depend upon the time of your call and is subject to parts availability. Service levels are response time objectives and are not guaranteed. The specified level of warranty service may not be available in all worldwide locations, additional charges may apply outside IBM's normal service area, contact your local IBM representative or your reseller for country and location specific information.

1. **Customer Replaceable Unit ("CRU") Service**

IBM provides replacement CRUs to you for you to install. CRU information and replacement instructions are shipped with your Machine and are available from IBM at any time on your request. Installation of Tier 1 CRUs is your responsibility. If IBM installs a Tier 1 CRU at your request, you will be charged for the installation. You may install a Tier 2 CRU yourself or request IBM to install it, at no additional charge, under the type of warranty service designated for your Machine. IBM specifies in the materials shipped with a replacement CRU whether a defective CRU must be returned to IBM. When return is required, 1) return instructions and a container are shipped with the replacement CRU, and 2) you may be charged for the replacement CRU if IBM does not receive the defective CRU within 30 days of your receipt of the replacement.

2. On-site Service

IBM or your reseller will either repair or exchange the failing Machine at your location and verify its operation. You must provide suitable working area to allow disassembly and reassembly of the IBM Machine. The area must be clean, well lit and suitable for the purpose. For some Machines, certain repairs may require sending the Machine to an IBM service center.

3. Courier or Depot Service *

You will disconnect the failing Machine for collection arranged by IBM. IBM will provide you with a shipping container for you to return your Machine to a designated service center. A courier will pick up your Machine and deliver it to the designated service center. Following its repair or exchange, IBM will arrange the return delivery of the Machine to your location. You are responsible for its installation and verification.

4. Customer Carry-In or Mail-In Service

You will deliver or mail as IBM specifies (prepaid unless IBM specifies otherwise) the failing Machine suitably packaged to a location IBM designates. After IBM has repaired or exchanged the Machine, IBM will make it available for your collection or, for Mail-in Service, IBM will return it to you at IBM's expense, unless IBM specifies otherwise. You are responsible for the subsequent installation and verification of the Machine.

5. CRU and On-site Service

This type of Warranty Service is a combination of Type 1 and Type 2 (see above).

6. CRU and Courier or Depot Service

This type of Warranty Service is a combination of Type 1 and Type 3 (see above).

7. CRU and Customer Carry-In or Mail-In Service

This type of Warranty Service is a combination of Type 1 and Type 4 (see above).

When a 5, 6 or 7 type of warranty service is listed, IBM will determine which type of warranty service is appropriate for the repair.

* This type of service is called ThinkPad EasyServ or EasyServ in some countries. The IBM Machine Warranty worldwide web site at http://www.ibm.com/servers/support/machine_warranties/ provides a worldwide overview of IBM's Limited Warranty for Machines, a Glossary of IBM definitions, Frequently Asked Questions (FAQs) and Support by Product (Machine) with links to Product Support pages. **The IBM Statement of Limited Warranty is also available on this site in 29 languages.** To obtain warranty service contact IBM or your IBM reseller. In Canada or the United States, call 1-800-IBM-SERV (426-7378). In Canada or the United States, call 1-800-IBM-SERV (426-7378). For other countries, see the telephone numbers below.

Phone numbers are subject to change without notice. For the latest phone number list, go to <http://www.ibm.com/pc/support> and click **Support Phone List**.

Country or Region	Telephone Number	Country or Region	Telephone Number
Africa	+44 (0) 1475 555 055	Japan	Desktop: 0120-887-870 <ul style="list-style-type: none"> Overseas calls: 81-46-266-1084 ThinkPad: 0120-887-874 <ul style="list-style-type: none"> Overseas calls: 81-46-266-1084 IntelliStation and xSeries: 81-46-266-1358 PC Software: 0120-558-695 <ul style="list-style-type: none"> Overseas calls: 81-44-200-8666
Argentina	0800-666-0011	Luxembourg	298-977-5063
Australia	131-426	Malaysia	(60) 3-7727-7800
Austria	01-24592-5901	Mexico	001-866-434-2080
Bolivia	0800-0189	Middle East	+44 (0) 1475 555 055
Belgium	Dutch: 02-210 9820 French: 02-210 9800	Netherlands	020-514 5770
Brazil	55-11-3889-8986	New Zealand	0800-446-149
Canada	English: 1-800-565-3344 French: 1-800-565-3344 In Toronto: 416-383-3344	Nicaragua	255-6658
Chile	800-224-488	Norway	66 81 11 00
China	800-810-1818	Panama	206-6047
China (Hong Kong and S.A.R.)	Home PC: 852-2825-7799 Commercial PC: 852-8205-0333	Peru	0-800-50-866
Colombia	980-912-3021	Philippines	(63) 2-995-2225
Costa Rica	284-3911	Portugal	21-892-7147
Denmark	45 20 82 00	Russia	095-940-2000
Dominican Republic	566-4755 or 566-5161 ext. 8201 Toll Free within the Dominican Republic: 1-200-1929	Singapore	(65) 1-800-840-9911
Ecuador	1-800-426911 (option #4)	Spain	91-714-7983
El Salvador	250-5696	Sweden	08-477 4420

Country or Region	Telephone Number	Country or Region	Telephone Number
Finland	09-459 69 60	Switzerland	058-333-0900
France	02 38 55 74 50	Taiwan	886-2-8723-9799
Germany	07032-1549 201	Thailand	(66) 2-273-4000
Guatemala	335-8490	Turkey	00-800-446-32-041
Honduras	Tegucigalpa & Sand Pedro Sula: 232-4222 San Pedro Sula: 552-2234	United Kingdom	0-1475-555 055
India	1600-44-6666	United States	1-800-IBM-SERV (1-800-426-7378)
Indonesia	(62) 21-523-8535	Uruguay	000-411-005-6649
Ireland	01-815-9202	Venezuela	0-800-100-2011
Italy	01-815-9202	Vietnam	Ho Chi Minh: (84) 8-829-5160 Hanoi: (84) 4-843-6675

Dodatak F. Notices

IBM may not offer the products, services, or features discussed in this document in all countries. Consult your local IBM representative for information on the products and services currently available in your area. Any reference to an IBM product, program, or service is not intended to state or imply that only that IBM product, program, or service may be used. Any functionally equivalent product, program, or service that does not infringe any IBM intellectual property right may be used instead. However, it is the user's responsibility to evaluate and verify the operation of any non-IBM product, program, or service.

IBM may have patents or pending patent applications covering subject matter described in this document. The furnishing of this document does not give you any license to these patents. You can send license inquiries, in writing, to:

*IBM Director of Licensing
IBM Corporation
North Castle Drive
Armonk, NY 10504-1785
U.S.A.*

INTERNATIONAL BUSINESS MACHINES CORPORATION PROVIDES THIS PUBLICATION "AS IS" WITHOUT WARRANTY OF ANY KIND, EITHER EXPRESS OR IMPLIED, INCLUDING, BUT NOT LIMITED TO, THE IMPLIED WARRANTIES OF NON-INFRINGEMENT, MERCHANTABILITY OR FITNESS FOR A PARTICULAR PURPOSE. Some jurisdictions do not allow disclaimer of express or implied warranties in certain transactions, therefore, this statement may not apply to you.

This information could include technical inaccuracies or typographical errors. Changes are periodically made to the information herein; these changes will be incorporated in new editions of the publication. IBM may make improvements and/or changes in the product(s) and/or the program(s) described in this publication at any time without notice.

The products described in this document are not intended for use in implantation or other life support applications where malfunction may result in injury or death to persons. The information contained in this document does not affect or change IBM product specifications or warranties. Nothing in this document shall operate as an express or implied license or indemnity under the intellectual property rights of IBM or third parties. All information contained in this document was obtained in specific environments and is presented as an illustration. The result obtained in other operating environments may vary.

IBM may use or distribute any of the information you supply in any way it believes appropriate without incurring any obligation to you.

Any references in this publication to non-IBM Web sites are provided for convenience only and do not in any manner serve as an endorsement of those Web sites. The materials at those Web sites are not part of the materials for this IBM product, and use of those Web sites is at your own risk.

Any performance data contained herein was determined in a controlled environment. Therefore, the result obtained in other operating environments may vary significantly. Some measurements may have been made on development-level systems and there is no guarantee that these measurements will be the same on generally available systems. Furthermore, some measurements may have been estimated through extrapolation. Actual results may vary. Users of this document should verify the applicable data for their specific environment.

Trademarks

The following terms are trademarks of International Business Machines Corporation in the United States, other countries, or both:

IBM
IBM logo
ThinkPad

Microsoft and Windows are trademarks of Microsoft Corporation in the United States, other countries, or both.

Other company, product, or service names may be trademarks or service marks of others.

Electronic emission notices

IBM C400 PROJECTOR

Federal Communications Commission (FCC) statement

Note: This equipment has been tested and found to comply with the limits for a Class B digital device, pursuant to Part 15 of the FCC Rules. These limits are designed to provide reasonable protection against harmful interference in a residential installation. This equipment generates, uses, and can radiate radio frequency energy and, if not installed and used in accordance with the instructions, may cause harmful interference to radio communications. However, there is no guarantee that interference will not occur in a particular installation. If this equipment does cause harmful interference to radio or television reception, which can be determined by turning the equipment off and on, the user is encouraged to try to correct the interference by one or more of the following measures:

- Reorient or relocate the receiving antenna.
- Increase the separation between the equipment and receiver.
- Connect the equipment into an outlet on a circuit different from that to which the receiver is connected.
- Consult an IBM authorized dealer or service representative for help.

Properly shielded and grounded cables and connectors must be used in order to meet FCC emission limits. Proper cables and connectors are available from IBM authorized dealers. IBM is not responsible for any radio or television interference caused by using other than recommended cables and connectors or by unauthorized changes or modifications to this equipment. Unauthorized changes or modifications could void the user's authority to operate the equipment.

This device complies with Part 15 of the FCC Rules. Operation is subject to the following two conditions: (1) this device may not cause harmful interference, and (2) this device must accept any interference received, including interference that may cause undesired operation.

Responsible party:

International Business Machines Corporation
New Orchard Road
Armonk, NY 10504
Telephone: 1-919-543-2193

FC Tested To Comply
With FCC Standards
FOR HOME OR OFFICE USE

Industry Canada Class B emission compliance statement

This Class B digital apparatus complies with Canadian ICES-003.

Avis de conformité a la réglementation d'Industrie Canada

Cet appareil numérique de la classe B est conforme à la norme NMB-003 du Canada.

Deutsche EMV-Direktive (electromagnetische Verträglichkeit)

Zulassungsbcheinigung laut dem Deutschen Gesetz über die elektromagnetische Verträglichkeit von Geräten (EMVG) vom 30. August 1995 (bzw. der EMC EG Richtlinie 89/336):

Dieses Gerät ist berechtigt in Übereinstimmung mit dem Deutschen EMVG das EG-Konformitätszeichen - CE - zu führen. Verantwortlich für die Konformitätserklärung nach Paragraph 5 des EMVG ist die:

IBM Deutschland Informationssysteme GmbH, 70548 Stuttgart.

Informationen in Hinsicht EMVG Paragraph 3 Abs. (2) 2:

Das Gerät erfüllt die Schutzanforderungen nach EN 55024:1998 und EN 55022:1998 Klasse B.
--

EN 55022 Hinweis:

“Wird dieses Gerät in einer industriellen Umgebung betrieben (wie in EN 55022:B festgelegt), dann kann es dabei eventuell gestört werden. In solch einem FA11 ist der Abstand bzw. die Abschirmung zu der industriellen Störquelle zu vergrößern.”

Anmerkung:

Um die Einhaltung des EMVG sicherzustellen sind die Geräte, wie in den IBM Handbüchern angegeben, zu installieren und zu betreiben.

European Union - emission directive

This product is in conformity with the protection requirements of EU Council Directive 89/336/ECC on the approximation of the laws of the Member States relating to electromagnetic compatibility.

IBM can not accept responsibility for any failure to satisfy the protection requirements resulting from a non-recommended modification of the product, including the fitting of non-IBM option cards.

This product has been tested and found to comply with the limits for Class B Information Technology Equipment according to European Standard EN 55022. The limits for Class B equipment were derived for typical residential environments to provide reasonable protection against interference with licensed communication devices.

Union Européenne - Directive Conformité électromagnétique

Ce produit est conforme aux exigences de protection de la Directive 89/336/EEC du Conseil de l'UE sur le rapprochement des lois des États membres en matière de compatibilité électromagnétique.

IBM ne peut accepter aucune responsabilité pour le manquement aux exigences de protection résultant d'une modification non recommandée du produit, y compris l'installation de cartes autres que les cartes IBM.

Ce produit a été testé et il satisfait les conditions de l'équipement informatique de Classe B en vertu de Standard européen EN 55022. Les conditions pour l'équipement de Classe B ont été définies en fonction d'un contexte résidentiel ordinaire afin de fournir une protection raisonnable contre l'interférence d'appareils de communication autorisés.

Unione Europea - Directiva EMC (Conformidad electromagnética)

Este producto satisface los requisitos de protección del Consejo de la UE, Directiva 89/336/CEE en lo que a la legislación de los Estados Miembros sobre compatibilidad electromagnética se refiere.

IBM no puede aceptar responsabilidad alguna si este producto deja de satisfacer dichos requisitos de protección como resultado de una modificación no recomendada del producto, incluyendo el ajuste de tarjetas de opción que no sean IBM.

Este producto ha sido probado y satisface los límites para Equipos Informáticos Clase B de conformidad con el Estándar Europeo EN 55022. Los límites para los equipos de Clase B se han establecido para entornos residenciales típicos a fin de proporcionar una protección razonable contra las interferencias con dispositivos de comunicación licenciados.

Union Europea - Normativa EMC

Questo prodotto è conforme alle normative di protezione ai sensi della Direttiva del Consiglio dell'Unione Europea 89/336/CEE sull'armonizzazione legislativa degli stati membri in materia di compatibilità elettromagnetica.

IBM non accetta responsabilità alcuna per la mancata conformità alle normative di protezione dovuta a modifiche non consigliate al prodotto, compresa l'installazione di schede e componenti di marca diversa da IBM.

Le prove effettuate sul presente prodotto hanno accertato che esso rientra nei limiti stabiliti per le apparecchiature di informatica Classe B ai sensi della Norma Europea EN 55022. I limiti delle apparecchiature della Classe B sono stati stabiliti al fine di fornire ragionevole protezione da interferenze mediante dispositivi di comunicazione in concessione in ambienti residenziali tipici.

이 기기는 가정용으로 전자파 적합등록을 한 기기로서
주거지역에서는 물론 모든 지역에서 사용할 수 있습니다.

Japanese statement of compliance for products less than or equal to 20 A per phase

高調波ガイドライン適合品



Broj dijela: 73P3195

Tiskano u Hrvatskoj

(1P) P/N: 73P3195

