

IBM® Netfinity® 7600



Installation Guide

NOTE

Before using this information and the product it supports, be sure to read the general information in “Appendix A. Product warranties and notices,” on page 31.

First Edition (March 2000)

© COPYRIGHT INTERNATIONAL BUSINESS MACHINES CORPORATION, 2000. All rights reserved.

Note to U.S. Government Users — Documentation related to restricted rights — Use, duplication or disclosure is subject to restrictions set forth in GSA ADP Schedule Contract with IBM Corp.

Contents

Safety	v
Chapter 1.Introduction	1
Specifications and features	2
Notices used in this book	3
Major components of the Netfinity 7600 server	4
Chapter 2.Installing options	7
Working inside a server with power on	7
Installing adapters.....	7
Installing memory options.....	10
Installing a drive in a hot-swap bay.....	12
Installing a microprocessor	13
Installing a hot-swap power supply.....	14
Cabling the server	16
Chapter 3.Starting the server	17
Controls and indicators	17
Information LED panel.....	20
Chapter 4.Configuring your server	21
Using the ServerGuide CDs.....	21
After installing the NOS	22
Netfinity systems management solutions	22
Chapter 5.Solving problems	23
POST beep code descriptions	23
POST error messages	24
ServerGuide startup problems	26
Troubleshooting chart.....	27

Appendix A. Product warranties and notices	31
Warranty Statements	31
IBM Statement of Limited Warranty for United States, Puerto Rico, and Canada (Part 1 - General Terms) .	31
IBM Statement of Warranty Worldwide except Canada, Puerto Rico, Turkey, United States (Part 1 - General Terms)	34
Part 2 - Worldwide Country-Unique Terms.....	36
Notices.....	40
Edition Notice.....	40
Year 2000 readiness and instructions.....	41
Trademarks	41
Important notes	42
Electronic emission notices	42
Federal Communications Commission (FCC) Statement.....	42
Industry Canada Class A emission compliance statement	43
Australia and New Zealand Class A statement....	43
United Kingdom telecommunications safety requirement.....	43
European community directive conformance statement	43
Taiwan electrical emission statement	44
Japanese Voluntary Control Council for Interference (VCCI) statement	44
Power cords	44
Index	47

Safety

Before installing this product, read the Safety Information book.

مج، يجب قراءة دات السلامة

Antes de instalar este produto, leia o Manual de Informações sobre Segurança.

安装本产品前请先阅读《安全信息》手册。

Prije instalacije ovog proizvoda pročitajte priručnik sa sigurnosnim uputama.

Před instalací tohoto produktu si přečtěte příručku bezpečnostních instrukcí.

Læs hæftet med sikkerhedsforskrifter, før du installerer dette produkt.

Lue Safety Information -kirjanen, ennen kuin asennat tämän tuotteen.

Avant de procéder à l'installation de ce produit, lisez le manuel Safety Information.

Vor Beginn der Installation die Broschüre mit Sicherheitshinweisen lesen.

Πριν εγκαταστήσετε αυτό το προϊόν, διαβάστε το εγχειρίδιο Safety Information.

לפני שתתקינו מוצר זה, קראו את הוראות הבטיחות.

Przed zainstalowaniem tego produktu należy przeczytać broszurę Informacje Dotyczące Bezpieczeństwa.

Prima di installare questo prodotto, leggere l'opuscolo contenente le informazioni sulla sicurezza.

本製品を導入する前に、安全情報資料を御読みください。

이 제품을 설치하기 전에, 안전 정보 책자를 읽어보십시오.

Пред да го инсталирате овој производ прочитајте ја книгата со безбедносни информации.

Lees voordat u dit product installeert eerst het boekje met veiligheidsvoorschriften.

Les heftet om sikkerhetsinformasjon (Safety Information) før du installerer dette produktet.

Prije instalacije ovog proizvoda pročitajte priručnik sa sigurnosnim uputama.

Antes de instalar este produto, leia o folheto Informações sobre Segurança.

Перед установкой продукта прочтите брошюру по технике безопасности (Safety Information).

Pred inštaláciou tohto produktu si pre ítajte Informa nú brožúrku o bezpe nosti.

Preden namestite ta izdelek, preberite knjižico Varnostne informacije.

Antes de instalar este producto, lea la Información de Seguridad.

Läs säkerhetsinformationen innan du installerar den här produkten.

在安裝本產品之前，也請先閱讀「安全性資訊」小冊子。

Installálás el tt olvassa el a Biztonsági el írások kézikönyvét !

Statement 1



Danger

Electrical current from power, telephone, and communication cables is hazardous.

To avoid a shock hazard:

- **Do not connect or disconnect any cables or perform installation, maintenance, or reconfiguration of this product during an electrical storm.**
- **Connect all power cords to a properly wired and grounded electrical outlet.**
- **Connect to properly wired outlets any equipment that will be attached to this product.**
- **When possible, use one hand only to connect or disconnect signal cables.**
- **Never turn on any equipment when there is evidence of fire, water, or structural damage.**
- **Disconnect the attached power cords, telecommunications systems, networks, and modems before you open the device covers, unless instructed otherwise in the installation and configuration procedures.**
- **Connect and disconnect cables as described in the following table when installing, moving, or opening covers on this product or attached devices.**

To connect:

1. Turn everything OFF.
2. First, attach all cables to devices.
3. Attach signal cables to connectors.
4. Attach power cords to outlet.
5. Turn device ON.

To disconnect:

1. Turn everything OFF.
2. First, remove power cords from outlet.
3. Remove signal cables from connectors.
4. Remove all cables from devices.

Statement 2

CAUTION:



When replacing the lithium battery, use only IBM Part Number 33F8354 or an equivalent type battery recommended by the manufacturer. If your system has a module containing a lithium battery, replace it only with the same module type made by the same manufacturer. The battery contains lithium and can explode if not properly used, handled, or disposed of.

Do not:

- Throw or immerse into water.
- Heat to more than 100 C (212 F)
- Repair or disassemble

Dispose of the battery as required by local ordinances or regulations.

Statement 3



CAUTION:

When laser products (such as CD-ROMs, DVD drives, fiber optic devices, or transmitters) are installed, note the following:

- Do not remove the covers. Removing the covers of the laser product could result in exposure to hazardous laser radiation. There are no serviceable parts inside the device.
- Use of controls or adjustments or performance of procedures other than those specified herein might result in hazardous radiation exposure.



Danger

Some laser products contain an embedded Class 3A or Class 3B laser diode. Note the following. Laser radiation when open. Do not stare into the beam, do not view directly with optical instruments, and avoid direct exposure to the beam.

Statement 4

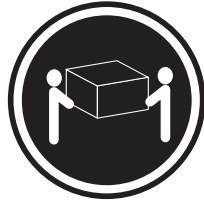

≥18 kg (37 lbs)



≥32 kg (70.5 lbs)

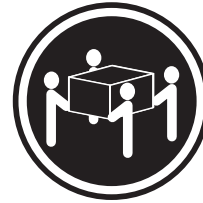

≥55 kg (121.2 lbs)

CAUTION:
Use safe practices when lifting.

Statement 5

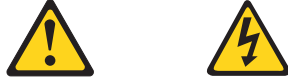

CAUTION:

The power control button on the device and the power supply do not turn off the electrical current supplied to the device. The device also might have more than one power cord. To remove all electrical current from the device, ensure that all power cords are disconnected from the power source.

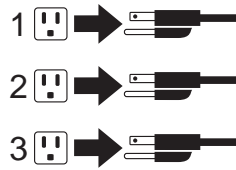

Chapter 1. Introduction

Thank you for purchasing an IBM® Netfinity® 7600 server. This *Installation Guide* provides the information needed to:

- Set up and cable your server
- Start and configure your server
- Install your network operating system (NOS)

Packaged with this *Installation Guide* are software CDs that help you configure hardware, install device drivers, and install the network operating system (NOS).

Also included is an *IBM Netfinity Documentation* CD that provides detailed information about this server.

Your server comes with a three-year limited warranty and 90-Day IBM Start Up Support. If you have access to the World Wide Web, you can obtain up-to-date information about your server model and other IBM server products at the following World Wide Web address:

<http://www.ibm.com/pc/us/netfinity/>

Refer to the *Rack Installation Instructions* for complete details on rack installation and removal instructions.

Record your product information in this table.

Product name	_____
Machine type	_____
Model number	_____
Serial number	_____

Specifications and features

The following table provides a summary of the features and specifications for your Netfinity 7600 server.

<p>Microprocessor:</p> <ul style="list-style-type: none"> • Intel® Pentium®III Xeon™ • 32 KB of level-1 cache • 1 MB of level-2 cache (min) • Expandable to four microprocessors <p>Memory:</p> <ul style="list-style-type: none"> • Maximum: 16 GB • Type: ECC, SDRAM, Registered DIMMs • Slots: 4-way interleaved, 16 slots <p>Drives standard:</p> <ul style="list-style-type: none"> • Diskette: 1.44 MB • CD-ROM: 40X IDE <p>Expansion bays:</p> <ul style="list-style-type: none"> • Hot-swap: 10 slim-high or 7 half high • Non-hot-swap: Two 5.25-inch <p>PCI expansion slots:</p> <ul style="list-style-type: none"> • Four 33 MHz 64-bit • Two 66 MHz 64-bit <p>Hot-swap power supplies:</p> <p>250 Watt (115-230 V ac)</p> <ul style="list-style-type: none"> • Minimum: Three • Maximum: Four <p>Redundant cooling:</p> <ul style="list-style-type: none"> • Four hot-swap fan assemblies <p>Video:</p> <ul style="list-style-type: none"> • S3 video controller • Compatible with SVGA and VGA • 4 MB video memory 	<p>Size</p> <ul style="list-style-type: none"> • Height: 356 mm (14 in.) (8U) • Depth: 650 mm (25.6 in.) • Width: 440 mm (17.3 in.) • Weight: 34.4 kg (76 lb.) to 61 kg (134 lb.) depending upon configuration <p>Integrated functions:</p> <ul style="list-style-type: none"> • Netfinity Advanced System Management processor • IBM ServeRAID controller (three channels) • Dual channel Ultra2 (LVD) SCSI controller, one external port, one internal port • One 10BASE-T/100BASE-TX AMD Ethernet controller • Two serial ports • One parallel port • Two universal serial bus ports • Keyboard port • Mouse port • Video port <p>Acoustical noise emissions:</p> <ul style="list-style-type: none"> • Sound power, idling: 6.3 bel maximum • Sound power, operating: 6.3 bel maximum • Sound pressure, operating: 48 dBa maximum 	<p>Environment:</p> <ul style="list-style-type: none"> • Air temperature: <ul style="list-style-type: none"> — Server on: 10° to 35° C (50° to 95° F). Altitude: 0 to 914 m (3000 ft.) — Server on: 10° to 32° C (50° to 89.6° F). Altitude: 914 m (3000 ft.) to 2133 m (7000 ft.) — Server off: 10° to 43° C (50° to 110° F). Maximum altitude: 2133 m (7000 ft.) • Humidity: <ul style="list-style-type: none"> — Server on: 8% to 80% — Server off: 8% to 80% <p>Heat output:</p> <p>Approximate heat output in British Thermal Units (BTU) per hour</p> <ul style="list-style-type: none"> • Minimum configuration: 1023.9 BTU • Maximum configuration: 2764.6 BTU <p>Electrical input:</p> <ul style="list-style-type: none"> • Sine-wave input (50-60 Hz) required • Input voltage low range: <ul style="list-style-type: none"> — Minimum: 90 V ac — Maximum: 137 V ac • Input voltage high range: <ul style="list-style-type: none"> — Minimum: 180 V ac — Maximum: 265 V ac • Input kilovolt-amperes (kVA) approximately: <ul style="list-style-type: none"> — Minimum: 0.08 kVA — Maximum: 0.52 kVA
--	--	--

Table 1. Features and specifications

Notices used in this book

This information product contains notices that relate to a specific topic. The Caution and Danger notices also appear in the multilingual safety booklet that came with your Netfinity product. Each notice is numbered for easy reference to the corresponding notices in the safety booklet.

The notice definitions are as follows:

- **Notes:** These notices provide important tips, guidance, or advice.
- **Attention:** These notices indicate possible damage to programs, devices, or data. An attention notice is placed just before the instruction or situation in which damage could occur.
- **Caution:** These notices indicate situations that can be potentially hazardous to you. A caution notice is placed just before descriptions of potentially hazardous procedure steps or situations.
- **Danger:** These notices indicate situations that can be potentially lethal or extremely hazardous to you. A danger notice is placed just before descriptions of potentially lethal or extremely hazardous procedure steps or situations.

Major components of the Netfinity 7600 server

The orange color on components and labels in your server identifies hot-swap or hot-plug components. This means that you can install or remove the components while the system is running, provided that your system is configured to support this function. For complete information about installing or removing a hot-swap or hot-plug component, see the information provided in the procedures in this document.

The blue color on components and labels indicates touch points where a component can be gripped, a latch moved, and so on.

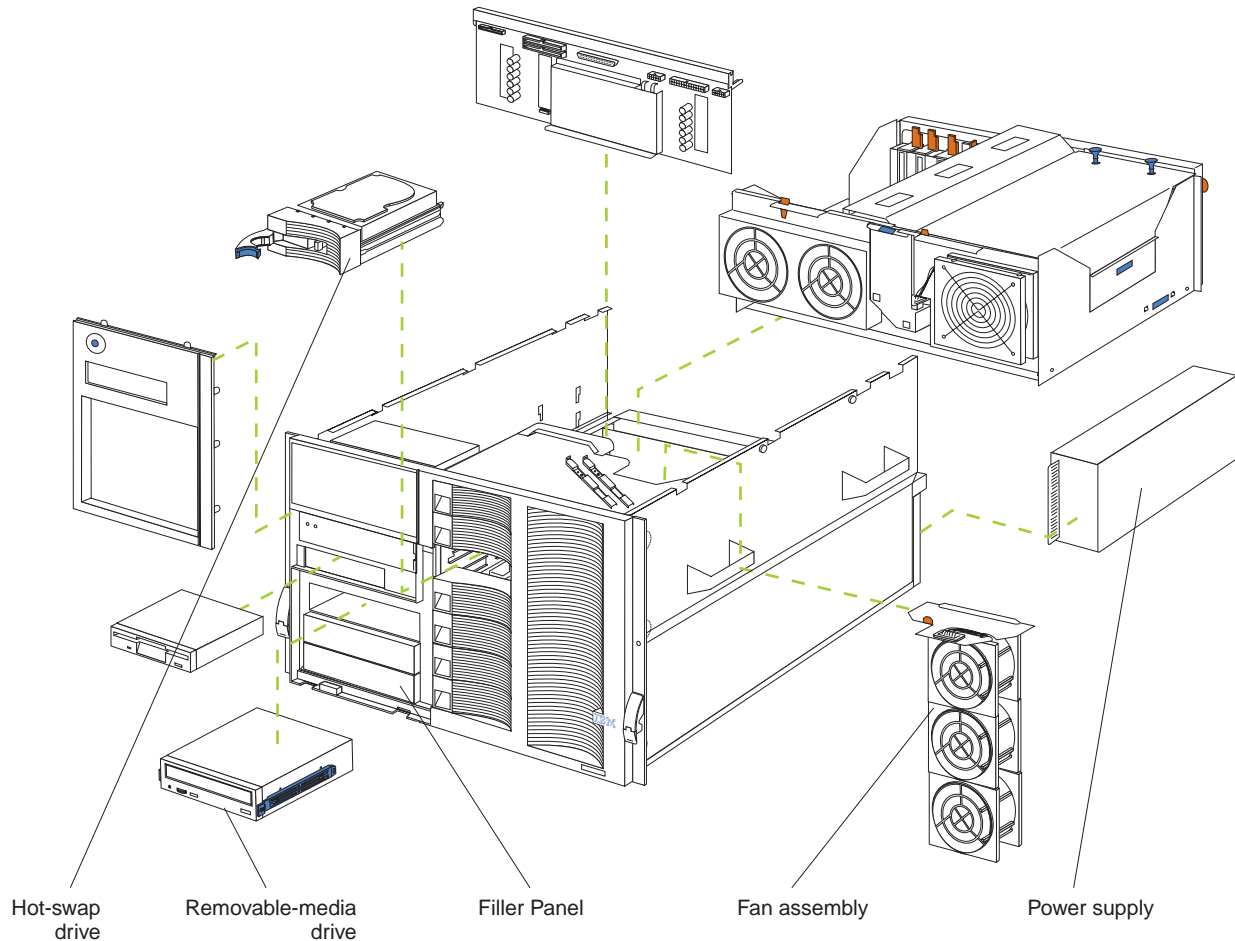

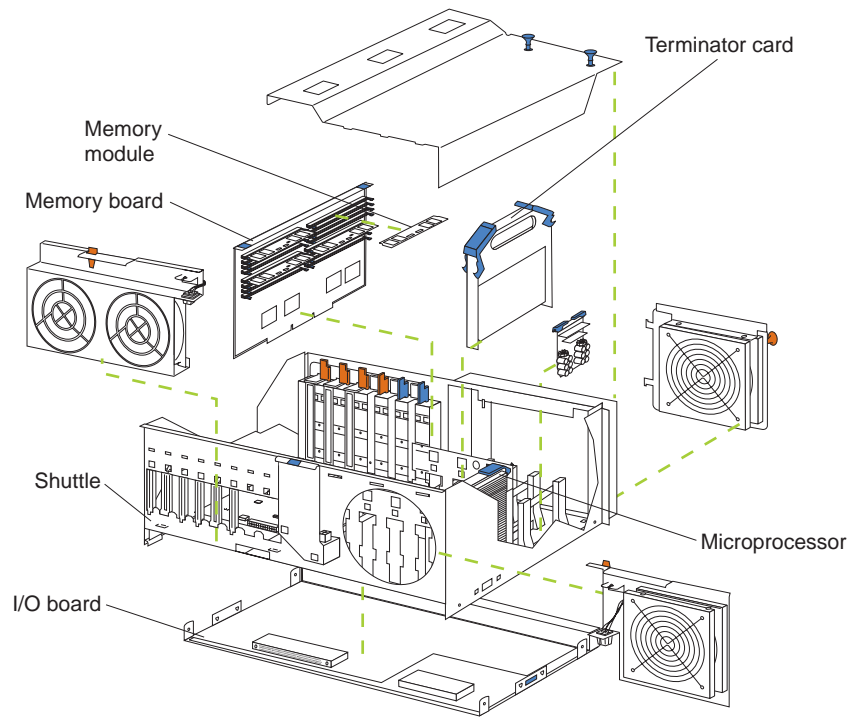

Chapter 2. Installing options

This chapter provides the basic information needed to install hardware options in your server. This section is for all users, but is written with the experienced user in mind. If you need more detailed installation information, see the *User's Reference* on the *IBM Netfinity Documentation CD*.

Working inside a server with power on

Your server supports hot plug, hot add, and hot swap devices and is designed to operate safely while turned on with the cover removed. Follow these guidelines when you work inside a server that is turned on:

- Avoid loose-fitting clothing on your forearms. Button long-sleeved shirts before working inside the server; do not wear cufflinks while you are working inside the server.
- Do not allow your necktie or scarf to hang inside the server.
- Remove jewelry, such as bracelets, necklaces, rings, and loose-fitting wrist watches.
- Remove items from your shirt pocket (such as pens or pencils) that could fall into the server as you lean over it.
- Take care to avoid dropping any metallic objects, such as paper clips, hair pins, or screws, into the server.

Installing adapters

This section describes how to install hot-plug PCI adapters. Before you continue with the adapter-installation procedure, review the following:

- Slots 1 and 2 support 3.3 V and universal non-hot-plug PCI adapters only.
- Slots 3–6 support 5.0V and universal PCI adapters.
Note: Universal PCI adapters support both 3.3V and 5.0V operation.
- The system scans PCI slots 1 through 6 to assign system resources; then, the system starts (boots) the PCI devices in the following order: processor and I/O board devices, slots 1 and 2, and then slots 3 through 6.
- You can install hot-plug PCI adapters in PCI slots 3-6. You can also install non-hot-plug PCI adapters in these slots.

The illustrations in this document might differ slightly from your hardware.

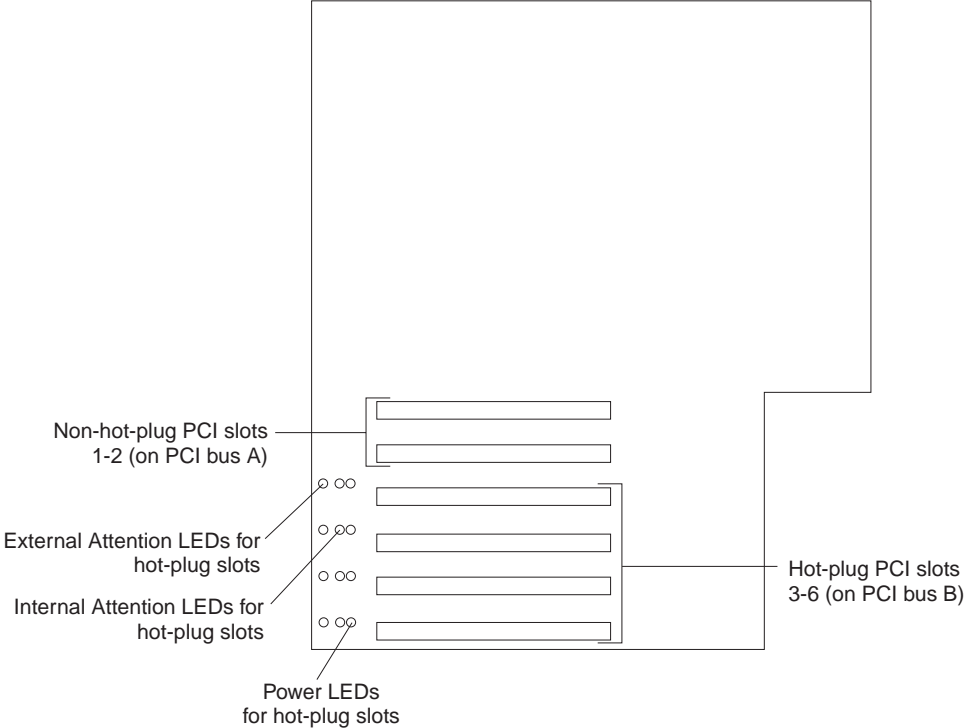

The following illustration shows the installation of a hot-plug adapter.

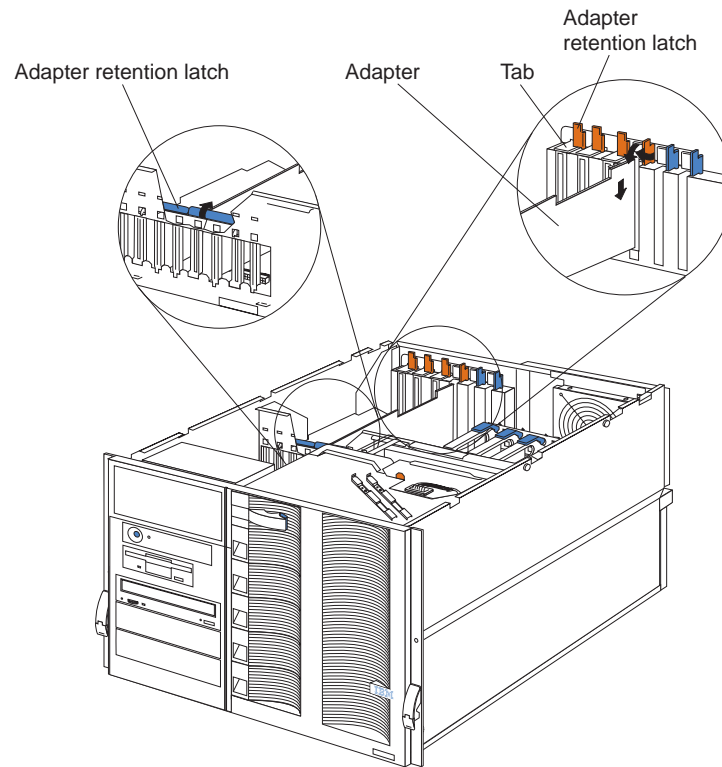

Attention: When you handle Electrostatic Discharge-Sensitive devices (ESD), take precautions to avoid damage from static electricity. For details on handling these devices, refer to the following Web site and use a search term of ESD:

<http://www.ibm.com/>

To install an adapter.

1. Review the information in “Safety” on page v.
2. If you are installing a non-hot-plug adapter, turn off the server and disconnect all cables.
3. Remove the top cover.
4. Select a slot, open the tab and the expansion-slot cover, and remove the expansion-slot cover.
5. Install the adapter in the slot; then, close the tab and adapter retention latch.
6. Install the top cover.
7. If you installed a non-hot-plug adapter, connect all cables and power cords.

Installing memory options

Before you install memory, review the following:

- All the DIMMs installed in each set must be the same size and speed, but all the sets do not have to contain DIMMs of the same size and speed.
- The memory board contains 16 DIMM connectors and supports 4-way memory interleaving.
- Install only 3.3 V, 168-pin, 8-byte, registered DIMMs. Only 100 MHz, 72-bit, registered, synchronous, error correcting code (ECC), SDRAM configuration DIMM memory is supported for the 128 MB, 256 MB, 512 MB and 1 GB DIMMs.
- If you install 4 GB of memory, some of the memory is reserved for system resources. The amount reserved for system resources depends on the configuration of the server.
- If you install 16 GB of memory, the Configuration/Setup Utility will display the memory that is usable by the network operating system. This amount of memory might differ from the amount of memory you have installed.
- Installing or removing DIMMs changes the configuration information in the server. Therefore, after installing or removing a DIMM, you must save the new configuration information using the Configuration/Setup Utility program. See the *User's Reference* on the *IBM Netfinity Publication CD* for more information.
- Install the DIMMs as shown in Table 2.

Set of 4 DIMMs	install DIMMs in these connectors:
First set (shipped as standard)	J1, J5, J9, J13
2nd set	J2, J6, J10, J14
3rd set	J3, J7, J11, J15
4th set	J4, J8, J12, J16

Table 2. DIMM installation order

The illustrations in this document might differ slightly from your hardware.

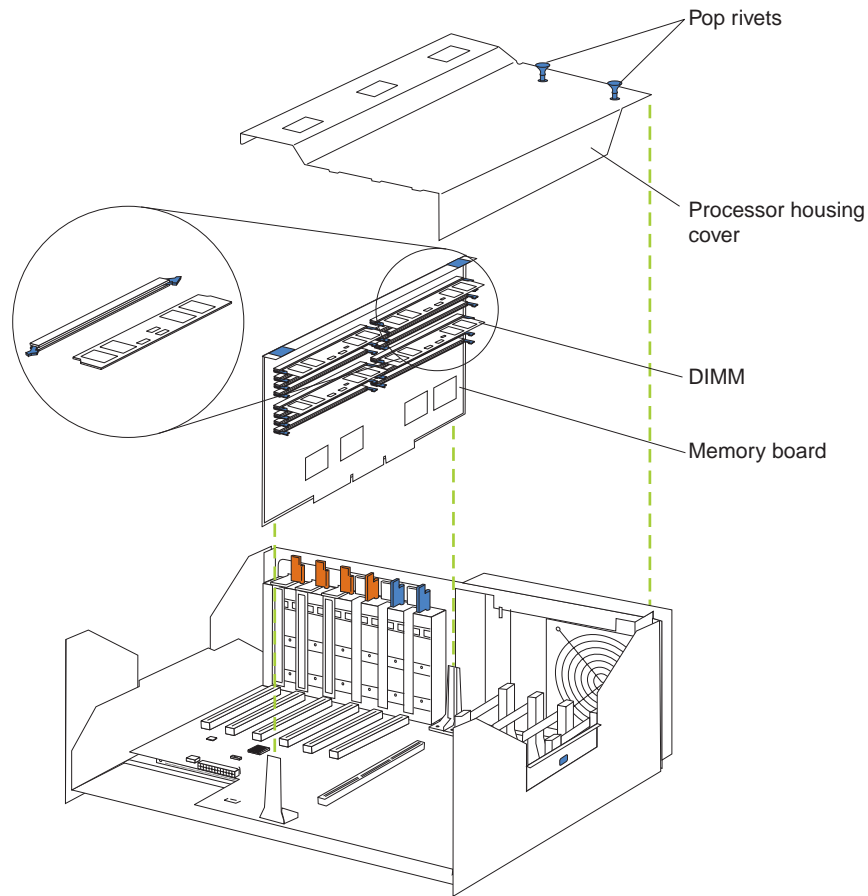

Attention: When you handle Electrostatic Discharge-Sensitive devices (ESD), take precautions to avoid damage from static electricity. For details on handling these devices, refer to the following Web site and use a search term of ESD:

<http://www.ibm.com/>

To install a memory module:

1. Review the information in “Safety” on page v.
2. Turn off the server and remove the power cords.
3. Remove the top cover.
4. Remove the processor housing cover and remove the memory board assembly from the server.
5. Select the connectors in which to install the DIMMs.
6. Install the DIMMs in the connectors.
7. Replace the memory board assembly in the server and replace the processor housing cover.
8. Install the top cover.
9. Connect all cables and power cords.

Installing a drive in a hot-swap bay

Your server supports ten 1-inch (26 mm) slim-high or seven 1.6-inch (42 mm) half-high, 3.5-inch hot-swap hard disk drives in the hot-swap bays.

Note: See the *User's Reference* on the *IBM Netfinity Documentation* CD for information on installing devices in the non-hot-swap bays.

The illustrations in this document might differ slightly from your hardware.

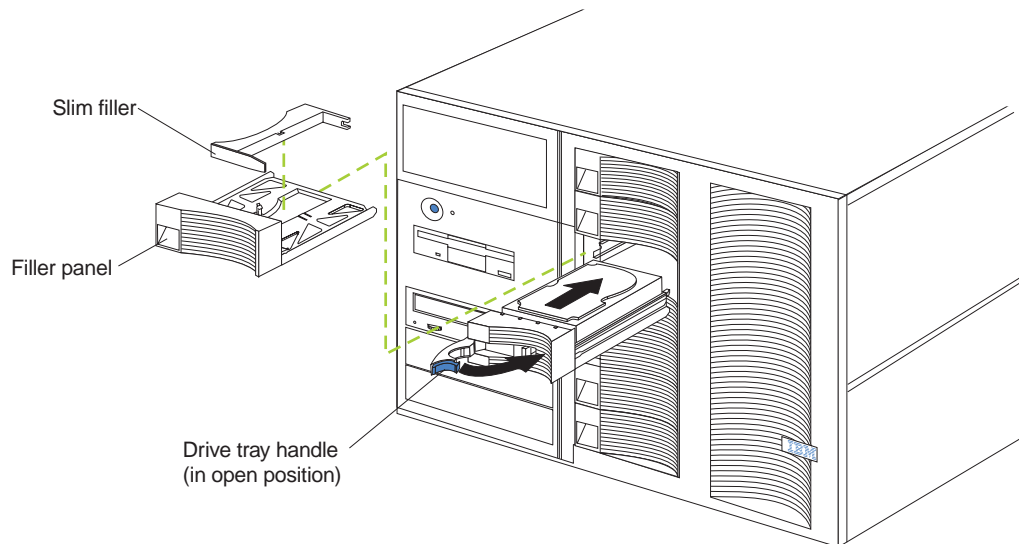

Attention: When you handle Electrostatic Discharge-Sensitive devices (ESD), take precautions to avoid damage from static electricity. For details on handling these devices, refer to the following Web site and use a search term of ESD:

<http://www.ibm.com/>

To install a drive in a hot-swap bay:

1. Review the information in "Safety" on page v.
2. Remove the filler panel.
3. Place the drive handle in the open position and slide the drive into the bay.
4. Close the drive handle.
5. If there is a gap above or below the drive, remove the slim filler from the filler panel and install it above or below the drive.

Installing a microprocessor

Your server comes with one microprocessor installed in connector J2. This is the startup (boot) microprocessor. A microprocessor installed in connector J3 is microprocessor 2; a microprocessor installed in connector J4 is microprocessor 3; a microprocessor installed in connector J5 is processor 4. If more than one microprocessor is installed, the highest numbered microprocessor is the one the server will start from. The lower numbered microprocessors are used as application microprocessors.

The illustrations in this document might differ slightly from your hardware.

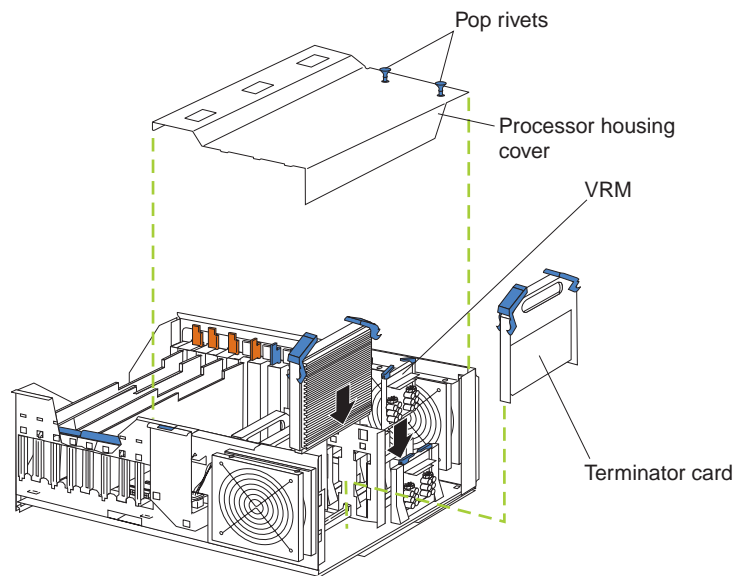

Attention: When you handle Electrostatic Discharge-Sensitive devices (ESD), take precautions to avoid damage from static electricity. For details on handling these devices, refer to the following Web site and use a search term of ESD:

<http://www.ibm.com/>

To install an additional microprocessor kit:

1. Review the information in “Safety” on page v.
2. Turn off the server and remove the power cords.
3. Remove the top cover.
4. Remove the processor housing cover.
5. Remove the terminator card from the connector.

6. Install the microprocessor.

Note: Each microprocessor connector must contain either a terminator card or a microprocessor.

7. Install the voltage regulator module (VRM).
8. Install the processor housing cover.
9. Install the top cover.
10. Cable the server and connect all power cords.

Installing a hot-swap power supply

If you install or remove a power supply, observe the following precautions:

Statement 8



CAUTION:

Never remove the cover on a power supply or any part that has the following label attached.



Hazardous voltage, current, and energy levels are present inside any component that has this label attached. There are no serviceable parts inside these components. If you suspect a problem with one of these parts, contact a service technician.

The illustrations in this document might differ slightly from your hardware.

Attention: When you handle Electrostatic Discharge-Sensitive devices (ESD), take precautions to avoid damage from static electricity. For details on handling these devices, refer to the following Web site and use a search term of ESD:

<http://www.ibm.com/>

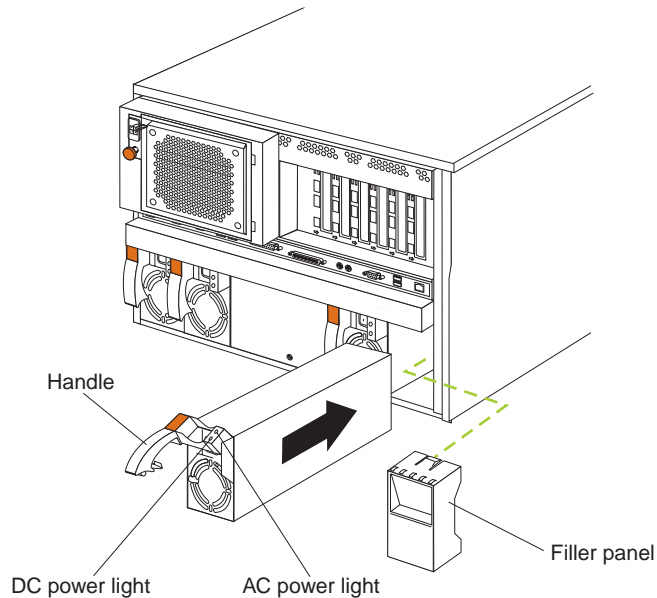

To install an additional power supply:

1. Review the information in “Safety” on page v.
2. Remove the filler panel.
3. Place the handle on the power supply in the open position.
4. Slide the power supply into the chassis and press the handle to the closed position.
5. Plug the power cord into the power supply; then, into a properly grounded electrical outlet.
6. Verify that the DC Power light and the AC Power light on the power supply are lit, indicating that the power supply is operating properly.

Statement 6



CAUTION:

If you install a strain-relief bracket option over the end of the power cord that is connected to the device, you must connect the other end of the power cord to an easily accessible power source

Cabling the server

Refer to the following illustration for the location of the input and output connectors on your server.

The illustrations in this document might differ slightly from your hardware.

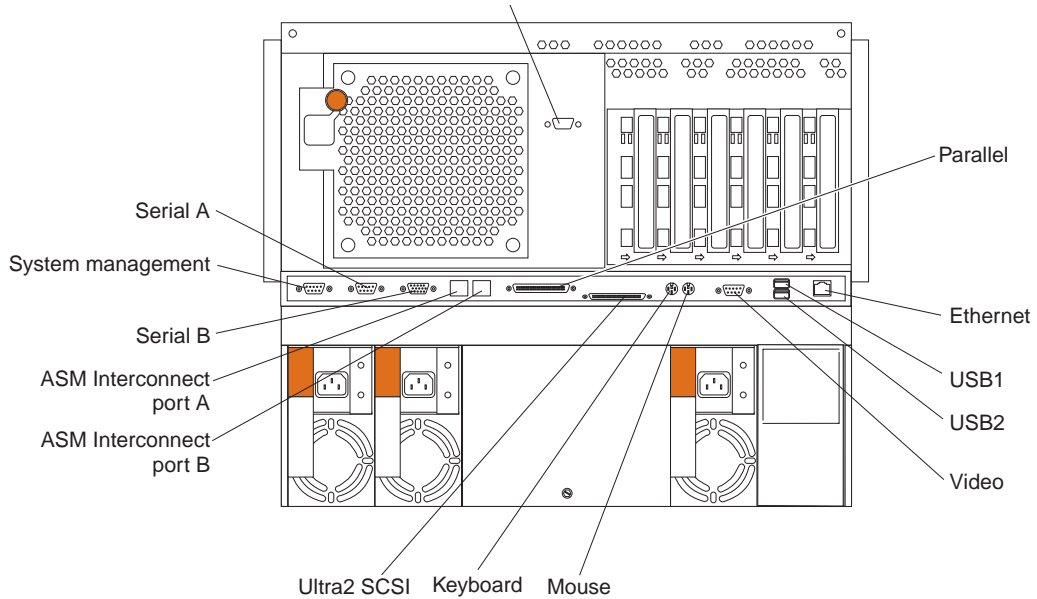

Refer to the following illustration for an example of proper cable routing.

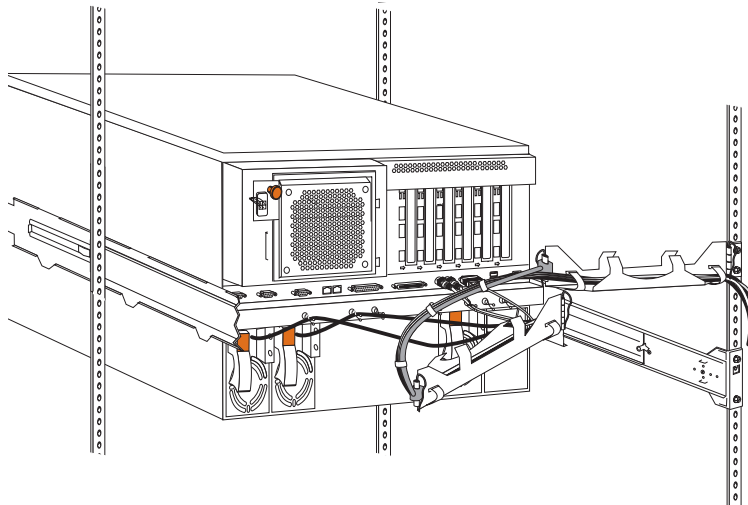

Chapter 3. Starting the server

Use the following procedure to start your server.

1. Turn on all external devices, such as the monitor.

Note: After you plug the power cord into an outlet, wait 20 seconds before pressing the power control button. During this time, the power control button will not respond because the system management microprocessor is being initialized.

2. Press the power control button on the front of the server. The power-on light comes on and the power-on self-test (POST) begins.

Controls and indicators

The following illustration shows the controls and indicators on the server.

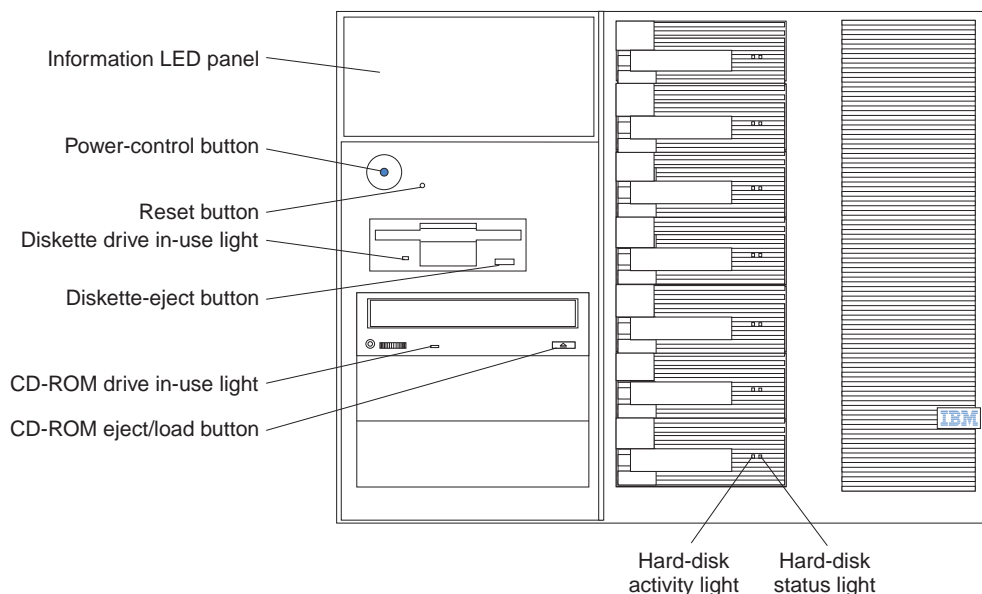

Hard-disk drive status light: Each of the hot-swap drives has a status light. When this amber light is on continuously, the drive has failed. When the light flashes slowly (one flash per second), the drive is being rebuilt. When the light flashes rapidly (three flashes per second), the controller is identifying the drive.

Hard-disk activity light: Each of the hot-swap drives has a hard-disk activity light. When this green light is flashing, the drive is being accessed.

CD-ROM eject/load button: Press this button to eject or retract the CD-ROM tray.

CD-ROM drive in-use light: When this light is on, the CD-ROM drive is being accessed.

Diskette-eject button: Press this button to eject a diskette from the drive.

Diskette drive in-use light: When this light is on, the diskette drive is being accessed.

Reset button: Press this button to reset the server and run the power-on self-test (POST).

Power control button: Press this button to manually turn on or off the server.

You can start the server in several ways:

- You can turn on the server by pressing the Power Control button on the front of the server.

Note: After you plug the power cords of your server into electrical outlets, wait 20 seconds before pressing the Power Control button. During this time the system-management processor is initializing and the Power Control button does not respond.

- If the server is turned on, a power failure occurs, and unattended-start mode is enabled in the Configuration/Setup utility program, the server will start automatically when power is restored.
- If AC power is present, the server is off, and the wake-up feature is enabled in the Configuration/Setup utility program, the wake-up feature will turn on the server at the set time.
- If AC power is present, the server is off, and ring-signal detect is enabled in the Configuration/Setup utility program, you can turn on the server by telephone input.
- The Netfinity Advanced System Management Processor also can turn on the server.

You can turn off the server in several ways:

- You can turn off the server by pressing the Power Control button on the front of the server. Pressing the Power Control button starts an orderly shutdown of the operating system, if this feature is supported by your operating system, and places the server in standby mode.

Statement 5



CAUTION:

The power control button on the device and the power supply do not turn off the electrical current supplied to the device. The device also might have more than one power cord. To remove all electrical current from the device, ensure that all power cords are disconnected from the power source.

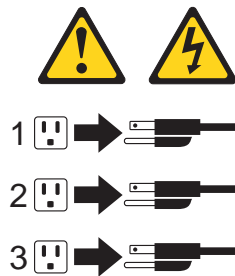

Note: After turning off the server, wait at least 5 seconds before pressing the Power Control button to power the server on again.

- You can press and hold the Power Control button for more than 4 seconds to cause an immediate shutdown of the server and place the server in standby mode. You can use this feature if the operating system stalls.
- You can disconnect the server power cords from the electrical outlets to shut off all power to the server.

Note: Wait about 15 seconds after disconnecting the power cords for your system to stop running. Watch for the System Power light on the operator information panel to stop blinking.

Information LED panel: The lights on this panel give status information for your server. See “Information LED panel”.

Information LED panel

The following illustration shows the status lights on the Information LED panel.

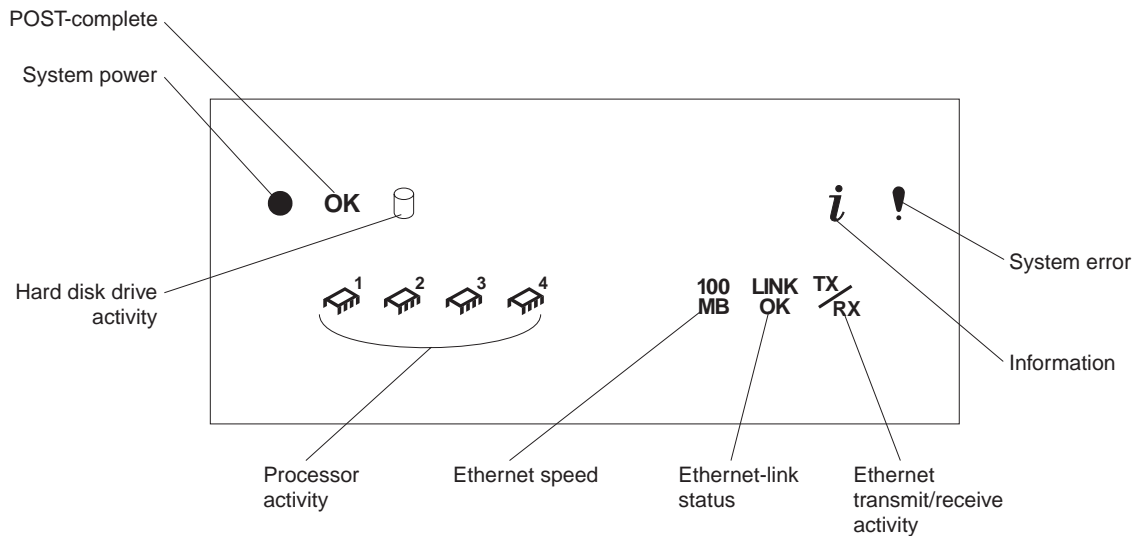

System power light: When this green light is on, power is present in the server. When this light flashes, the server is in standby mode (the system power supply is turned off and ac current is present). When this light is off, the power subsystem, the ac power, or a light has failed.

Attention: If the system power light is off, it does not mean there is no electrical current present in the server. The light might be burned out. To remove all electrical current from the server, you must unplug the server power cords from the electrical outlets or from the uninterruptible power device.

POST-complete light: This green light is on when the power-on self-test (POST) completes without any errors.

Hard disk drive activity light: This green light flickers when there is activity on a hard disk drive.

Processor activity lights: One or more of these green lights are on when there is microprocessor activity. The number of lights that are on indicates the number of microprocessors with activity.

Information light: When this amber light is on, the server power supplies are nonredundant or some other noncritical event has occurred. The event is recorded in the Event log. See the *User's Reference* on the *IBM Netfinity Documentation CD* for instructions on viewing the Event log.

Ethernet transmit/receive activity light: When this green light is on, there is activity between the server and the network.

System error light: This amber light is on when a system error occurs. A light on the diagnostics LED panel will also be on to further isolate the error. (For more information, see the *User's Reference* on the *IBM Netfinity Documentation CD*.)

Ethernet-link status light: When this green light is on, there is an active connection on the Ethernet port.

Ethernet speed 100 Mbps: When this green light is on, the Ethernet speed is 100 Mbps. When the light is off, the Ethernet speed is 10 Mbps.

Chapter 4. Configuring your server

The ServerGuide CDs provide software setup tools and installation tools that are specifically designed for your IBM Netfinity server. Use these CDs during the initial installation of your server to configure basic hardware features and to simplify your network operating system installation. (See “Using the ServerGuide CDs” for more information.) The ServerGuide CDs also contain a collection of application programs, which you can install after your server is up and running.

In addition to the ServerGuide CDs, you can use the following configuration programs to customize your server hardware:

- **Configuration/Setup Utility**

The Configuration/Setup Utility program is part of the *basic input/output system (BIOS)* code that comes with your server. You can use this program to configure serial and parallel port assignments, change interrupt request (IRQ) settings, change the drive startup sequence, set the date and time, and set passwords.

- **SCSISelect Utility**

With the built-in SCSISelect Utility program, you can configure the devices that are attached to the integrated SCSI controller. Use this program to change default values, resolve configuration conflicts, and perform a low-level format on a SCSI hard disk drive.

- **ServeRAID programs**

Your server comes with a ServeRAID adapter installed. You must use the ServeRAID configuration program to define and configure your disk-array subsystem before you install your operating system.

Attention: Refer to the *User's Reference* on the *IBM Netfinity Documentation* CD for detailed instructions for using the configuration programs and ServerGuide CDs.

Using the ServerGuide CDs

The ServerGuide CDs provide state-of-the-art programs to detect the server model and hardware options that are installed, configure Netfinity server hardware, provide device drivers, and install your network operating system (NOS).

Note: If the ServerGuide CD does not start, see “ServerGuide startup problems” on page 26.

1. Insert the *Netfinity Setup and Installation* CD, and restart the server.
2. Follow the instructions on the screens to:
 - a. Select your language.
 - b. Select your keyboard layout and country.
 - c. View the Overview to learn about ServerGuide features.
 - d. View the README file to review installation tips about your NOS and adapter.
 - e. Start the setup and hardware configuration programs.
 - f. Start the NOS installation. You will need your copy of the NOS CD.

Note: For information on the supported NOS versions, refer to the *Netfinity Setup and Installation* CD label.

After installing the NOS

Be sure to take advantage of the following additional software that is included with the ServerGuide package:

- *Operating System Updates* CDs — include selected NOS updates that are provided by NOS software developers.
- *Netfinity Applications* CDs — include powerful applications that are ready to install; their use requires no software keys.

Note: See the CD labels for a current list of updates and applications or start the *Netfinity Applications* and view the online overview.

Netfinity systems management solutions

Your IBM Netfinity server includes the Advanced System Management Processor. This systems management subsystem monitors your Netfinity server and notifies you when problems occur. It performs automated actions if specified thresholds are reached and enables you to resolve system problems remotely (using a serial or Advanced System Management Interconnect connection), even if the server is powered down or the operating system has locked up.

Your server comes with the *IBM Netfinity Manager*[™] program and *Client Services for Netfinity Manager version 5.2*

Some versions of the ServerGuide package contain the IBM Netfinity Manager software. For information about how to install applications that are included in the ServerGuide package, see the ServerGuide information.

IBM Netfinity Manager is a comprehensive set of hardware management utilities. These utilities enable you to manage industry-standard, Intel-processor-based, server, desktop, workstation, and notebook systems over network operating systems from Microsoft, SCO, Novell, and IBM. These utilities support multiple protocols, including TCP/IP, IPX, NetBIOS, SNA, SLIP, and HTTP. This robust set of systems management software tools delivers comprehensive local and remote system control over the entire life cycle of the system.

Chapter 5. Solving problems

This section provides basic troubleshooting information to help you resolve some common problems that might occur while setting up your server.

If you cannot locate and correct the problem using the information in this section, refer to the "Solving problems" section on the *IBM Netfinity Documentation* CD and the "Support for Netfinity Servers" flowchart in the front of this booklet.

POST beep code descriptions

POST emits one beep to signal successful completion. If POST detects a problem during startup, other beep codes might occur. You can use the following beep code descriptions to help identify and resolve problems that are detected during startup.

Note: See the "Solving problems" section of the *User's Reference* on the *IBM Netfinity Documentation* CD for more information about the POST beep codes.

Beep code	Descriptions of the POST beep codes
No beep	Call for service.
Continuous	If no video appears, the startup microprocessor failed. Verify that the startup microprocessor is installed correctly. If it is, replace the startup microprocessor. If the problem persists, call for service.
One short	POST completed successfully. One beep also occurs after POST if you enter an incorrect password.
Two short	Follow the instructions that appear on the screen.
Three short	POST detected a system memory error. Verify that the memory is installed correctly. If it is, replace the failing memory module.
Repeating short	The system board might contain a failing component. <ol style="list-style-type: none">1. Verify that the keyboard and pointing devices are connected properly.2. Ensure that nothing is resting on the keyboard.3. Disconnect the pointing device; then, restart the server. If the problem goes away, replace the pointing device. If the problem remains, call for service.
One long and one short	If the video controller on the system board is being used, call for service. If you installed an optional video adapter, replace the failing adapter.
One long and two short	A video I/O adapter ROM is not readable, or the video subsystem is defective. If you installed an optional video adapter, replace the failing adapter. If the problem remains, call for service.
One long and three short	The system-board video subsystem has not detected a monitor connection to the server. Ensure that the monitor is connected to the server. If the problem persists, replace the monitor.

Table 3. POST beep code descriptions

Post error messages

Beep code	Descriptions of the POST beep codes
Two long and two short	POST does not support the optional video adapter. Replace the optional video adapter with one that is supported by the server or use the integrated video controller.
All other beep codes	<ol style="list-style-type: none">1. Verify that the system memory modules are installed correctly.2. Tun off the server; then, restart the server. If the problem remains, call for service.

Table 3. POST beep code descriptions

POST error messages

The following table provides an abbreviated list of the error messages that might appear during POST.

Note: See the "Solving problems" section of the *User's Reference* on the *IBM Netfinity Documentation* CD for more information about the POST beep codes.

POST message	Failing device or problem found	Suggested action
129	L1 cache of a microprocessor	Check the installation of your microprocessors.
162	Change in device configuration	Verify that your optional devices are turned on and installed correctly.
163	Time of day has not been set	Set the correct date and time.
164	Change in memory configuration	Verify that your memory is installed properly; then, restart the server and run the Configuration/Setup Utility program.
201	Change in memory configuration	Verify that your memory is fully seated and installed properly.
229	L2 cache of a microprocessor	Check the installation of your microprocessors.
289	Failing DIMM was disabled	Verify that your memory is correct for your server and that it is installed properly.
301 303	Keyboard and keyboard controller	Ensure that the keyboard cable is connected and nothing is resting on the keyboard keys.
962	Parallel port configuration error	Start the Configuration/Setup program and verify that the parallel-port setting is correct.
11xx	Serial port error	Verify that the serial cable is connected correctly.
1162	Serial port configuration conflict	Start the Configuration/Setup program and ensure that the IRQ and I/O port assignments needed by the serial port are available.
1601	BIOS update needed	Download and install the latest system BIOS level.
1800	PCI adapter hardware interrupt	Start the Configuration/Setup program and verify that the interrupt resource settings are correct.
2400 2462	Video controller and memory	Verify that the monitor is connected correctly.
00019xxx	Processor <i>x</i> is not functioning or failed the built-in test	Verify that processor <i>x</i> is installed correctly. If the problem remains, replace processor <i>x</i> .
00180xxx	A PCI adapter requested a resource that is not available	Start the Configuration/Setup program and ensure that the resources needed by the PCI adapter are available.
012980xx 012981xx	Data for processor <i>x</i>	Download and install the latest system BIOS level.
01298200	Microprocessor speed mismatch	Install microprocessors with identical speeds.
I9990305	POST could not find an operating system.	Install your operating system.

Table 4. Abbreviated list of POST error messages

ServerGuide startup problems

Look for the symptom in the left column of the chart. Probable solutions to the problem are in the right column.

Setup	Suggested action
<i>Netfinity Setup and Installation CD</i> won't start.	<ul style="list-style-type: none"> • Be sure the system is a supported Netfinity server with a startable (bootable) CD-ROM drive. • If the startup (boot) sequence settings have been altered, be sure the CD-ROM is first in the boot sequence. • If more than one CD-ROM drive is installed, be sure that only one drive is set as the primary drive. Start the CD from the primary drive.
ServeRAID program cannot view all installed drives - or - cannot install NOS.	<ul style="list-style-type: none"> • Be sure there are no duplicate SCSI IDs or IRQ assignments. • Be sure that the hard disk drive is connected properly.
The <i>Operating System Installation</i> program continuously loops.	Free up more space on the hard disk.
ServerGuide won't start <i>your</i> NOS CD.	Be sure the NOS CD you have is supported by ServerGuide. See the <i>Netfinity Setup and Installation CD</i> label for a list of NOS versions supported.
Can't install NOS - option is grayed out.	Either there is no logical drive defined (ServeRAID systems) or the ServerGuide system partition is not present. Run the setup and configuration program.

TechConnect CD	Suggested action
Can't start TechConnect CD.	Be sure you're starting the CD on a system with Microsoft Windows installed.
Can't view publications from TechConnect CD, or text is unreadable.	Be sure you have the Adobe reader installed (available from the TechConnect CD).

Diskette Factory CD	Suggested action
Get "time out" or "Unknown host" errors	Be sure you have access to the Internet through FTP directly.

Troubleshooting chart

Notes:

1. Refer to the "Solving problems" section of the *User's Reference* on the *IBM Netfinity Documentation* CD for more detailed troubleshooting charts.
2. If you cannot find the problem in the troubleshooting charts, run the diagnostic programs. If you have run the diagnostic test programs, or if running the tests does not reveal the problem, call for service.

Monitor problems	Suggested action
Testing	<p>Some IBM monitors have their own self-tests. If you suspect a problem with your monitor, refer to the information that comes with the monitor for adjusting and testing instructions.</p> <p>If you still cannot find the problem, call for service.</p>
The screen is blank.	<p>Verify that:</p> <ol style="list-style-type: none"> 1. The server power cord is plugged into the server and a working electrical outlet. 2. The monitor cables are connected properly. 3. The monitor is turned on, and the Brightness and Contrast controls are adjusted correctly. <p>If the items above are correct and the screen remains blank, call for service.</p>
Only the cursor appears.	Call for service.
The monitor works when you turn on the server, but goes blank when you start some application programs.	<p>Verify that:</p> <ol style="list-style-type: none"> 1. The primary monitor cable is connected to the video port. 2. You installed the necessary device drivers for the applications. <p>If the items above are correct and the screen remains blank, call for service.</p>
Wavy, unreadable, rolling, distorted screen, or screen jitter.	<p>If the monitor self-tests show the monitor is OK, consider the location of the monitor. Magnetic fields around other devices (such as transformers, appliances, fluorescent lights, and other monitors) can cause screen jitter or wavy, unreadable, rolling, or distorted screen images. If this happens, turn off the monitor. (Moving a color monitor while it is turned on might cause screen discoloration.) Then move the device and the monitor at least 305 mm (12 in.) apart. Turn on the monitor.</p> <p>Notes:</p> <ol style="list-style-type: none"> 1. To prevent diskette drive read/write errors, be sure the distance between monitors and diskette drives is at least 76 mm (3 in.). 2. Non-IBM monitor cables might cause unpredictable problems. 3. An enhanced monitor cable with additional shielding is available for the 9521 and 9527 monitors. For information about the enhanced monitor cable, see your IBM reseller or IBM marketing representative. <p>If the problem remains, call for service.</p>
Wrong characters appear on the screen.	<p>If the wrong language is displayed, update the BIOS with the correct language.</p> <p>If the problem remains, call for service.</p>

Troubleshooting chart

Power problems	Suggested action
The server does not power on.	Verify that: <ol style="list-style-type: none"> 1. The power cables are properly connected to the server. 2. The electrical outlet functions properly. 3. The type of memory that is installed is correct. 4. If you just installed an option, remove it, and restart the server. If the server now powers on, you might have installed more options than the power supply can support. 5. The LEDs on the power supply are on. If the problem remains, call for service.
Microprocessor problems	Suggested action
The server emits a continuous tone during POST.	The startup (boot) microprocessor is not working properly. Verify that the startup microprocessor is seated properly. If it is, replace the startup microprocessor. If the problem remains, call for service.
Memory problems	Suggested action
The amount of memory displayed is less than the amount of memory installed.	Verify that: <ol style="list-style-type: none"> 1. The memory modules are seated properly. 2. You have installed the correct type of memory. 3. If you changed the memory, you updated the memory configuration using the Configuration/Setup Utility program. 4. All banks of memory on the DIMMs are enabled. The server might have detected a problem and automatically disabled a DIMM bank, or a DIMM bank could have been manually disabled. If the above items are correct, run the memory-diagnostic program. The system might have detected a bad memory module and automatically reallocated memory to enable you to continue to operate. If the memory tests fail, call for service or replace the failing DIMM.

Option problems	Suggested action
An IBM option that was just installed does not work.	<p>Verify that:</p> <ol style="list-style-type: none"> 1. The server supports the option. Refer to the "Support for Netfinity Servers" flowchart for information about obtaining ServerProven™ compatibility information from the World Wide Web. 2. You followed the installation instructions that came with the option. 3. The option is installed correctly. 4. You have not loosened any other installed options or cables. 5. You updated the configuration information using the Configuration/Setup Utility program. Whenever memory or an option is changed, you must update the configuration. <p>If the problem remains, call for service.</p>
Expansion enclosure problems	Suggested action
The SCSI expansion enclosure used to work, but does not work now.	<p>Verify that:</p> <ol style="list-style-type: none"> 1. The cables for all external SCSI options are connected correctly. 2. The last option in each SCSI chain, or the end of the SCSI cable, is terminated correctly. 3. Any external SCSI option is turned on. You must turn on an external SCSI option before turning on the server. <p>For more information, see the documentation for your SCSI options and expansion enclosure.</p>
Service processor problems	Suggested action
Netfinity Service Processor Manager reports a general monitor failure	<p>Disconnect the server from all electrical sources, wait for 30 seconds, reconnect the server to the electrical sources, and restart the server.</p> <p>If a problem remains, call for service.</p>

Troubleshooting chart

Appendix A. Product warranties and notices

This chapter contains warranty and emission notices. It also contains trademarks and general-information notices.

Warranty Statements

The warranty statements consist of two parts: Part 1 and Part 2. Part 1 varies by country. Part 2 is the same for all countries. Be sure to read both the Part 1 that applies to your country and Part 2.

- **United States, Puerto Rico, and Canada (Z125-4753-05 11/97)**
(Part 1 - General Terms)
- **Worldwide except Canada, Puerto Rico, Turkey, and United States (Z125-5697-01 11/97)**
("Part 1 - General Terms," on page 34)
- **Worldwide Country-Unique Terms**
("Part 2 - Worldwide Country-Unique Terms" on page 36)

IBM Statement of Limited Warranty for United States, Puerto Rico, and Canada (Part 1 - General Terms)

This Statement of Limited Warranty includes Part 1 - General Terms and Part 2 - Country-unique Terms. ***The terms of Part 2 may replace or modify those of Part 1.*** The warranties provided by IBM in this Statement of Limited Warranty apply only to Machines you purchase for your use, and not for resale, from IBM or your reseller. The term "Machine" means an IBM machine, its features, conversions, upgrades, elements, or accessories, or any combination of them. The term "Machine" does not include any software programs, whether pre-loaded with the Machine, installed subsequently or otherwise. Unless IBM specifies otherwise, the following warranties apply only in the country where you acquire the Machine. Nothing in this Statement of Warranty affects any statutory rights of consumers that cannot be waived or limited by contract. If you have any questions, contact IBM or your reseller.

Machine - Netfinity 7600

Warranty Period* - Three Years

*Contact your place of purchase for warranty service information. Some IBM Machines are eligible for On-site warranty service depending on the country where service is performed.

The IBM Warranty for Machines

IBM warrants that each Machine 1) is free from defects in materials and workmanship and 2) conforms to IBM's Official Published Specifications. The warranty period for a Machine is a specified, fixed period commencing on its Date of Installation. The date on your sales receipt is the Date of Installation, unless IBM or your reseller informs you otherwise.

During the warranty period IBM or your reseller, if approved by IBM to provide warranty service, will provide repair and exchange service for the Machine, without charge, under the type of service designated for the Machine and will manage and install engineering changes that apply to the Machine.

If a Machine does not function as warranted during the warranty period, and IBM or your reseller are unable to either 1) make it do so or 2) replace it with one that is at least functionally equivalent, you may return it to your place of purchase and your money will be refunded. The replacement may not be new, but will be in good working order.

Extent of Warranty

The warranty does not cover the repair or exchange of a Machine resulting from misuse, accident, modification, unsuitable physical or operating environment, improper maintenance by you, or failure caused by a product for which IBM is not responsible. The warranty is voided by removal or alteration of Machine or parts identification labels.

THESE WARRANTIES ARE YOUR EXCLUSIVE WARRANTIES AND REPLACE ALL OTHER WARRANTIES OR CONDITIONS, EXPRESS OR IMPLIED, INCLUDING, BUT NOT LIMITED TO, THE IMPLIED WARRANTIES OR CONDITIONS OF MERCHANTABILITY AND FITNESS FOR A PARTICULAR PURPOSE. THESE WARRANTIES GIVE YOU SPECIFIC LEGAL RIGHTS AND YOU MAY ALSO HAVE OTHER RIGHTS WHICH VARY FROM JURISDICTION TO JURISDICTION. SOME JURISDICTIONS DO NOT ALLOW THE EXCLUSION OR LIMITATION OF EXPRESS OR IMPLIED WARRANTIES, SO THE ABOVE EXCLUSION OR LIMITATION MAY NOT APPLY TO YOU. IN THAT EVENT, SUCH WARRANTIES ARE LIMITED IN DURATION TO THE WARRANTY PERIOD. NO WARRANTIES APPLY AFTER THAT PERIOD.

Items Not Covered by Warranty

IBM does not warrant uninterrupted or error-free operation of a Machine.

Unless specified otherwise, IBM provides non-IBM machines **WITHOUT WARRANTIES OF ANY KIND.**

Any technical or other support provided for a Machine under warranty, such as assistance via telephone with "how-to" questions and those regarding Machine set-up and installation, will be provided **WITHOUT WARRANTIES OF ANY KIND.**

Warranty Service

To obtain warranty service for the Machine, contact your reseller or IBM. In the United States, call IBM at 1-800-772-2227. In Canada, call IBM at 1-800-565-3344. You may be required to present proof of purchase.

IBM or your reseller provides certain types of repair and exchange service, either at your location or at a service center, to keep Machines in, or restore them to, conformance with their Specifications. IBM or your reseller will inform you of the available types of service for a Machine based on its country of installation. IBM may repair the failing Machine or exchange it at its discretion.

When warranty service involves the exchange of a Machine or part, the item IBM or your reseller replaces becomes its property and the replacement becomes yours. You represent that all removed items are genuine and unaltered. The replacement may not be new, but will be in good working order and at least functionally equivalent to the item replaced. The replacement assumes the warranty service status of the replaced item.

Any feature, conversion, or upgrade IBM or your reseller services must be installed on a Machine which is 1) for certain Machines, the designated, serial-numbered Machine and 2) at an engineering-change level compatible with the feature, conversion, or

upgrade. Many features, conversions, or upgrades involve the removal of parts and their return to IBM. A part that replaces a removed part will assume the warranty service status of the removed part.

Before IBM or your reseller exchanges a Machine or part, you agree to remove all features, parts, options, alterations, and attachments not under warranty service.

You also agree to

1. ensure that the Machine is free of any legal obligations or restrictions that prevent its exchange;
2. obtain authorization from the owner to have IBM or your reseller service a Machine that you do not own; and
3. where applicable, before service is provided
 - a. follow the problem determination, problem analysis, and service request procedures that IBM or your reseller provides,
 - b. secure all programs, data, and funds contained in a Machine,
 - c. provide IBM or your reseller with sufficient, free, and safe access to your facilities to permit them to fulfill their obligations, and
 - d. inform IBM or your reseller of changes in a Machine's location.

IBM is responsible for loss of, or damage to, your Machine while it is 1) in IBM's possession or 2) in transit in those cases where IBM is responsible for the transportation charges.

Neither IBM nor your reseller is responsible for any of your confidential, proprietary or personal information contained in a Machine which you return to IBM or your reseller for any reason. You should remove all such information from the Machine prior to its return.

Production Status

Each IBM Machine is manufactured from new parts, or new and used parts. In some cases, the Machine may not be new and may have been previously installed. Regardless of the Machine's production status, IBM's appropriate warranty terms apply.

Limitation of Liability

Circumstances may arise where, because of a default on IBM's part or other liability, you are entitled to recover damages from IBM. In each such instance, regardless of the basis on which you are entitled to claim damages from IBM (including fundamental breach, negligence, misrepresentation, or other contract or tort claim), IBM is liable for no more than

1. damages for bodily injury (including death) and damage to real property and tangible personal property; and
2. the amount of any other actual direct damages, up to the greater of U.S. \$100,000 (or equivalent in local currency) or the charges (if recurring, 12 months' charges apply) for the Machine that is the subject of the claim.

This limit also applies to IBM's suppliers and your reseller. It is the maximum for which IBM, its suppliers, and your reseller are collectively responsible.

UNDER NO CIRCUMSTANCES IS IBM LIABLE FOR ANY OF THE FOLLOWING: 1) THIRD-PARTY CLAIMS AGAINST YOU FOR DAMAGES (OTHER THAN THOSE UNDER THE FIRST ITEM LISTED ABOVE); 2) LOSS OF, OR DAMAGE TO, YOUR RECORDS OR DATA; OR 3) SPECIAL, INCIDENTAL, OR INDIRECT DAMAGES OR FOR ANY ECONOMIC CONSEQUENTIAL DAMAGES (INCLUDING LOST PROFITS OR SAVINGS), EVEN IF IBM, ITS SUPPLIERS OR YOUR RESELLER IS INFORMED OF THEIR POSSIBILITY.

SOME JURISDICTIONS DO NOT ALLOW THE EXCLUSION OR LIMITATION OF INCIDENTAL OR CONSEQUENTIAL DAMAGES, SO THE ABOVE LIMITATION OR EXCLUSION MAY NOT APPLY TO YOU.

IBM Statement of Warranty Worldwide except Canada, Puerto Rico, Turkey, United States (Part 1 – General Terms)

This Statement of Warranty includes Part 1 - General Terms and Part 2 - Country-unique Terms. **The terms of Part 2 may replace or modify those of Part 1.** The warranties provided by IBM in this Statement of Warranty apply only to Machines you purchase for your use, and not for resale, from IBM or your reseller. The term "Machine" means an IBM machine, its features, conversions, upgrades, elements, or accessories, or any combination of them. The term "Machine" does not include any software programs, whether pre-loaded with the Machine, installed subsequently or otherwise. Unless IBM specifies otherwise, the following warranties apply only in the country where you acquire the Machine. Nothing in this Statement of Warranty affects any statutory rights of consumers that cannot be waived or limited by contract. If you have any questions, contact IBM or your reseller.

Machine - Netfinity 7600

Warranty Period* - Three Years

*Contact your place of purchase for warranty service information. Some IBM Machines are eligible for On-site warranty service depending on the country where service is performed.

The IBM Warranty for Machines

IBM warrants that each Machine 1) is free from defects in materials and workmanship and 2) conforms to IBM's Official Published Specifications. The warranty period for a Machine is a specified, fixed period commencing on its Date of Installation. The date on your sales receipt is the Date of Installation, unless IBM or your reseller informs you otherwise.

During the warranty period IBM or your reseller, if approved by IBM to provide warranty service, will provide repair and exchange service for the Machine, without charge, under the type of service designated for the Machine and will manage and install engineering changes that apply to the Machine.

If a Machine does not function as warranted during the warranty period, and IBM or your reseller are unable to either 1) make it do so or 2) replace it with one that is at least functionally equivalent, you may return it to your place of purchase and your money will be refunded. The replacement may not be new, but will be in good working order.

Extent of Warranty

The warranty does not cover the repair or exchange of a Machine resulting from misuse, accident, modification, unsuitable physical or operating environment, improper maintenance by you, or failure caused by a product for which IBM is not responsible. The warranty is voided by removal or alteration of Machine or parts identification labels.

THESE WARRANTIES ARE YOUR EXCLUSIVE WARRANTIES AND REPLACE ALL OTHER WARRANTIES OR CONDITIONS, EXPRESS OR IMPLIED, INCLUDING, BUT NOT LIMITED TO, THE IMPLIED WARRANTIES OR

CONDITIONS OF MERCHANTABILITY AND FITNESS FOR A PARTICULAR PURPOSE. THESE WARRANTIES GIVE YOU SPECIFIC LEGAL RIGHTS AND YOU MAY ALSO HAVE OTHER RIGHTS WHICH VARY FROM JURISDICTION TO JURISDICTION. SOME JURISDICTIONS DO NOT ALLOW THE EXCLUSION OR LIMITATION OF EXPRESS OR IMPLIED WARRANTIES, SO THE ABOVE EXCLUSION OR LIMITATION MAY NOT APPLY TO YOU. IN THAT EVENT, SUCH WARRANTIES ARE LIMITED IN DURATION TO THE WARRANTY PERIOD. NO WARRANTIES APPLY AFTER THAT PERIOD.

Items Not Covered by Warranty

IBM does not warrant uninterrupted or error-free operation of a Machine.

Unless specified otherwise, IBM provides non-IBM machines **WITHOUT WARRANTIES OF ANY KIND.**

Any technical or other support provided for a Machine under warranty, such as assistance via telephone with "how-to" questions and those regarding Machine set-up and installation, will be provided **WITHOUT WARRANTIES OF ANY KIND.**

Warranty Service

To obtain warranty service for the Machine, contact your reseller or IBM. You may be required to present proof of purchase.

IBM or your reseller provides certain types of repair and exchange service, either at your location or at a service center, to keep Machines in, or restore them to, conformance with their Specifications. IBM or your reseller will inform you of the available types of service for a Machine based on its country of installation. IBM may repair the failing Machine or exchange it at its discretion.

When warranty service involves the exchange of a Machine or part, the item IBM or your reseller replaces becomes its property and the replacement becomes yours. You represent that all removed items are genuine and unaltered. The replacement may not be new, but will be in good working order and at least functionally equivalent to the item replaced. The replacement assumes the warranty service status of the replaced item.

Any feature, conversion, or upgrade IBM or your reseller services must be installed on a Machine which is 1) for certain Machines, the designated, serial-numbered Machine and 2) at an engineering-change level compatible with the feature, conversion, or upgrade. Many features, conversions, or upgrades involve the removal of parts and their return to IBM. A part that replaces a removed part will assume the warranty service status of the removed part.

Before IBM or your reseller exchanges a Machine or part, you agree to remove all features, parts, options, alterations, and attachments not under warranty service.

You also agree to

1. ensure that the Machine is free of any legal obligations or restrictions that prevent its exchange;
2. obtain authorization from the owner to have IBM or your reseller service a Machine that you do not own; and
3. where applicable, before service is provided
 - a. follow the problem determination, problem analysis, and service request procedures that IBM or your reseller provides,
 - b. secure all programs, data, and funds contained in a Machine,
 - c. provide IBM or your reseller with sufficient, free, and safe access to your facilities to permit them to fulfill their obligations, and
 - d. inform IBM or your reseller of changes in a Machine's location.

IBM is responsible for loss of, or damage to, your Machine while it is 1) in IBM's possession or 2) in transit in those cases where IBM is responsible for the transportation charges.

Neither IBM nor your reseller is responsible for any of your confidential, proprietary or personal information contained in a Machine which you return to IBM or your reseller for any reason. You should remove all such information from the Machine prior to its return.

Production Status

Each IBM Machine is manufactured from new parts, or new and used parts. In some cases, the Machine may not be new and may have been previously installed. Regardless of the Machine's production status, IBM's appropriate warranty terms apply.

Limitation of Liability

Circumstances may arise where, because of a default on IBM's part or other liability, you are entitled to recover damages from IBM. In each such instance, regardless of the basis on which you are entitled to claim damages from IBM (including fundamental breach, negligence, misrepresentation, or other contract or tort claim), IBM is liable for no more than

1. damages for bodily injury (including death) and damage to real property and tangible personal property; and
2. the amount of any other actual direct damages, up to the greater of U.S. \$100,000 (or equivalent in local currency) or the charges (if recurring, 12 months' charges apply) for the Machine that is the subject of the claim.

This limit also applies to IBM's suppliers and your reseller. It is the maximum for which IBM, its suppliers, and your reseller are collectively responsible.

UNDER NO CIRCUMSTANCES IS IBM LIABLE FOR ANY OF THE FOLLOWING: 1) THIRD-PARTY CLAIMS AGAINST YOU FOR DAMAGES (OTHER THAN THOSE UNDER THE FIRST ITEM LISTED ABOVE); 2) LOSS OF, OR DAMAGE TO, YOUR RECORDS OR DATA; OR 3) SPECIAL, INCIDENTAL, OR INDIRECT DAMAGES OR FOR ANY ECONOMIC CONSEQUENTIAL DAMAGES (INCLUDING LOST PROFITS OR SAVINGS), EVEN IF IBM, ITS SUPPLIERS OR YOUR RESELLER IS INFORMED OF THEIR POSSIBILITY. SOME JURISDICTIONS DO NOT ALLOW THE EXCLUSION OR LIMITATION OF INCIDENTAL OR CONSEQUENTIAL DAMAGES, SO THE ABOVE LIMITATION OR EXCLUSION MAY NOT APPLY TO YOU.

Part 2 - Worldwide Country-Unique Terms

ASIA PACIFIC

AUSTRALIA: The IBM Warranty for Machines: The following paragraph is added to this Section:

The warranties specified in this Section are in addition to any rights you may have under the Trade Practices Act 1974 or other legislation and are only limited to the extent permitted by the applicable legislation.

Extent of Warranty: The following replaces the first and second sentences of this Section:

The warranty does not cover the repair or exchange of a Machine resulting from misuse, accident, modification, unsuitable physical or operating environment, operation in other than the Specified Operating Environment, improper maintenance by you, or failure caused by a product for which IBM is not responsible.

Limitation of Liability: The following is added to this Section:

Where IBM is in breach of a condition or warranty implied by the Trade Practices Act 1974, IBM's liability is limited to the repair or replacement of the goods or the supply of equivalent goods. Where that condition or warranty relates to right to sell, quiet possession or clear title, or the goods are of a kind ordinarily acquired for personal, domestic or household use or consumption, then none of the limitations in this paragraph apply.

PEOPLE'S REPUBLIC OF CHINA: Governing Law: The following is added to this Statement:

The laws of the State of New York govern this Statement.

INDIA: Limitation of Liability: The following replaces items 1 and 2 of this Section:

1. liability for bodily injury (including death) or damage to real property and tangible personal property will be limited to that caused by IBM's negligence;
2. as to any other actual damage arising in any situation involving nonperformance by IBM pursuant to, or in any way related to the subject of this Statement of Warranty, IBM's liability will be limited to the charge paid by you for the individual Machine that is the subject of the claim.

NEW ZEALAND: The IBM Warranty for Machines: The following paragraph is added to this Section:

The warranties specified in this Section are in addition to any rights you may have under the Consumer Guarantees Act 1993 or other legislation which cannot be excluded or limited. The Consumer Guarantees Act 1993 will not apply in respect of any goods which IBM provides, if you require the goods for the purposes of a business as defined in that Act.

Limitation of Liability: The following is added to this Section:

Where Machines are not acquired for the purposes of a business as defined in the Consumer Guarantees Act 1993, the limitations in this Section are subject to the limitations in that Act.

EUROPE, MIDDLE EAST, AFRICA (EMEA)

The following terms apply to all EMEA countries.

The terms of this Statement of Warranty apply to Machines purchased from an IBM reseller. If you purchased this Machine from IBM, the terms and conditions of the applicable IBM agreement prevail over this warranty statement.

Warranty Service

If you purchased an IBM Machine in Austria, Belgium, Denmark, Estonia, Finland, France, Germany, Greece, Iceland, Ireland, Italy, Latvia, Lithuania, Luxembourg, Netherlands, Norway, Portugal, Spain, Sweden, Switzerland or United Kingdom, you may obtain warranty service for that Machine in any of those countries from either (1) an IBM reseller approved to perform warranty service or (2) from IBM.

If you purchased an IBM Personal Computer Machine in Albania, Armenia, Belarus, Bosnia and Herzegovina, Bulgaria, Croatia, Czech Republic, Georgia, Hungary, Kazakhstan, Kirghizia, Federal Republic of Yugoslavia, Former Yugoslav Republic of Macedonia (FYROM), Moldova, Poland, Romania, Russia, Slovak Republic, Slovenia, or Ukraine, you may obtain warranty service for that Machine in any of those countries from either (1) an IBM reseller approved to perform warranty service or (2) from IBM.

The applicable laws, Country-unique terms and competent court for this Statement are those of the country in which the warranty service is being provided. However,

the laws of Austria govern this Statement if the warranty service is provided in Albania, Armenia, Belarus, Bosnia and Herzegovina, Bulgaria, Croatia, Czech Republic, Federal Republic of Yugoslavia, Georgia, Hungary, Kazakhstan, Kirghizia, Former Yugoslav Republic of Macedonia (FYROM), Moldova, Poland, Romania, Russia, Slovak Republic, Slovenia, and Ukraine.

The following terms apply to the country specified:

EGYPT: Limitation of Liability: The following replaces item 2 in this Section:
2. as to any other actual direct damages, IBM's liability will be limited to the total amount you paid for the Machine that is the subject of the claim.

Applicability of suppliers and resellers (unchanged).

FRANCE: Limitation of Liability: The following replaces the second sentence of the first paragraph of this Section:
In such instances, regardless of the basis on which you are entitled to claim damages from IBM, IBM is liable for no more than: (items 1 and 2 unchanged).

GERMANY: The IBM Warranty for Machines: The following replaces the first sentence of the first paragraph of this Section:
The warranty for an IBM Machine covers the functionality of the Machine for its normal use and the Machine's conformity to its Specifications.

The following paragraphs are added to this Section:
The minimum warranty period for Machines is six months.

In case IBM or your reseller are unable to repair an IBM Machine, you can alternatively ask for a partial refund as far as justified by the reduced value of the unrepaired Machine or ask for a cancellation of the respective agreement for such Machine and get your money refunded.

Extent of Warranty: The second paragraph does not apply.

Warranty Service: The following is added to this Section:
During the warranty period, transportation for delivery of the failing Machine to IBM will be at IBM's expense.

Production Status: The following paragraph replaces this Section:
Each Machine is newly manufactured. It may incorporate in addition to new parts, re-used parts as well.

Limitation of Liability: The following is added to this Section:
The limitations and exclusions specified in the Statement of Warranty will not apply to damages caused by IBM with fraud or gross negligence and for express warranty.

In item 2, replace "U.S. \$100,000" with "1.000.000 DEM."

The following sentence is added to the end of the first paragraph of item 2:
IBM's liability under this item is limited to the violation of essential contractual terms in cases of ordinary negligence.

IRELAND: Extent of Warranty: The following is added to this Section:
Except as expressly provided in these terms and conditions, all statutory conditions, including all warranties implied, but without prejudice to the generality of the foregoing all warranties implied by the Sale of Goods Act 1893 or the Sale of Goods and Supply of Services Act 1980 are hereby excluded.

Limitation of Liability: The following replaces items one and two of the first paragraph of this Section:
1. death or personal injury or physical damage to your real property solely caused by IBM's negligence; and 2. the amount of any other actual direct damages, up to the

greater of Irish Pounds 75,000 or 125 percent of the charges (if recurring, the 12 months' charges apply) for the Machine that is the subject of the claim or which otherwise gives rise to the claim.

Applicability of suppliers and resellers (unchanged).

The following paragraph is added at the end of this Section:

IBM's entire liability and your sole remedy, whether in contract or in tort, in respect of any default shall be limited to damages.

ITALY: Limitation of Liability: The following replaces the second sentence in the first paragraph:

In each such instance unless otherwise provided by mandatory law, IBM is liable for no more than: (item 1 unchanged) 2) as to any other actual damage arising in all situations involving non-performance by IBM pursuant to, or in any way related to the subject matter of this Statement of Warranty, IBM's liability, will be limited to the total amount you paid for the Machine that is the subject of the claim.

Applicability of suppliers and resellers (unchanged).

The following replaces the second paragraph of this Section:

Unless otherwise provided by mandatory law, IBM and your reseller are not liable for any of the following: (items 1 and 2 unchanged) 3) indirect damages, even if IBM or your reseller is informed of their possibility.

SOUTH AFRICA, NAMIBIA, BOTSWANA, LESOTHO AND SWAZILAND:

Limitation of Liability: The following is added to this Section:

IBM's entire liability to you for actual damages arising in all situations involving nonperformance by IBM in respect of the subject matter of this Statement of Warranty will be limited to the charge paid by you for the individual Machine that is the subject of your claim from IBM.

TURKIYE: Production Status: The following replaces this Section:

IBM fulfills customer orders for IBM Machines as newly manufactured in accordance with IBM's production standards.

UNITED KINGDOM: Limitation of Liability: The following replaces items 1 and 2 of the first paragraph of this Section:

1. death or personal injury or physical damage to your real property solely caused by IBM's negligence; 2. the amount of any other actual direct damages or loss, up to the greater of Pounds Sterling 150,000 or 125 percent of the charges (if recurring, the 12 months' charges apply) for the Machine that is the subject of the claim or which otherwise gives rise to the claim.

The following item is added to this paragraph:

3. breach of IBM's obligations implied by Section 12 of the Sale of Goods Act 1979 or Section 2 of the Supply of Goods and Services Act 1982.

Applicability of suppliers and resellers (unchanged).

The following is added to the end of this Section:

IBM's entire liability and your sole remedy, whether in contract or in tort, in respect of any default will be limited to damages.

NORTH AMERICA

CANADA: Warranty Service: The following is added to this section:

To obtain warranty service from IBM, call **1-800-565-3344**.

UNITED STATES OF AMERICA: Warranty Service: The following is added to this section:

To obtain warranty service from IBM, call **1-800-772-2227**.

Notices

References in this publication to IBM products, programs, or services do not imply that IBM intends to make these available in all countries in which IBM operates. Any reference to an IBM product, program, or service is not intended to state or imply that only that IBM product, program, or service may be used. Subject to IBM's valid intellectual property or other legally protectable rights, any functionally equivalent product, program, or service may be used instead of the IBM product, program, or service. The evaluation and verification of operation in conjunction with other products, except those expressly designated by IBM, are the responsibility of the user.

IBM may have patents or pending patent applications covering subject matter in this document. The furnishing of this document does not give you any license to these patents. You can send license inquiries, in writing, to:

IBM Director of Licensing
IBM Corporation
North Castle Drive
Armonk, NY 10504-1785
U.S.A.

This section contains trademarks, electronic emission notices, and other important information.

Any references in this publication to non-IBM Web sites are provided for convenience only and do not in any manner serve as an endorsement of those Web sites. The materials at those Web sites are not part of the materials for this IBM product and use of those Web sites is at your own risk.

Edition Notice

INTERNATIONAL BUSINESS MACHINES CORPORATION PROVIDES THIS PUBLICATION "AS IS" WITHOUT WARRANTY OF ANY KIND, EITHER EXPRESS OR IMPLIED, INCLUDING, BUT NOT LIMITED TO, THE IMPLIED WARRANTIES OF MERCHANTABILITY OR FITNESS FOR A PARTICULAR PURPOSE. Some jurisdictions do not allow disclaimer of express or implied warranties in certain transactions, therefore, this statement may not apply to you.

This publication could include technical inaccuracies or typographical errors. Changes are periodically made to the information herein; these changes will be incorporated in new editions of the publication. IBM may make improvements and/or changes in the product(s) and/or the program(s) described in this publication at any time.

This publication was developed for products and services offered in the United States of America and the United Kingdom. It is possible that this publication may contain reference to, or information about, IBM products (machines and programs), programming, or services that are not announced in your country. Such references or information must not be construed to mean that IBM intends to announce such IBM products, programming, or services in your country.

Requests for technical information about IBM products should be made to your IBM reseller or IBM marketing representative. No part of this publication may be reproduced or distributed in any form or by any means without prior permission in writing from the International Business Machines Corporation.

© COPYRIGHT INTERNATIONAL BUSINESS MACHINES CORPORATION,
2000. All rights reserved.

Note to U.S. Government Users — Documentation related to restricted rights — Use, duplication or disclosure is subject to restrictions set forth in GSA ADP Schedule Contract with IBM Corp.

Year 2000 readiness and instructions

This is a Year 2000 Readiness Disclosure.

A product is Year 2000 Ready if the product, when used in accordance with its associated documentation, is capable of correctly processing, providing and/or receiving date data within and between the 20th and 21st centuries, provided all other products (for example, software, hardware, and firmware) used with the product properly exchange date data with it.

This IBM PC hardware product has been designed to process four-digit date information correctly within and between the 20th and 21st centuries. If your IBM computer is on when the century changes, you should turn it off and then back on again once, or restart the operating system, to ensure that the internal clock resets itself for the new century.

This IBM PC product cannot prevent errors that might occur if software you use or exchange data with is not ready for the Year 2000. IBM software that comes with this product is Year 2000 Ready. However, software from other companies might come with this IBM PC product. IBM cannot take responsibility for the readiness of that software. You should contact the software developers directly if you wish to verify readiness, understand limitations, or look for any software updates.

To learn more about IBM PC products and the Year 2000, visit our Web site at <http://www.ibm.com/pc/year2000>. The information and tools there can help you with your Year 2000 transition plan, especially if you have multiple IBM PCs. IBM encourages you to check periodically for updated information.

Trademarks

The following terms are trademarks of the IBM Corporation in the United States or other countries or both:

Alert on LAN	OS/2 Warp
Aptiva	PC Server
Chipkill	PC 300
DB2	Predictive Failure Analysis
EtherJet	ServeRAID
HelpCenter	ServerGuide
HelpWare	ServerProven
IBM	SurePath
IntelliStation	TechConnect
Netfinity	ThinkPad
Netfinity Advanced System Management	Update Connector
Netfinity Manager	ValuePoint
OS/2	Wake on LAN

Lotus and Domino are trademarks of Lotus Development Corporation in the United States, other countries, or both.

Tivoli and NetView are trademarks of Tivoli Systems Inc. in the United States, other countries, or both.

Intel, MMX, LANDesk, Pentium, Pentium II Xeon, and Pentium III Xeon are trademarks or registered trademarks of Intel Corporation in the United States, other countries, or both.

Microsoft, Windows, and Windows NT are trademarks or registered trademarks of Microsoft Corporation.

UNIX is a registered trademark in the United States and other countries and is licensed exclusively through The Open Group.

Java and all Java-based trademarks and logos are trademarks or registered trademarks of Sun Microsystems, Inc. in the United States, other countries, or both.

Other company, product, and service names may be trademarks or service marks of others.

Important notes

Processor speeds indicate the internal clock speed of the microprocessor; other factors also affect application performance.

When referring to hard disk drive capacity, MB stands for 1 000 000 bytes and GB stands for 1 000 000 000 bytes. Total user-accessible capacity may vary depending on operating environments.

Maximum internal hard disk drive capacities assume the replacement of any standard hard disk drives and population of all hard disk drive bays with the largest currently supported drives available from IBM.

Unless otherwise stated, IBM makes no representations or warranties with respect to non-IBM products. Support (if any) for the non-IBM products is provided by the third party, not IBM.

Some software may differ from its retail version (if available), and may not include user manuals or all program functionality.

Electronic emission notices

Federal Communications Commission (FCC) Statement

Federal Communications Commission (FCC) Class A Statement

Note: This equipment has been tested and found to comply with the limits for a Class A digital device, pursuant to Part 15 of the FCC Rules. These limits are designed to provide reasonable protection against harmful interference when the equipment is operated in a commercial environment. This equipment generates, uses, and can radiate radio frequency energy and, if not installed and used in accordance with the instruction manual, may cause harmful interference to radio communications. Operation of this equipment in a residential area is likely to cause harmful interference, in which case the user will be required to correct the interference at his own expense.

Properly shielded and grounded cables and connectors must be used in order to meet FCC emission limits. IBM is not responsible for any radio or television interference caused by using other than recommended cables and connectors or by unauthorized changes or modifications to this equipment. Unauthorized changes or modifications could void the user's authority to operate the equipment.

This device complies with Part 15 of the FCC Rules. Operation is subject to the following two conditions: (1) this device may not cause harmful interference, and (2) this device must accept any interference received, including interference that may cause undesired operation.

Industry Canada Class A emission compliance statement

Canadian Department of Communications Compliance Statement

This digital apparatus does not exceed the Class A limits for radio noise emissions from digital apparatus as set out in the interference-causing equipment standard entitled *Digital Apparatus*, ICES-003 of the Department of Communications.

Avis de conformité aux normes du ministère des Communications du Canada

Cet appareil numérique respecte les limites de bruits radioélectriques applicables aux appareils numériques de Classe A prescrites dans la norme sur le matériel brouiller: *Appareils Numériques*, NMB-003 édictée par le ministre des Communications.

Australia and New Zealand Class A statement

Attention: This is a Class A product. In a domestic environment this product may cause radio interference in which case the user may be required to take adequate measures.

United Kingdom telecommunications safety requirement

Notice to Customers

This apparatus is approved under approval number NS/G/1234/J/100003 for indirect connection to public telecommunication systems in the United Kingdom.

European community directive conformance statement

This product is in conformity with the protection requirements of EC Council Directive 89/336/EEC on the approximation of the laws of the Member States relating to electro-magnetic compatibility.

Attention: This is a Class A product. In a domestic environment this product may cause radio interference in which case the user may be required to take adequate measures.

Taiwan electrical emission statement

警告使用者：
這是甲類的資訊產品，在
居住的環境中使用時，可
能會造成射頻干擾，在這
種情況下，使用者會被要
求採取某些適當的對策。

Japanese Voluntary Control Council for Interference (VCCI) statement

この装置は、情報処理装置等電波障害自主規制協議会（VCCI）の基準に基づくクラスA情報技術装置です。この装置を家庭環境で使用すると電波妨害を引き起こすことがあります。この場合には使用者が適切な対策を講ずるよう要求されることがあります。

Power cords

For your safety, IBM provides a power cord with a grounded attachment plug to use with this IBM product. To avoid electrical shock, always use the power cord and plug with a properly grounded outlet.

IBM power cords used in the United States and Canada are listed by Underwriter's Laboratories (UL) and certified by the Canadian Standards Association (CSA).

For units intended to be operated at 115 volts: Use a UL-listed and CSA-certified cord set consisting of a minimum 18 AWG, Type SVT or SJT, three-conductor cord, a maximum of 15 feet in length and a parallel blade, grounding-type attachment plug rated 15 amperes, 125 volts.

For units intended to be operated at 230 volts (U.S. use): Use a UL-listed and CSA-certified cord set consisting of a minimum 18 AWG, Type SVT or SJT, three-conductor cord, a maximum of 15 feet in length and a tandem blade, grounding-type attachment plug rated 15 amperes, 250 volts.

For units intended to be operated at 230 volts (outside the U.S.): Use a cord set with a grounding-type attachment plug. The cord set should have the appropriate safety approvals for the country in which the equipment will be installed.

IBM power cords for a specific country or region are usually available only in that country or region.

IBM power cord part number	Used in these countries and regions
13F9940	Argentina, Australia, China (PRC), New Zealand, Papua New Guinea, Paraguay, Uruguay, Western Samoa
13F9979	Afghanistan, Algeria, Andorra, Angola, Austria, Belgium, Benin, Bulgaria, Burkina Faso, Burundi, Cameroon, Central African Rep., Chad, Czech Republic, Egypt, Finland, France, French Guiana, Germany, Greece, Guinea, Hungary, Iceland, Indonesia, Iran, Ivory Coast, Jordan, Lebanon, Luxembourg, Macau, Malagasy, Mali, Martinique, Mauritania, Mauritius, Monaco, Morocco, Mozambique, Netherlands, New Caledonia, Niger, Norway, Poland, Portugal, Romania, Senegal, Slovakia, Spain, Sudan, Sweden, Syria, Togo, Tunisia, Turkey, former USSR, Vietnam, former Yugoslavia, Zaire, Zimbabwe
13F9997	Denmark
14F0015	Bangladesh, Burma, Pakistan, South Africa, Sri Lanka
14F0033	Antigua, Bahrain, Brunei, Channel Islands, Cyprus, Dubai, Fiji, Ghana, Hong Kong, India, Iraq, Ireland, Kenya, Kuwait, Malawi, Malaysia, Malta, Nepal, Nigeria, Polynesia, Qatar, Sierra Leone, Singapore, Tanzania, Uganda, United Kingdom, Yemen, Zambia
14F0051	Liechtenstein, Switzerland
14F0069	Chile, Ethiopia, Italy, Libya, Somalia
14F0087	Israel
1838574	Thailand
62X1045	Bahamas, Barbados, Bermuda, Bolivia, Brazil, Canada, Cayman Islands, Colombia, Costa Rica, Dominican Republic, Ecuador, El Salvador, Guatemala, Guyana, Haiti, Honduras, Jamaica, Japan, Korea (South), Liberia, Mexico, Netherlands Antilles, Nicaragua, Panama, Peru, Philippines, Saudi Arabia, Suriname, Taiwan, Trinidad (West Indies), United States of America, Venezuela

Index

A

acoustical noise emissions 2
adapter
 installing 7
adapters 7

B

beep codes 23

C

CD-ROM 2
Class A electronic emission notice
 42
components
 color 4
 major 4
Configuration/Setup Utility program 21
configuring your server 21

D

diskette drive 2
documentation CD 1

E

electrical input 2
electronic emission Class A notice
 42
environment 2
error messages
 POST 24
Ethernet link status light 20
Ethernet transmit/receive activity
 light 20

F

FCC Class A notice 42

H

heat output 2
hot-swap drive 12
 specifications 2

I

important notes 42
information LED panel 19
information light 20

L

LEDs
 front of server 20
 hard disk drive 20

M

major components 4
memory 10
 installing 10
 specifications 2
microprocessor 13
 specifications 2

N

non-hot-swap drive
 specifications 2
NOS See operating system
notices
 electronic emission, Class A 42
 FCC, Class A 42
 miscellaneous 42
 product 42
 trademarks 41

O

operating system, installing 21

P

PCI expansion slots 2
power control button 18
power cords 44
power supply
 installing 14
 specifications 2
problems, solving 23
product
 notices 42

R

reset button 18

S

safety information
 electrical vii, x
 laser products viii
 lifting server 15
safety requirements
 electronic emission Class A notice 42
 FCC Class A notice 42
SCSISelect Utility program 21
ServeRAID Configuration program 21
ServerGuide
 CDs 21
 error symptoms 26
size 2
specifications 2
system error light 20
system power light 20
systems management 22

T

trademarks 41
troubleshooting chart 27
turning off the server 18

U

United States electronic emission
 Class A notice 42
United States FCC Class A notice 42

V

video 2
voltage regulator module 13
VRM 13

W

Web site 1
weight 2
working with the server with the
 power on 7

Y

year 2000 readiness and instructions
 41



Part Number: 09N8216



Printed in the United States of America
on recycled paper containing 10%
recovered post-consumer fiber.

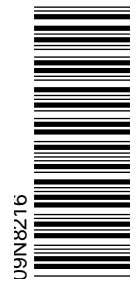

SC09-N821-60

