



Console Switch

Installation and User's Guide

For 17351LX and 17352LX



Console Switch Installation and User's Guide

Safety

Before installing this product, read the Safety Information.

قبل تركيب هذا المنتج، يجب قراءة الملاحظات الأمنية

Antes de instalar este produto, leia as Informações de Segurança.

在安装本产品之前，请仔细阅读 **Safety Information** (安全信息)。

安裝本產品之前，請先閱讀「安全資訊」。

Prije instalacije ovog produkta obavezno pročitajte Sigurnosne Upute.

Před instalací tohoto produktu si přečtěte příručku bezpečnostních instrukcí.

Læs sikkerhedsforskrifterne, før du installerer dette produkt.

Lees voordat u dit product installeert eerst de veiligheidsvoorschriften.

Ennen kuin asennat tämän tuotteen, lue turvaohjeet kohdasta Safety Information.

Avant d'installer ce produit, lisez les consignes de sécurité.

Vor der Installation dieses Produkts die Sicherheitshinweise lesen.

Πριν εγκαταστήσετε το προϊόν αυτό, διαβάστε τις πληροφορίες ασφαλείας (safety information).

לפני שתתקינו מוצר זה, קראו את הוראות הבטיחות.

A termék telepítése előtt olvassa el a Biztonsági előírásokat!

Prima di installare questo prodotto, leggere le Informazioni sulla Sicurezza.

製品の設置の前に、安全情報をお読みください。

본 제품을 설치하기 전에 안전 정보를 읽으십시오.

Пред да се инсталира овој продукт, прочитајте информацијата за безбедност.

Les sikkerhetsinformasjonen (Safety Information) før du installerer dette produktet.

Przed zainstalowaniem tego produktu, należy zapoznać się z książką "Informacje dotyczące bezpieczeństwa" (Safety Information).

Antes de instalar este produto, leia as Informações sobre Segurança.

Перед установкой продукта прочтите инструкции по технике безопасности.

Pred inštaláciou tohto zariadenia si pečítajte Bezpečnostné predpisy.

Pred namestitvijo tega proizvoda preberite Varnostne informacije.

Antes de instalar este producto, lea la información de seguridad.

Läs säkerhetsinformationen innan du installerar den här produkten.

Notices and Statements Used in This Document

- **Note:** These notices provide important tips, guidance, or advice.
- **Important:** These notices provide important information or advice that might help you avoid inconvenient or problem situations.
- **Attention:** These notices indicate possible damage to programs, devices or data. An attention notice is placed just before the instruction or situation in which damage could occur.
- **Caution:** These statements indicate situations that can be potentially hazardous to you. A caution situation is placed just before the description of a potentially hazardous procedure step or situation.
- **Danger:** These statements indicate situations that can be potentially lethal or extremely hazardous to you. A danger statement is placed just before the description of a potentially lethal or extremely hazardous procedure step or situation.

Important:

All caution and danger statements in this documentation begin with a number. This number is used to cross reference an English caution or danger statement with translated versions of the caution or danger statement in the IBM Safety Information book.

For example, if a caution statement begins with a number 1, translations for that caution statement appear in the IBM Safety Information book under statement 1.

Be sure to read all caution and danger statements in this documentation before performing the instructions. Read any additional safety information that comes with your server or optional device before you install the device.

Statement 1



DANGER

Electrical current from power, telephone, and communication cables is hazardous.

To avoid a shock hazard:

- Do not connect or disconnect any cables or perform installation, maintenance, or reconfiguration of this product during an electrical storm.
- Connect all power cords to a properly wired and grounded electrical outlet.
- Connect to properly wired outlets any equipment that will be attached to this product.
- When possible, use one hand only to connect or disconnect signal cables.
- Never turn on any equipment when there is evidence of fire, water, or structural damage.
- Disconnect the attached power cords, telecommunications systems, networks, and modems before you open the device covers, unless instructed otherwise in the installation and configuration procedures.
- Connect and disconnect cables as described in the following table when installing, moving, or opening covers on this product or attached devices.

To Connect:

1. Turn everything OFF.
2. First, attach all cables to devices.
3. Attach signal cables to connectors.
4. Attach power cords to outlet.
5. Turn device ON.

To Disconnect:

1. Turn everything OFF.
2. First, remove power cords from outlet.
3. Remove signal cables from connectors.
4. Remove all cables from devices.

Statement 8:



CAUTION:

Never remove the cover on a power supply or any part that has the following label attached.



Hazardous voltage, current, and energy levels are present inside any component that has this label attached. There are no serviceable parts inside these components. If you suspect a problem with one of these parts, contact a service technician.

TABLE OF CONTENTS

List of Figures	xi
List of Tables	xiii
Chapter 1: Product Overview	1
<i>Features and Benefits</i>	<i>1</i>
<i>Switch Cable</i>	<i>1</i>
<i>Safety Precautions</i>	<i>4</i>
<i>Rack Mounting of Systems</i>	<i>7</i>
Chapter 2: Installation	9
<i>Getting Started</i>	<i>9</i>
<i>Supplied with the console switch</i>	<i>9</i>
<i>Rack Mounting the Console Switch</i>	<i>9</i>
<i>Vertical installation in the side of a rack</i>	<i>9</i>
<i>Horizontal installation in the 1 U rack mounting space</i>	<i>10</i>
<i>Installing the Console Switch</i>	<i>11</i>
<i>Tiering Multiple Console Switches</i>	<i>13</i>
<i>Adding Earlier-model Switches</i>	<i>14</i>
<i>Configuring the Console Switch System</i>	<i>16</i>
Chapter 3: Basic Operations	17
<i>Controlling the System at the Local Ports</i>	<i>17</i>
<i>Viewing and Selecting Ports and Servers</i>	<i>17</i>
<i>Selecting servers</i>	<i>19</i>
<i>Navigating the OSCAR Interface</i>	<i>20</i>
<i>Configuring OSCAR Interface Menus</i>	<i>21</i>
<i>Assigning server names</i>	<i>22</i>
<i>Assigning device types</i>	<i>23</i>
<i>Changing the display behavior</i>	<i>25</i>
<i>Controlling the status flag</i>	<i>26</i>
<i>Setting console switch security</i>	<i>28</i>
<i>Displaying Version Information</i>	<i>30</i>
<i>Resetting the Keyboard and Mouse</i>	<i>32</i>

<i>Scanning the System</i>	32
<i>Broadcasting to Servers</i>	34
<i>Changing the Switch Mode</i>	36
<i>Setting the Keyboard Country Code</i>	37
Appendices	39
<i>Appendix A: Firmware Upgrades</i>	39
<i>Appendix B: Technical Specifications</i>	41
<i>Appendix C: Notices</i>	42
<i>Appendix D: Electronic Emission Notices</i>	44
Index	47

LIST OF FIGURES

<i>Figure 1.1: PS/2 Switch Cable and USB Switch Cable</i>	2
<i>Figure 1.2: Example of a Console Switch Configuration</i>	4
<i>Figure 2.1: Console Switch vertical installation</i>	10
<i>Figure 2.2: Console Switch Horizontal Installation</i>	11
<i>Figure 2.3: Basic Console Switch Configuration</i>	12
<i>Figure 2.4: Console Switch Configuration with a Tiered Switch</i>	13
<i>Figure 2.5: Console Switch Configuration with an Earlier-model Switch</i>	15
<i>Figure 3.1: Example of Configured Main Window</i>	18
<i>Figure 3.2: Setup Window</i>	22
<i>Figure 3.3: Names Window</i>	22
<i>Figure 3.4: Name Modify Window</i>	23
<i>Figure 3.5: Devices Window</i>	24
<i>Figure 3.6: Device Modify Window</i>	24
<i>Figure 3.7: Menu Window</i>	25
<i>Figure 3.8: Flag Window</i>	27
<i>Figure 3.9: Set Position Window</i>	27
<i>Figure 3.10: Security Window</i>	28
<i>Figure 3.11: Version Window</i>	30
<i>Figure 3.12: Cable Selection Window</i>	31
<i>Figure 3.13: Cable Version Window</i>	31
<i>Figure 3.14: Scan Window</i>	33
<i>Figure 3.15: Commands Window</i>	34
<i>Figure 3.16: Broadcast Window</i>	35
<i>Figure 3.17: Broadcast Enable Window</i>	36
<i>Figure 3.18: Switch Window</i>	37
<i>Figure 3.19: Keyboard Window</i>	37
<i>Figure 3.20: Keyboard Warning Window</i>	38

LIST OF TABLES

<i>Table 1.1: Console Switch Cable Resolution and Refresh Rate</i>	<i>2</i>
<i>Table 2.1: Earlier-model Switches</i>	<i>14</i>
<i>Table 3.1: OSCAR Interface Status Symbols</i>	<i>18</i>
<i>Table 3.2: OSCAR Interface Navigation Basics</i>	<i>20</i>
<i>Table 3.3: Setup Features to Manage Routine Tasks for the Servers</i>	<i>21</i>
<i>Table 3.4: OSCAR Interface Status Flags</i>	<i>26</i>

Product Overview

Features and Benefits

The IBM 1x8 Console Switch and the IBM 2x16 Console Switch integrate keyboard, video, and mouse (KVM) switching technology with advanced cable management, flexible access for up to two simultaneous users, and an intuitive user interface. The console switches feature powerful on-screen management for easy system configuration and server selection.

NOTE: The 1x8 console switch enables a single local user to access any attached servers. The 2x16 console switch enables two simultaneous users to access attached servers.

The IBM 3M Console Switch Cables (PS/2 and USB) are unique benefits of the console switch. By using CAT 5 cabling, the switch cable reduces cable clutter, while providing optimal resolution and video settings. The built-in memory of the switch cable simplifies configuration by assigning and retaining unique server names and port numbers for each attached server. The switch cable is powered directly from the server and provides Keep Alive functionality even if the console switch is not turned on. Keep Alive functionality enables the server to operate properly with or without connectivity to the console switch.

Switch Cable

The switch cable enables direct KVM connectivity to servers attached to the console switch. The 1x8 console switch has 8 Analog Rack Interface (ARI) ports and the 2x16 console switch has 16 ARI ports for connecting switch cables.

Using a PS/2 switch cable you can attach additional switches to expand the console switch system. This flexibility enables you to add capacity as the data center grows.

Multiplatform Support

The switch cables available with the console switch support PS/2 and USB server environments. Using the On-Screen Configuration and Activity Reporting (OSCAR[®]) graphical user interface in conjunction with these cables enables you to switch easily across platforms.

The PS/2 switch cable is used to connect a PS/2 server to a console switch. This cable has one HD15 connector for video, one PS/2 connector for keyboard, and one PS/2 connector for mouse.

The USB switch cable is used to connect a USB server to a console switch. This cable has one HD15 connector for video and one USB connector for keyboard and mouse.

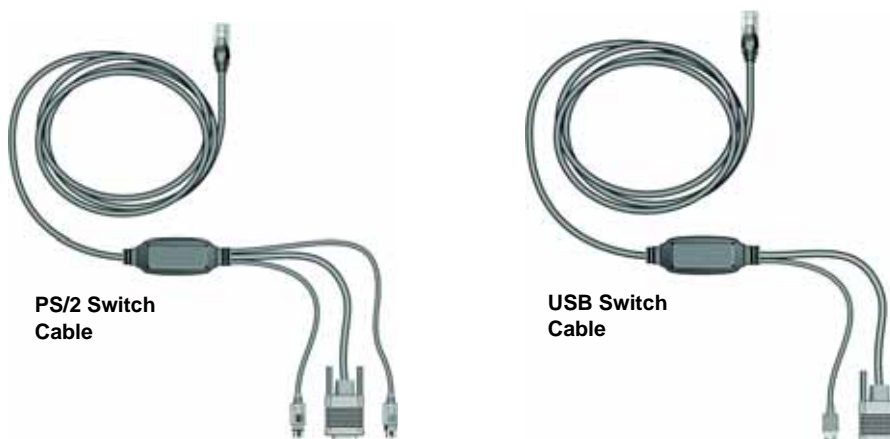

Figure 1.1: PS/2 Switch Cable and USB Switch Cable

OSCAR Graphical User Interface

The console switch uses the OSCAR interface, which features intuitive menus to configure the switch system and select servers. Servers can be identified by a unique name and port number, enabling you to assign a unique server name.

Security

The OSCAR interface enables you to protect the system with a screen saver password. After a user-defined time, the screen saver mode engages, and access is prohibited until the appropriate password is entered to reactivate the system.

Video

The console switch provides optimal resolutions for analog VGA, SVGA, and XGA video. You can achieve resolutions up to 1280 x 1024 with a 3-m (9.8-ft) cable.

Table 1.1: Console Switch Cable Resolution and Refresh Rate

Maximum Resolution	Refresh Rate	Video Type
720 x 400	70 Hz	VGA
640 x 480	60 Hz	VGA
640 x 480	72 Hz	VESA
640 x 480	75 Hz	VESA

Table 1.1: Console Switch Cable Resolution and Refresh Rate

800 x 600	56 Hz	VESA
800 x 600	60 Hz	VESA
800 x 600	72 Hz	VESA
800 x 600	75 Hz	VESA
1024 x 768	60 Hz	VESA
1024 x 768	70 Hz	VESA
1280 x 1024	75 Hz	VGA

Plug and Play

The console switch also supports Display Data Channel (DDC) Plug and Play, which automates configuration of the monitor and is compliant with the VESA DDC2B standard.

Firmware Upgrades

You can upgrade the firmware at any time through an update utility to be sure that the console switch system is always running the most current version available. See “Appendix A: Firmware Upgrades” for more information.

Tiering Expansion

The 1x8 console switch supports up to 8 directly attached servers and the 2x16 console switch supports up to 16 directly attached servers. Each model can conveniently scale to support additional servers. You can expand the system by tiering with console switches and earlier-model console switches. This extra tier of units enables you to attach up to 256 servers in one system. See “Tiering Console Switches” in Chapter 2 for more information.

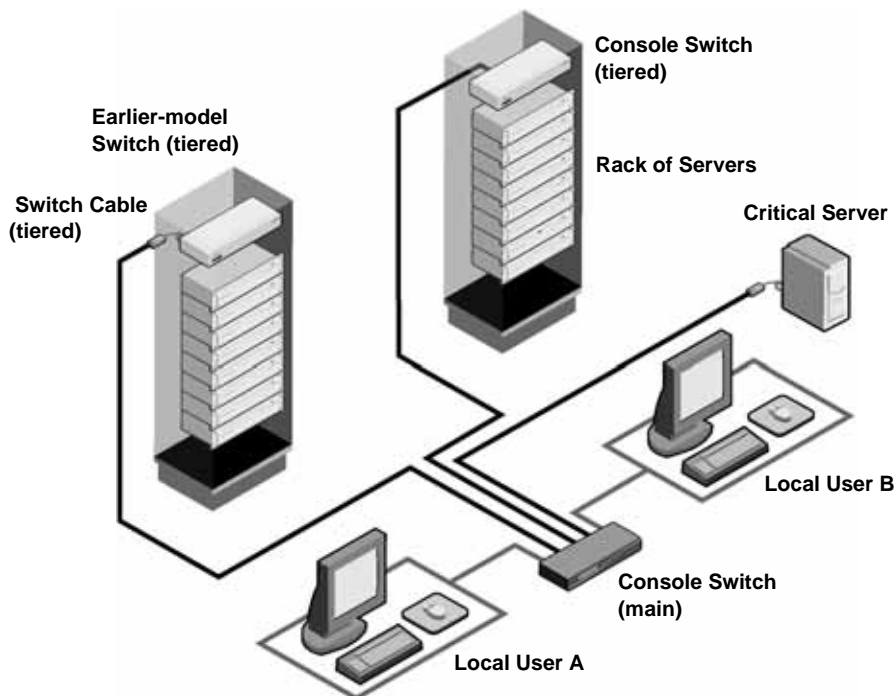

Figure 1.2: Example of a Console Switch Configuration

Safety Precautions

Use the following safety guidelines to help ensure your own personal safety and to help protect the system and working environment from potential damage.

Statement 1

**DANGER**

Electrical current from power, telephone, and communication cables is hazardous.

To avoid a shock hazard:

- Do not connect or disconnect any cables or perform installation, maintenance, or reconfiguration of this product during an electrical storm.
- Connect all power cords to a properly wired and grounded electrical outlet.
- Connect to properly wired outlets any equipment that will be attached to this product.
- When possible, use one hand only to connect or disconnect signal cables.
- Never turn on any equipment when there is evidence of fire, water, or structural damage.
- Disconnect the attached power cords, telecommunications systems, networks, and modems before you open the device covers, unless instructed otherwise in the installation and configuration procedures.
- Connect and disconnect cables as described in the following table when installing, moving, or opening covers on this product or attached devices.

To Connect:

1. Turn everything OFF.
2. First, attach all cables to devices.
3. Attach signal cables to connectors.
4. Attach power cords to outlet.
5. Turn device ON.

To Disconnect:

1. Turn everything OFF.
2. First, remove power cords from outlet.
3. Remove signal cables from connectors.
4. Remove all cables from devices.

Statement 8:



CAUTION:

Never remove the cover on a power supply or any part that has the following label attached.



Hazardous voltage, current, and energy levels are present inside any component that has this label attached. There are no serviceable parts inside these components. If you suspect a problem with one of these parts, contact a service technician.

General

- Observe and follow service markings.
- Do not service any console switch except as explained in the console switch documentation.
- Opening or removing covers that are marked with the triangular symbol with a lightning bolt might expose you to electrical shock.
- Components inside these compartments should be serviced only by a trained service technician.
- The console switch contains no serviceable components. Do not attempt to open.
- If any of the following conditions occur, unplug the console switch from the electrical outlet and replace the part or contact the trained service provider:
 - The power cable, extension cable, or plug is damaged.
 - An object has fallen into the product.
 - The console switch has been exposed to water.
 - The console switch has been dropped or damaged.
 - The console switch does not operate correctly when you follow the operating instructions.
- Keep the console switch away from radiators and heat sources. Also, do not block cooling vents.
- Do not spill food or liquids on the console switch components, and never operate the console switch in a wet environment. If the console switch gets wet, see the appropriate section in the troubleshooting guide or contact the trained service provider.
- Use the console switch only with approved equipment.
- Enable the console switch to cool before removing covers or touching internal components.
- Operate the console switch only from the type of external power source indicated on the electrical ratings label. If you are not sure of the type of power source required, consult the service provider or local power company.

- Be sure that the monitor and attached devices are electrically rated to operate with the power available in your location.
- Use only power cables provided with the console switch.
- To help prevent electric shock, plug the console switch and peripheral power cables into properly grounded electrical outlets. These cables are equipped with three-prong plugs to help ensure proper grounding. Do not use adapter plugs or remove the grounding prong from a cable.
- Observe extension cable and power strip ratings. Make sure that the total ampere rating of all products plugged into the power strip does not exceed 80 percent of the ampere ratings limit for the power strip.
- To help protect the console switch from sudden, transient increases and decreases in electrical power, use a surge suppressor, line conditioner, or uninterruptible power supply.
- Position console switch cables and power cables carefully. Route cables so that they cannot be stepped on or tripped over. Be sure that nothing rests on any cables.
- Do not modify power cables or plugs. Consult a licensed electrician or the power company for site modifications. Always follow the local and national wiring rules.

Rack Mounting of Systems

- Refer to the rack installation documentation accompanying the rack for specific caution statements and procedures.
- Elevated ambient temperature: If installed in a closed rack assembly, the operation temperature of the rack environment can be greater than room ambient. Use care not to exceed the rated maximum ambient temperature of the unit.
- Reduced air flow: Carefully install the equipment in a rack so that an adequate amount of airflow is maintained for safe operation of the equipment.
- Mechanical loading: Avoid a potentially hazardous condition caused by uneven mechanical loading by carefully mounting the equipment in the rack.
- Circuit overloading: Consideration should be given to the connection of the equipment to the supply circuit and the effect that overloading of circuits might have on overcurrent protection and supply wiring. Consider equipment nameplate ratings for maximum current.
- Reliable earthing: Reliable earthing of rack-mounted equipment should be maintained. Pay particular attention to supply connections other than direct connections to the branch circuit (for example, use of power strips).

Getting Started

Before installing the console switch, refer to the following list to ensure you have all of the items that were shipped with the console switch as well as other items necessary for proper installation.

Supplied with the console switch

- Console switch
- Power cord
- Rack mounting hardware (includes rack mounting brackets)
- Documentation CD
- Quick Installation Guide
- 1U filler panel

Additional items needed

- One IBM 3M Console Switch Cable (PS/2 or USB) per attached server
- One IBM 3M Console Switch Cable (PS/2) per attached switch
- One Phillips screwdriver

Rack Mounting the Console Switch

Before installing the console switch and other components in the rack (if not already installed), stabilize the rack in a permanent location. Install the equipment starting at the bottom of the rack, then work to the top. Avoid uneven loading or overloading of racks.

Vertical installation in the side of a rack

1. Remove the screws on each side of the console switch.
2. Line up the small holes of the L-shaped brackets with the screw holes in the switch.
3. With a Phillips screwdriver, fasten the mounting brackets to the switch using two 8/32" x 1/2" pan-head screws on each side.

4. Mount the switch assembly to the rack by matching the long slots on each bracket to an appropriate set of holes on the rack. Next, insert a combination hex head screw through the slots in the bracket and the holes in the rack. Cap the screw with a hex serrated flange nut and tighten.

NOTE: The mounting holes on the upper and lower side braces in a rack side compartment must be between 50.8 cm (20.0 in.) and 57.3 cm (22.6 in.) apart. If the rack has movable side braces, refer to the rack documentation for information about relocating side braces if they are not already spaced for this installation.

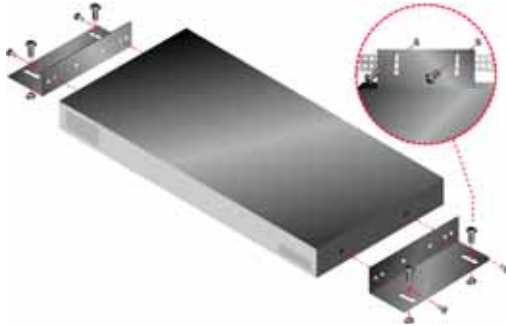

Figure 2.1: Console Switch vertical installation

Horizontal installation in the 1 U rack mounting space

NOTE: The filler panel must be placed in front of the rack when the console switch is mounted in the horizontal 1 U orientation.

1. Remove the screws on each side of the console switch.
2. Line up the holes in the long side of each mounting bracket.
3. With a Phillips screwdriver, fasten the mounting brackets to the switch using two 8/32" x 1/2" pan-head screws on each side.
4. Attach four cage nuts or clip nuts to the rack mounting flange of the rack so that the nut is positioned on the inside of the rack.
5. Mount the switch assembly to the rack by matching the holes in the short side of each mounting bracket to an appropriate set of matching holes on the rack. Insert the combination hex-head screws through the slots in the mounting bracket and the holes in the mounting rail, then into the cage nuts or clip nuts.

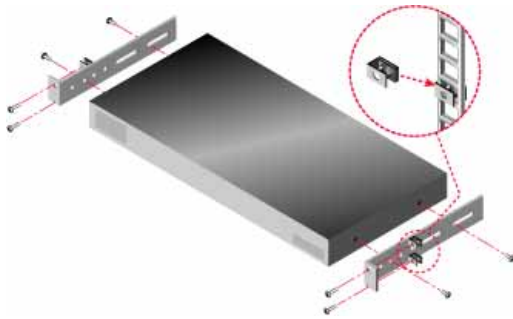

Figure 2.2: Console Switch Horizontal Installation

Installing the Console Switch

Connect the supplied power cord into the back of the console switch and then into an appropriate power source. Figure 2.3 illustrates one possible configuration for the console switch. See the following detailed set of procedures to successfully install the console switch.

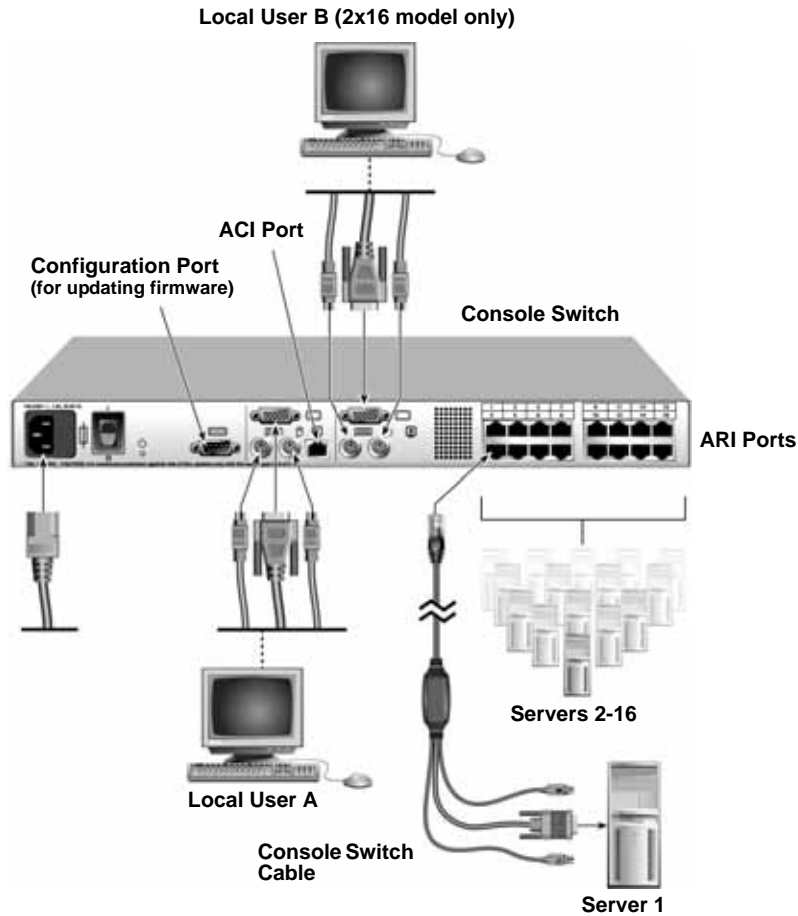

Figure 2.3: Basic Console Switch Configuration

Connecting a switch cable to a server

1. Locate the switch cable for the console switch.
2. Attach the appropriately color-coded cable ends to the keyboard, monitor, and mouse ports on the first server you will be connecting to the console switch.
3. Connect the RJ-45 connector on the PS/2 or USB switch cable to an Analog Rack Interface (ARI) port on the back of the console switch.
4. Repeat steps 2 to 4 for all servers you want to attach.

Connecting local peripheral devices

1. Select the keyboard, monitor, and mouse to be connected to local user A.

2. Locate the port set labeled A on the back of the console switch. Connect these peripheral devices to their respective ports.
3. Repeat these steps for the local port set labeled B (2x16 only).
4. Bundle and label the cables for easy identification.

Tiering Multiple Console Switches

You can tier multiple console switches to enable one or two users to connect to up to 256 servers. In a tiered system, each ARI port on the main console switch will connect to the Analog Console Interface (ACI) port on each tiered console switch. Each tiered switch can then be connected to up to 8 servers on the 1x8 console switch and up to 16 servers on the 2x16 console switch. The example in Figure 2.4 shows one console switch tiered under the main switch, enabling the connection of up to 15 primary servers and 16 secondary servers. In this configuration, you could tier 16 console switches under the main switch, enabling the connection of up to 256 servers. Only one level of tiering is supported in this type of configuration, which means that you cannot tier additional earlier-model switches or another console switch. In this configuration, the tiered local port On-screen Configuration and Activity Reporting (OSCAR) interface is disabled when the main console switch is tiered below another console switch.

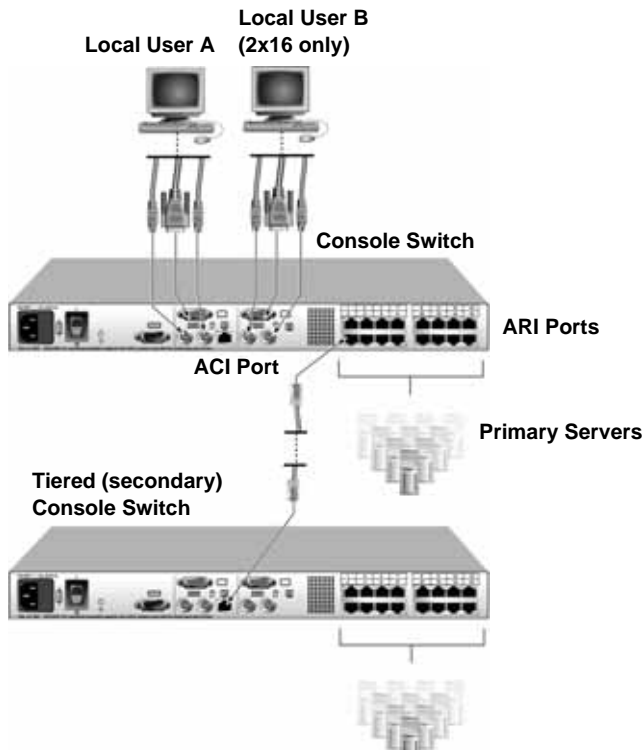

Figure 2.4: Console Switch Configuration with a Tiered Switch

NOTE: As shown in Figure 2.4, only the local user A has an ACI port that can be used for the tiered connection.

1. Connect the tiered console switch to each server as described in the previous “Installing the Console Switch” section.
 2. Connect the peripheral devices to local user A of the main switch as described in “Connecting local peripheral devices.”
 3. Attach one end of the CAT 5 cable that will connect the main and tiered console switch to the RJ-45 (ACI) connector of local user A on the tiered console switch.
 4. Attach the other end of the CAT 5 cable to one of the 16 RJ-45 (ARI) ports on the main console switch.
-

NOTE: The system will automatically tier the two switches together as one. All servers connected to the tiered console switch will display on the main console switch server list in the OSCAR interface.

5. Repeat steps 3 and 4 for all additional (secondary) tiered console switches you want to attach.

Adding Earlier-model Switches

You can add earlier-model switches for easy integration into the existing configuration. In a tiered system, each ARI port will accommodate up to 16 servers. When earlier-model switches are tiered under the 1x8 console switch or the 2x16 console switch, the console switch must be at the top level of the tier. See the following table for earlier-model switches compatible with the console switch configuration.

Table 2.1: Earlier-model Switches

Earlier-model Switch	Option Part Number
NetBAY™ 1x4 Console Switch	09N4290
NetBAY 2x8 Console Switch	09N4291

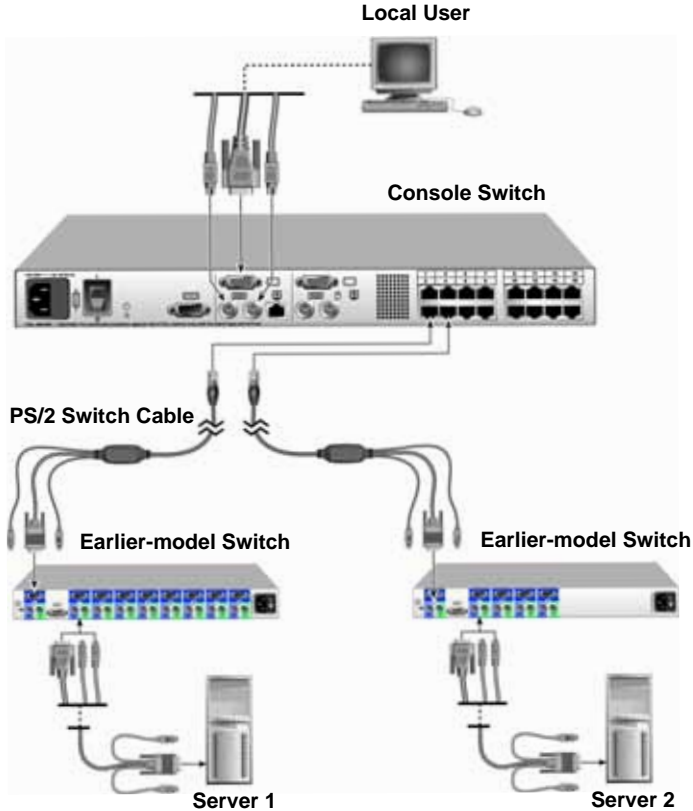

Figure 2.5: Console Switch Configuration with an Earlier-model Switch

1. Mount the earlier-model switch into the rack according to the instructions included with that device.
2. Attach the keyboard, monitor, and mouse connectors of the switch cable to the local port on the tiered switch.
3. Connect the RJ-45 connector on the PS/2 switch cable to an ARI port on the back of the console switch.
4. Connect the servers to the tiered switch according to the instructions included with that device.
5. Power cycle the tiered switch to enable its local port to recognize the switch cable.
6. Repeat steps 2 to 5 for all tiered switches you want to attach to the system.

Connecting local peripheral devices

1. Select the keyboard, monitor, and mouse to be connected to local user A.

2. Locate the port set labeled A on the back of the console switch. Connect these peripherals devices to their respective ports.
3. For the 2x16 console switch, repeat steps 1 and 2 for the local port set labeled B.
4. Bundle and label the cables for easy identification.

Configuring the Console Switch System

With the console switch system, you can auto detect and configure each port on the console switch. Chapter 3 provides detailed instructions about naming customization and OSCAR interface setup and configuration.

Basic Operations

Controlling the System at the Local Ports

The console switch features two local port sets on the back of the unit that enable you to connect a monitor and a PS/2 keyboard and mouse for direct local access. The 1x8 console switch enables you to connect a single local user, whereas the 2x16 console switch enables you to connect two users. The console switch uses the OSCAR interface, which uses intuitive menus to configure the system and select servers.

Viewing and Selecting Ports and Servers

Use the OSCAR Main window to view, configure, and control servers directly connected to the console switch. View the servers by name or port. You will see an OSCAR interface-generated port list by default when you first launch the OSCAR interface.

The Port column indicates the ARI port to which a server is connected. If you connect an earlier-model switch to the console switch or a tiered console switch, the port numbering displays the ARI port first, then the switch port to which the server is connected. For example, in Figure 3.1, servers 06-01, 06-03, 06-02, 06-04, and 01-02 are connected to tiered switches.

Accessing the Main window

1. Press Print Screen to launch the OSCAR interface. The Main window opens.

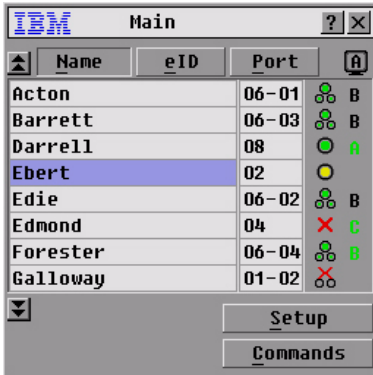

Figure 3.1: Example of Configured Main Window

NOTE: You can also press Ctrl twice within one second to launch the OSCAR interface. You can use this key sequence in any place you see Print Screen throughout this installation and user's guide.

Viewing the status of the switch

The status of the servers in the system is indicated in the right columns of the Main window. The following table describes the status symbols.

Table 3.1: OSCAR Interface Status Symbols







Symbol	Description
	The switch cable is online (green circle).
	The switch cable is offline or is not operating properly.
	The server is tiered through a console switch. The server and the console switch are online and have power.
	The server is tiered through a console switch. The server and the console switch are offline or have no power.
	The switch cable is not operating properly (yellow circle).
	The switch cable is being accessed by the indicated user channel (green channel letter).

Table 3.1: OSCAR Interface Status Symbols (Continued)

A	The switch cable is blocked by the indicated user channel (black channel letter). For instance, in Figure 3.1, user B is viewing Forester, but is blocking access to Acton, Barrett, and Edie, which are connected to the same console switch.
----------	--

Selecting servers

Use the Main window to select servers. When you select a server, the console switch reconfigures the keyboard and mouse to the proper settings for that server.

Double-click the server name or port number.

-or-

If the display order of the server list is by port (Port button is selected), type the port number and press Enter.

-or-

If the display order of the server list is by name (Name button is selected), type the first few characters of the name of the server to establish it as unique and press Enter.

Selecting the previous server

Press Print Screen and then Backspace. This key combination toggles you between the previous and current connections.

Disconnecting the user from a server

Press Print Screen to access OSCAR and then click **Disconnect**.

-or-

Press Print Screen and then Alt+0. The status flag on the desktop displays `Free`. The Free status indicates that the server is not selected for the user.

NOTE: The status flag displays on the desktop and shows the name or the port number of the selected server or the status of the selected port.

NOTE: To clear all directly connected offline switch cables from the list, click **Clear**.

Soft switching

Soft switching is the ability to switch servers using a hotkey sequence. You can soft switch to a server by pressing Print Screen and then typing the first few characters of its name or number. If you have set a **Screen Delay Time** and you press the key sequences before that time has elapsed, the OSCAR interface will not display.

Configuring servers for soft switching

1. Press Print Screen to launch the OSCAR interface. The Main window opens.
2. Click **Setup - Menu**. The Menu window opens.
3. For **Screen Delay Time**, type the number of seconds of delay that you want before the Main window opens after Print Screen is pressed.

4. Click **OK**.

Soft switching to a server

1. To select a server, press Print Screen. If the display order of the server list is by port (Port button is selected), type the port number and press Enter.
-or-
If the display order of the server list is by name (Name button is selected), type the first few characters of the name of the server to establish it as unique and press Enter.
2. To switch back to the previous server, press Print Screen then Backspace.

Navigating the OSCAR Interface

The following table describes how to navigate the OSCAR interface using the keyboard.

Table 3.2: OSCAR Interface Navigation Basics

Action	Result
Print Screen	Press Print Screen twice to send the Print Screen keystroke to the currently selected device.
F1	Opens the Help screen for the current window.
Esc	Closes the current window without saving changes and returns to the previous one. In the Main window, it closes the OSCAR interface and returns to the flag. In a message window, it closes the pop-up window and returns to the current window.
Alt+Hotkey	Opens windows, selects or checks options, and executes actions when used with underlined or other designated letters.
Alt+X	Closes the current window and returns to the previous one.
Alt+O	Selects the OK button, then returns to the previous window.
Enter	Completes a switch in the Main window and exits the OSCAR interface. Click on an editable field to select the text for editing and enable the Left and Right arrow keys to move the cursor. Press Enter to quit the edit mode.
Print Screen Backspace	Toggles back to the previous selection.
Print Screen Alt+0	Immediately disconnects the user from a server and no server is selected. The Status flag displays <code>Free</code> . (This only applies to the 0 on the keyboard and not the keypad.)
Print Screen Pause	Immediately turns on screen saver mode (when screen saver is enabled) and prevents access to that specific console, if it is password protected.
Up/Down Arrows	Moves the cursor from line to line in lists.

Table 3.2: OSCAR Interface Navigation Basics (Continued)

Right/Left Arrows	Moves the cursor between columns. When editing a field, these keys move the cursor within the column.
Page Up/Page Down	Pages up and down through Name and Port lists and Help pages.
Home/End	Moves the cursor to the top or bottom of a list.
Delete	Deletes characters in a field.

Configuring OSCAR Interface Menus

You can configure the console switch from the Setup menu within the OSCAR interface. Select the Names button when initially setting up the console switch to identify servers by unique names. Select the other setup features to manage routine tasks for the servers from the OSCAR menu.

Table 3.3: Setup Features to Manage Routine Tasks for the Servers

Feature	Purpose
Menu	Change the server listing between numerically by port number and alphabetically by name. -or- Change the Screen Delay Time before the OSCAR interface displays after pressing Print Screen.
Flag	Change display, timing, color, or location of the status flag.
Broadcast	Set up to simultaneously control multiple servers through keyboard and mouse actions.
Scan	Set up a custom scan pattern for up to 16 servers.
Security	Set passwords to restrict server access. -or- Enable the screen saver.
Devices	Identify the appropriate number of ports on an attached tiered switch.
Names	Identify servers by unique names.
Switch	Enable share mode. Choose the switch mode and the share mode time-out.
Keyboard	Set a keyboard language for the USB switch cable.

Accessing the Setup menu

1. Press Print Screen to launch the OSCAR interface. The Main window opens.
2. Click **Setup**. The Setup window opens.



Figure 3.2: Setup Window

Assigning server names

Use the Names window to identify individual servers by name rather than by port number. The Names list is always sorted by port order. Names are stored in the switch cable, so even if you move the cable or server to another ARI port, the name and configuration will be recognized by the switch.

NOTE: If a server is turned off, its respective switch cable will not appear in the Names list.

Accessing the Names window

1. Press Print Screen to launch the OSCAR interface. The Main window opens.
2. Click **Setup - Names**. The Names window opens.

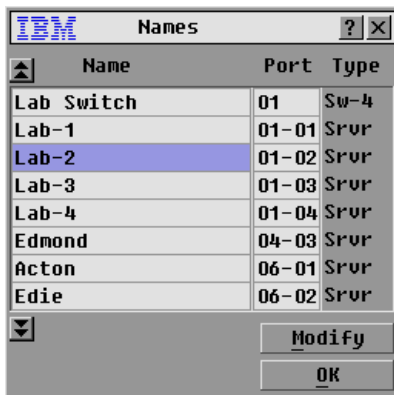

Figure 3.3: Names Window

NOTE: If the server list changes, the mouse cursor will turn into an hourglass as the list is automatically updated. No mouse or keyboard input will be accepted until the list update is complete.

Assigning names to servers

1. In the Names window, select a server name or port number and click **Modify**. The Name Modify window opens.

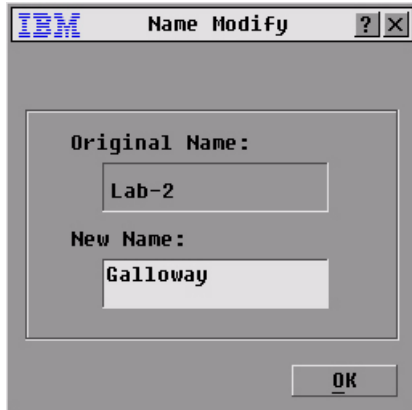

Figure 3.4: Name Modify Window

2. Type a name in the **New Name** field. Names of servers can be up to 15 characters long. Valid characters include: A to Z, a to z, 0 to 9, space, and hyphen.
3. Click **OK** to transfer the new name to the Names window. The selection is not saved until you click **OK** in the Names window.
4. Repeat steps 1 to 3 for each server in the system.
5. Click **OK** in the Names window to save the changes.
-or-
Click **X** or press Esc to exit the window without saving changes.

NOTE: If a switch cable has not been assigned a name, “PS/2 cable” or “USB cable” is used as the default name.

Assigning device types

The console switch automatically discovers tiered switches, but you will need to specify the number of ports on the tiered switch through the Devices window. You will see an abbreviation of the switch type displayed in the Type category for the tiered switch. Select the switch from the list and the Modify button displays, enabling you to assign it the appropriate number of ports.

NOTE: The Modify button will only be available if a configurable switch is selected.

Accessing the Devices window

1. Press Print Screen to launch the OSCAR interface. The Main window opens.
2. Click **Setup - Devices**. The Devices window opens.



Figure 3.5: Devices Window

When the console switch discovers a tiered switch, the port numbering changes to accommodate each server under that switch. For example, if the switch is connected to ARI port 6, the switch port would be listed as 06 and each server under it would be numbered sequentially 06-01, 06-02 and so on.

Assigning a device type

1. In the Devices window, select the port number.
2. Click **Modify**. The Device Modify window opens.

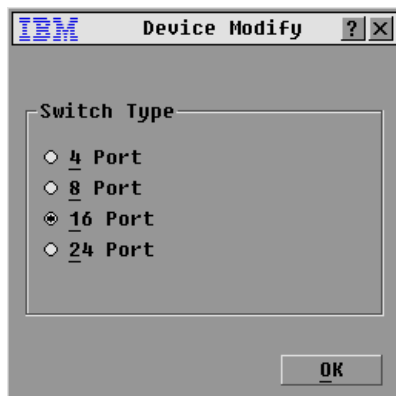

Figure 3.6: Device Modify Window

3. Choose the number of ports supported by the tiered switch and click **OK**.
4. Repeat steps 1 to 3 for each port requiring a device type to be assigned.
5. Click **OK** in the Devices window to save the settings.

NOTE: Changes made in the Device Modify window are not saved until you click **OK** in the Devices window.

Changing the display behavior

Use the Menu window to change the display order of servers and set a **Screen Delay Time** for the OSCAR interface. Changing the display order alters how servers will display in several screens including the Main, Devices, and Broadcast windows.

Accessing the Menu window

1. Press Print Screen to launch the OSCAR interface. The Main window opens.
2. Click **Setup - Menu** in the Main window. The Menu window opens.

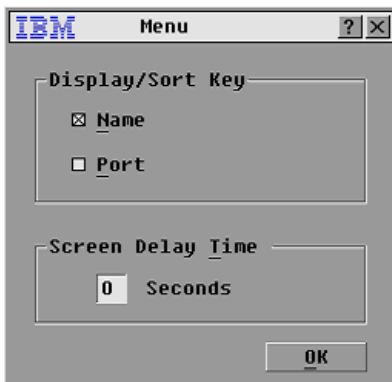

Figure 3.7: Menu Window

Choosing the default display order of servers

1. Select **Name** to display servers alphabetically by name.
-or-
Select **Port** to display servers numerically by port number.
2. Click **OK**.

Setting a Screen Delay Time for the OSCAR interface





1. Type in the number of seconds (0 to 9) to delay the OSCAR interface display after you press Print Screen. Entering 0 will instantly launch the OSCAR interface with no delay.
2. Click **OK**.

Setting a **Screen Delay Time** enables you to complete a soft switch without the OSCAR interface displaying. To perform a soft switch, see “Soft switching” on page 19.

Controlling the status flag

The status flag displays on the desktop and shows the name or the port number of the selected server or the status of the selected port. Use the Flag window to configure the flag to display by server name or port number, or to change the flag color, opacity, display time, and location on the desktop.

Table 3.4: OSCAR Interface Status Flags

Flag	Description
	Flag type by name.
	Flag type by port number.
	Flag indicating that the user has been disconnected from all systems.
	Flag indicating that Broadcast mode is enabled.
	Flag indicating that the user is in share mode.

Accessing the Flag window

1. Press Print Screen. The Main window opens.
2. Click **Setup - Flag**. The Flag window opens.



Figure 3.8: Flag Window

Determining the display of the status flag

1. Select **Name** or **Port** to determine what information will be displayed.
2. Select **Displayed** to show the flag all the time or select **Timed** to display the flag for only five seconds after switching.
3. Select a flag color in the **Display Color** area.
4. In the **Display Mode** area, select **Opaque** for a solid color flag or select **Transparent** to see the desktop through the flag.
5. To position the status flag on the desktop:
 - a. Click **Set Position** to gain access to the Set Position window.
 - b. Left-click on the title bar and drag to the location that you want.
 - c. Right-click to return to the Flag window.

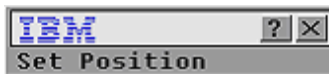

Figure 3.9: Set Position Window

NOTE: Changes made to the flag position are not saved until you click **OK** in the Flag window.

6. Click **OK** to save the settings.
-or-
Click **X** to exit without saving changes.

Setting console switch security

The OSCAR interface enables you to set security on the local port console. You can establish a screen saver mode that engages after the console switch remains unused for a specified Inactivity Time. Once engaged, the console switch will remain locked until you press any key or move the mouse. You will then need to type in the password to continue.

Use the Security window to lock the console switch with password protection, set or change the password, and enable the screen saver.

NOTE: If a password has been previously set, you will have to enter the password before you can access the Security window.

Accessing the Security window

1. Press Print Screen to launch the OSCAR interface. The Main window opens.
2. Click **Setup - Security**. The Security window opens.



Figure 3.10: Security Window

Setting or changing the password

1. Click in the **New** field and press Enter or double-click in the **New** field.
2. Type the new password in the **New** field and press Enter.
Passwords must contain alphanumeric characters, are case sensitive, and can be up to 12 characters. Valid characters are: A to Z, a to z, 0 to 9, space, and hyphen.
3. In the **Repeat** field, type the password again and press Enter.
4. Click **OK** and then close the window.

NOTE: If you lose or forget the password, call technical support. See "Appendix C: Technical Support" for contact information.

Password protecting the console

1. Set the password as described in the previous procedure.
2. Select **Enable Screen Saver**.
3. Type the number of minutes for Inactivity Time (from 1 to 99) to delay activation of password protection and the screen saver feature.
4. For Mode, select **Energy** if the monitor is ENERGY STAR[®] compliant, otherwise select **Screen**.

ATTENTION: Monitor damage can result from the use of Energy mode with monitors not compliant with ENERGY STAR.

5. (Optional) Click **Test** to activate the screen saver test, which lasts 10 seconds then returns you to the Security window.
6. Click **OK**.

Logging in to the console

1. Press any key or move the mouse.
2. The Password window opens. Type the password, then click **OK**.
3. The Main window opens if the password was entered correctly.

Removing password protection from the console

1. From the Main window, click **Setup - Security**; the Password window opens. Type the password, then click **OK**.
2. In the Security window, click in the **New** field and press Enter or double-click in the **New** field. Leave the field blank. Press Enter.
3. Click in the **Repeat** field and press Enter or double-click in the **Repeat** field. Leave the field blank. Press Enter.
4. Click **OK** to eliminate the password.

Enabling the screen saver mode with no password protection

1. If the console switch does not require a password to gain access to the Security window, proceed to step 2.
-or-
If the console switch is password protected, see the previous procedure, then go to step 2.
2. Select **Enable Screen Saver**.
3. Type the number of minutes for Inactivity Time (from 1 to 99) to delay activation of the screen saver.
4. Choose **Energy** if the monitor is ENERGY STAR compliant; otherwise select **Screen**.

ATTENTION: Monitor damage can result from the use of Energy mode with monitors not compliant with ENERGY STAR.

5. (Optional) Click **Test** to activate the screen saver test which lasts 10 seconds then returns you to the Security window.
6. Click **OK**.

NOTE: Activation of the screen saver mode disconnects the user from a server; no server is selected. The status flag displays `Free`.

Exiting the screen saver mode

Press any key or move the mouse. The Main window opens and any previous server connection will be restored.

Turning off the screen saver

1. In the Security window, clear the **Enable Screen Saver** check box.
2. Click **OK**.

Turning on the screen saver

After the screen saver is enabled, press Print Screen, then press Pause.

Displaying Version Information

The OSCAR interface enables you to display the versions of the console switch firmware and the switch cable hardware. For optimum performance, keep the console switch firmware current. For more information, see “Appendix A: Firmware Upgrades.”

1. Press Print Screen. The Main window opens.
2. Click **Commands - Display Versions**. The Version window opens. The top half of the window lists the subsystem versions in the console switch.



Figure 3.11: Version Window

- Click the Cable button to view the version information for the cable hardware. The Cable Selection window opens.

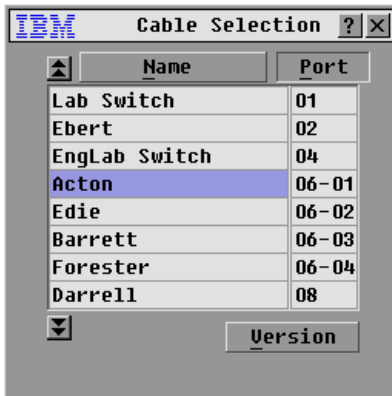

Figure 3.12: Cable Selection Window

- Select a switch cable to view and click the Version button. The Cable Version window opens. Note that the switch cables are not upgradeable and the version information is displayed for technical support purposes only.
- Click X to close the Cable Version window.

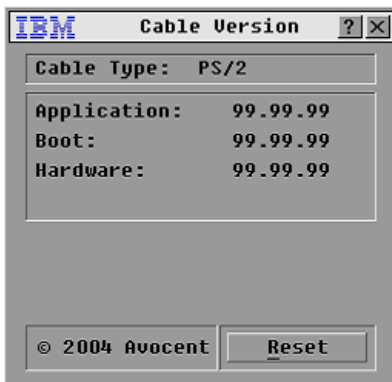

Figure 3.13: Cable Version Window

NOTE: You can use the Reset button to reset the PS/2 switch cable. This activity is only relevant when the console switch system involves a PS/2 switch cable attached to a tiered switch. On these occasions, you might need to reset the PS/2 switch cable when the tiered switch is not recognized. If a reset is performed when a console switch is connected directly to a server and not a tiered switch, the mouse/keyboard might fail to respond. When this occurs, the target server requires a restart.

Resetting a switch cable

1. Press Print Screen. The Main window opens.
2. Click **Commands - Display Versions**. The Version window opens.
3. Click **Cable**. The Cable Selection window opens.
4. Select the switch cable that you want to view and click **Version**. The Cable Version window opens.
5. Click **Reset**. A warning message appears, warning that the function is for tiered switches only and that resetting the cable can result in the need to restart the target server.
6. Click **OK** to proceed with the reset.
-or-
Press Esc to exit.

Resetting the Keyboard and Mouse

If a keyboard or mouse locks up, you might be able to reestablish operation of these peripheral devices by issuing a reset command.

1. Press Print Screen. The Main window opens.
2. Click **Commands - Device Reset**. A message window opens requesting that you confirm the reset.
3. Click **OK**. A message window opens indicating that the mouse and keyboard are reset.
4. Click **X** to close the message window.

Scanning the System

In scan mode, the console switch automatically scans from port to port (server to server). You can scan up to 16 servers, specifying which servers to scan and the number of seconds that each server will display. The scanning order is determined by the order in which the servers are added to the list. The port name or port number of the server can be displayed by pressing the appropriate button.

Adding servers to the scan list

1. If the OSCAR interface is not open, press Print Screen. The Main window opens.
2. Click **Setup - Scan**. The Scan window opens.

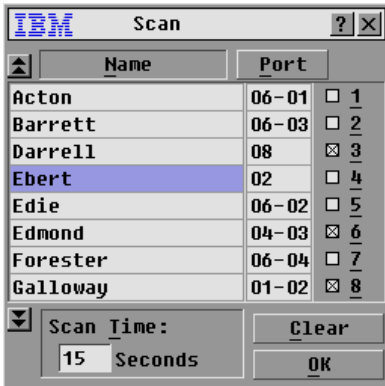

Figure 3.14: Scan Window

- The Scan window contains a listing of all servers attached to the console switch. Click the check box next to the servers you want to scan.
-or-
Double-click on the name or port of a server.
-or-
Press Alt and the number of the server you want to scan. You can select up to 16 servers from the entire list.
- In the **Scan Time** field, type the number of seconds (from 3 to 255) of time before the scan moves to the next server in the sequence.
- Click **OK**.

Removing a server from the scan list

- In the Scan window, clear the check box next to the server to be removed.
-or-
Double-click on the name or port of the server.
-or-
Click the Clear button to remove all servers from the scan list.
- Click **OK**.

Setting the scan duration

Type a value in the **Scan Time** field. The duration you type must be a minimum of 3 seconds and a maximum of 255 seconds.

Starting the scan mode

- If the OSCAR interface is not open, press Print Screen. The Main window opens.
- Click **Commands**. The Commands window opens.



Figure 3.15: Commands Window

3. Select **Scan Enable** in the Commands window.
4. Click **X** to close the Commands window.

NOTE: Scanning will begin when the Main window or flag is displayed. Scanning is not permitted in any other OSCAR interface window.

Canceling scan mode

1. Select a server if the OSCAR interface is open.
-or-
Move the mouse or press any key on the keyboard if the OSCAR interface is not open.
Scanning will stop at the currently selected server.
-or-
Press Print Screen. The Main window opens.
2. Click **Commands**. The Commands window opens.
3. Clear the **Scan Enable** check box.

Broadcasting to Servers

The local user can simultaneously control more than one server in a system, to make sure that all selected servers receive identical input. You can choose to broadcast movements of keystrokes and mouse movements independently. You can broadcast to up to 16 servers at a time, one server per ARI port.

Accessing the Broadcast window

1. Press Print Screen. The Main window opens.
2. Click **Setup - Broadcast**. The Broadcast window opens.



Figure 3.16: Broadcast Window

NOTE: Broadcasting Keystrokes - The keyboard state must be identical for all servers receiving a broadcast to interpret keystrokes identically. Specifically, the Caps Lock and Num Lock modes must be the same on all keyboards. While the console switch attempts to send keystrokes to the selected servers simultaneously, some servers can block and thereby delay the transmission.

NOTE: Broadcasting Mouse Movements - For the mouse to work accurately, all systems must have identical mouse drivers, desktops (such as identically placed icons) and video resolutions. In addition, the mouse must be in exactly the same place on all screens. Because these conditions are extremely difficult to achieve, broadcasting mouse movements to multiple systems can have unpredictable results.

Broadcasting to selected servers

- From the Broadcast window, select one or both keyboard and mouse check boxes for the servers that are to receive the broadcast commands.
-or-
Press the Up or Down Arrow keys to move the cursor to the target server. Then press Alt+K to select the keyboard check box and Alt+M to select the mouse check box. Repeat for additional servers.
- Click **OK** to save the settings and return to the Setup window. Click **X** or press Esc to return to the Main window.
- Click **Commands**. The Commands window opens.
- Click the **Broadcast Enable** check box to activate broadcasting. The Broadcast Enable window opens.



Figure 3.17: Broadcast Enable Window

5. Click **OK** to enable the broadcast. Click **X** or press Esc to cancel and return to the Commands window.
6. If broadcasting is enabled, type the information and perform the mouse movements you want to broadcast from the user station.

NOTE: The other user is disabled when broadcast mode is enabled. Only servers in the list are accessible.

Turning broadcasting off

From the Commands window, clear the **Broadcast Enable** check box.

Changing the Switch Mode

The console switch enables you to connect to attached servers using two methods: Preemptive and Cooperative.

Select **Preemptive** (default setting) to enable the other user to select any server at any time; a request from the other user disconnects the current user without warning.

-or-

Select **Cooperative** to maintain the current user connection; the current user will not be disconnected if the other user requests connection.

From the Switch screen you can also enable or disable the Share mode and specify the time-out period.

Accessing the Switch window

1. Press Print Screen. The Main window opens.
2. Click **Setup - Switch**. The Switch window opens.

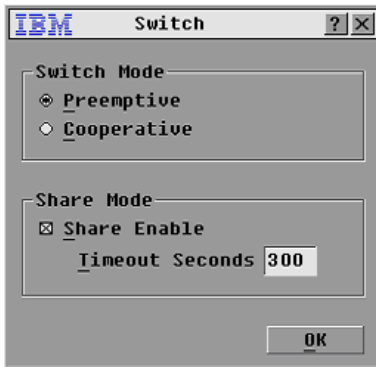

Figure 3.18: Switch Window

3. Select either **Preemptive** or **Cooperative** as the switch mode.
4. Select **Share Enable**, then specify the share time-out period in seconds.
5. Click **OK** to save the Switch Mode and Share Mode settings.

Setting the Keyboard Country Code

The console switch enables you to set the keyboard country code servers for the Sun server with USB ports.

Setting the keyboard country code

1. Press Print Screen. The Main window opens.
2. Click **Setup - Keyboard**. The Keyboard window opens.



Figure 3.19: Keyboard Window

3. Select the keyboard country code for the Sun servers. Click **OK**. The Keyboard Warning window opens.

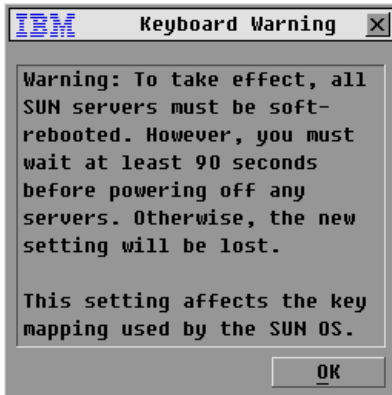

Figure 3.20: Keyboard Warning Window

4. Click **OK** on the Keyboard Warning window to save the keyboard country code setting.

Appendix A: Firmware Upgrades

Upgrading the console switch

You can upgrade the firmware of the console switch by using a special update utility. This utility automatically configures the port communications settings to enable direct downloading from the connected server.

Items needed for the upgrade

The following items are required to upgrade the console switch firmware:

- Server running Microsoft® Windows® NT®, Windows 95, Windows 98, Windows 2000, Windows 2003
- Available serial port (COM port) on the server
- Standard serial cable that connects the switch and the server
- Firmware update

Upgrading firmware

1. Connect a standard serial cable to a COM port on the server and to the serial connector on the back panel of the switch. Make a note of which COM port you have chosen, then turn on the switch.
2. Go to <http://www.ibm.com/pc/support> and click on **Downloads and drivers**. Search on the product name to access the firmware upgrade file. After the download is complete, navigate to the drive where you have saved the firmware update and unzip the file.
3. Double-click to run the file WUpDate.exe.
4. In the window that opens, select the language and COM port.
5. Click **Load**.
6. After the firmware is updated, the following message displays `Download complete`. Click **Done** to exit the window.
7. The switch automatically restarts after the upgrade is completed.

Possible error conditions

If the download does not execute properly, verify the following:

- The COM port is correct.
- No other program is currently using the COM port, or that a previous DOS window or shell is open that had used the COM port.
- No other copies of the WUpDate utility are currently running.

- A standard serial cable is used.
- In the selected COM port Advanced Port settings, verify that the FIFO buffers are selected and that the receive buffer is set to High.

ATTENTION: While upgrading, do not use the server for anything else or switch between windows. Close all other windows if necessary. If the upgrade was unsuccessful (such as during a power outage), repeat the procedure.

Appendix B: Technical Specifications

Table B.1: Console Switch Product Specifications

Product Specifications	
Server Ports	
Number	8 (1x8 console switch), 16 (2x16 console switch)
Cable Types	USB and PS/2
Connectors	RJ-45
Sync Types	Separate horizontal and vertical
Plug and Play	DDC2B
Video Resolution	Local Port Maximum 1280 x 1024 @ 75 Hz
Update Port	
Number	1
Type	Serial RS-232
Connector	DB-9 Male
Local Port Sets	
Number	1 (1x8 console switch), 2 (2x16 console switch)
Type	PS/2, VGA and ACI (ACI port available only for User A)
Connectors	2 PS/2 MiniDIN 6, 1 HD15
Dimensions	
Dimensions (H x W x D)	4.45 cm x 43.18 cm x 27.94 cm 1 U form factor (1.75 in x 17.00 in x 11.00 in)
Weight	3.6 kg (8 lb) without cables
Heat Dissipation	92 Btu/Hr
Airflow	8 CFM
Power Consumption	12.5 Watts
AC-input power	40 Watts maximum
AC-input voltage rating	100 to 240 V ac Autosensing
AC-input current rating	0.5 A
AC-input cable	18 AWG three-wire cable, with a three-lead IEC-320 receptacle on the power supply end and a country or region dependent plug on the power resource end
AC-frequency	50 - 60 Hz
Temperature	0° to 50° C (32° to 122° F) operating -30° to 60° C (-22° to 140° F) transit -20° to 60° C (-4° to 140° F) storage
Humidity	20% to 80% noncondensing operating 5% to 95% noncondensing nonoperating
Product Safety Standards	
UL 60950-1, CSA C22.2 No. 60950-1, and EN 60950-1	

Appendix C: Notices

This information was developed for products and services offered in the U.S.A.

IBM may not offer the products, services, or features discussed in this document in other countries. Consult your local IBM representative for information on the products and services currently available in your area. Any reference to an IBM product, program, or service is not intended to state or imply that only that IBM product, program, or service may be used. Any functionally equivalent product, program, or service that does not infringe any IBM intellectual property right may be used instead. However, it is the user's responsibility to evaluate and verify the operation of any non-IBM product, program, or service.

IBM may have patents or pending patent applications covering subject matter described in this document. The furnishing of this document does not give you any license to these patents. You can send license inquiries, in writing, to:

*IBM Director of Licensing
IBM Corporation
North Castle Drive
Armonk, NY 10504-1785
U.S.A.*

INTERNATIONAL BUSINESS MACHINES CORPORATION PROVIDES THIS PUBLICATION "AS IS" WITHOUT WARRANTY OF ANY KIND, EITHER EXPRESS OR IMPLIED, INCLUDING, BUT NOT LIMITED TO, THE IMPLIED WARRANTIES OF NON-INFRINGEMENT, MERCHANTABILITY OR FITNESS FOR A PARTICULAR PURPOSE. Some states do not allow disclaimer of express or implied warranties in certain transactions, therefore, this statement may not apply to you.

This information could include technical inaccuracies or typographical errors. Changes are periodically made to the information herein; these changes will be incorporated in new editions of the information. IBM may make improvements and/or changes in the product(s) and/or the program(s) described in this publication at any time without notice.

Any references in this information to non-IBM Web sites are provided for convenience only and do not in any manner serve as an endorsement of those Web sites. The materials at those Web sites are not part of the materials for this IBM product, and use of those Web sites is at your own risk.

IBM may use or distribute any of the information you supply in any way it believes appropriate without incurring any obligation to you.

Edition notice

© **Copyright International Business Machines Corporation 2005. All rights reserved.**

U.S. Government Users Restricted Rights — Use, duplication, or disclosure restricted by GSA ADP Schedule Contract with IBM Corp.

Trademarks

The following terms are trademarks of International Business Machines Corporation in the United States, other countries, or both:

IBM

IBM (logo)

NetBAY

PS/2

ServerProven

Microsoft, Windows, and Windows NT are trademarks of Microsoft Corporation in the United States, other countries, or both.

Other company, product, or service names may be trademarks or service marks of others.

Important notes

IBM makes no representation or warranties regarding non-IBM products and services that are ServerProven®, including but not limited to the implied warranties of merchantability and fitness for a particular purpose. These products are offered and warranted solely by third parties.

IBM makes no representations or warranties with respect to non-IBM products. Support (if any) for the non-IBM products is provided by the third party, not IBM.

Some software may differ from its retail version (if available), and may not include user manuals or all program functionality.

Product recycling and disposal

This unit contains materials such as circuit boards, cables, electromagnetic compatibility gaskets, and connectors which may contain lead and copper/beryllium alloys that require special handling and disposal at end of life. Before this unit is disposed of, these materials must be removed and recycled or discarded according to applicable regulations. IBM offers product-return programs in several countries. Information on product recycling offerings can be found on IBM's Internet site at <http://www.ibm.com/ibm/environment/products/prp.shtml>.

IBM encourages owners of information technology (IT) equipment to responsibly recycle their equipment when it is no longer needed. IBM offers a variety of programs and services to assist equipment owners in recycling their IT products. Information on product recycling offerings can be found on IBM's Internet site at <http://www.ibm.com/ibm/environment/products/prp.shtml>.

Appendix D: Electronic Emission Notices

Federal Communications Commission (FCC) statement

Note: This equipment has been tested and found to comply with the limits for a Class A digital device, pursuant to Part 15 of the FCC Rules. These limits are designed to provide reasonable protection against harmful interference when the equipment is operated in a commercial environment. This equipment generates, uses, and can radiate radio frequency energy and, if not installed and used in accordance with the instruction manual, may cause harmful interference to radio communications. Operation of this equipment in a residential area is likely to cause harmful interference, in which case the user will be required to correct the interference at his own expense.

Properly shielded and grounded cables and connectors must be used in order to meet FCC emission limits. IBM is not responsible for any radio or television interference caused by using other than recommended cables and connectors or by unauthorized changes or modifications to this equipment. Unauthorized changes or modifications could void the user's authority to operate the equipment.

This device complies with Part 15 of the FCC Rules. Operation is subject to the following two conditions: (1) this device may not cause harmful interference, and (2) this device must accept any interference received, including interference that may cause undesired operation.

Industry Canada Class A emission compliance statement

This Class A digital apparatus complies with Canadian ICES-003.

Avis de conformité à la réglementation d'Industrie Canada

Cet appareil numérique de la classe A est conforme à la norme NMB-003 du Canada.

Australia and New Zealand Class A statement

Attention: This is a Class A product. In a domestic environment this product may cause radio interference in which case the user may be required to take adequate measures.

United Kingdom telecommunications safety requirement

Notice to customers

This apparatus is approved under approval number NS/G/1234/J/100003 for indirect connection to public telecommunication systems in the United Kingdom.

European Union EMC Directive conformance statement

This product is in conformity with the protection requirements of EU Council Directive 89/336/EEC on the approximation of the laws of the Member States relating to electromagnetic compatibility. IBM cannot accept responsibility for any failure to satisfy the protection requirements resulting from a nonrecommended modification of the product, including the fitting of non-IBM option cards.

This product has been tested and found to comply with the limits for Class A Information Technology Equipment according to CISPR 22/European Standard EN 55022. The limits for Class A equipment were derived for commercial and industrial environments to provide reasonable protection against interference with licensed communication equipment.

ATTENTION: This is a Class A product. In a domestic environment this product may cause radio interference in which case the user may be required to take adequate measures.

Taiwan Class A warning statement

警告使用者：
這是甲類的資訊產品，在
居住的環境中使用時，可
能會造成射頻干擾，在這
種情況下，使用者會被要
求採取某些適當的對策。

Chinese Class A warning statement

声 明
此为 A 级产品。在生活环境中，
该产品可能会造成无线电干扰。
在这种情况下，可能需要用户对其
干扰采取切实可行的措施。

Japanese Voluntary Control Council for Interference (VCCI) statement

この装置は、情報処理装置等電波障害自主規制協議会（VCCI）の基準に
基づくクラスA情報技術装置です。この装置を家庭環境で使用すると電波妨害を
引き起こすことがあります。この場合には使用者が適切な対策を講ずるよう要求
されることがあります。

INDEX**A**

ARI ports 1
assigning device types 23
assigning server names 22

B

broadcast
 to selected servers 35

C

canceling scan mode 34
changing the Switch mode 36
console
 logging in 29
 password protecting 29
 removing password protection 29
console switch
 1x8 model 1
 2x16 model 1
 basic configuration 12
 connecting to servers 11
 installing 11
 rack mounting 9
 supplied with 9
 technical specifications 41
 tiered switch configuration 13
 tiering 10
 upgrading 39
 viewing status 18
console switch (PS/2) 1

console switch (USB) 2
console switch cable
 connecting 12

D

device types
 assigning 23
display behavior 25

E

earlier-model console switches 3

F

firmware upgrades 3, 39

I

IBM Console Switch
 features 1
 resolution and refresh rates 1

K

Keep Alive 1
keyboard and mouse
 resetting 32
KVM connectivity 1

L

local ports
 controlling system at 17

N

Notices 42

O

- OSCAR interface 1, 2
 - Broadcast window 35
 - configuring menus 21
 - Menu window 25
 - navigation basics 20
 - setting Screen Delay Time 25
 - status flags 26

P

- password
 - protecting 29
 - setting or changing 28
- password protecting 28
- peripheral devices
 - connecting 12
- Plug and Play 3
- ports and servers
 - viewing and selecting 17

R

- rack mounting 7
 - horizontal installation 10
 - vertical installation 9
- resetting keyboard and mouse 32

S

- scan list
 - removing a server 33
- screen saver mode 29
- security 2
- server

- adding to scan list 32
- configuring for soft switching 19
- disconnecting users 19
- removing from scan list 33
- soft switching to 20

- server names
 - assigning 22
- servers 17
- setting scan duration 33
- setting security 28
- soft switching 19
- starting scan mode 33
- status flag
 - controlling 19, 26

SVGA 2

- switch cable
 - status 18
- Switch mode 36

T

- technical specifications 41
- tiering
 - multiple console switches 13
- turning off screen saver 30

V

- version information 30
- VESA DDC2B 3
- VGA 2
- video 2

X

- XGA 2

